



COMPETITION

WIN A PRODUCT BUNDLE WORTH

OVER **£950!**

SEE PAGE 5



SPRING ESSENTIALS

INCLUDING CLEANING & CLIMATE RANGES!

NEW MULTI-PROCESS MIG/ARC/TIG WELDERS
PAGES 44-47



NEW BELT-DRIVE COMPRESSORS
SEE PAGES 84-88



											
P6 - P9	P10 - P21	P22- P25	P26 - P29	P30 - P43	P44 - P63	P64 - P77	P78 - P106	P107 - P118	P119-127	P128 - P135	P136 - P139
CLIMATE CONTROL & VENTILATION	CLEANING	WATER PUMPS	POWER GENERATORS	METALWORK	WELDING, PLASMA & FUME EXTRACTION	WOODWORK	COMPRESSORS & AIR TOOLS	HYDRAULIC & AUTOMOTIVE	BOOSTERS, CHARGERS & STARTERS	INDOOR & OUTDOOR HEATING	Tigren EQUIPMENT

Welcome to our Spring 2024 issue

SIP INDUSTRIAL PRODUCTS LIMITED

For over 55 years, SIP Industrial Products Limited has been a flagship supplier of high-quality equipment and machinery to the ever-growing engineering, construction, automotive & agricultural marketplaces.

As an ISO 9001 approved machinery specialist, SIP offer quality, value and choice, making sure you have the right product for the task in hand.

This Spring 2024 issue is packed full of new and seasonal products, as well as some amazing package deals!



NEW PRODUCTS

SIP BELT-DRIVEN PISTON AIR COMPRESSORS

PAGES 84-88
FOR MORE INFO



Our latest range of belt drive air compressors offer improved performance and greater functionality for reliable output in demanding applications.

- Larger pumps deliver higher airflow and fill the receiver more quickly
- Belt guard design offers improved airflow and cooling
- All operate from a 13A supply for added flexibility
- Extra-large wheels with U-style pull handle for great mobility
- Ideal for applications in automotive, agricultural and engineering settings



Aftercooler reduces moisture for improved air quality

Larger pump with 14CFM Piston Displacement & 10CFM Free Air Delivery

Adjustable air regulators with quick-release couplers

Belt guard improves airflow and pump cooling

Pressure switch and tank pressure gauge



PRICE FROM
£499.99
EX.VAT

06477 SIP BD 3HP 200ltr

Extra-large durable wheels

Heavy-duty motor 3HP/2.2kW

Air receiver ball valve allows maximum air flow from the receiver



06456 SIP BD 3HP 50ltr

06458 SIP BD 3HP 100ltr

06476 SIP BD 3HP 150ltr

TO PLACE AN ORDER: ☎ 01509 500500

NEW PRODUCTS



Our latest range of MIG welders are all compliant with Regulation EU 2019/1784 (Eco Design for Welding Equipment).

Featuring 4th generation inverters, using power efficiently whilst delivering high quality welding. Our comprehensive range is suitable for entry level users, light industry, automotive environments and professional fabrication workshops.

SIP WELDMATE®

Our range of WELDMATE® welders are powerful and compact and ideal for entry level users and light industry applications.

- Input supply from 13A (230v) or 16A (230v)
- Suitable for gasless and gas MIG welding applications
- Infinitely variable dials for greater welding control
- Ready to weld straight from the box



PAGE 44
FOR MORE INFO

PRICE FROM

£109.99

EX.VAT

SIP WELDMATE® AUTOPLUS

SIP's WELDMATE® AUTOPLUS welders are specifically designed for use in automotive environments. This range features a variety of powerful output capabilities to meet demanding applications.

- Multi-process MIG/ARC/TIG welders for added flexibility
- Features synergic control for efficient, high-quality welding
- Intuitive soft touch control panel with twin LED output displays
- Available with 3-Tier Cart and Large Cylinder Welding Trolley



PAGES 45-46
FOR MORE INFO

PRICE FROM

£249.99

EX.VAT



SIP WELDMATE® PRO

Designed for use in professional fabrication workshops, the WELDMATE® PRO range offers outstanding durability and functionality to meet the requirements of workshop environments.

- Multi-process MIG/ARC/TIG welders for added flexibility
- High output and duty cycles for longer, continuous welding
- Features synergic control for efficient, high-quality welding
- Available with MIG pulse functionality for greater precision & welding control

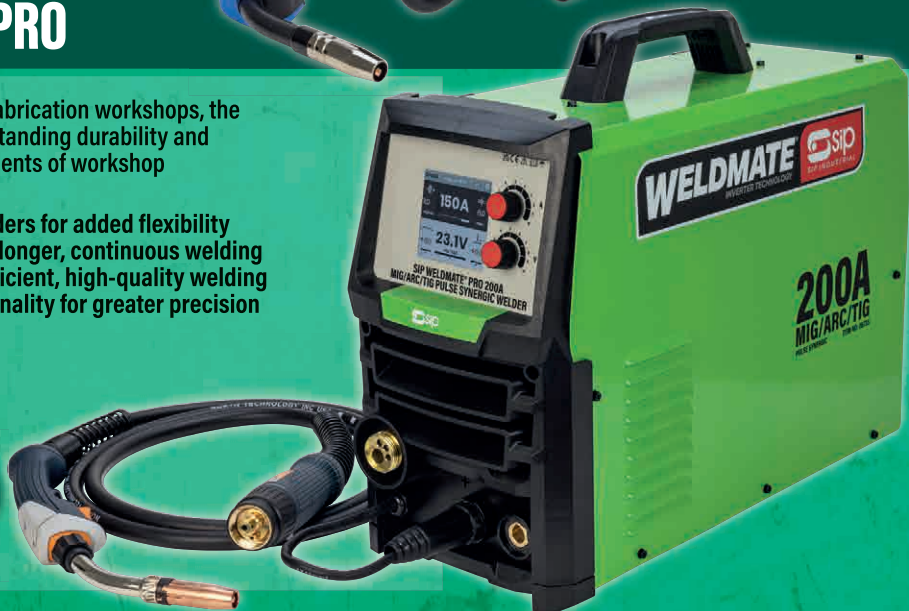

PAGE 47
FOR MORE INFO

PRICE FROM

£499.99

EX.VAT



TO PLACE AN ORDER: www.sip-group.com

NEW PRODUCTS



SIP CLIMATE CONTROL RANGE

SIP 5-in-1 AIR CONDITIONER

This multi-purpose, mobile air conditioning unit features higher cooling and heating outputs for a variety of indoor spaces.

Featuring five low noise operating modes:

- COOLING
- FAN
- DEHUMIDIFYING
- HEATING
- AUTO

This versatile units offer year-round application use.



Easy-to-use touch screen controls and remote control



A front panel LED display indicates room temperature and is visible at night or in darkened rooms.

PAGE 6
FOR MORE INFO

PRICE
£429.99
EX.VAT



MASSIVE
14,000BTU/hr
COOLING CAPACITY

SIP FLOOR, DRUM FANS & VENTILATORS

PRICE FROM
£49.99
EX.VAT

Our range of heavy-duty floor and drum fans are mounted on sturdy steel frames, offering powerful performance and outstanding mobility.

NEW Products! The new oscillating pedestal fan is fixed to a heavy-duty weighted steel base for stability, which has a height adjustable stand, whilst the new orbital floor fan can rotate 360° on its horizontal axis and 360° on its vertical axis to create 720° coverage of air circulation.

Our range also includes higher motor power options making them ideal for industrial applications.

PAGES 7-9
FOR MORE INFO



TO PLACE AN ORDER: ☎ 01509 500500



COMPETITION



PRIZE BUNDLE INCLUDES:

- 1x SIP 4-in-1 Air Conditioner (05647)
- 1x SIP 16" Heavy-Duty Floor Fan (05632)
- 1x SIP CW2000 Electric Pressure Washer (08970)
- 1x SIP 2-in-1 Table Saw with Integrated Dust Extractor (01513)

**WIN THIS MEGA
SPRING BUNDLE**

**WORTH OVER
£950!**

HOW TO ENTER

STEP 1 "FOLLOW US" ON FACEBOOK, INSTAGRAM OR TWITTER (@SIPINDUSTRIAL) & LIKE OR COMMENT ON OUR PINNED COMPETITION POST. IF YOU FOLLOW US ON ALL 3 PLATFORMS, THIS WILL COUNT AS 3 ENTRIES!

BONUS ENTRY SIMPLY SCAN THE QR CODE HERE & SIGN UP. YOU'LL BE AMONGST THE FIRST TO HEAR ABOUT NEW COMPETITIONS, PRODUCTS & PROMOTIONS FROM SIP!



**SCAN
HERE**

Prize bundle value is based on Inc. VAT prices.
This competition will end on June 30th 2024. Any entries after this date will not be counted.
For full competition T&C's. Please visit: sip-group.com/competitions

f X @sipindustrial

SIP AIR CONDITIONERS



SIP 4-in-1 AIR CONDITIONER

Designed to effectively circulate cool and hot air to maintain a consistent temperature in a variety of indoor spaces, including homes, offices and workshops.

Featuring four low noise operating modes, the 4-in-1 Air Conditioner can function as an air conditioner, dehumidifier, cooling fan and heater offering year-round application use.

HEATING MODE - delivers an adjustable output of 8,000BTU/hr for max. temp of 31°C

COOL MODE - offers an adjustable target temperature down to 15°C

DEHUMIDIFIER MODE - max. capacity of 1.2ltr/hr

FAN MODE - operates as a cooling fan without engaging the climate control functions

Remote control - allows the dehumidifier to be operated at distance for added user convenience

DEHUMIDIFYING CAPACITY	1.2ltr/hr (30°C 80%) / 0.6ltr/hr (27°C 60%)
COOLING CAPACITY	10,000 BTU/hr (2.9kW)
HEATING CAPACITY	8,000 BTU/hr (2.3kW)
MAX. AIR FLOW / AREA	380m ³ /hr / 18mtr ²
GAS TYPE	Refrigerant R290 210g
LOW NOISE LEVEL	65dB(A)

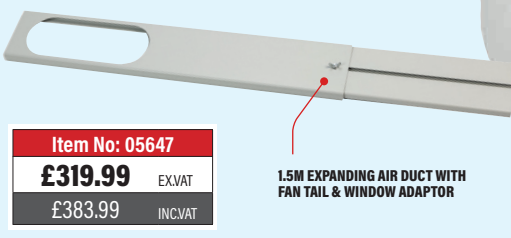

Item No: 05647
£319.99 EX.VAT
 £383.99 INC.VAT

1.5M EXPANDING AIR DUCT WITH FAN TAIL & WINDOW ADAPTOR

AUTO-SWING FOR LARGER AIR COVERAGE



10,000BTU/hr
 COOLING CAPACITY

4x CASTOR WHEELS FOR EASY MOVEMENT



EASY-TO-USE ELECTRONIC TOUCH PAD CONTROL PANEL & REMOTE CONTROL



SIP 5-in-1 AIR CONDITIONER

This multi-purpose, mobile air conditioning unit features higher cooling and heating outputs for a variety of indoor spaces. Featuring five low noise operating modes including cooling, heating, dehumidify, fan and automatic this versatile units offer year-round application use.

COOL MODE offers an adjustable target temperature down to 15°C

HEAT MODE has an adjustable output temperature of up to 31°C temp

DEHUMIDIFIER MODE removes moisture from the air with a max. capacity of 1.5ltr/hr

FAN MODE operates without engaging the climate control functions

AUTO MODE engages the cooling and heating functions as set by the user.

A front panel LED display indicates room temperature and is visible at night or in darkened rooms.

DEHUMIDIFYING CAPACITY	1.5ltr/hr
COOLING CAPACITY	14,000 BTU/hr (4.0kW)
HEATING CAPACITY	10,000 BTU/hr (3.0kW)
MAX. AIR FLOW / AREA	400m ³ /hr
GAS TYPE	Refrigerant R290 260g
LOW NOISE LEVEL	65dB(A)

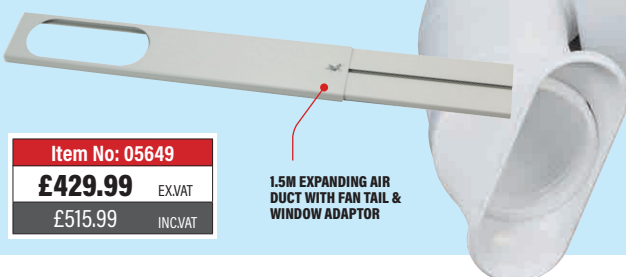

Item No: 05649
£429.99 EX.VAT
 £515.99 INC.VAT

1.5M EXPANDING AIR DUCT WITH FAN TAIL & WINDOW ADAPTOR



MASSIVE
14,000BTU/hr
 COOLING CAPACITY

4x CASTOR WHEELS FOR EASY MOVEMENT



A front panel LED display indicates room temperature and is visible at night or in darkened rooms.

SIP AIR DEHUMIDIFIER



SIP 20 LITRE DEHUMIDIFIER

Our multi-purpose, portable unit is designed to effectively remove excessive air moisture from a variety of indoor spaces.

Featuring five operating modes, this dehumidifier functions to manage humidity levels across a variety of applications for year-round use.

TARGET HUMIDITY MODE - sets the percentage humidity level to reduce moisture in the air

AIR CLEAN MODE - ideal for removing travelling odours, the 2-speed fan can be adjusted for comfort

AUTO MODE - this function sets the air humidity to equal the level in the room or space

DRY CLOTHES MODE - for quick & effective drying applications to draw moisture from clothes and fabrics

DEFROST MODE - perfect for colder rooms and spaces, this setting can automatically engage to ensure a constant temperature

DEHUMIDIFYING RATE	20ltr/day (30°C 80%) / 10ltr/day (27°C 60%)
WATER TANK CAPACITY	6.5ltr
MAX. AIR FLOW	195m ³ /hr
GAS TYPE	Refrigerant R290 60g
LOW NOISE LEVEL	48dB(A)

Item No: 05648
£199.99 EX.VAT
£239.99 INC.VAT



EASY-TO-USE ELECTRONIC TOUCH PAD CONTROL PANEL



SIP AIR VENTILATORS



SCAN HERE

SUPPLY AIR VENTILATION FOR A WIDE RANGE OF INDUSTRIES; WORKSHOPS, BELOW GROUND APPLICATIONS, LOFT SPACES ETC. EFFICIENTLY REMOVE ODOURS AND STALE AIR FROM THE WORK AREAS.

HEAVY-DUTY CONSTRUCTION

EFFECTIVE INTAKE SUCTION

FOR LARGE AIR VOLUME

FRONT & REAR SAFETY GRILLES; FOR ADDITIONAL PROTECTION

05645



05641



SIP VENTILATOR DUCTING

Supplied in 5mtr (10" & 12") & 10mtr (16") lengths, multiple sections can be joined together.

- Concertina design for easy storage
- Heavy-duty PVC construction
- Suitable for SIP Ventilators



Item No: 05642 - 10"
£49.99 EX.VAT
£59.99 INC.VAT

Item No: 05642 - 12"
£52.99 EX.VAT
£63.59 INC.VAT

Item No: 05642 - 16"
£99.99 EX.VAT
£119.99 INC.VAT



Item No	MODEL	INPUT SUPPLY	MOTOR POWER	FAN Ø	FAN SPEED	AIR FLOW (max)	NOISE LEVEL	EX. VAT	INC. VAT
05641	SIP 10" Ventilator	230v	300w	10" (250mm)	2800rpm	2700m ³ /hr	66dB(A)	£119.99	£143.99
05643	SIP 12" Ventilator	230v	500w	12" (300mm)	2800rpm	3900m ³ /hr	69dB(A)	£134.99	£161.99
05645	SIP 16" Ventilator	230v	1100w	16" (400mm)	2800rpm	7200m ³ /hr	79dB(A)	£349.99	£419.99

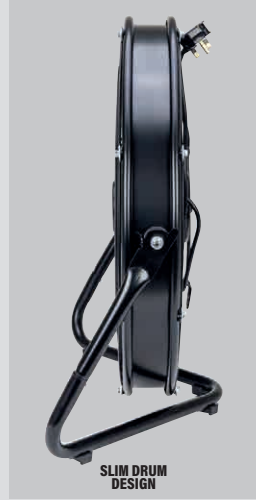
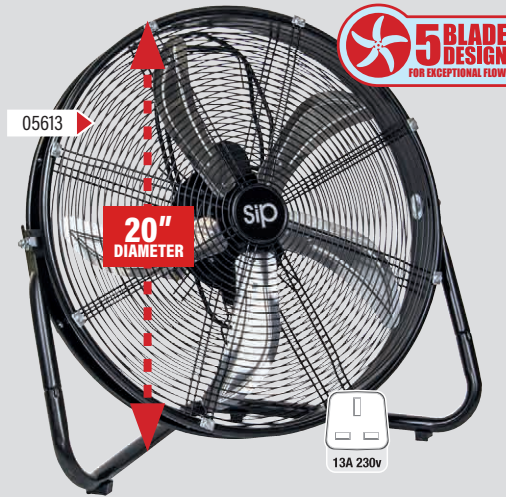
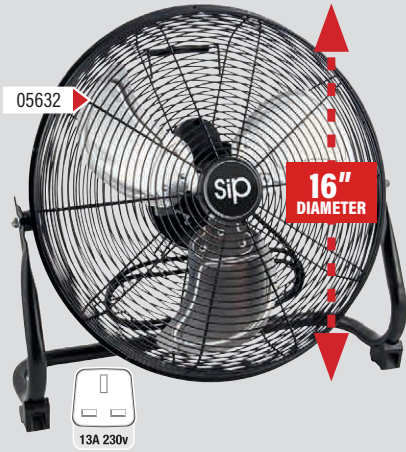

FLOOR STANDING FANS

Our range of floor fans are mounted on balanced and sturdy steel frames that are fully adjustable to 360° rotation for effective air circulation. The new oscillating pedestal fan is fixed to a heavy-duty weighted steel base for stability, which has a height adjustable stand. Whilst, the new orbital floor fan can rotate 360° on its horizontal axis and 360° on its vertical axis to create 720° coverage of air circulation.

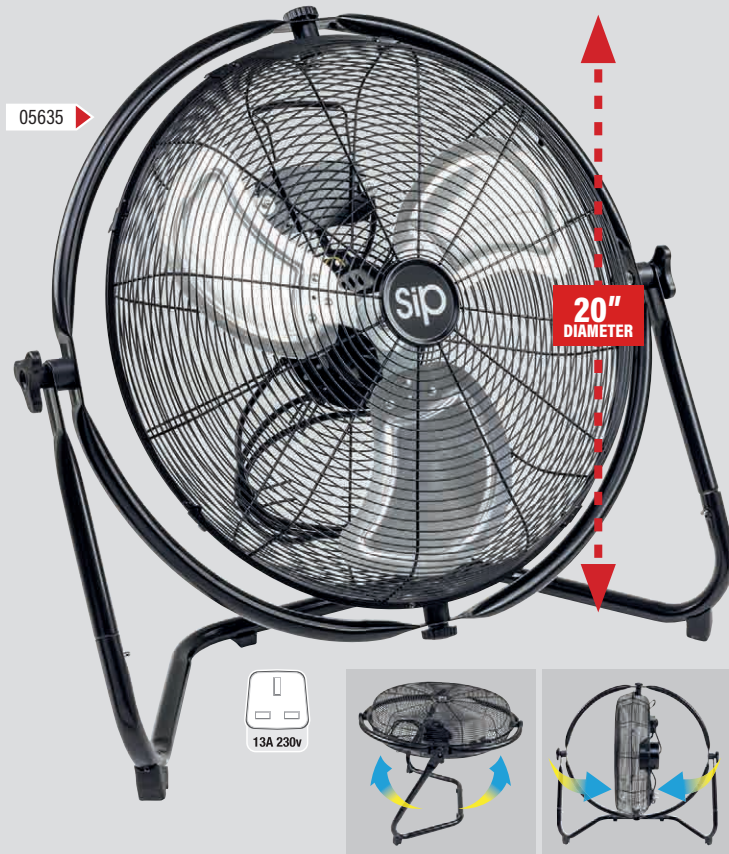

ROTATES 360° ON HORIZONTAL AND VERTICAL AXES FOR 720° ORBITAL AIR CIRCULATION COVERAGE

TO PLACE AN ORDER: ☎ 01509 500500

Item No	MODEL	INPUT SUPPLY	MOTOR	FAN DIAMETER	NO. OF SPEEDS	SPEED RANGE	NOISE LEVEL	EX. VAT	INC. VAT
05632	SIP 16" HEAVY-DUTY FLOOR FAN	230v (13A)	75w	406mm (16")	3	955 / 1111 / 1302rpm	60dB(A)	£49.99	£59.99
05633	SIP 18" HEAVY-DUTY OSCILLATING PEDESTAL FAN	230v (13A)	100w	457mm (18")	3	900 / 1100 / 1300rpm	66dB(A)	£99.99	£119.99
05613	SIP 20" HEAVY-DUTY FLOOR FAN	230v (13A)	111w	508mm (20")	3	850 / 1100 / 1350rpm	75dB(A)	£74.99	£89.99
05635	SIP 20" HEAVY-DUTY ORBITAL FLOOR FAN	230v (13A)	120w	508mm (20")	3	900 / 1100 / 1300rpm	68dB(A)	£89.99	£107.99

WHEEL-MOUNTED FANS

Fitted onto wheel-mounted cradled steel frames, our powerful heavy-duty drum fans offer outstanding mobility between locations for use. Our range includes higher motor power options making them ideal for industrial applications.

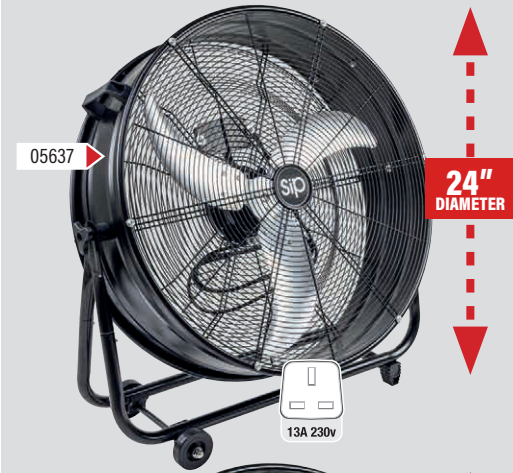

CRADLED STEEL FRAME WITH PULL HANDLES



VARIABLE THREE SPEED FAN SETTING



CRADLED STEEL FRAME WITH PULL HANDLES



VARIABLE TWO SPEED FAN SETTING



ADJUSTABLE TILTING DRUM ROTATES 360°

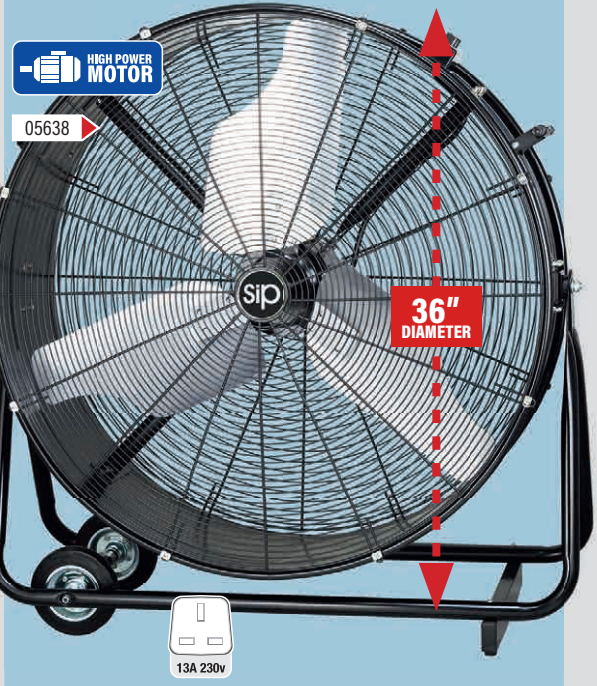
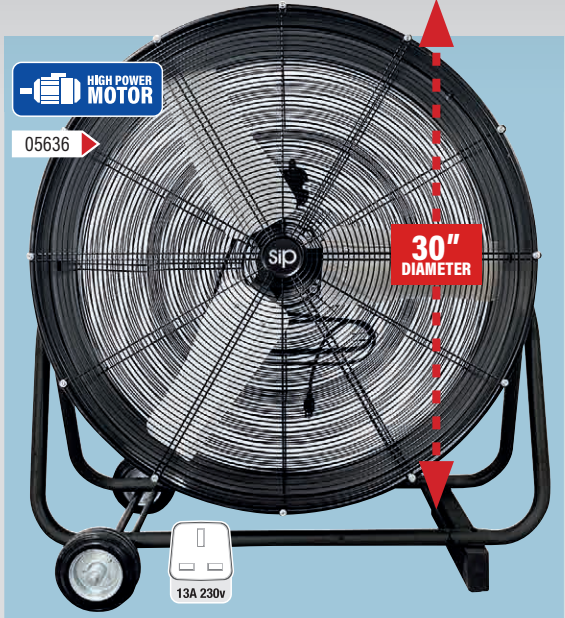

2MTR 110V POWER CABLE



VARIABLE TWO SPEED FAN SETTING



ADJUSTABLE TILTING DRUM ROTATES 360°

Item No	MODEL	INPUT SUPPLY	MOTOR	FAN DIAMETER	NO. OF SPEEDS	SPEED RANGE	NOISE LEVEL	EX. VAT	INC. VAT
05637	SIP 24" HEAVY-DUTY DRUM FAN	230v (13A)	120w	609mm (24")	3	900 / 1100 / 1300rpm	67dB(A)	£159.99	£191.99
05639	SIP 30" HEAVY-DUTY DRUM FAN	230v (13A)	123w	762mm (30")	2	850 / 950rpm	73dB(A)	£229.99	£275.99
05640	SIP 30" HEAVY-DUTY DRUM FAN - 110V	110v (16A)	120w	762mm (30")	2	850 / 950rpm	72dB(A)	£249.99	£299.99
05636	SIP 30" INDUSTRIAL DRUM FAN	230v (13A)	315w	762mm (30")	2	880 / 960rpm	84dB(A)	£299.99	£359.99
05638	SIP 36" INDUSTRIAL DRUM FAN	230v (13A)	410w	915mm (36")	2	860 / 950rpm	84dB(A)	£349.99	£419.99

SIP TEMPEST ELECTRIC PRESSURE WASHERS



BRUSHLESS INDUCTION MOTOR POWERED
FOR INCREASED DURABILITY

TOTAL STOP FUNCTION
ENERGY COST SAVING & REDUCED WEAR AND TEAR OF WATER PUMP

EXTRA-LARGE WHEELS
FOR EASIER MOVEMENT OVER UNEVEN TERRAIN

08972:
INDUSTRIAL STEEL LANCE WITH ADJUSTABLE NOZZLE
STEEL TURBO LANCE
8mtr HOSE
INTEGRATED 0.4ltr DETERGENT TANK

08974:
BRASS-HEADED AXIAL PLUNGER PUMP
INDUSTRIAL STEEL LANCE WITH ADJUSTABLE NOZZLE
STEEL TURBO LANCE
REINFORCED 8mtr HOSE
INTEGRATED 1.8ltr DETERGENT TANK



EXTRA LARGE WHEEL FOR EASIER MOVEMENT OVER UNEVEN TERRAIN

IDEAL FOR LIGHT COMMERCIAL USE

TO PLACE AN ORDER: 01509 500500

Item No	08970	08972	08974
MODEL	SIP CW2000	SIP CW2300	SIP CW2800
INPUT SUPPLY	230v (13A)	230v (13A)	230v (13A)
PUMP TYPE	SIP Axial	SIP Axial	Brass-Headed SIP Axial
MOTOR	2000w	2300w	2800w
TURBO PRESSURE	4000psi EWP* (Turbo Nozzle)	5700psi EWP* (Turbo Lance)	5100psi EWP* (Turbo Lance)
MAX. PRESSURE	2030psi (140bar)	2900psi (200bar)	2610psi (180bar)
WATER FLOW RATE	360ltr/hr	300ltr/hr	510ltr/hr
DETERGENT TANK	Clip-on foam / detergent bottle	0.4ltr	1.8ltr
EX. VAT	£129.99	£249.99	£349.99
INC. VAT	£155.99	£299.99	£419.99

*EWP (Equivalent Working Pressure) with turbo nozzle/lance action.



SIP PRO TEMPEST ELECTRIC PRESSURE WASHERS



BRUSHLESS INDUCTION MOTOR POWERED
FOR INCREASED DURABILITY

TOTAL STOP FUNCTION
ENERGY COST SAVING & REDUCED WEAR AND TEAR OF WATER PUMP

EXTRA-LARGE WHEELS
FOR EASIER MOVEMENT OVER UNEVEN TERRAIN

08909:
AXIAL 3 PISTON PUMP
CARRY HANDLE
QUICK WALL-COUPLING SYSTEM
HEAVY-DUTY 20mtr REINFORCED HOSE
ACCESSORIES WITH RACK



08976, 08978:
BRASS-HEADED TRIPLEX CRANKSHAFT PUMP; FOR DOUBLE THE LIFESPAN
HEAVY-DUTY 4-POLE SLOW-RUNNING MOTOR; FOR QUIETER OPERATION & LONGER LIFE
INDUSTRIAL STEEL LANCE WITH ADJUSTABLE NOZZLE
STAINLESS STEEL VALVES
ADJUSTABLE PRESSURE REGULATOR



IDEAL FOR LIGHT COMMERCIAL USE



IDEAL FOR COMMERCIAL USE

DETERGENT SUCTION

10m HEAVY-DUTY HOSE

Item No	08909	08976	08978
MODEL	SIP TEMPEST PW540/155 WALL-MOUNTED & PORTABLE PRESSURE ELECTRIC WASHER	SIP CW3000 PRO	SIP CW4000 PRO PLUS
INPUT SUPPLY	230v (13A)	230v (13A)	230v (13A)
PUMP TYPE	COMET brass-headed Axial plunger pump	SIP Crankshaft	SIP Crankshaft
MOTOR	2400w	2300w (4 POLE) 1450rpm	2800w (4 POLE) 1450rpm
MAX. PRESSURE	2320psi (160bar)	1740psi (120bar) VARIABLE	2175psi (150bar) VARIABLE
WATER FLOW RATE	510ltr/hr	up to 480ltr/hr	up to 540ltr/hr
DETERGENT	Clip-on foam / detergent bottle	Suction	1.8ltr Tank
EX. VAT	£669.99	£599.99	£699.99
INC. VAT	£803.99	£719.99	£839.99



08978 - INTEGRATED 1.8ltr DETERGENT TANK

SIP Professional Rotary Surface Cleaner

- Ideal for patios, walls and floors
- Complete with support handle
- Supplied with M22 fitting

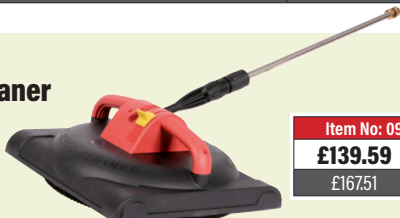

Item No: 09090
£139.59 EX.VAT
£167.51 INC.VAT

SIP Pressure Washer Detergent

- Heavy-duty concentrated detergent specially formulated for cleaning and removal of traffic film, heavy greasing, and stubborn ingrained soiling
- 5ltr

Item No: 02385
£14.19 EX.VAT
£17.03 INC.VAT



*EWP (Equivalent Working Pressure) with turbo nozzle/lance action.

TO PLACE AN ORDER: www.sip-group.com

ELECTRIC COLD WATER PRESSURE WASHERS

BRUSHLESS INDUCTION MOTOR POWERED
FOR INCREASED DURABILITY



EXTRA-LARGE WHEELS
FOR EASIER MOVEMENT OVER UNEVEN TERRAIN

08990:
CORROSION-RESISTANT BRASS-HEADED IN-LINE TRIPLEX CRANKSHAFT PUMP; FOR DOUBLE THE LIFESPAN
INTEGRATED 7.5LTR DETERGENT TANK



08961:
HEAVY-DUTY 3000W SLOW-RUNNING 4-POLE MOTOR; FOR QUIETER OPERATION & LONGER LIFE
PROTECTIVE METAL CASING
CORROSION-RESISTANT BRASS-HEADED IN-LINE TRIPLEX CRANKSHAFT PUMP; FOR DOUBLE THE LIFESPAN



08990

08961



IDEAL FOR COMMERCIAL USE

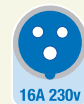

IDEAL FOR FARMING & HEAVY COMMERCIAL USE

TO PLACE AN ORDER: ☎ 01509 500500

Item No	08990	08961
MODEL	SIP TEMPEST P660/150	SIP TEMPEST HDP660/120-02
INPUT SUPPLY	230v (13A)	230v (16A)
PUMP TYPE	COMET brass-headed in-line Triplex crankshaft pump	COMET brass-headed in-line Triplex crankshaft pump
MOTOR	2900w (4hp), 4-POLE	3000w (4hp), 4-POLE
MAX. PRESSURE	2177psi (150bar)	1742psi (120bar)
WATER FLOW RATE	660ltr/hr	660ltr/hr
DETERGENT TANK	7.5ltr	-
EX. VAT	£899.99	£1199.99
INC. VAT	£1079.99	£1439.99

ELECTRIC HOT WATER PRESSURE WASHERS

BRUSHLESS INDUCTION MOTOR POWERED
FOR INCREASED DURABILITY

COMET
PUMP INCLUDED

TOTAL STOP FUNCTION
ENERGY COST SAVING & REDUCED WEAR AND TEAR OF WATER PUMP

EXTRA-LARGE WHEELS
FOR EASIER MOVEMENT OVER UNEVEN TERRAIN



08953:
EASY-TO-USE CONTROL PANEL



IDEAL FOR COMMERCIAL USE



08954:
EASY-TO-USE CONTROL PANEL



08954:
BRASS-HEADED AXIAL PLUNGER PUMP



08953



13A 230v



08954



13A 230v

BUILT-IN RETRACTABLE HOSE REEL

TWO COMPACT DESIGNS

Item No	08953	08954
MODEL	SIP TEMPEST PH480/150 HOT WATER	SIP TEMPEST PH540/150 HOT WATER
INPUT SUPPLY	230v (13A)	230v (13A)
PUMP TYPE	COMET brass-headed Axial plunger pump	COMET brass-headed Axial plunger pump
MOTOR	2100w (2.8hp), 2800rpm, 2-POLE	2700w (3.6hp), 2800rpm, 2-POLE
MAX. PRESSURE	2030psi (140bar)	2175psi (150bar)
WATER FLOW RATE	480ltr/hr	540ltr/hr
MAX. WATER TEMPERATURE	90°C	90°C
DETERGENT BOTTLE/TANK	350ml Bottle	4.5ltr Tank
BOILER FUEL TANK CAPACITY	4ltr (diesel)	15ltr (diesel)
ADDITIONAL FEATURES	ADJUSTABLE LOW PRESSURE DETERGENT SUCTION HEAVY-DUTY METAL LANCE WITH ADJUSTABLE NOZZLE 8 METRE HEAVY-DUTY HOSE WITH INTEGRATED HANGING HOOKS	ADJUSTABLE LOW PRESSURE DETERGENT SUCTION PRESSURE GAUGE HEAVY-DUTY METAL LANCE WITH ADJUSTABLE NOZZLE 8 METRE HEAVY-DUTY HOSE WITH BUILT-IN RETRACTABLE HOSE REEL
EX. VAT	£1299.99	£1499.99
INC. VAT	£1559.99	£1799.99

ELECTRIC HOT WATER PRESSURE WASHERS

BRUSHLESS INDUCTION MOTOR POWERED
FOR INCREASED DURABILITY

COMET
PUMP INCLUDED

TOTAL STOP FUNCTION
ENERGY COST SAVING & REDUCED WEAR AND TEAR OF WATER PUMP

EXTRA-LARGE WHEELS
FOR EASIER MOVEMENT OVER UNEVEN TERRAIN

IDEAL FOR COMMERCIAL USE



08941:
BRASS-HEADED AXIAL PLUNGER PUMP



08956:
BRASS-HEADED IN-LINE TRIPLEX CRANKSHAFT PUMP; DOUBLE THE LIFESPAN



EASY-TO-USE CONTROL PANEL



08956:
HEAVY-DUTY 4-POLE SLOW-RUNNING MOTOR; FOR QUIETER OPERATION & LONGER LIFE



EASY INTERNAL ACCESS



DETERGENT TANK



HOSE STORAGE HANGER



08956:
PISTOL GRIP WITH WATER PRESSURE REGULATOR AND SWIVEL CONNECTOR



RUBBER NOZZLE SHROUD LANCE PROTECTION

INTEGRATED FRONT & REAR BUMPERS
FOR PROTECTION & DURABILITY



13A 230v



TO PLACE AN ORDER: ☎ 01509 500500

Item No	08941	08956
MODEL	SIP TEMPEST PH600/140 A2 HOT WATER	SIP TEMPEST PH600/140 T4 HOT WATER
INPUT SUPPLY	230v (13A)	230v (13A)
PUMP TYPE	COMET brass-headed Axial plunger pump	COMET brass-headed in-line Triplex crankshaft pump
MOTOR	2200w (3hp), 2800rpm, 2-POLE	2200w (3hp), 1400rpm, 4-POLE
MAX. PRESSURE	2030psi (140bar)	2030psi (140bar)
WATER FLOW RATE	600ltr/hr	600ltr/hr
MAX. WATER TEMPERATURE	110°C	110°C
DETERGENT TANK	3.5ltr	3.5ltr
BOILER FUEL TANK CAPACITY	15ltr (diesel)	15ltr (diesel)
ADDITIONAL FEATURES	ADJUSTABLE LOW PRESSURE DETERGENT SUCTION PRESSURE GAUGE HEAVY-DUTY METAL LANCE WITH ADJUSTABLE NOZZLE 10 METRE HEAVY-DUTY HOSE	ADJUSTABLE LOW PRESSURE DETERGENT SUCTION PRESSURE GAUGE HEAVY-DUTY METAL LANCE WITH ADJUSTABLE NOZZLE 10 METRE HEAVY-DUTY HOSE
EX. VAT	£1999.99	£2199.99
INC. VAT	£2399.99	£2639.99

ELECTRIC HOT STEAM PRESSURE WASHERS

BRUSHLESS INDUCTION MOTOR POWERED
FOR INCREASED DURABILITY

COMET
PUMP INCLUDED

TOTAL STOP FUNCTION
ENERGY COST SAVING & REDUCED WEAR AND TEAR OF WATER PUMP

EXTRA-LARGE WHEELS
FOR EASIER MOVEMENT OVER UNEVEN TERRAIN



DETERGENT TANK WITH FLOW ADJUSTMENT TAP



EASY-TO-USE CONTROL PANEL



HEAVY-DUTY 4-POLE SLOW-RUNNING MOTOR; FOR QUIETER OPERATION & LONGER LIFE



RUBBER NOZZLE SHROUD LANCE PROTECTION

HIGH FLOW

MADE IN ITALY



BRASS-HEADED IN-LINE TRIPLEX CRANKSHAFT PUMP; FOR DOUBLE THE LIFESPAN

HOT STEAM

IDEAL FOR COMMERCIAL USE



INTEGRAL WATER SOFTENER / DESCALING TANK AS STANDARD



4 WHEELS; FOR ADDED STABILITY OVER UNEVEN TERRAIN

INTEGRATED FRONT BUMPER FOR PROTECTION & DURABILITY

Item No	08962	08964
MODEL	SIP TEMPEST PH660/120HDS HOT STEAM	SIP TEMPEST PH900/200HDS HOT STEAM
INPUT SUPPLY	230v (13A)	400v - 3Phase
PUMP TYPE	COMET brass-headed in-line Triplex crankshaft pump	COMET brass-headed in-line Triplex crankshaft pump
MOTOR	2200w (3hp), 4-POLE	5500w (7.5hp), 4-POLE
MAX. PRESSURE	1740psi (120bar) variable	2900psi (200bar) variable
WATER FLOW RATE	660ltr/hr variable	900ltr/hr variable
MAX. WATER TEMPERATURE	85 - 140°C	85 - 140°C
DETERGENT TANK	3.5ltr	3.5ltr
BOILER FUEL TANK CAPACITY	18ltr (diesel)	18ltr (diesel)
ADDITIONAL FEATURES	INTEGRAL WATER SOFTENER / DESCALING TANK LOW PRESSURE DETERGENT SUCTION PRESSURE GAUGE HEAVY-DUTY METAL LANCE WITH ADJUSTABLE NOZZLE 10 METRE HEAVY-DUTY HOSE	INTEGRAL WATER SOFTENER / DESCALING TANK LOW PRESSURE DETERGENT SUCTION PRESSURE GAUGE HEAVY-DUTY METAL LANCE WITH ADJUSTABLE NOZZLE 10 METRE HEAVY-DUTY HOSE
EX. VAT	£2999.99	£3199.99
INC. VAT	£3599.99	£3839.99

TO PLACE AN ORDER: www.sip-group.com

SUCKS WATER FROM BARRELS, TANKS & CONTAINERS... NO MAINS WATER SUPPLY NEEDED!

**PETROL POWERED
COLD WATER
PRESSURE WASHERS**

Robust in their design and versatile in their application, SIP's range of petrol powered cold water pressure washers support thorough cleaning, including locations where a mains water feed isn't accessible.

Built to deliver consistent high pressure, 2mtr suction head will suck water from alternative sources such as barrels, tanks and containers. The range includes solutions that are ideal for home and professional applications:

HOME USE



- Patios
- Driveways
- Decking
- Windows
- Conservatories
- Small vehicles

PROFESSIONAL USE



- Storage tanks & containers
- Gates, fences, railings
- Machine parts & components
- Hard outdoor surfaces
- Commercial vehicles

ADVANCED PROFESSIONAL USE



- Valeting
- Agriculture
- Engineering workshops
- Machine parts & components
- Hard outdoor surfaces
- Haulage vehicles

**PORTABLE &
LIGHTWEIGHT
ONLY 19KG**

08983 ▶



08984 ▶



08985 ▶



SIP AXIAL PUMP & INTEGRATED HOSE STORAGE BRACKET



SIP AXIAL PUMP

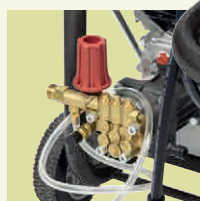

SIP AXIAL BRASS-HEADED VARIABLE PRESSURE PUMP

Item No	08983	08984	08985	08986
MODEL	SIP TEMPEST CW-P 145AX	SIP TEMPEST CW-P 160AX	SIP TEMPEST CW-P 215AX	SIP TEMPEST CW-P 225AX
PUMP TYPE	SIP Axial pump head	SIP Axial pump head	SIP Axial / Brass-headed	SIP Axial / Brass-headed
ENGINE	3.2hp EURO 5	6.5hp EURO 5	7hp EURO 5	7hp EURO 5
MAX. OUTPUT PRESSURE	2105psi (145bar)	2349psi (162bar)	3135psi (216bar) variable	3265psi (225bar) variable
WATER FLOW RATE	420ltr/hr	402ltr/hr	522ltr/hr variable	540ltr/hr variable
HOSE LENGTH	7.5mtr	7.5mtr	7.5mtr	7.5mtr
DETERGENT SUCTION	✓	✓	✓	Integrated tank - 1.5ltr
SUCKS WATER	2mtr suction head	2mtr suction head	2mtr suction head	2mtr suction head
USAGE				
EX. VAT	£279.99	£319.99	£399.99	£449.99
INC. VAT	£335.99	£383.99	£479.99	£539.99

Euro 5 Compliant Engines to meet emissions directive for non-road mobile machinery

TO PLACE AN ORDER: 01509 500500



ALL CW-RANGE PRESSURE WASHERS INCLUDE A SUCTION HOSE WITH FILTER/STRAINER HEAD



5x INTERCHANGEABLE SPRAY PATTERN NOZZLES INCLUDED
08984, 08985 & 08986

SIP Advanced Engine Oil

- A high-quality 10W-40 lubricant suitable for the needs of smaller 4-stroke engines
- 1ltr



Item No: 02419	
£6.99	EX VAT
£8.39	INC VAT

SIP Pressure Washer Detergent

- Heavy-duty concentrated detergent specially formulated for cleaning and removal of traffic film, heavy greasing, and stubborn ingrained soiling
- 5ltr



Item No: 02385	
£14.19	EX VAT
£17.03	INC VAT

SIP TEMPEST TP760/190 PETROL-POWERED PRESSURE WASHER

- Powerful 6.5hp (4.8kW) EURO 5 petrol engine for performance
- 2760psi (190bar) max. pressure and 750ltr/hr flow rate
- Large pneumatic tyres for easy movement over uneven terrain
- Low oil protection helps to prevent engine damage
- 10mtr heavy-duty rubber hose & heavy-duty lance

IDEAL FOR FARMING & CONTRACTOR USE



HEAVY-DUTY REINFORCED HOSE



BRASS-HEADED IN-LINE TRIPLEX CRANKSHAFT PUMP; DOUBLE THE LIFE-SPAN

PNEUMATIC TYRES; FOR EASIER MOVEMENT OVER UNEVEN TERRAIN

Item No: 08925	
£569.99	EX VAT
£683.99	INC VAT

08925 FEATURE:



5x INTERCHANGEABLE SPRAY PATTERN NOZZLES INCLUDED



SPACE-SAVING FOLDING FRAME DESIGN



08986

3265PSI HIGH PRESSURE



PNEUMATIC TYRES FOR EASIER MOVEMENT OVER UNEVEN TERRAIN

1.5ltr INTEGRATED DETERGENT TANK

SIP AXIAL BRASS-HEADED VARIABLE PRESSURE PUMP

SIP CLEANING

KOHLER® RANGE

SIP BRASS-HEADED AXIAL PLUNGER PUMP
SPACE-SAVING FOLDING FRAMES WITH EXTENDED HANDLES
HEAVY-DUTY REINFORCED HOSE
LARGE PNEUMATIC TYRES FOR EASIER MOVEMENT



08446 ▶



KOHLER
IN POWER. SINCE 1920.

3 YEAR
ENGINE WARRANTY

PREMIER QUALITY

IDEAL FOR
FARMING &
CONTRACTOR
USE

HONDA™ GP & GX RANGE

COMET AXIAL PLUNGER PUMP OR SIP BRASS-HEADED CRANKSHAFT PUMP OPTIONS
GEARBOX DRIVEN PUMP (ITEM: 08947)
SPACE-SAVING FOLDING FRAMES WITH EXTENDED HANDLES
HEAVY-DUTY REINFORCED HOSE
SWIVEL CONNECTION LANCE (ITEMS: 08948, 08950)
LARGE PNEUMATIC TYRES FOR EASIER MOVEMENT



08646 ▶



POWERED by
HONDA
2 year engine warranty

Honda™ GP Engines

POWERED by
HONDA
3 year engine warranty

Honda™ GX Engines Reliability, excellent build quality, compact design, low oil alert



IDEAL FOR
FARMING &
CONTRACTOR
USE



08947 ▶

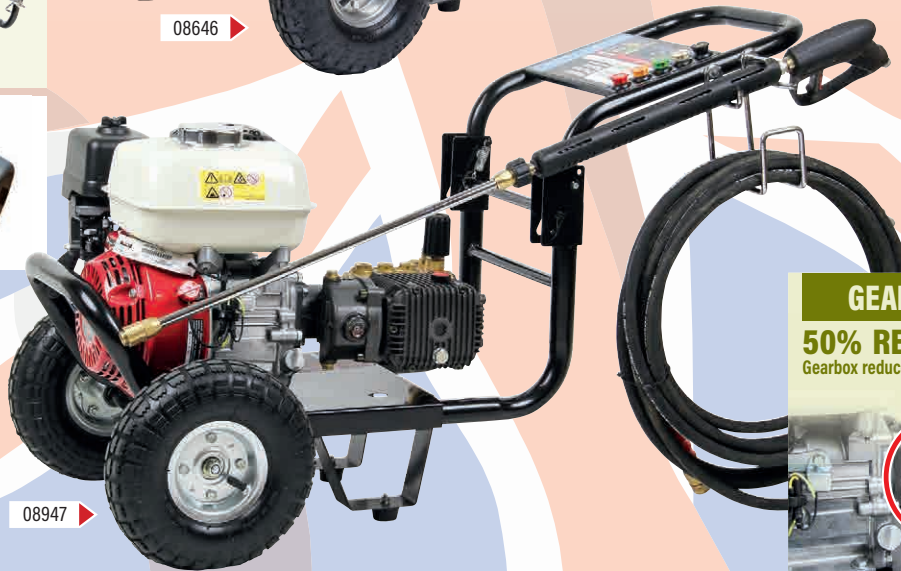

GEARBOX DRIVEN PUMP

50% REDUCED PUMP SPEED
Gearbox reduces the pump speed resulting in less wear and tear and prolonged life

TO PLACE AN ORDER: ☎ 01509 500500

Item No	MODEL	PUMP TYPE	ENGINE	MAX. OUTPUT PRESSURE	WATER FLOW RATE	HOSE LENGTH	SUCKS WATER*	LANCE TYPE	EX. VAT	INC. VAT
08442	SIP PP750/150WM	SIP Axial	7hp - 207CC (Kohler)	2175psi (150bar)	570ltr/hr	8mtr	-	Heavy-duty	£599.99	£719.99
08446	SIP PP660/165WM	SIP Axial	7hp - 207CC (Kohler)	2393psi (165bar)	660ltr/hr	10mtr	Up to 2mtr*	Heavy-duty	£749.99	£899.99
08642	SIP TPHGP570/150	COMET Axial	GP160 - 163CC (Honda)	2175psi (150bar)	570ltr/hr	8mtr	-	Heavy-duty	£649.99	£779.99
08646	SIP TPHGP660/165	COMET Axial	GP200 - 196CC (Honda)	2393psi (165bar)	660ltr/hr	8mtr	Up to 2mtr*	Heavy-duty	£799.99	£959.99
08643	SIP TPHGP760/190	SIP Crankshaft	GP200 - 196CC (Honda)	2760psi (190bar)	756ltr/hr	10mtr	-	Heavy-duty	£849.99	£1019.99
08946	SIP PP660/165	COMET Axial	GX160 - 163CC (Honda)	2393psi (165bar)	660ltr/hr	8mtr	Up to 2mtr*	Heavy-duty	£879.99	£1055.99
08943	SIP PP760/190	SIP Crankshaft	GX200 - 196CC (Honda)	2760psi (190bar)	756ltr/hr	10mtr	-	Heavy-duty	£899.99	£1079.99
08948	SIP PP960/210	COMET Crankshaft	GX340 - 340CC (Honda)	3045psi (210bar)	960ltr/hr	10mtr	Up to 2mtr*	Dual with end protector	£1499.99	£1799.99
08950	SIP PP960/280	COMET Crankshaft	GX390 - 389CC (Honda)	4005psi (276bar)	960ltr/hr	10mtr	Up to 2mtr*	Dual with end protector	£1599.99	£1919.99
08947	SIP PPG680/210	SIP Gearbox/Crankshaft	GX200 - 196CC (Honda)	3000psi (207bar)	676ltr/hr	9mtr	-	Heavy-duty + nozzles	£999.99	£1199.99

*Sucks Water (Low Pressure Priming Necessary)

Euro 5 Compliant Engines to meet emissions directive for non-road mobile machinery



SIP HONDA™ PETROL ENGINE COLD WATER PRESSURE WASHER

SIP PROFESSIONAL TEMPEST PPB480/160 BOWSER HONDA GX PETROL-POWERED PRESSURE WASHER

- Honda GX160 - 163CC petrol engine
- 2320psi (160bar) max. pressure
- 480ltr/hour water flow rate
- 120ltr panel unloader valve
- Regulated low pressure detergent suction
- Spray-gun with swivel connector

- Bent lance with adjustable rotating nozzle
- Fan-shaped nozzle
- Hose reel with 15mtr hose



POWERED by **HONDA**™
3 year engine warranty

Honda GX Engines
Reliability, excellent build quality, compact design, low oil alert



ALL-METAL BRASS-HEADED IN-LINE TRIPLEX CRANKSHAFT PUMP
120ltr WATER TANK
LARGE PUNCTURE-PROOF WHEELS



Item No: 08916
£1599.99 EX.VAT
£1919.99 INC.VAT

MADE IN ITALY

IDEAL FOR FARMING & CONTRACTOR USE

SUCKS WATER FROM BARRELS, TANKS & CONTAINERS... NO MAINS WATER SUPPLY NEEDED!

DIESEL POWERED COLD WATER PRESSURE WASHER

SIP TEMPEST CW-D 300TX DIESEL-POWERED PRESSURE WASHER

- 2mtr suction head; supplied with hose and filter strainer, ideal for sucking from a water butt, tank, barrel, or pond
- Powerhouse 9hp workhorse diesel engine built with an electric start and manual recoil
- Variable 4350psi (300bar) high pressure water jet and variable 900ltr/hr flow rate
- High-quality crankshaft pump; slow-running for increased life & added performance
- Adjustable pump pressure regulator ideal for variable pressure and flow
- Heavy-duty reinforced 15mtr high pressure hose
- Integrated detergent suction feature for enhanced cleaning performance
- 5 interchangeable spray nozzles ideal for a varied range of applications
- Heavy-duty tubular frame with vibration-reducing engine/chassis assembly for added stability
- 4 large puncture-proof wheels perfect for uneven and rough terrain



HIGH-QUALITY CRANKSHAFT PUMP; FOR DOUBLE THE LIFESPAN



SUPPLIED WITH SUCTION HOSE WITH FILTER/STRAINER HEAD



DIESEL POWERED



Item No: 08989
£1499.99 EX.VAT
£1799.99 INC.VAT

4x PNEUMATIC TYRES; FOR EASIER MOVEMENT OVER UNEVEN TERRAIN

ELECTRIC START

IDEAL FOR FARMING & CONTRACTOR USE

SIP VALETING MACHINES

Ideal for industrial carpet and upholstery cleaning

SIP 20 LITRE 1400 VALETING MACHINE

- 230v (13A) supply
- 1400w (1.8hp) motor
- Large 20ltr collection tank for minimal cleaning interruption
- 3ltr detergent tank for added cleaning power for stubborn dirt
- Easy switching between vacuum and detergent modes for versatility
- Mounted on 2 large wheels and 2 swivel castors for simple mobility
- 1.5mtr hose, detergent attachments, floor brush and crevice tool
- Quick rear drain plug for simple waste water removal



ACCESSORIES INCLUDED
2x lightweight metal tubes,
1x brush and 1x crevice tool



Item No: 07916
£149.99 EX.VAT
£179.99 INC.VAT



SIP MAINS ELECTRIC FLOOR SCRUBBER/DRYERS

SIP MAINS-POWERED WALK-BEHIND FLOOR SCRUBBER / DRYERS

Designed for commercial and industrial environments, these mains supply solutions combine powerful brush and vacuum motors alongside a large scrubbing and squeegee area for outstanding cleaning performance.



EASY-TO-USE CONTROLS



EASY ACCESS TO MECHANICAL PARTS



CLEAR & EASY-TO-USE CONTROL PANEL



EASY ACCESS TO MECHANICAL PARTS



FOLDING ARM
For convenient storage (07980 & 07982)

07980 ▶

07984 ▶



SQUEEGEES INCLUDED



Item No	MODEL	INPUT SUPPLY	WORKING CAPACITY	BRUSH MOTOR POWER	VACUUM MOTOR POWER	SCRUBBING AREA / SQUEEGEE WIDTH	BRUSH DIAMETER	CLEANING/SOLUTION TANK	BRUSH SPEED	WEIGHT	EX. VAT	INC. VAT
07980	SIP SDI260AC	230v (13A)	1260m ² /hr	370w (0.49hp)	400w (0.53hp)	360mm / 440mm	360mm	1ltr / 13ltr	130rpm	61kg	£1369.99	£1643.99
07984	SIP SDI600AC	230v (13A)	1600m ² /hr	400w (0.53hp)	700w (0.93hp)	450mm / 540mm	430mm	30ltr / 35ltr	150rpm	66kg	£1679.99	£2015.99

TO PLACE AN ORDER: ☎ 01509 500500



SIP VALETING MACHINES

SIP 1200/40 VALETING MACHINE

- 230v (13A) supply
- 1200w (1.6hp) 2-STAGE motor with bypass cooling
- Robust pump for 198mtr³ airflow and a 2200mm water lift height
- Large 40ltr stainless steel tank for minimal cleaning interruption
- 3ltr detergent tank for added cleaning power for stubborn dirt
- Mounted on 4 non-marking rubber castors for simple mobility
- Lightweight and compact design for added portability



ACCESSORIES INCLUDED
Upholstery cleaning head with 2mtr hose

SUPERIOR QUALITY 1200W 2-STAGE MOTOR WITH BYPASS COOLING FOR HIGHER SUCTION



Item No: 07928
£359.99 EX.VAT
£431.99 INC.VAT



SIP Floor Carpet Wand

- For use with 07928



Item No: 07981
£75.19 EX.VAT
£90.23 INC.VAT

SIP Valeting Detergent

- A heavy-duty concentrated, low foam cleaner specially formulated for cleaning and removal of soiling from carpets and upholstery
- Lightly perfumed, economical and rapid action in use
- 5ltr container



Item No: 02402
£19.69 EX.VAT
£23.63 INC.VAT

SIP BATTERY-POWERED FLOOR SCRUBBER/DRYERS

SIP RECHARGEABLE WALK-BEHIND FLOOR SCRUBBER / DRYERS

For added flexibility & convenience, our battery powered solutions offer the same powerful cleaning capacity without the restriction of a mains power cable. Supplied with a rechargeable 12v DC 55Ah battery to maintain intensive cleaning of stubborn dirt and grime.



CLEAR & EASY-TO-USE CONTROL PANEL



EASY ACCESS TO MECHANICAL PARTS



CLEAR & EASY-TO-USE CONTROL PANEL



EASY ACCESS TO BATTERY PACKS



◀ 07982



FOLDING ARM
For convenient storage



◀ 07986



SQUEEGEES INCLUDED



SIP Scrubber Detergent

- A low foaming, multi-functional alkaline cleaner which is suitable for use in most types of cleaning equipment. Particularly recommended for use in scrubber dryer equipment in factory storage areas and industrial warehousing etc.
- 10ltr container



Item No: 02401
£24.99 EX.VAT
£29.99 INC.VAT



ACCESSORIES AVAILABLE SEE WEBSITE FOR DETAILS

Item No	MODEL	INPUT SUPPLY	WORKING CAPACITY	BRUSH MOTOR POWER	VACUUM MOTOR POWER	SCRUBBING AREA / SQUEEGEE WIDTH	BRUSH DIAMETER	CLEANING/SOLUTION TANK	BRUSH SPEED	WEIGHT	EX. VAT	INC. VAT
07982	SIP SD1260BAT	12v DC (1x 55Ah)	1260m ² /hr	250w (0.33hp)	180w (0.24hp)	360mm / 440mm	360mm	11ltr / 13ltr	130rpm	70kg	£1899.99	£2279.99
07986	SIP SD1600BAT	12v DC (2x 55Ah)	1600m ² /hr	400w (0.53hp)	400w (0.53hp)	450mm / 540mm	430mm	30ltr / 35ltr	150rpm	97kg	£2399.99	£2879.99

TO PLACE AN ORDER: www.sip-group.com

ELECTRIC SUBMERSIBLE WATER PUMPS



FOR DELIVERY HOSES
SEE PAGE 25

Ideal for draining flooded areas quickly, submersible water pumps help to prevent costly damage to property or work areas and are suitable in garden maintenance, agricultural and construction applications.



13A 230v



SIP SUB 3040-FS WATER PUMP

- 230v (13A) input supply
- 400w (0.5p) motor
- 6mtr max. pump head
- 9,000ltr/hr flow rate
- 5mm particle diameter
- 7mtr operating depth
- 25 - 40mm Ø / 1" BSP outlet diameter
- Float switch prevents the pump from running dry
- 9mtr power cable

YouTube



SCAN HERE

SIP SUB 3075-FS DIRTY WATER PUMP

- 230v (13A) input supply
- 750w (1hp) motor
- 8mtr max. pump head
- 14,100ltr/hr flow rate
- 35mm particle diameter
- 7mtr operating depth
- 25 - 40mm Ø / 1" BSP outlet diameter
- Float switch prevents the pump from running dry
- 10mtr power cable

YouTube



SCAN HERE

SIP 3/4" WATER BUTT PUMP

- Designed specifically for extracting water from butts
- 230v (13A) input supply
- 300w (1hp) motor
- 11mtr max. pump head
- 2,200ltr/hr flow rate
- Ideal for garden applications with a sturdy and long aluminium swan neck for all popular butt sizes
- Supplied with a quick fit connector and tap
- Fitted with a float switch to turn off the pump when the water level is low
- 10mtr power cable

Item No: 06865
£49.99 EX.VAT
£59.99 INC.VAT

FLOAT SWITCH;
AUTO CUT
ON/OFF

Item No: 06888
£69.99 EX.VAT
£83.99 INC.VAT

FLOAT SWITCH;
AUTO CUT
ON/OFF

SUITABLE FOR
DIRTY WATER

Item No: 06908
£59.99 EX.VAT
£65.99 INC.VAT

FLOAT SWITCH;
AUTO CUT
ON/OFF



9mtr
PUMPING HEAD

35MM
PARTICLE Ø

STAINLESS STEEL
BODY FOR GREATER
DURABILITY



8mtr
PUMPING HEAD

35MM
PARTICLE Ø

STAINLESS STEEL
CASE & BASE
FOR GREATER
DURABILITY

SIP SUB 3010-SS HEAVY-DUTY DIRTY WATER PUMP

- 230v (13A) input supply
- 1000w (1.3hp) motor
- 9mtr max. pump head
- 18,000ltr/hr flow rate
- 35mm particle diameter
- 7mtr operating depth
- Stainless steel body
- 25 - 40mm Ø / 1" BSP outlet diameter
- Float switch prevents the pump from running dry
- 10mtr power cable

SIP SUB 3075-SS HEAVY-DUTY DIRTY WATER PUMP

- 230v (13A) input supply
- 750w (1hp) motor
- 8mtr max. pump head
- 16,500ltr/hr flow rate
- 35mm particle diameter
- 7mtr operating depth
- 25 - 40mm Ø / 1" BSP outlet diameter
- Stainless steel casing & base
- Float switch prevents the pump from running dry
- 10mtr power cable

Item No: 06897
£99.99 EXVAT
£119.99 INCVAT

FLOAT SWITCH;
AUTO CUT
ON/OFF

SUITABLE FOR
DIRTY WATER



Item No: 06825
£129.99 EXVAT
£155.99 INCVAT

FLOAT SWITCH;
AUTO CUT
ON/OFF

SUITABLE FOR
DIRTY WATER



ELECTRIC SURFACE-MOUNTED WATER PUMPS



SIP EP2M ELECTRIC SURFACE WATER PUMP

- 230v (13A) input supply
- Powerful 550w (0.7hp) motor
- 8mtr max. suction head
- 40mtr max. pumping head
- 40ltr/min max. water flow rate
- Heavy-duty cast iron housing
- Brass impeller with easy access
- Thermal overload protection
- 1" suction outlet diameter
- 2x couplers included
- Ideal for general pumping and draining



TOUGH CAST IRON HOUSING & BRASS IMPELLER



13A 230v

40 METRE MAX. PUMPING HEAD

Item No: 07614

£69.99 EX.VAT
£83.99 INC.VAT

SIP 1" STAINLESS STEEL SELF-PRIMING SURFACE-MOUNTED WATER PUMP

- 230v (13A) input supply
- Powerful 1200w motor
- 8mtr max. suction head
- 50mtr max. pumping head
- 4800ltr/hr max. water flow rate
- 1" outlet / inlet diameter
- 35°C max. water temperature
- Hand-portable and lightweight design; just 9kg
- Heavy-duty corrosion-resistant stainless steel pump
- Pump driven by a powerful 1200w motor
- Versatile pump perfect for a variety of domestic and professional applications



LIGHTWEIGHT & PORTABLE



13A 230v

50 METRE MAX. PUMPING HEAD

Item No: 06906

£129.99 EX.VAT
£155.99 INC.VAT

SIP 1" STAINLESS STEEL SURFACE-MOUNTED BOOSTER WATER PUMP

- Pump designed for boosting and maintaining water pressure
- Suitable for fixed installation from mains water supply or from ponds, and external supplies for garden and agricultural applications
- 230v (13A) input supply
- Powerful 1000w motor
- 8mtr max. suction head
- 45mtr max. pumping head
- 4500ltr/hr max. water flow rate
- Water pressure is maintained using a fitted pressure switch; controlled between 1.4 - 2.8bar (20 - 40.6psi)
- 1" outlet / inlet diameter
- 35°C max. water temperature
- Heavy-duty corrosion-resistant stainless steel
- Heavy-duty braided pump connector hose
- Pump motor switches on/off depending on demand
- 20ltr tank



06907

OPTIONAL Inlet filter & NRV Foot Valve available see table below

Item No: 06907

£179.99 EX.VAT
£215.99 INC.VAT



13A 230v

45 METRE MAX. PUMPING HEAD

Item No	TYPE	EX. VAT	INC. VAT
PW11-00600	Inlet Filter for 06907	£19.99	£23.99
PW11-00601	NRV Foot Valve for 06907	£4.99	£5.99

20 LITRE TANK



ITEM NO: 06909

SIP 1" STAINLESS STEEL BOOSTER WATER PUMP WITH INLET FILTER & NRV FOOT VALVE

Item No: 06909

£199.99 EX.VAT
£239.99 INC.VAT





PETROL & DIESEL POWERED WATER PUMPS



TOUGH CAST IRON IMPELLER AND VOLUTE HOUSING
LOW OIL SHUT DOWN
 (04913, 03933, 04919)

YouTube



SCAN HERE



YouTube



SCAN HERE

HOSE END STRAINERS INCLUDED

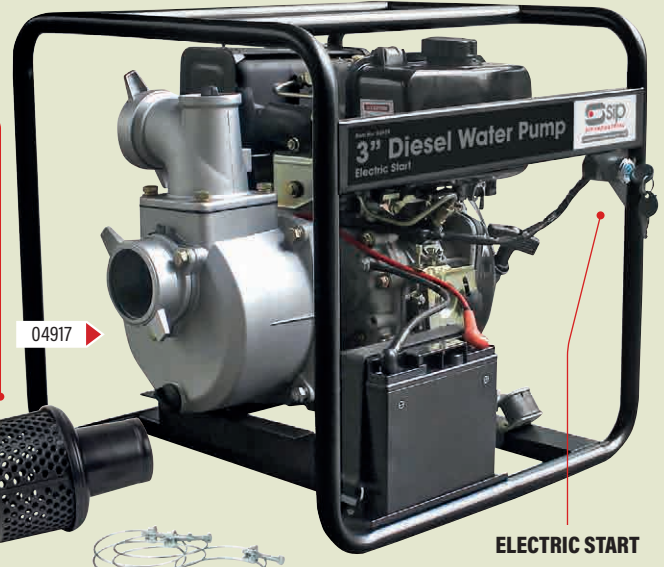

Item No	MODEL	MOTOR / ENGINE	MAX. PUMPING HEAD	WATER FLOW RATE	MAX. SUCTION HEAD	OUTLET DIAMETER	EX. VAT	INC. VAT
04913	SIP 1" PETROL WATER PUMP	SIP 2.6hp	30mtr	116ltr/min (7m ³ /hr)	7mtr	25mm (1")	£159.99	£191.99
03933	SIP 2" PETROL WATER PUMP	SIP 7hp	30mtr	550ltr/min (33m ³ /hr)	7mtr	50mm (2")	£189.99	£227.99
04919	SIP 3" PETROL WATER PUMP	SIP 7hp	28mtr	1000ltr/min (60m ³ /hr)	7mtr	80mm (3")	£199.99	£239.99
04917	SIP 3" DIESEL WATER PUMP (ELECTRIC START)	SIP 8.7hp	26mtr	1000ltr/min (60m ³ /hr)	6mtr	80mm (3")	£799.99	£959.99

Euro 5 Compliant Engines to meet emissions directive for non-road mobile machinery

SIP SUCTION & LAYFLAT DELIVERY HOSES



07623

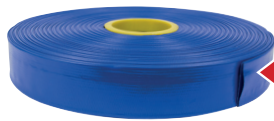

07622

Item No	DIAMETER	BEND RADIUS	TYPE	LENGTH	EX. VAT	INC. VAT
07602	1"W	105mm	Suction	10mtr	£27.29	£32.75
07623	2"	205mm	Suction	10mtr	£78.49	£94.19
07321	3"	320mm	Suction	10mtr	£119.89	£143.87

Item No	DIAMETER	TYPE	LENGTH	EX. VAT	INC. VAT
07671	1"	Layflat - Delivery	10mtr	£23.99	£28.79
07615	1¼"	Layflat - Delivery	10mtr	£29.49	£35.39
07630	1½"	Layflat - Delivery	10mtr	£32.69	£39.23
07631	1½"	Layflat - Delivery	100mtr	£131.89	£158.27
07621	2"	Layflat - Delivery	10mtr	£35.99	£43.19
07622	2"	Layflat - Delivery	100mtr	£155.89	£187.07
07692	3"	Layflat - Delivery	10mtr	£42.49	£50.99

NEW RANGE

PETROL POWERED

SIP PETROL-POWERED INVERTER GENERATORS

Reasons to Choose an SIP Inverter Generator

Outstanding Functionality

Smart power solution, perfect for outdoor and leisure applications. Powers devices such as smartphones, laptops, portable lighting and small appliances.

Clean, Safe & Stable Supply

4th generation digital inverter technology with pure sine wave output ensures a reliable supply.

Thermally protected inverter module for added user safety.

Greater Fuel Economy

Fitted with an integrated economy control switch for low loads.

Helps to reduce fuel consumption for greater efficiency.

Quiet, Compact and Portable

Considerably quieter than traditional power generators.

Compact design with great portability and mobility.



ACCESSORY KIT INCLUDED



DIGITAL INVERTER TECHNOLOGY!

RUN LAPTOPS, MOBILES & OTHER ELECTRONIC DEVICES



LOW NOISE



LOW NOISE



INTEGRATED WHEELS AND HANDLE

TO PLACE AN ORDER: 01509 500500

Item No	25400	25401	25402
MODEL	SIP ISG1101 DIGITAL INVERTER GENERATOR	SIP ISG2202 DIGITAL INVERTER GENERATOR	SIP ISG3303 DIGITAL INVERTER GENERATOR
OUTPUT SUPPLY	1x 230v AC & 1x 12v DC	2x 230v AC & 1x 12v DC	2x 230v AC & 1x 12v DC
MAXIMUM PEAK OUTPUT	1100w	2000w	3000w
CONTINUOUSLY RATED OUTPUT	1000w	1800w	2700w
USB OUTPUT	2x 5v 2A	2x 5v 2A	2x 5v 2A
ENGINE	60cc	78.5cc	149cc
FUEL TYPE	Unleaded Petrol	Unleaded Petrol	Unleaded Petrol
FUEL TANK CAPACITY	2.4ltr	4ltr	6ltr
MAX. RUN TIME	6hrs	8hrs	10hrs
NOISE LEVEL* (at 7 metres running at 1/4 load)	55dB	58dB	68dB
WEIGHT	13.75kg	20kg	28kg
EX. VAT	£299.99	£549.99	£769.99
INC. VAT	£359.99	£659.99	£923.99

*LWA Noise Directive 2000/14EC figures: 25400 = 95dB(A), 25401 = 95dB(A), 25402 = 96dB(A)

Euro 5 Compliant Engines to meet emissions directive for non-road mobile machinery



SIP PETROL-POWERED GENERATORS

SIP MEDUSA T952 COMPACT GENERATOR

- Up to 750w peak output, 650w continuously rated
- 60cc, 2hp, 2 stroke petrol engine EURO V
- 1x 230v (13A) AC socket & 1x 12v DC battery charging (up to 40Ah batteries)
- 4ltr fuel tank capacity
- Up to 6.5hrs running time
- Capable of powering small power tools, and work lights etc.

720W PEAK OUTPUT

UP TO 6.5hrs RUNTIME

VOLT METER

OUTPUT SOCKETS:
1X 230V, 13A (AC)
1X 12V (DC)



Item No: 03920

£149.99 EXVAT
£179.99 INCVAT



SIP MEDUSA T2500W GENERATOR

- Up to 2200w peak output, 2000w continuously rated
- 212cc, 4 stroke, air-cooled, OHV petrol engine EURO V
- 2x 230v (13A) AC sockets & 1x 12v DC battery charging (up to 40Ah batteries)
- Automatic Voltage Regulator (AVR)
- 15ltr fuel tank capacity
- Up to 10hrs running time
- Low oil pressure alert system

2200W PEAK OUTPUT

UP TO 10hrs RUNTIME

LONG RANGE FUEL TANK

OUTPUT SOCKETS:
2X 230V, 13A (AC)
1X 12V (DC)

A.V.R.
(AUTO VOLTAGE REGULATION)
STABLE OUTPUT FOR SENSITIVE
EQUIPMENT



Item No: 25124

£249.99 EXVAT
£299.99 INCVAT

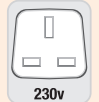

SIP MEDUSA T3000W GENERATOR

- Up to 3000w peak output, 2700w continuously rated
- 212cc, 4 stroke, air-cooled, OHV petrol engine EURO V
- 1x 230v (16A) AC, 1x 110v (16A) AC sockets & 1x 12v DC battery charging (up to 40Ah batteries)
- Automatic Voltage Regulator (AVR)
- 15ltr fuel tank capacity
- Up to 8hrs running time
- Low oil pressure alert system

3000W PEAK OUTPUT

UP TO 8hrs RUNTIME

LONG RANGE FUEL TANK

OUTPUT SOCKETS:
1X 230V, 16A (AC)
1X 110V, 16A (AC)
1X 12V (DC)

A.V.R.
(AUTO VOLTAGE REGULATION)
STABLE OUTPUT FOR SENSITIVE
EQUIPMENT



Item No: 25133

£299.99 EXVAT
£359.99 INCVAT



SIP MEDUSA T5500W GENERATOR

- Up to 5500w peak output, 5000w continuously rated
- 390cc (13hp), 4-stroke, air-cooled, OHV petrol engine EURO V
- 1x 230v (32A), 1x 110v (32A) AC sockets & 1x 12v DC battery charging (up to 8.3A)
- Includes AVR (Automatic Voltage Regulator)
- 25ltr fuel tank • Up to 8hrs running time
- Low oil pressure alert system
- Wheel-mounted, full frame design with integrated handles
- Electric start (battery included)

ELECTRIC START

5500W PEAK OUTPUT

UP TO 8hrs RUNTIME

LONG RANGE FUEL TANK

OUTPUT SOCKETS:
1X 230V, 32A (AC)
1X 110V, 32A (AC)
1X 12V (DC)

A.V.R.
(AUTO VOLTAGE REGULATION)
STABLE OUTPUT FOR SENSITIVE
EQUIPMENT



Item No: 25137

£649.99 EXVAT
£779.99 INCVAT



SIP 13A/16A Socket Adaptor (230v)

- Suitable for 13A and 16A sockets
- Durable heavy-duty plastic casing
- Manufactured for long life



Item No: 04592

£29.99 EXVAT
£35.99 INCVAT

SIP 16A Socket Plug (230v)

- Suitable for 16A sockets
- Durable heavy-duty plastic casing
- Manufactured for long life



Item No: 04595

£4.99 EXVAT
£5.99 INCVAT

Euro 5 Compliant Engines to meet emissions directive for non-road mobile machinery

TO PLACE AN ORDER: www.sip-group.com

SIP PROFESSIONAL KOHLER® ENGINE PETROL-POWERED GENERATORS



Our range of KOHLER® engine petrol generators boast fantastic power output and 3 year manufacturer engine warranty. These generators are robust and reliable comprising of a **HEAVY-DUTY MAINTENANCE-FREE ALTERNATOR, CAST IRON CYLINDER AND RUGGED FRAME.**

- Quad Clean™ heavy-duty cyclonic air cleaner which forces large particles of contaminants out of the engine
- Engineered for enhanced durability - Oversized mufflers, steel-forged crankshafts and oversized ignition systems
- Engine designed in the USA - Electric start option available (see below for details)

IDEAL FOR HEAVY-DUTY COMMERCIAL USE

DON'T FORGET...
SIP 1 Litre Advanced Engine Oil



Item No: 02419
£6.99 EX.VAT
£8.39 INC.VAT



KOHLER
IN POWER. SINCE 1920.

3 YEAR ENGINE WARRANTY

PREMIER QUALITY

LONG RANGE FUEL TANK OPTION

DUAL VOLTAGE 110V / 230V OUTPUT



ASSEMBLED & TESTED BY SIP IN THE UK



Item No	MODEL	OUTPUT SUPPLY SOCKETS	MAX. PEAK OUTPUT	CONT. RATED MAX. OUTPUT	ENGINE	FUEL TANK SIZE	RUN TIME	FRAME TYPE	EX. VAT	INC. VAT
04340	SIP MEDUSA MGKP3.5FF	1x 110v (16A) 1x 230v (16A)	3.75kVA	3.5kVA	KOHLER® 7HP 207CC	4.1ltr	3hrs	Full Frame	£619.99	£743.99
04355	SIP MEDUSA MGKP7FF	1x 110v (16A) / 1x 230v (16A) 1x 110v (32A) / 1x 230v (32A)	75kVA	7kVA	KOHLER® 14HP 429CC	7.5ltr	2.8hrs	Full Frame	£1249.99	£1499.99
04357	SIP MEDUSA MGKP7FE	1x 110v (16A) / 1x 230v (16A) 1x 110v (32A) / 1x 230v (32A)	75kVA	7kVA	KOHLER® 14HP 429CC	25ltr Long Range	8.5hrs	ELECTRIC START	£1499.99	£1799.99

Item No	KOHLER PETROL ENGINE MAINTENANCE SERVICE KITS	EX. VAT	INC. VAT
04480A	SERVICE KIT for CH270 - 7HP	£44.69	£53.63
04482A	SERVICE KIT for CH395 - 7HP and CH440 - 14HP	£47.99	£57.59

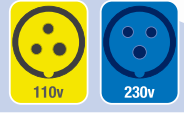

SIP PROFESSIONAL HONDA™ ENGINE PETROL-POWERED GENERATORS

Our popular HONDA™ engines are powerful, reliable and are covered by a 3 year manufacturer engine warranty. These generators are robust comprising of a **HEAVY-DUTY MAINTENANCE-FREE ALTERNATOR, CAST IRON CYLINDER AND RUGGED FRAME.**

- Splash-fed oil lubrication system - Low oil shutdown prevents engine damage
- Cast iron cylinder liner - Hot spark electronic ignition available (see below for details)

POWERED by HONDA™
3 year engine warranty

Honda™ GX Engines
Reliability, excellent build quality, compact design, low oil alert

LONG RANGE FUEL TANK OPTION

DUAL VOLTAGE 110V / 230V OUTPUT



ASSEMBLED & TESTED BY SIP IN THE UK



IDEAL FOR HEAVY-DUTY COMMERCIAL USE

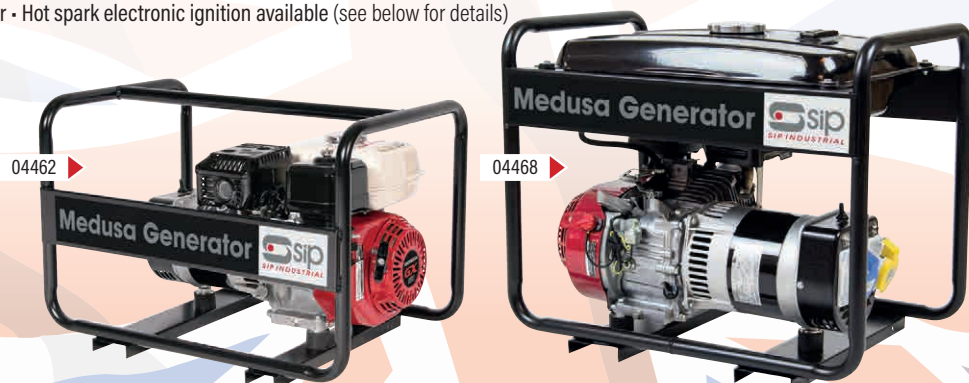

Item No	MODEL	OUTPUT SUPPLY SOCKETS	MAX. PEAK OUTPUT	CONT. RATED MAX. OUTPUT	ENGINE	FUEL TANK SIZE	RUN TIME	FRAME TYPE	EX. VAT	INC. VAT
04462	SIP MEDUSA MGHP3.5FF	1x 110v (16A) 1x 230v (16A)	3.75kVA	3.5kVA	HONDA™ GX200 196CC	3.6ltr	2.6hrs	Full Frame	£719.99	£863.99
04468	SIP MEDUSA MGHP3.5FLR	1x 110v (16A) 1x 230v (16A)	3.75kVA	3.5kVA	HONDA™ GX200 196CC	15ltr Long Range	9hrs	Full Frame	£749.99	£899.99
04476	SIP MEDUSA MGHP6.0FLR	1x 110v (16A) / 1x 230v (16A) 1x 110v (32A) / 1x 230v (32A)	72kVA	6kVA	HONDA™ GX390 389CC	25ltr Long Range	8.5hrs	Full Frame	£1599.99	£1919.99
04478	SIP MEDUSA MGHP6.0FLER	1x 110v (16A) / 1x 230v (16A) 1x 110v (32A) / 1x 230v (32A)	72kVA	6kVA	HONDA™ GX390 389CC	25ltr Long Range	8.5hrs	ELECTRIC START	£1799.99	£2159.99

Item No	HONDA ENGINE MAINTENANCE SERVICE KITS	EX. VAT	INC. VAT
14552	AIR FILTER for HONDA™ GX160 / GX200 / GP200	£32.99	£39.59
14553	AIR FILTER for HONDA™ GX240 / GX270 / GP270	£31.59	£37.91
14564	AIR FILTER for HONDA™ GX340 / GX390 / GP390	£44.99	£53.99
14594	SPARK PLUG for HONDA™ GP and GX Engines	£7.69	£9.23

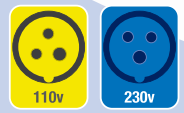

Euro 5 Compliant Engines to meet emissions directive for non-road mobile machinery

TO PLACE AN ORDER: 01509 500500



SIP SILENCED DIESEL-POWERED GENERATORS

SIP MEDUSA T5500 SILENCED DIESEL GENERATOR

This mobile power supply solution is suitable for workshops, general construction and mobile hospitality. Other uses include powering machinery, tools and lighting.

Enclosed in a heavy-duty silenced metal cabinet, it delivers an overall runtime of 15hrs at 50% load from a 16ltr fuel tank.

- Output: Peak 5.5kVA/5.5kW - Continuous 5kVA/5kW (1000 hour intermittent use)

- Current (A): 230v 5kW 24A / 115v 3.5kW 30A (1000 hour intermittent use)
- 110v and 230v supply with AVR (Automatic Voltage Regulator)
- Heavy-duty silenced generator cabinet
- Digital display indicates volts and running time
- Fitted with large wheels for rough terrain surfaces

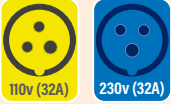

ELECTRIC START

5.5kW PEAK OUTPUT

UP TO 7.5hrs RUNTIME

16LTR FUEL TANK

OUTPUT SOCKETS:
1X 110V, 32A (AC)
1X 230V, 32A (AC)
1X 12V (DC)

A.V.R.
AUTO VOLTAGE
REGULATION
STABLE OUTPUT
FOR SENSITIVE
EQUIPMENT



IDEAL AS A
MOBILE POWER SUPPLY

2 years or 1000 working hours warranty valid on intermittent use only

SIP MEDUSA T14000 SILENCED DIESEL GENERATOR

Offering greater power output and an Automatic Transfer Switch, this silenced generator provides additional functionality for stand-by applications.

Ensuring supply continues running when power is interrupted, it provides runtime of 18hrs at 50% load from a 35ltr fuel tank.

- Output: Peak 13.7kVA/11kW. Continuous 12.5kVA/10kW (1000 hour intermittent use)
- Current (A): 230v 3.2kW 13.9A / 400v 10kW 18A

- 230v & x2 400v supply with AVR (Automatic Voltage Regulator)
- Heavy-duty silenced generator cabinet
- Digital display indicates volts and running time
- Automatic transfer switch
- Fitted with castor wheels for indoor mobility



ELECTRIC START

11kW PEAK OUTPUT

UP TO 9hrs RUNTIME

35LTR FUEL TANK

OUTPUT SOCKETS:
1X 230V, 32A (AC)
2X 400V, 32A (AC)

A.V.R.
AUTO VOLTAGE
REGULATION
STABLE OUTPUT
FOR SENSITIVE
EQUIPMENT



SUPPLIED WITH ATS BOX
FOR UNINTERRUPTED
POWER SUPPLY



IDEAL FOR
STAND-BY APPLICATIONS

2 years or 1000 working hours warranty valid on intermittent use only

Item No	MODEL	OUTPUT SUPPLY SOCKETS	MAX. PEAK OUTPUT	CONT. RATED MAX. OUTPUT	ENGINE	FUEL TANK SIZE	RUN TIME	SOUND POWER (LwA)	EX. VAT	INC. VAT
25153	SIP MEDUSA T5500 SILENCED DIESEL GENERATOR	1x 110v 1x 230v	5.5kVA / 5.5kW	5kVA / 5kW	0.5ltr EURO V Single Cylinder	16ltr	7.5hrs	97dB(A)	£1499.99	£1799.99
25151	SIP MEDUSA T14000 SILENCED DIESEL GENERATOR	1x 230v 2x 400v	13.7kVA / 11kW	12.5kVA / 10kW	0.9ltr EURO V Single Cylinder	35ltr	9hrs	112dB(A)	£3999.99	£4799.99

Euro 5 Compliant Engines to meet emissions directive for non-road mobile machinery

TO PLACE AN ORDER: www.sip-group.com

IMPROVED RANGE

SIP PROFESSIONAL PILLAR DRILLS

Ideal for preparing and finishing a variety of work piece materials including ferrous and non-ferrous metals, soft and hard woods and high-density plastics.

- STURDY CAST IRON BASES FOR ADDED STABILITY
- HEAVY-DUTY INDUCTION MOTORS; EXCELLENT PERFORMANCE FOR DEMANDING ENVIRONMENTS
- SAFETY CHUCK GUARDS INCLUDED
- ONE PIECE CAST STEEL SOFT-GRIP HANDLE (NOT ITEMS: 01710 & 01711)



**NEW
HIGH
POWER
MOTORS**

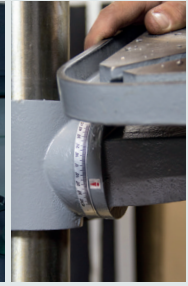

ONE PIECE CAST STEEL SOFT-GRIP HANDLES (NOT ITEM: 01710, 01711)

FULLY ADJUSTABLE TABLE; VERSATILE DRILL POSITIONING WITH TABLE TILT SCALE

NVR SWITCH: ADDITIONAL SAFETY, PREVENTS ACCIDENTAL START-UP AFTER POWER INTERRUPTIONS (NOT ITEM: 01710)

BENCH-STANDING OPTIONS

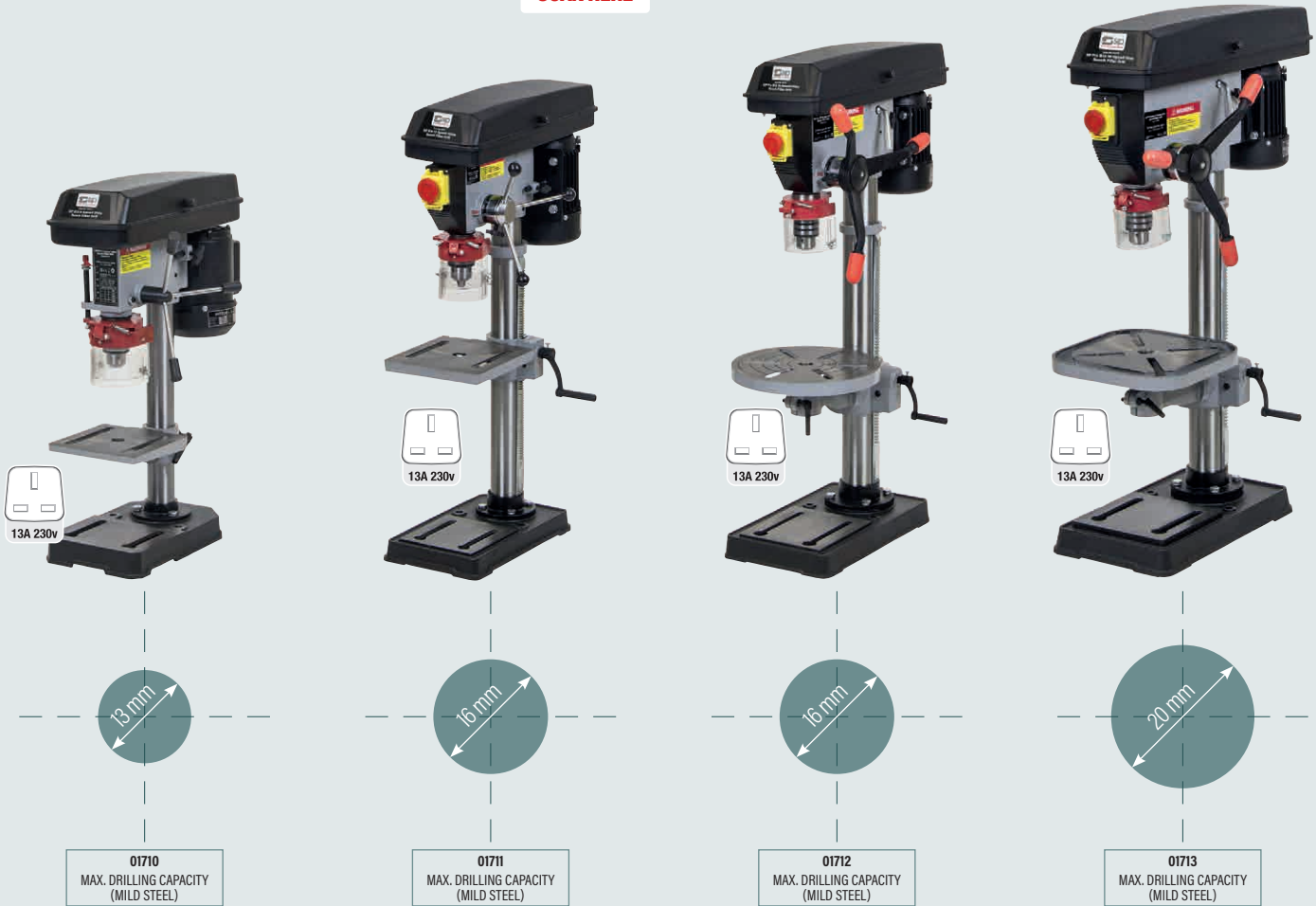

TO PLACE AN ORDER: ☎ 01509 500500

Item No	01710	01711	01712	01713	01714	01715	01716	01717	01718
MODEL	SIP B13 5-SPEED 350w	SIP B16 12-SPEED 450w	SIP B16 16-SPEED 550w	SIP B20 16-SPEED 750w	SIP F16 16-SPEED 550w	SIP F20 16-SPEED 750w	SIP F20 12-SPEED 750w	SIP F20 12-SPEED 1100w	SIP F20 12-SPEED 1100w 400v
TYPE	Bench	Bench	Bench	Bench	Floor	Floor	Floor	Floor	Floor
INPUT SUPPLY	230v (13A)	230v (13A)	230v (13A)	230v (13A)	230v (13A)	230v (13A)	230v (13A)	230v (13A)	400v (3 phase)
MOTOR	350w	450w	550w	750w	550w	750w	750w	1100w	1100w
SPEED RANGE	580 - 2650rpm	300 - 2550rpm	220 - 2800rpm	150 - 3000rpm	220 - 2800rpm	150 - 3000rpm	280 - 2380rpm	150 - 2500rpm	150 - 2500rpm
SPEED SETTINGS	5	12	16	16	16	16	12	12	12
DRILL BIT SIZE Ø	1.5 - 13mm	3 - 16mm	3 - 16mm	5 - 20mm	3 - 16mm	5 - 20mm	5 - 20mm	5 - 20mm	5 - 20mm
MAX. DRILLING CAPACITY	13mm	16mm	16mm	20mm	16mm	20mm	25mm	32mm	32mm
SPINDLE TAPER	B16	B16	MT2	MT2	MT2	MT2	MT3	MT4	MT4
SWING	210mm	260mm	325mm	360mm	316mm	360mm	350mm	506mm	506mm
MAX. SPINDLE STROKE	50mm	60mm	80mm	80mm	80mm	80mm	80mm	120mm	120mm
OVERALL HEIGHT	580mm	840mm	975mm	1000mm	1570mm	1575mm	1575mm	1720mm	1720mm
EX. VAT	£129.99	£199.99	£319.99	£379.99	£339.99	£399.99	£479.99	£799.99	£829.99
INC. VAT	£155.99	£239.99	£383.99	£455.99	£407.99	£479.99	£575.99	£959.99	£995.99

FLOOR-STANDING OPTIONS



16 mm

01714
MAX. DRILLING CAPACITY
(MILD STEEL)



20 mm

01715
MAX. DRILLING CAPACITY
(MILD STEEL)



25 mm

01716
MAX. DRILLING CAPACITY
(MILD STEEL)



32 mm

01717, 01718
MAX. DRILLING CAPACITY
(MILD STEEL)

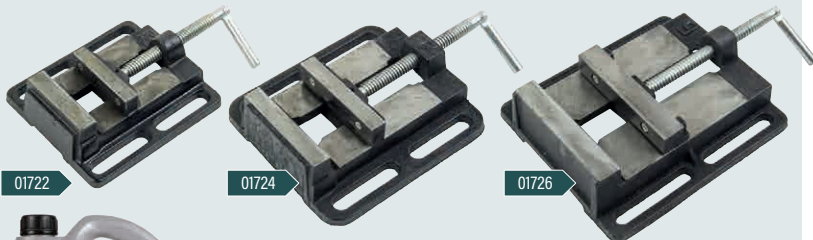

01722

01724

01726



Item No	DESCRIPTION	EX. VAT	INC. VAT
02353	SIP Advanced Universal Neat Metalworking Fluid - 5Ltr	£38.19	£45.83
01722	SIP 2.5" Drill Vice	£16.39	£19.67
01724	SIP 5" Drill Vice	£30.59	£36.71
01726	SIP 6" Drill Vice	£35.99	£43.19

SIP CHUCK GUARDS



Item No	DESCRIPTION	EX. VAT	INC. VAT
66609	SIP 40mm Chuck Guard (for 01710, 01711)	£11.99	£14.39
07662	SIP 55mm Chuck Guard (for 01712, 01713, 01714, 01715)	£15.29	£18.35
07664	SIP 65mm Chuck Guard (for 01716)	£17.49	£20.99
68328	SIP 75mm Chuck Guard (for 01717, 01718)	£20.69	£24.83

SIP PROFESSIONAL METAL-CUTTING CIRCULAR SAWS & ABRASIVE CUT-OFF SAW

Metal-cutting circular saws designed for industrial applications.

01554

01565

VICE FOR PRECISE & ACCURATE CUTTING, REDUCES MATERIAL VIBRATION
STURDY CAST IRON CONSTRUCTION
PEDESTAL STAND WITH INTEGRAL COOLANT PUMP

NEW ELECTRIC PUMP COOLING SYSTEM

For blade and workpiece cooling
Extends working life of the saw blade

SWIVEL HEAD; PERFECT FOR ANGLE CUTTING

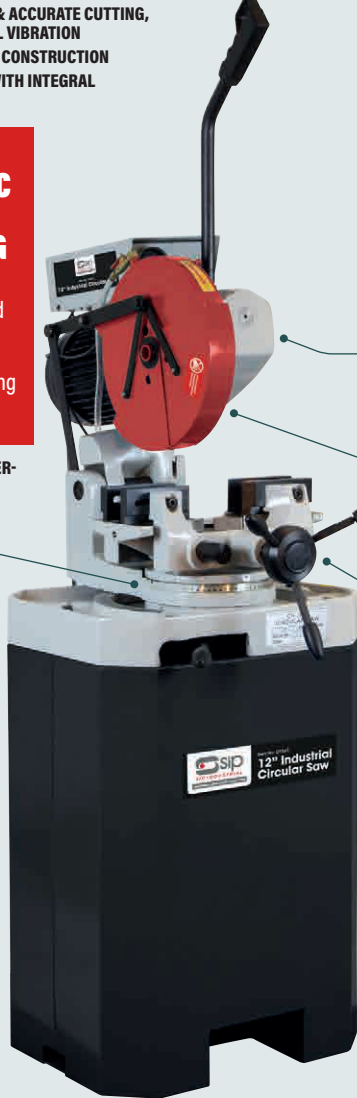

PULL-DOWN HANDLE WITH CONTROL SWITCH



ON/OFF SWITCH WITH E-STOP CONTROL

HEAVY-DUTY MOTOR; PERFECT FOR WORKSHOP APPLICATIONS

SLOW-CUTTING SAW BLADE; ENHANCED BLADE LIFE, IDEAL FOR FERROUS METAL APPLICATIONS

QUICK RELEASE VICE HANDLE; IDEAL FOR REPETITIVE CUTTING

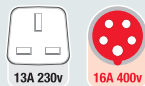

SIP robust cut-off saw solution for metalworking teams.

01307

STRONGER HEAD SUPPORT WITH INDUSTRIAL GRIP 'N' TRIGGER

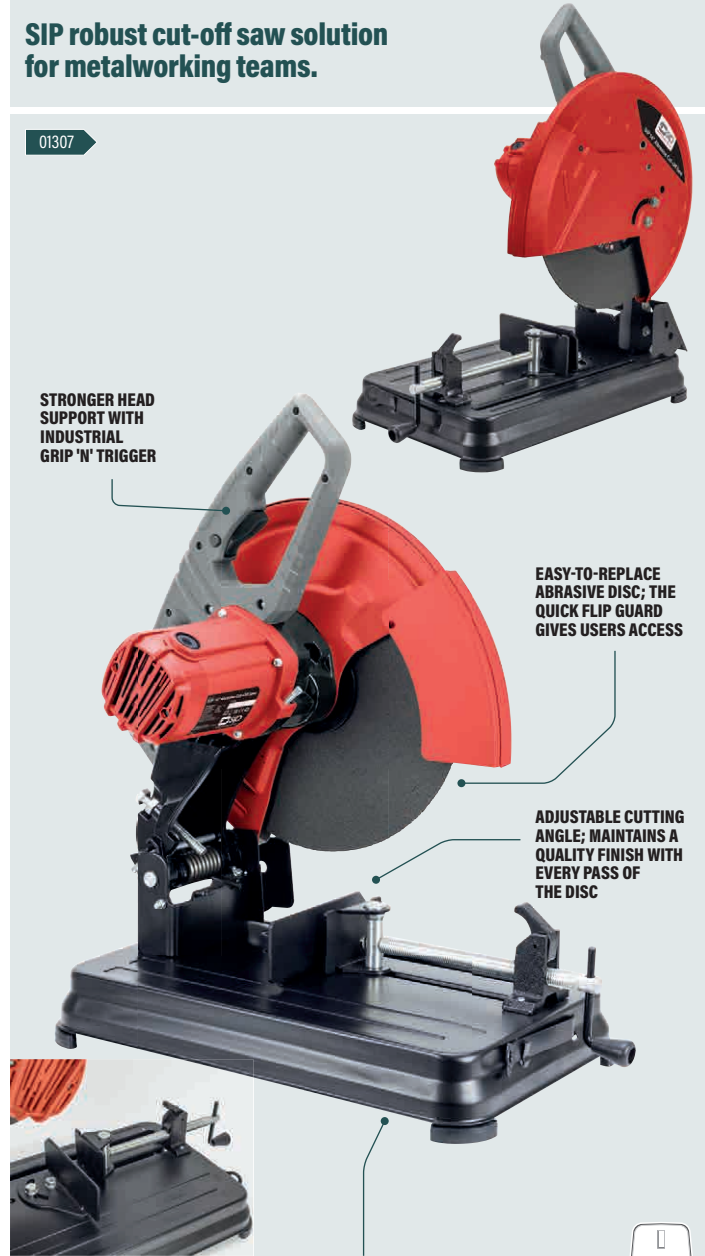

EASY-TO-REPLACE ABRASIVE DISC; THE QUICK FLIP GUARD GIVES USERS ACCESS

ADJUSTABLE CUTTING ANGLE; MAINTAINS A QUALITY FINISH WITH EVERY PASS OF THE DISC

ADJUSTABLE HEAVY-DUTY VICE

ROBUST BASE; FOR IMPROVED STABILITY



Item No	01554	01565
MODEL	SIP 10" INDUSTRIAL CIRCULAR SAW	SIP 12" INDUSTRIAL CIRCULAR SAW
INPUT SUPPLY	230v (13A)	400v (5A)
MOTOR	1.1kW (1.5hp)	750w (1hp) / 1.3kW (1.7hp)
BLADE SPEEDS	42rpm	18rpm @ 1hp / 36rpm @ 1.7hp
CUTTING CAPACITY	@ 90°: 60mm (round) / 75 x 45mm (box) @ 45°: 55mm (round) / 55 x 45mm (box)	@ 90°: 100mm (round) / 140 x 90mm (box) @ 45°: 90mm (round) / 100 x 90mm (box)
BLADE SIZE	250mm max.	315mm max.
EX. VAT	£1599.99	£2299.99
INC. VAT	£1919.99	£2759.99

Item No	01307
MODEL	SIP 14" ABRASIVE CUT-OFF SAW
INPUT SUPPLY	230v (13A)
MOTOR	2000w
BLADE SPEEDS	3800rpm
CUTTING CAPACITY	@ 90°: 130mm (round) / 120 x 120mm (box) / 180 x 85mm (rect.) / 130 x 130mm (angle) @ 45°: 110mm (round) / 90 x 90mm (box) 100 x 80mm (rect.) / 90 x 90mm (angle)
BLADE SIZE	355mm (14")
EX. VAT	£169.99
INC. VAT	£203.99

SIP METAL-CUTTING CIRCULAR SAW BLADES & DISCS

Item No	DESCRIPTION	EX. VAT	INC. VAT
06891	SIP 14" Abrasive Disc (for 01307)	£7.69	£9.23
05210	SIP Blade - 250 x 2.0 x 32mm Z160 T5 (for 01554)	£76.29	£91.55
05212	SIP Blade - 250 x 2.0 x 32mm Z200 T4 (for 01554)	£76.29	£91.55
05199	SIP Blade - 315 x 2.5 x 40mm Z160 T5 (for 01565)	£139.99	£167.99



TO PLACE AN ORDER: 01509 500500



SIP PROFESSIONAL SWIVEL HEAD METAL-CUTTING BANDSAWS

Metal-cutting bandsaws designed for professional heavy-duty applications.

All bandsaws supplied with Bi-Metal, Vari-pitch blades

01572

THREE SPEED BELT DRIVEN TRANSMISSION SYSTEM
MANUAL BLADE TENSIONER
ADJUSTABLE CAST-IRON VICE



CAST IRON SWIVEL BOW; REDUCED VIBRATION, INCREASED ACCURACY & QUICK ANGLE ADJUSTMENTS



STAND OR BENCH MOUNTABLE
SUPPLIED WITH STABLE AND ROBUST PRESSED STEEL STAND



01593

HEAVY-DUTY MOTOR
4 SPEED BELT-DRIVEN GEARBOX; FOR VARYING MATERIAL THICKNESSES & TYPES
CAST IRON SWIVEL HEAD; REDUCED VIBRATION, INCREASED ACCURACY & QUICK ANGLE ADJUSTMENTS
ADJUSTABLE HYDRAULIC RAM DAMPENER; FOR SMOOTH CUTTING DESCENT AND CONTROL, AIDS BLADE PERFORMANCE
COOLANT SYSTEM; EXTENDS BLADE LIFE AND COOLS THE CUTTING AREA

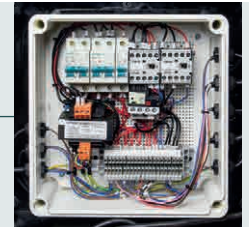

SAFETY FEATURE; 24V CONTROL CIRCUIT



Item No	MODEL	INPUT SUPPLY	MOTOR	SPEEDS	CUTTING CAPACITY			FEATURES	EX. VAT	INC. VAT
					●	■	■			
01572	SIP 6" SWIVEL HEAD SAW	230v (13A)	370w (0.5hp)	3 speeds 20/29/50mtr/min	@ 0°: 110mm @ 45°: 85mm	@ 0°: 110 x 110mm @ 45°: 85 x 85mm	@ 0°: 110 x 150mm @ 45°: 85 x 110mm	SWIVEL BOW	£529.99	£635.99
01593	SIP 8" SWIVEL HEAD SAW	230v (13A)	1.1kW (1.5hp)	4 speeds 22/33/45/65mtr/min	@ 0°: 178mm @ 45°: 127mm	@ 0°: 178 x 178mm @ 45°: 127 x 127mm	@ 0°: 178 x 210mm @ 45°: 85 x 140mm	SWIVEL BOW	£1899.99	£2279.99

FOR REPLACEMENT BLADES - SEE PAGE 38

TO PLACE AN ORDER: www.sip-group.com

SIP PROFESSIONAL METAL-CUTTING BANDSAWS

Metal-cutting bandsaws designed for professional heavy-duty applications.

All bandsaws supplied with
Bi-Metal, Vari-pitch blades

01594

01595

- 4 SPEED BELT-DRIVEN GEARBOX; FOR VARYING MATERIAL THICKNESSES & TYPES
- COOLANT SYSTEM; EXTENDS BLADE LIFE AND COOLS THE CUTTING AREA
- CAST IRON HEAD; REDUCED VIBRATION, INCREASED ACCURACY
- LARGE ADJUSTABLE VICE; IDEAL FOR LARGE STEEL SECTIONS, AND FOR STRAIGHT & ANGLE CUTS
- ADJUSTABLE HYDRAULIC RAM DAMPENER; FOR SMOOTH CUTTING DESCENT AND CONTROL, AIDS BLADE PERFORMANCE
- SINGLE & THREE PHASE HEAVY-DUTY MOTOR MODELS; FOR PROFESSIONAL WORKSHOPS

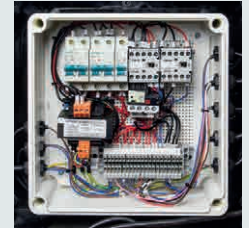

SAFETY FEATURE;
24V CONTROL CIRCUIT



sip
SIP INDUSTRIAL
Item No: 01594 | 1 Phase
12" Metal Cutting Bandsaw

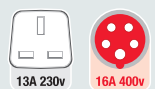

Item No	MODEL	INPUT SUPPLY	MOTOR	SPEEDS	CUTTING CAPACITY			FEATURES	EX. VAT	INC. VAT
					●	■	▬			
01594	SIP 12" 230V SAW (1ph)	230v (13A)	1.1kW (1.5hp)	4 speeds 22/33/45/65mtr/min	@ 0°: 178mm @ 45°: 127mm	@ 0°: 178 x 178mm @ 45°: 127 x 127mm	@ 0°: 178 x 305mm @ 45°: 120 x 125mm	-	£1459.99	£1751.99
01595	SIP 12" 400V SAW (3ph)	400v (5A)	0.75kW (1hp)	4 speeds 22/33/45/65mtr/min	@ 0°: 178mm @ 45°: 127mm	@ 0°: 178 x 178mm @ 45°: 127 x 127mm	@ 0°: 178 x 305mm @ 45°: 120 x 125mm	-	£1599.99	£1919.99

FOR REPLACEMENT BLADES - SEE PAGE 38

TO PLACE AN ORDER: ☎ 01509 500500



Metal-cutting bandsaws designed for professional heavy-duty applications.

All bandsaws supplied with Bi-Metal, Vari-pitch blades

01573



INTEGRATED COOLANT SYSTEM



HEAVY-DUTY CAST IRON BOW; REDUCED VIBRATION, INCREASED ACCURACY



ADJUSTABLE CAST IRON VICE; FOR LARGE STEEL SECTIONS, STRAIGHT & ANGLE CUTS



DIRECT DRIVE MOTOR GEARBOX WITH 3 SPEED QUICK-CHANGE SWITCH FOR EASY BLADE CUTTING SPEED SELECTION

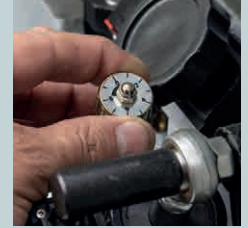

ADJUSTABLE HYDRAULIC RAM DAMPENER

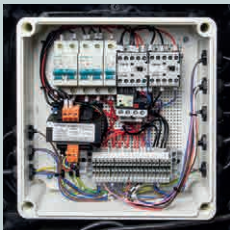

SAFETY FEATURE; 24V CONTROL CIRCUIT



Item No	MODEL	INPUT SUPPLY	MOTOR	SPEEDS	CUTTING CAPACITY			FEATURES	EX. VAT	INC. VAT
01573	SIP 12" 230V GEAR-DRIVE SAW	230v (13A)	1.1kW (1.5hp)	3 speeds 39/55/67mtr/min	@ 0°: 180mm @ 45°: 110mm	@ 0°: 180 x 180mm @ 45°: 110 x 110mm	@ 0°: 178 x 305mm @ 45°: 110 x 180mm	GEAR DRIVEN	£1599.99	£1919.99

FOR REPLACEMENT BLADES - SEE PAGE 38

SIP PROFESSIONAL METAL-CUTTING BANDSAWS

Metal-cutting bandsaw designed for professional heavy-duty applications.

All bandsaws supplied with Bi-Metal, Vari-pitch blades

01599
01597

- ADJUSTABLE HYDRAULIC RAM DAMPENER; FOR SMOOTH CUTTING DESCENT AND CONTROL, AIDS BLADE PERFORMANCE
- COOLANT SYSTEM; EXTENDS BLADE LIFE AND COOLS THE CUTTING AREA
- LARGE ADJUSTABLE VICE; IDEAL FOR LARGE STEEL SECTIONS, FOR STRAIGHT & ANGLE CUTS
- HEAVY-DUTY CAST IRON BOW; REDUCED VIBRATION, INCREASED ACCURACY
- 4 SPEED BELT-DRIVEN GEARBOX
- SINGLE & THREE PHASE HEAVY-DUTY MOTOR MODELS; FOR PROFESSIONAL WORKSHOPS

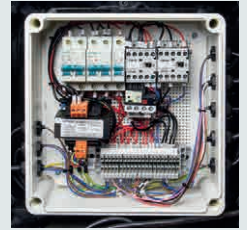

SAFETY FEATURE; 24V CONTROL CIRCUIT



TO PLACE AN ORDER: ☎ 01509 500500

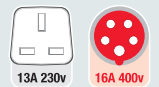

Item No	MODEL	INPUT SUPPLY	MOTOR	SPEEDS	CUTTING CAPACITY			FEATURES	EX. VAT	INC. VAT
					●	■	▬			
01599	SIP 18" 230V SAW (1ph)	230v (13A)	1.5kW (2hp)	4 speeds 29/50/73/95mtr/min	@ 90°: 254mm @ 45°: 150mm	@ 0°: 230 x 230mm @ 45°: 130 x 130mm	@ 90°: 127 x 457mm @ 45°: 150 x 190mm	-	£4399.99	£5279.99
01597	SIP 18" 400V SAW (3ph)	400v (5A)	1.5kW (2hp)	4 speeds 29/50/73/95mtr/min	@ 90°: 254mm @ 45°: 150mm	@ 0°: 230 x 230mm @ 45°: 130 x 130mm	@ 90°: 127 x 457mm @ 45°: 150 x 190mm	-	£4699.99	£5639.99

FOR REPLACEMENT BLADES - SEE PAGE 38



01520

01524

MANUAL PULL-DOWN HANDLE WITH CONTROL SWITCH
ADJUSTABLE HYDRAULIC RAM DAMPENER
MANUAL OR SEMI-AUTOMATIC FEED CONTROL;
IDEAL FOR INDIVIDUAL MANUAL CUTTING
OR SEMI-AUTOMATIC OPERATION;
FOR LARGER CUTS



COOLANT SYSTEM;
EXTENDS BLADE LIFE AND
COOLS THE CUTTING AREA



CAST IRON SWIVEL
BOW HEAD AND
QUICK ANGLE
ADJUSTMENTS
UP TO 60°

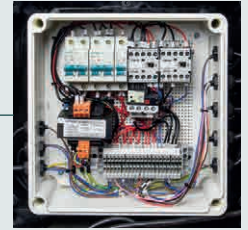

SAFETY FEATURE;
24V CONTROL CIRCUIT



CAST IRON VICE WITH QUICK
RELEASE HANDLE; IDEAL FOR
REPETITIVE CUTTING



Item No	MODEL	INPUT SUPPLY	MOTOR	SPEEDS	CUTTING CAPACITY			BLADE SIZE	EX. VAT	INC. VAT
					●	■	▣			
01520	SIP 8" SWIVEL HEAD PULL-DOWN SAW	230v (13A)	1.1kW (1.5hp)	80mtr/min	@ 90°: 170mm @ 60°: 70mm @ 45°: 120mm	@ 90°: 170 x 170mm @ 60°: 60 x 60mm @ 45°: 110 x 110mm	@ 90°: 170 x 200mm @ 60°: 60 x 60mm @ 45°: 110 x 110mm	20 x 0.9 x 2085mm	£1899.99	£2279.99
01524	SIP 10" SWIVEL HEAD PULL-DOWN SAW	230v (13A)	1.1kW (1.5hp)	72mtr/min	@ 90°: 227mm @ 60°: 90mm @ 45°: 150mm	@ 90°: 200 x 200mm @ 60°: 100 x 100mm @ 45°: 160 x 160mm	@ 90°: 260 x 110mm @ 60°: 85 x 85mm @ 45°: 150 x 125mm	27 x 0.9 x 2455mm	£2479.99	£2975.99

FOR REPLACEMENT BLADES - SEE PAGE 38

SIP PROFESSIONAL PULL-DOWN METAL-CUTTING BANDSAWS

Metal-cutting bandsaws designed for professional heavy-duty applications.

All bandsaws supplied with Bi-Metal, Vari-pitch blades

01526

MANUAL BLADE TENSIONER WITH GAUGE

INFINITELY VARIABLE SPEED RANGE & DIGITAL DISPLAY FOR CUTTING SPEED

SAFETY FEATURE; 24V CONTROL CIRCUIT

HEAVY-DUTY CAST IRON SWIVEL BOW HEAD

ADJUSTABLE CAST-IRON VICE

NEW PRODUCT

GEARBOX DRIVEN

SWIVEL HEAD

13A 230v

SIP INDUSTRIAL

Item No	MODEL	INPUT SUPPLY	MOTOR	SPEEDS	CUTTING CAPACITY			BLADE SIZE	EX. VAT	INC. VAT
01526	SIP 10" VARI-SPEED SWIVEL HEAD SAW	230v (13A)	1.1kW (1.5hp)	Variable 0 - 90mtr/min	@ 0°: 220mm @ 30°: 190mm @ 45°: 160mm @ 60°: 100mm	@ 0°: 200mm @ 30°: 180mm @ 45°: 160mm @ 60°: 100mm	@ 0°: 260 x 140mm @ 30°: 200 x 140mm @ 45°: 160 x 140mm @ 60°: 120 x 140mm	27 x 0.9 x 3160mm	£2799.99	£3359.99

SIP METAL-CUTTING BANDSAW BLADES

Item No	DESCRIPTION	EX. VAT	INC. VAT
WK04-00650	SIP Blade - 1630 x 12.5 x 0.64mm Carbon Steel 16 TPI (for 01572)	£29.99	£35.99
07739	SIP Blade - 2362 x 20 x 0.9mm M42 5/8 TPI (for 01593, 01594, 01595)	£36.99	£44.39
01427	SIP Blade - 3280 x 27 x 0.9mm M42 4/6 TPI (for 01597, 01599)	£58.89	£70.67
WK04-00400	SIP Blade - 2085 x 20 x 0.9mm M42 4/6 TPI (for 01520)	£38.19	£45.83
WK04-00401	SIP Blade - 2455 x 27 x 0.9mm M42 4/6 TPI (for 01524)	£49.99	£59.99
WK04-00651	SIP Blade - 2450 x 27 x 0.9mm M42 4/6 TPI (for 01526)	£79.99	£95.99
WK04-00652	SIP Blade - 2360 x 19 x 0.9mm M42 4/6 TPI (for 01573)	£59.99	£71.99
WK04-00653	SIP Blade - 3160 x 27 x 0.9mm M42 4/6 TPI (for 01530)	£109.99	£131.99

SIP ADVANCED UNIVERSAL NEAT METALWORKING FLUID
SEE PAGE 31 FOR PRICE



TO PLACE AN ORDER: ☎ 01509 500500



SIP PROFESSIONAL PULL-DOWN METAL-CUTTING BANDSAWS

01530

MANUAL OR SEMI-AUTOMATIC FEED CONTROL;
IDEAL FOR INDIVIDUAL MANUAL CUTTING OR SEMI-AUTOMATIC OPERATION FOR LARGER CUTS
INTEGRATED COOLANT SYSTEM

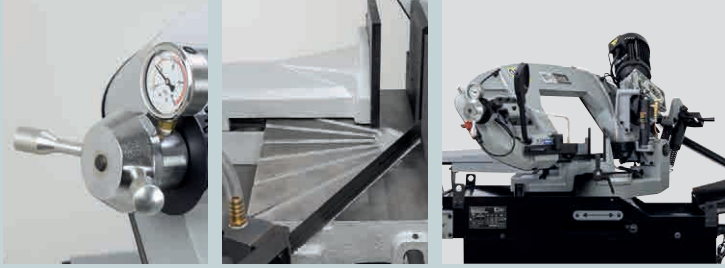

MANUAL BLADE TENSIONER
WITH GAUGE FOR PRECISE
SETTING
MANUAL PULL-DOWN
HANDLE WITH CONTROL
SWITCH

45° (LEFT) UP TO
60° (RIGHT) FOR DOUBLE
MITRE FACILITY

HEAVY-DUTY CAST IRON
SWIVEL BOW HEAD



ADJUSTABLE HYDRAULIC
RAM DAMPENER



DIRECT-DRIVE MOTOR
GEARBOX FOR POSITIVE
AND PRECISE CUTTING



SAFETY FEATURE;
24V CONTROL CIRCUIT

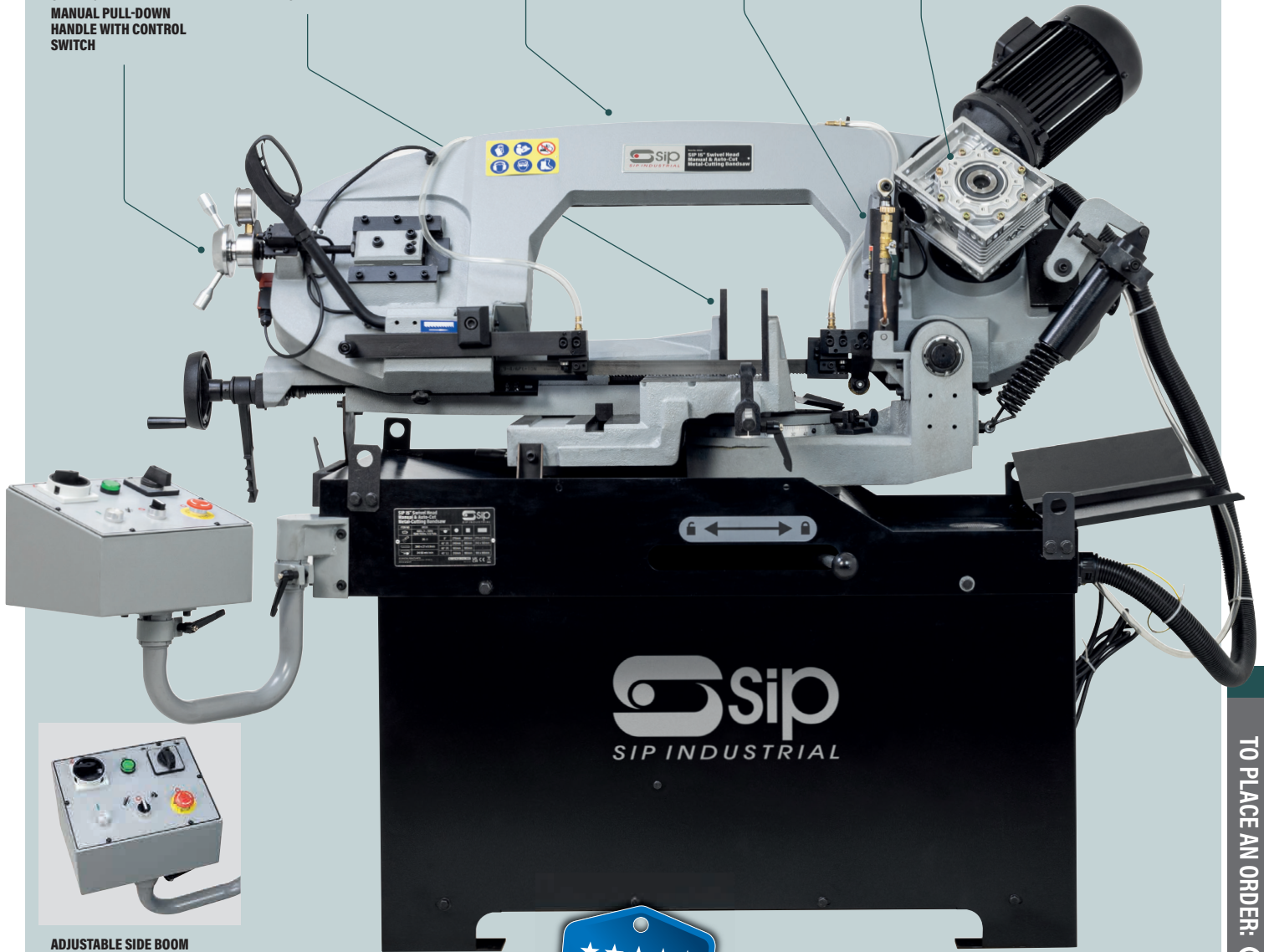

ADJUSTABLE SIDE BOOM
MOUNTED CONTROL BOX



Item No	MODEL	INPUT SUPPLY	MOTOR	SPEEDS	CUTTING CAPACITY			BLADE SIZE	EX. VAT	INC. VAT
01530	SIP 15" SWIVEL HEAD MANUAL & AUTO-CUT SAW	400v (3 Phase)	1.5kW (2.0hp)	2 speeds 34/68mtr/min	@ 0°: 270mm @ 45°: 240mm @ 60°: 160mm @ 45°(L): 210mm	@ 0°: 260mm @ 45°: 180mm @ 60°: 100mm @ 45°(L): 180mm	@ 0°: 220 x 370mm @ 45°: 160 x 240mm N/A @ 45°(L): 150 x 180mm	27 x 0.9 x 3160mm	£4999.99	£5999.99

TO PLACE AN ORDER: www.sip-group.com

SIP METAL BELT LINISHERS

SIP belt liners designed for trade & professional applications. Supplied as standard with zirconium bonded liner belt for improved finishing on all types of metals including stainless steel.

01960



METAL DUST EXTRACTION PORT

TWO POINT BELT ACCESS WHEEL AND FULL PLATEN

LONG LASTING ZIRCONIUM BONDED BELT FOR USE ON METALS INCLUDING STAINLESS STEEL



PEDESTAL STAND INCLUDED

BENCH-MOUNTABLE FOR ADDED FLEXIBILITY



13A 230v

01948

01949

LONG LASTING ZIRCONIUM BONDED BELT FOR USE ON METALS INCLUDING STAINLESS STEEL

NVR SWITCH FOR ADDED SAFETY

LINISHING HEAD TILT; TO ACCOMMODATE A VARIETY OF DIFFERENT MATERIAL LENGTHS AND SIZES

HEAVY-DUTY PEDESTAL STAND



ADJUSTABLE TOOL SUPPORT; FOR ACCURATE POSITIONING OF THE WORKPIECE WITH ANGLE ADJUSTMENT



PEDESTAL STAND INCLUDED



3 POINT BELT ACCESS; ON WHEEL, PLATEN TOP AND FULL PLATEN FOR A VARIETY OF LINISHING APPLICATIONS



16A 400v

Item No	01960	01948	01949
MODEL	SIP 4" BELT LINISHER	SIP HEAVY-DUTY 3" BELT LINISHER	SIP HEAVY-DUTY 6" BELT LINISHER
INPUT SUPPLY	230v (13A)	400v (3ph)	400v (3ph)
MOTOR	1.5kW (2hp)	3kW (4hp)	3kW (4hp)
BELT SIZE	1200 x 100mm / P60	2000 x 75mm / P80	2000 x 150mm / P80
BELT SPEED	19mtr/s	34mtr/s	34mtr/s
FLAT GRINDING	860mm	530mm	530mm
CONTACT WHEEL	125 x 100mm	200 x 75mm	225 x 150mm
WORKING HEIGHT	800mm	475 - 1240mm	475 - 1240mm
WEIGHT	40kg	75kg	100kg
EX. VAT	£499.99	£899.99	£1099.99
INC. VAT	£599.99	£1079.99	£1319.99

SIP REPLACEMENT LINISHER BELTS

Item No	DESCRIPTION	EX. VAT	INC. VAT
WK05-00467	SIP 710 x 50mm Aluminium Oxide Belt P80 (for 01459)	£3.99	£4.79
WK05-00286	SIP 1220 x 80mm Zirconium Belt P80 (for 01960)	£13.49	£16.19
08662	SIP 2000 x 75mm Zirconium Belt P80 (for 01948)	£14.19	£17.03
08668	SIP 2000 x 150mm Aluminium Oxide Belt P60 (for 01949)	£29.49	£35.39
08670	SIP 2000 x 150mm Aluminium Oxide Belt P80 (for 01949)	£26.19	£31.43
08678	SIP 2000 x 150mm Zirconium Belt P80 (for 01949)	£28.39	£34.07



TO PLACE AN ORDER: 01509 500500



SIP METAL DUST COLLECTOR & 3-in-1 METAL SHEAR, FOLDER, PYRAMID ROLLER

SIP METAL DUST COLLECTOR

Delivers powerful airflow for at-source metal grinding extraction in workshop or manufacturing environments

Compatible with a variety of grinding, finishing and fettling equipment, this easy-to-manoeuvre dust collector is suitable for processing ferrous and non-ferrous metals and stainless steel

230V (13A) INPUT SUPPLY

750W (1HP) BRUSHLESS INDUCTION MOTOR

1100mtr³/hr MAXIMUM AIRFLOW



POWERFUL BRUSHLESS INDUCTION MOTOR



SUPPLIED WITH FLAME RETARDANT FILLER BAG



Item No: 01996
£499.99 EX.VAT
 £599.99 INC.VAT



EASY ACCESS WASTE COLLECTION TRAY



2x 100mm Ø OUTLETS ONE ON EACH SIDE OF UNIT



STURDY HANDLE FOR EASY MOVEMENT

SIP 3-IN-1 METAL SHEAR, FOLDER & PYRAMID ROLLER

The SIP 3-in-1 Metal Shear, Folder & Pyramid Roller is ideal for cutting, folding and rolling sheet metal sections. This includes mild steel, aluminium, coated steels and stainless steel.

METAL SHEAR (max. plate width 760mm)

- A guillotine function uses a scissor action blade to accurately cut sheet metal across a fixed position to a max. width of 760mm
- 1.0mm max. shearing thickness
- Fitted with a clamp bar for holding sheet metal in place and an adjustable backstop to measure depth of cut

METAL FOLDER

- Ideal for folding and shaping sheet metal as a part of a production or manufacturing processes
- 90° max. bending angle
- 1.0mm max. bending thickness
- Perfect for creating steel box fabrications and enclosures for circuitry and electronics
- Adjustable folding formers allow for various sized items to be produced

PYRAMID ROLLER

- Three adjustable pyramid rollers allow sheet metal to be bent and rolled repeatedly to desired specification
- Min. rolling Ø 39mm
- Max. rolling thickness 1.0mm
- Ideal for forming metal tubes, ducting and rings of varying thicknesses and diameters
- Safety cover guard for added user safety

ADJUSTABLE MACHINE HANDLE

CAST IRON AND STEEL CONSTRUCTION

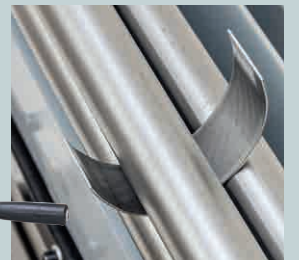

Item No: 01529
£729.99 EX.VAT
 £875.99 INC.VAT

TO PLACE AN ORDER: www.sip-group.com

SIP METAL BUFFER POLISHER & PROFESSIONAL BENCH GRINDER/LINISHERS

07698

SIP 8" METAL BUFFER POLISHER

IDEAL FOR BUFFING AND POLISHING METAL MATERIALS WHEN FINISHING OR PROCESSING METALWORK ITEMS.
 HIGHLY VERSATILE AND DURABLE, BUFFER/POLISHER MACHINES ARE AN ESSENTIAL ITEM FOR ANY PROFESSIONAL METALWORK WORKSHOP.
 QUALITY BEARINGS AND MACHINED PARTS FOR LONG LIFE USE
 ROBUST CAST IRON BASE ENSURES STABILITY WHEN IN OPERATION
 EFFECTIVE FORCED AIR COOLING FOR INCREASED PERFORMANCE
 CAST IRON BASE WITH RUBBER FEET FOR REDUCED VIBRATION



01459

SIP 8"x 2" BENCH GRINDER/LINISHER

A DUAL PROCESS METALWORK MACHINE IDEAL FOR GRINDING, SHAPING AND SMOOTHING METAL WORKPIECES. IT'S ALSO SUITABLE FOR SHARPENING WORKSHOP TOOLS.
 THIS HIGHLY VERSATILE MACHINE FEATURES A DURABLE GRINDING WHEEL AND 0°-45° TILTING LINISHER BELT WITH AN ADJUSTABLE LED WORK LIGHT FOR GREATER PRECISION AND VISIBILITY
 CAST IRON BASE WITH RUBBER FEET FOR REDUCED VIBRATION



ADJUSTABLE LED WORKLIGHT

07625

07628

07650

SIP PROFESSIONAL BENCH GRINDERS

OFFERING HEAVY-DUTY PERFORMANCE IN A RANGE OF GENERAL METAL GRINDING APPLICATIONS INCLUDING SHARPENING OF TOOLS, DRILL BITS, CHISELS, AND KNIVES THANKS TO FINE AND COARSE GRIT WHEELS; IDEAL FOR SMALL AND LARGE METAL REMOVAL
 CAST IRON BASES WITH RUBBER FEET FOR REDUCED VIBRATION



ADDITIONAL WIRE WHEEL SUPPLIED WITH ITEMS: 07625 & 07628

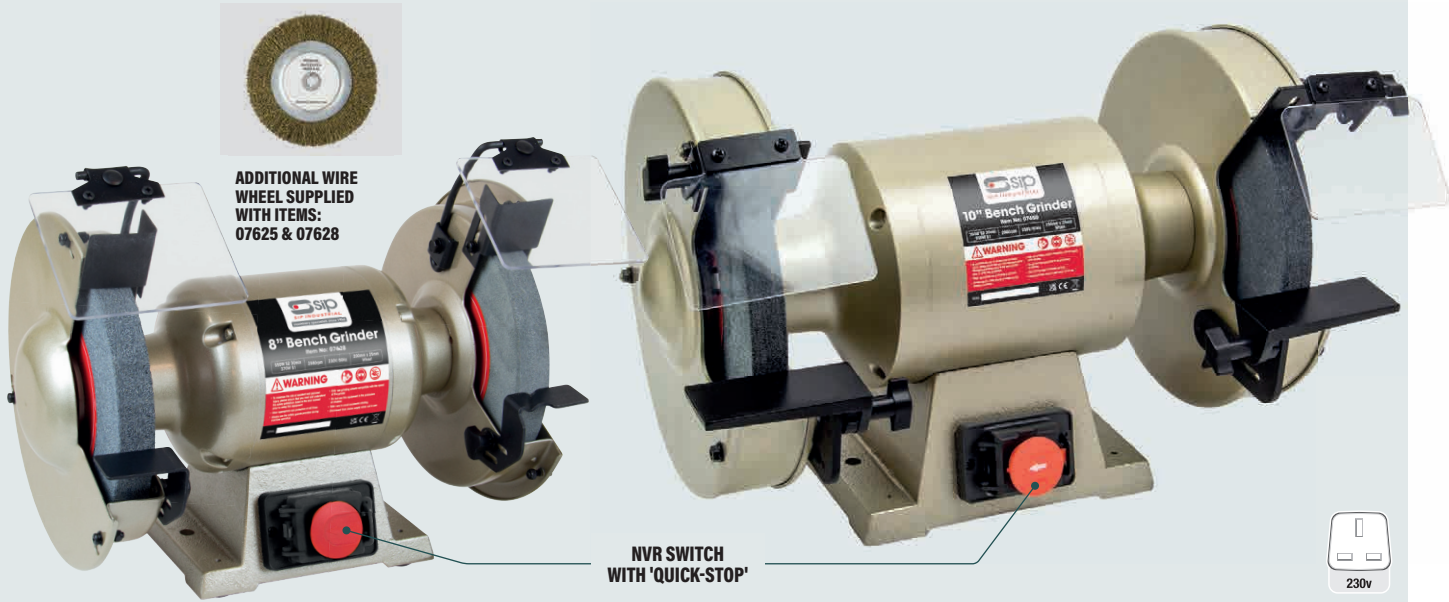

NVR SWITCH WITH 'QUICK-STOP'



TO PLACE AN ORDER: 01509 500500

Item No	07698	01459	07625	07628	07650
MODEL	SIP 8" METAL BUFFER POLISHER	SIP 8"x 2" BENCH GRINDER/LINISHER	SIP 6" PROFESSIONAL BENCH GRINDER	SIP 8" PROFESSIONAL BENCH GRINDER	SIP 10" PROFESSIONAL BENCH GRINDER
INPUT SUPPLY	230v 50Hz	230v 50Hz	230v 50Hz	230v 50Hz	230v 50Hz
MOTOR	550w S2 30mins / 370w S1	550w S2 30mins / 370w S1	370w S2 30mins / 250w S1	550w S2 30mins / 370w S1	750w S2 30mins / 550w S1
WHEEL SPEED	2980rpm	2980rpm	2980rpm	2980rpm	2980rpm
WHEEL DIAMETER	8" (200mm)	8" (200mm)	6" (150mm)	8" (200mm)	10" (250mm)
WHEEL WIDTH	3/4" (10mm)	3/4" (10mm)	3/4" (20mm)	1" (25mm)	1" (25mm)
BORE SIZE	5/8" (15.88mm)	5/8" (15.88mm)	1/2" (12.7mm)	5/8" (15.88mm)	3/4" (20mm)
BELT SIZE / GRIT	n/a	710 x 50mm / P60	n/a	n/a	n/a
ADDITIONAL FEATURES	2x MOP wheels for 1st & 2nd finishing	Integrated work light	Wire Wheel included	Wire Wheel included	n/a
EX. VAT	£99.99	£129.99	£109.99	£129.99	£219.99
INC. VAT	£119.99	£155.99	£131.99	£155.99	£263.99

**OPTIONAL:
SIP3 TIER CART**
SEE PAGE 44 FOR PRICE



SIP INVERTER INDUCTION HEATERS

Perfect for releasing seized fixings, components and parts from vehicles. Also suitable for a variety of manufacturing and heavy-duty processes.

Easy to control and highly efficient, our new range safely reaches temperatures of up to 1000°C in 30 seconds and offer greater levels of safety compared to oxy-acetylene methods.

Features including liquid cooled induction cable and torch maximise product life and ensure user safety.

INTERCHANGEABLE COILS AND PADS

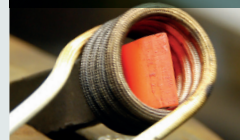

FLEXIBLE AND EASY TO USE



MOBILE, POWERFUL SOLUTIONS



01156

POWERFUL 1500W MOTOR



4-PIECE INDUCTION KIT

Supplied with a set of multi-use induction tools

- (1) Helix Coils:
(x1) 19mm & (x1) 26mm Ø - both 220mm length
- (2) Flat Coil:
(x1) 65mm width & 220mm length
- (3) Flexi-Induction Lead:
(x1) 800mm length

HOUSED IN A STURDY BLOW MOULDED CARRY/STORAGE CASE



SIP Induction Heater Coolant

- Specially formulated for use with items 01157 & 01158
- Supplied in 3ltr or 10ltr container



Item No: HY02-00958 - 3L

£32.99 EX.VAT
£39.59 INC.VAT

Item No: HY02-00980 - 10L

£99.99 EX.VAT
£119.99 INC.VAT

01157

01158



OPTIONAL
SIP 3 TIER CART
(05714) SEE PAGE 44



Item No	01156	01157	01158
MODEL	SIP 1500W INDUCTION HEATER KIT	SIP 3700W INDUCTION HEATER	SIP 10000W INDUCTION HEATER
INPUT SUPPLY	230v (13A)	230v (16A)	400v 3-Phase
INDUCTION POWER	1.5kW	3.7kW	10kW
POWER STEPS	Fixed	Infinitely Variable	Multi-level
HEAT RANGE	800°C (maximum)	1000°C (maximum)	1000°C (maximum)
INDUCTION CABLE LENGTH	850mm	2mtr	5mtr
POWER CABLE LENGTH	3mtr	3mtr	5mtr
COOLING SYSTEM	Fan Cooled Torch	Liquid Cooled Torch, Induction Cable & Inverter Unit	Liquid Cooled Torch & Induction Cable
COOLANT TANK CAPACITY	n/a	2.5ltr	10ltr
INVERTER VENTILATION	Cooling Fan	Twin Cooling Fans	Six Cooling Fans
EX. VAT	£649.99	£2499.99	£6299.99
INC. VAT	£779.99	£2999.99	£7559.99

SIP INDUCTION HEATER CONSUMABLES



Item No	FOR ITEM: 01156 (1500w)	EX. VAT	INC. VAT	Item No	FOR ITEM: 01157 (3700w)	EX. VAT	INC. VAT
HY02-00931	Induction Flexi Coil - 800mm	£34.99	£41.99	HY02-00943	Pad Coil Holder Extender	£66.99	£80.39
HY02-00936	Induction Coil Straight - 19/220mm	£21.99	£26.39	HY02-00944	Pad Coil Inclined	£279.99	£335.99
HY02-00939	Induction Coil Straight - 26/220mm	£24.99	£29.99	HY02-00945	Pad Coil Flat	£279.99	£335.99
HY02-00942	Induction Coil Straight - 45/220mm	£25.99	£31.19				

TO PLACE AN ORDER: www.sip-group.com



SIP WELDMATE® MIG & MIG/ARC/TIG WELDERS



POWERFUL AND COMPACT WELDERS, SUITABLE FOR ENTRY LEVEL USERS AND LIGHT INDUSTRY APPLICATIONS.

INFINITELY VARIABLE CONTROL DIALS

EASY TO USE WIRE FEEDER

INTEGRATED MIG WELDING TORCH

05729: GASLESS MIG WELDING

05731 & 05733:

3-IN-1 WELDING FUNCTIONS
PERFORMS BOTH GASLESS
AND GAS MIG WELDING

Supplied with a range of accessories to allow you to weld straight from the box:

- Electrode holder
- Earth cable with clamp
- Gas hose with clamps
- Face shield
- Welding wire reel
- Reel feeder
- Wire brush
- Torch tips
- Spanner



Item No	05729	05731	05733
MODEL	SIP WELDMATE® 100A MIG	SIP WELDMATE® 120A MIG/ARC/TIG	SIP WELDMATE® 160A MIG/ARC/TIG
INPUT SUPPLY	230v (13A)	230v (13A)	230v (16A)
OUTPUT CURRENT	20 - 100A (MIG)	20 - 120A (MIG) / 20 - 100A (ARC) / 20 - 100A (TIG)	20 - 160A (MIG) / 20 - 140A (ARC) / 20 - 140A (TIG)
MIG DUTY CYCLE 15%	100A	120A	160A
OUTPUT POWER SETTINGS	Infinitely Variable	Infinitely Variable	Infinitely Variable
APPROX. WELDING THICKNESS	1.2 - 4.2mm (mild steel)	1.2 - 5.0mm (mild steel)	1.2 - 6.0mm (mild steel)
WIRE SIZE	0.8 and 0.9mm Flux-cored	0.6 - 0.8mm	0.6 - 0.8mm
WIRE SPOOL SIZE	0.7kg	0.7kg	0.7kg / 5kg
WEIGHT	5.4kg	6.0kg	6.8kg
ADDITIONAL FEATURES	-	3-IN-1 FUNCTION (MIG/ARC/TIG)	3-IN-1 FUNCTION (MIG/ARC/TIG)
EX. VAT	£109.99	£169.99	£199.99
INC. VAT	£131.99	£203.99	£239.99

SIP 3 TIER CART

- Suitable for NEW SIP WELDMATE® machines: 05729, 05731, 05733, 05737, 05738, 05739, 05740, 05734
- Suitable for SIP Welding machines: 05705, 05707, 05710, 05711, 05715, 05717, 05723, 05724, 05732, 05736, 05756, 05773, 05770, 05771, 05775, 05781, 05793, 05794
- Suitable for SIP Plasma Cutters: 05782, 05783, 05785, 05787, 05788, 05789
- Suitable for TIGREN models: 08200, 08201, 08202, 08203, 08204

- Wheel-mounted trolley with all-metal design
- Holds gas cylinders of up to 50kg
- Welding accessory storage on lower two tiers



Item No: 05714
£59.99 EX.VAT
£71.99 INC.VAT

SIP LARGE CYLINDER WELDING TROLLEY

- Compatible with all SIP WELDMATE® AUTOPLUS & WELDMATE® PRO Inverter Welders
- Heavy-duty wheel-mounted trolley with all-steel design
- Holds larger gas cylinders of up to 99kg on rear facing footplate
- Cylinders can be secured at two points on trolley via pull-through chains
- Large solid wheels ensure great movability around the workshop



Item No: 05719
£119.99 EX.VAT
£143.99 INC.VAT



NEW RANGE

SIP WELDING

SIP WELDMATE[®] AUTOPLUS MIG/ARC/TIG SYNERGIC WELDERS



PURE · SYNERGIC

ALLOWS FOR AUTONOMOUS CONTROL OF THE WELDING PARAMETERS FOR EASE OF OPERATION

FEATURES A VARIETY OF POWERFUL OUTPUT CAPABILITIES TO MEET DEMANDING APPLICATIONS IN AUTOMOTIVE ENVIRONMENTS

IDEAL FOR AUTOMOTIVE AND SHEET METAL APPLICATIONS

SUPERIOR ARC STABILITY FOR GREATER WELDING CONTROL AND REDUCED SPATTER

SYNERGIC CONTROL FOR SINGLE DIAL ADJUSTMENT OF WELDING VOLTAGE & WIRE FEED SPEED

CAST METAL WIRE FEEDER, SUITABLE FOR MAX. 5KG WIRE REEL

SOFT TOUCH CONTROL PANEL - SELECT BETWEEN WELDING PROCESS, GAS TYPE AND WIRE SIZE

TWIN LED'S FOR WELDING OUTPUT DISPLAY

SUPPLIED WITH 3MTR MIG WELDING TORCH



05737



CLEAR EASY-TO-READ CONTROL PANEL



05738



SIP WELDMATE[®] AUTOPLUS 130A MIG/ARC/TIG SYNERGIC with SIP 3 Tier Welding Cart

- Premium SIP AUTOPLUS 130A Synergic welder
- Cart holds larger size bottles up to 50kg
- Sturdy all-metal construction



Item No: 05737CART

£279.99 EX.VAT
£335.99 INC.VAT

SIP WELDMATE[®] AUTOPLUS 130A MIG/ARC/TIG SYNERGIC with SIP Large Cylinder Welding Trolley

- Premium SIP AUTOPLUS 130A Synergic welder
- Trolley holds larger size bottles up to 99kg
- Heavy-duty wheel-mounted trolley with all steel design



Item No: 05737TROLLEY

£299.99 EX.VAT
£359.99 INC.VAT

SIP WELDMATE[®] AUTOPLUS 160A MIG/ARC/TIG SYNERGIC with SIP 3 Tier Welding Cart

- Premium SIP AUTOPLUS 160A Synergic welder
- Cart holds larger size bottles up to 50kg
- Sturdy all-metal construction



Item No: 05738CART

£329.99 EX.VAT
£395.99 INC.VAT

SIP WELDMATE[®] AUTOPLUS 160A MIG/ARC/TIG SYNERGIC with SIP Large Cylinder Welding Trolley

- Premium SIP AUTOPLUS 160A Synergic welder
- Trolley holds larger size bottles up to 99kg
- Heavy-duty wheel-mounted trolley with all steel design

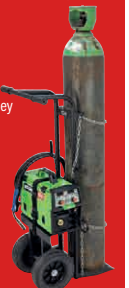

Item No: 05738TROLLEY

£349.99 EX.VAT
£419.99 INC.VAT

**TIG TORCH
AVAILABLE - 05035**
FOR USE WITH 05737, 05738



Item No: 05035

£59.99 EX.VAT
£71.99 INC.VAT

Item No	05737	05738
MODEL	SIP WELDMATE[®] AUTOPLUS 130A MIG/ARC/TIG SYNERGIC	SIP WELDMATE[®] AUTOPLUS 160A MIG/ARC/TIG SYNERGIC
INPUT SUPPLY	230v (13A)	230v (16A)
OUTPUT CURRENT	50 - 130A (MIG) / 20 - 130A (ARC) / 20 - 130A (TIG)	50 - 160A (MIG) / 20 - 160A (ARC) / 20 - 160A (TIG)
MIG DUTY CYCLE 15%	130A	160A
OUTPUT POWER SETTINGS	Infinitely Variable	Infinitely Variable
APPROX. WELDING THICKNESS	0.8 - 6.4mm (mild steel)	0.8 - 6.4mm (mild steel)
WIRE SIZE	0.6 - 1.0mm	0.6 - 1.0mm
WIRE SPOOL SIZE	0.7kg	0.7kg / 5kg
WEIGHT	6.3kg	8.7kg
ADDITIONAL FEATURES	3-IN-1 FUNCTION	3-IN-1 FUNCTION
EX. VAT	£249.99	£299.99
INC. VAT	£299.99	£359.99

NOTE: Gas bottles not included

TO PLACE AN ORDER: www.sip-group.com



PURE · SYNERGIC

ALLOWS FOR AUTONOMOUS CONTROL OF THE WELDING PARAMETERS FOR EASE OF OPERATION

SIP WELDMATE® AUTOPLUS MIG/ARC/TIG SYNERGIC WELDERS

FEATURES A VARIETY OF POWERFUL OUTPUT CAPABILITIES TO MEET DEMANDING APPLICATIONS IN AUTOMOTIVE ENVIRONMENTS

IDEAL FOR AUTOMOTIVE AND SHEET METAL APPLICATIONS

SUPERIOR ARC STABILITY FOR GREATER WELDING CONTROL AND REDUCED SPATTER

SYNERGIC CONTROL FOR SINGLE DIAL ADJUSTMENT OF WELDING VOLTAGE & WIRE FEED SPEED

CAST METAL WIRE FEEDER, SUITABLE FOR MAX. 5KG WIRE REEL

SOFT TOUCH CONTROL PANEL - SELECT BETWEEN WELDING PROCESS, GAS TYPE AND WIRE SIZE

TWIN LED'S FOR WELDING OUTPUT DISPLAY

SUPPLIED WITH 3MTR MIG WELDING TORCH



05739



PURE · SYNERGIC



05740



PURE · SYNERGIC



CLEAR EASY-TO-READ CONTROL PANEL

SIP WELDMATE® AUTOPLUS 180A MIG/ARC/TIG SYNERGIC with SIP 3 Tier Welding Cart

- Premium SIP AUTOPLUS 180A Synergic welder
- Cart holds larger size bottles up to 50kg
- Sturdy all-metal construction



Item No: 05739CART

£379.99 EX.VAT

£455.99 INC.VAT

SIP WELDMATE® AUTOPLUS 180A MIG/ARC/TIG SYNERGIC with SIP Large Cylinder Welding Trolley

- Premium SIP AUTOPLUS 180A Synergic welder
- Trolley holds larger size bottles up to 99kg
- Heavy-duty wheel-mounted trolley with all steel design



Item No: 05739TROLLEY

£399.99 EX.VAT

£479.99 INC.VAT

SIP WELDMATE® AUTOPLUS 200A MIG/ARC/TIG SYNERGIC with SIP 3 Tier Welding Cart

- Premium SIP AUTOPLUS 200A Synergic welder
- Cart holds larger size bottles up to 50kg
- Sturdy all-metal construction



Item No: 05740CART

£429.99 EX.VAT

£515.99 INC.VAT

SIP WELDMATE® AUTOPLUS 200A MIG/ARC/TIG SYNERGIC with SIP Large Cylinder Welding Trolley

- Premium SIP AUTOPLUS 200A Synergic welder
- Trolley holds larger size bottles up to 99kg
- Heavy-duty wheel-mounted trolley with all steel design



Item No: 05740TROLLEY

£449.99 EX.VAT

£539.99 INC.VAT

TIG TORCH
AVAILABLE - 05035
FOR USE WITH 05739, 05740



Item No: 05035

£59.99 EX.VAT

£71.99 INC.VAT

Item No	05739	05740
MODEL	SIP WELDMATE® AUTOPLUS 180A MIG/ARC/TIG SYNERGIC	SIP WELDMATE® AUTOPLUS 200A MIG/ARC/TIG SYNERGIC
INPUT SUPPLY	230v	230v
OUTPUT CURRENT	50 - 180A (MIG) / 20 - 180A (ARC) / 20 - 180A (TIG)	50 - 200A (MIG) / 20 - 200A (ARC) / 20 - 200A (TIG)
MIG DUTY CYCLE 15%	180A	200A
OUTPUT POWER SETTINGS	Infinitely Variable	Infinitely Variable
APPROX. WELDING THICKNESS	0.8 - 6.4mm (mild steel)	0.8 - 6.4mm (mild steel)
WIRE SIZE	0.6 - 1.0mm	0.6 - 1.0mm
WIRE SPOOL SIZE	0.7kg / 5kg	0.7kg / 5kg
WEIGHT	8.7kg	8.7kg
ADDITIONAL FEATURES	3-IN-1 FUNCTION	3-IN-1 FUNCTION
EX. VAT	£349.99	£399.99
INC. VAT	£419.99	£479.99

NOTE: Gas bottles not included



NEW RANGE

SIP WELDING

SIP WELDMATE® PRO MIG/ARC/TIG SYNERGIC WELDERS



PURE SYNERGIC

ALLOWS FOR AUTONOMOUS CONTROL OF THE WELDING PARAMETERS FOR EASE OF OPERATION

DELIVERS HIGH OUTPUTS AND DUTY CYCLES FOR LONGER CONTINUOUS WELDING FOR OUTSTANDING DURABILITY AND FUNCTIONALITY TO MEET THE NEEDS OF PROFESSIONAL WORKSHOP ENVIRONMENTS.

ADAPTABLE MACHINES OFFER GREATER PRECISION AND WELDING CONTROL WITH A VARIETY OF MATERIAL TYPES.

05734:
SYNERGIC CONTROL FOR SINGLE DIAL ADJUSTMENT OF WELDING VOLTAGE & WIRE FEED SPEED
IN-BUILT ALUMINIUM MIG WELDING PROGRAM
SOFT TOUCH CONTROL PANEL - SELECT BETWEEN WELDING PROCESS, GAS TYPE AND WIRE SIZE
HOLDS UP TO 5KG WIRE SPOOL SIZE
CAST METAL WIRE FEEDER



CLEAR EASY-TO-READ CONTROL PANEL



05734



05735:
SYNERGIC CONTROL FOR SINGLE DIAL ADJUSTMENT OF WELDING VOLTAGE & WIRE FEED SPEED
SINGLE & DUAL MIG PULSE
LCD SCREEN TO SELECT WELDING PROCESSES AND PULSE SETTINGS
PROGRAMMABLE JOB MEMORY
HOLDS UP TO 15KG WIRE SPOOL SIZE
CAST METAL WIRE FEEDER
SUPPLIED WITH 3MTR WELDING TORCH
SUPPLIED WITH ADDITIONAL TORCH LINER FOR ALUMINIUM MIG WELDING



05735



4-IN-1 FUNCTION WELDER

SIP WELDMATE® PRO 200A MIG/ARC/TIG SYNERGIC with SIP Large Cylinder Welding Trolley

- Premium SIP WELDMATE PRO 200A Synergic welder
- Trolley holds larger size bottles up to 99kg
- Heavy-duty wheel-mounted trolley with all steel design



Item No: 05734TROLLEY

£579.99 EX.VAT

£695.99 INC.VAT

TIG TORCH AVAILABLE - 05035

FOR USE WITH 05734, 05735



Item No: 05035

£59.99 EX.VAT

£71.99 INC.VAT



PULSE SYNERGIC

ADVANCED MIG WELDING
SPRAY TRANSFER



CLEAR EASY-TO-READ CONTROL PANEL

Item No	05734	05735
MODEL	SIP WELDMATE® PRO 200A MIG/ARC/TIG SYNERGIC	SIP WELDMATE® PRO 200A MIG/ARC/TIG PULSE SYNERGIC
INPUT SUPPLY	230v (16A)	230v (16A)
OUTPUT CURRENT	50 - 200A (MIG) / 20 - 200A (ARC) / 20 - 200A (TIG)	50 - 200A (MIG) / 30 - 170A (Pulsed MIG) / 20 - 180A (ARC) / 20 - 180A (TIG)
MIG DUTY CYCLE 30%	200A @ 20°C	200A / 170A (Pulsed) @ 20°C
OUTPUT POWER SETTINGS	Infinitely Variable	Infinitely Variable
APPROX. WELDING THICKNESS	0.8 - 6.4mm (mild steel) / 3.2 - 7.9 (aluminium)	0.8 - 6.4mm (mild steel) / 3.2 - 7.9 (aluminium)
WIRE SIZE	0.6 - 1.0mm	0.6 - 1.2mm
WIRE SPOOL SIZE	0.7kg / 5kg	5kg / 15kg
WEIGHT	11.7kg	14.8kg
ADDITIONAL FEATURES	3-IN-1 FUNCTION	4-IN-1 FUNCTION
EX. VAT	£499.99	£599.99
INC. VAT	£599.99	£719.99

NOTE: Gas bottles not included

TO PLACE AN ORDER: www.sip-group.com



SIP AUTOPLUS TRANSFORMER MIG WELDERS

FEATURES:

- PROFESSIONAL 3MTR MIG WELDING TORCH
- GAS HOSE
- EARTH LEAD
- 2-ROLL WIRE FEED
- WHEEL-MOUNTED DESIGN WITH INTEGRATED BOTTLE CARRIER

IDEAL FOR AUTOMOTIVE, AGRICULTURAL & WORKSHOP USE

30A LOW CURRENT PERFORMANCE FOR WELDING CAR BODY PANELS

DUAL PURPOSE GAS/GASLESS OPERATION

WHEEL-MOUNTED



TAKE 1/2 & FULL SIZE GAS BOTTLES

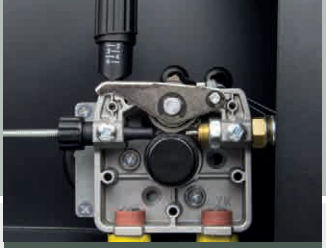

ALL-METAL 2-ROLL WIRE FEED

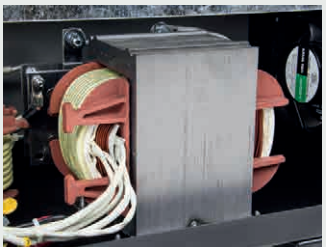

HEAVY-DUTY TRANSFORMER



TO PLACE AN ORDER: 01509 500500

Item No	05718	05720	05722
MODEL	SIP AUTOPLUS 180ST - MIG	SIP AUTOPLUS 210ST - MIG	SIP AUTOPLUS 250ST - MIG
INPUT SUPPLY	230v	230v	230v
OUTPUT CURRENT	30 - 180A (peak)	30 - 210A (peak)	30 - 250A (peak)
OPEN CIRCUIT VOLTAGE	15.5 - 21.25v	15.5 - 22.75v	15.5 - 24.5v
OUTPUT POWER SETTINGS	6	6	6
APPROX. WELDING THICKNESS	0.8 - 7mm (mild steel)	0.8 - 9mm (mild steel)	0.8 - 10mm (mild steel)
WIRE SIZE	0.6 - 1mm	0.6 - 1mm	0.6 - 1mm
WIRE SPOOL SIZE	5kg / 15kg	5kg / 15kg	5kg / 15kg
WEIGHT	51.5kg	52kg	53.5kg
ADDITIONAL FEATURES	HEAVY-DUTY TRANSFORMER PROFESSIONAL EURO CONNECTION MIG TORCH ALL-METAL 2-ROLL WIRE FEED TURBO FAN-COOLED FOR INCREASED DUTY CYCLES WHEEL-MOUNTED	HEAVY-DUTY TRANSFORMER PROFESSIONAL EURO CONNECTION MIG TORCH ALL-METAL 2-ROLL WIRE FEED TURBO FAN-COOLED FOR INCREASED DUTY CYCLES WHEEL-MOUNTED	HEAVY-DUTY TRANSFORMER PROFESSIONAL EURO CONNECTION MIG TORCH ALL-METAL 2-ROLL WIRE FEED TURBO FAN-COOLED FOR INCREASED DUTY CYCLES WHEEL-MOUNTED
EX. VAT	£419.99	£519.99	£799.99
INC. VAT	£503.99	£623.99	£959.99

SIP PROFESSIONAL DUAL-FUNCTION INVERTER MIG WELDERS

Our collection of industrial MIG/MMA (ARC) Inverters boast IGBT technology, 4-roll wire feeds, 2T/4T trigger modes and infinitely variable power output, allowing for more versatility and durability in a number of trade, professional, and industrial applications.

60% DUTY CYCLE
@ MAX. AMPS
FOR LONGER WELD TIMES
HIGHER THAN OTHER BRANDS



Item No	05769	05772	05777	05776
MODEL	SIP HG2400 COMPACT MIG INVERTER	SIP HG3000 COMPACT MIG INVERTER	SIP HG3000S MIG INVERTER SEPARATE WIRE FEED	SIP HG4500 MIG INVERTER SEPARATE WIRE FEED
INPUT SUPPLY	230v	230v	230v	400v
MIG OUTPUT CURRENT	50 - 200A	50 - 250A	50 - 250A	40 - 350A
MIG DUTY CYCLE @ 60%	200A	250A	250A	350A
WIRE SIZE	0.8 - 1mm	0.8 - 1mm	0.8 - 1mm	0.8 - 1.2mm
ARC OUTPUT CURRENT	30 - 200A	30 - 200A	30 - 200A	30 - 350A
ELECTRODE SIZE	1.6 - 4mm	1.6 - 6mm	1.6 - 6mm	1.6 - 6mm
WEIGHT	48.1kg	48.1kg	53kg	71kg
WHAT'S IN THE BOX?	MB25 TORCH 3mtr, 3mtr earth lead, gas hose, 0.6 & 1mm contact tips	MB25 TORCH 3mtr, 3mtr earth lead, gas hose, 0.6 & 1mm contact tips	MB25 TORCH 3mtr, 3mtr earth lead, 5mtr interconnecting harness, 1x set 0.8/1mm feed rolls, 1x set 1.2/1.6mm feed rolls	MB36 TORCH 4mtr, 3mtr earth lead, 5mtr interconnecting harness, 1x set 0.8/1mm feed rolls, 1x set 1.2/1.6mm feed rolls, 1x 1.2mm contact tip
EX. VAT	£899.99	£999.99	£1299.99	£1999.99
INC. VAT	£1079.99	£1199.99	£1559.99	£2399.99

SIP SPOT WELDERS

Ideal for a range of automotive and sheet metal applications, SIP's range of hand held and stationery spot welders are ideal for both light-duty and heavy-duty uses.



SIP PROFESSIONAL HAND-HELD SPOT WELDERS

2 hand-held compact and portable spot welders, fitted with heavy-duty transformers. Manufactured in Italy, and are suitable for automotive and light sheet metal applications, especially where access is limited. Both welders are supplied with quality arms and electrodes.

25287 comes equipped with a manual welding time adjuster

25288 is equipped with an electronic control for welding power, welding time and continuous/pulse functions



25287



16A 230v



25288



32A 230v

Item No	25287	25288
MODEL	SIP PROFESSIONAL SPOTWELD 21	SIP PROFESSIONAL SPOTWELD 22
INPUT SUPPLY	230v (16A)	230v (25A)
MAX. INPUT POWER	1.2kW	2.3kW
MAX. WELDING CURRENT	3800A	6300A
MAX. WELDING CAPACITY	1+1mm (mild steel) / 6+6mm Ø	2+2mm (mild steel) / 6+6mm Ø
OPERATION	Weld timer	Electronic welding current & welding time
ARM / ELECTRODE LENGTH	120mm / 100mm (top), 50mm (bottom)	120mm / 100mm (top), 50mm (bottom)
WEIGHT	10.6kg	11.1kg
ADDITIONAL FEATURES	MANUAL WELDING CURRENT TIME CONTROL FULLY ADJUSTABLE ARM PRESSURE	MICROPROCESSOR CONTROLLED AUTOMATIC WELDING CURRENT TIME CONTROL - DEPENDING ON THICKNESS FULLY ADJUSTABLE TIP PRESSURE
EX. VAT	£779.99	£899.99
INC. VAT	£935.99	£1079.99

SIP PROFESSIONAL COLUMN SPOT WELDER

SIP CSW25P PNEUMATIC COLUMN SPOT WELDER

- 400v (50A) 1-phase input supply
- 50kVA max / 25kVA @ 50% welding output
- 5+5mm (mild steel plate) / 20+20mm (bar) welding capacity
- 340 - 480mm standard arm length
- 4bar - 8bar air pressure
- Single and double spot welding modes; perfect on oxidised or coated steels
- Digital display for welding current and welding time
- Adjustable air regulator with dampener; controls air pressure and arm descent speed
- 2 stage pneumatic foot pedal; for precise workpiece positioning



- Fitted with high quality water cooling hoses

Item No: 25113
£3999.99 EX.VAT
 £4799.99 INC.VAT

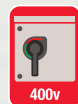

SIP WATER COOLER

For use with SIP CSW25P Column Spot Welder

- 400v input supply
- 8ltr/min water flow rate

Item No: 25125
£849.99 EX.VAT
 £1019.99 INC.VAT





SIP ARC/MMA INVERTER WELDERS

These dual-process inverter welders are portable and lightweight and come complete with electrode holder, welding cable, earth cable and clamp. They are also available with a digital display, which indicates current amperage output.

60% DUTY CYCLE @ MAX. AMPS
FOR LONGER WELD TIMES HIGHER THAN OTHER BRANDS



GENERATOR FRIENDLY

Item No	05705	05707	05711	05715	05732
MODEL	SIP T1400 ARC INVERTER	SIP T1600 ARC INVERTER	SIP HG1401DA INVERTER	SIP HG2001DA INVERTER	SIP HG2600DA INVERTER
INPUT SUPPLY	230v (13A)	230v (16A)	230v (13A)	230v (20A)	230v (22A)
CURRENT OUTPUT	20 - 140A	20 - 160A	20 - 140A	20 - 200A	30 - 250A
DUTY CYCLE	140A @ 20%	160A @ 20%	140A @ 60%	200A @ 60%	250A @ 60%
ELECTRODE DIAMETER	1.6 - 3.2mm 13A 230v	1.6 - 4mm 16A 230v	1.6 - 3.2mm 13A 230v	1.6 - 5mm 32A 230v	1.6 - 5mm 32A 230v
APPROX. WELDING THICKNESS	1.5 - 7mm	1.5 - 8mm	1.5 - 7mm	1.5 - 9mm	1.5 - 10.5mm
DIGITAL DISPLAY	X	X	✓	✓	✓
WEIGHT	3.8kg	3.8kg	4.8kg	6.5kg	9.8kg
ADDITIONAL FEATURES	SCRATCH-TIG FUNCTION THERMAL OVERLOAD PROTECTION ON-DEMAND COOLING GENERATOR FRIENDLY		VOLTAGE REDUCTION DEVICE (VRD) LIFT-TIG FUNCTION THERMAL OVERLOAD PROTECTION GENERATOR FRIENDLY		
EX. VAT	£129.99	£139.99	£189.99	£229.99	£369.99
INC. VAT	£155.29	£167.99	£227.99	£275.99	£443.99

SIP PROFESSIONAL DUAL VOLTAGE ARC/MMA INVERTER WELDER

SIP HG2001DV ARC INVERTER WELDER

- 230v (20A) / 110v (16A) supply
- 25A - 120A output current range (110v)
- 25A - 200A output current range (230v)
- Hot-Start, Arc Force and electrode selection from Rutile / Basic to Cellulosic
- Integrated PFC (Power Factor Correction) reduces mains power consumption and is incorporated in the welders electronic design
- Switchable Voltage Reduction Device (VRD)
- Reliable Lift-TIG torch starting function
- Anti-stick circuitry and easier controls
- Digital display for easy measurement
- Added thermal overload protections
- Generator friendly and super lightweight
- 2mtr electrode lead / 2mtr earth lead



IMPROVED FEATURES

Hot-Start, Arc Force & electrode selection from Rutile / Basic to Cellulosic



110V
AUTO SENSING
230V

Item No: 05717
£249.99 EX.VAT
£299.99 INC.VAT

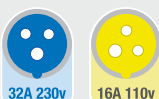

GENERATOR FRIENDLY

SIP WELDING

SIP CORDLESS BATTERY INVERTER WELDER

Portable & accurate welding wherever and whenever you need it

The cordless battery-powered welder brings both portability and performance to locations where mains electricity isn't available. Ideal for agricultural and on-site use.

- Powerful 740Wh battery delivers 180A of welding current
- Lithium-Ion battery fully charged in as little as 90mins
- Welds up to 20x 2.5mm rods @ 85A from a single charge
- Features three welding modes
- Compact and lightweight, weighing ONLY 11.6kg!

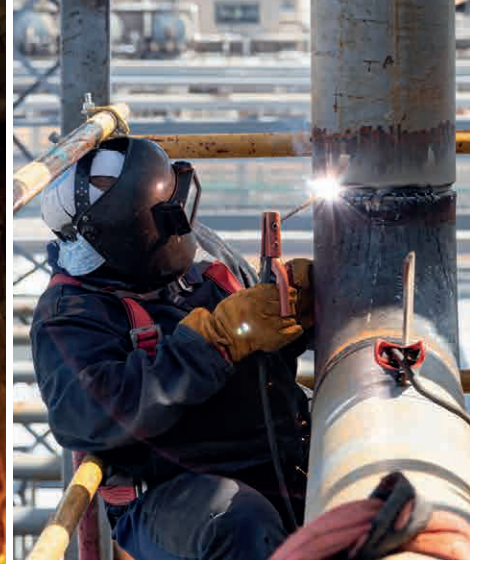

**3 WELDING MODES:
ARC, ARC WITH VRD & LIFT-TIG**



**WEIGHS ONLY
11.6KG**

**SUPPLIED
WITH
HEAVY-DUTY
LEADS**

**PERFECT FOR WELDING
IN REMOTE LOCATIONS,
CONSTRUCTION SITES,
WHERE NO MAINS
ELECTRICITY IS
AVAILABLE**



INTEGRATED CONTROL PANEL PROTECTION VISOR



SUPPLIED WITH FAST CHARGER

Item No	05712		
MODEL	SIP HG1800CBW CORDLESS BATTERY INVERTER WELDER		
BATTERY TYPE	Lithium-Ion		
BATTERY CAPACITY	740Wh		
CHARGER VOLTAGE	230v AC +/- 10%		
CHARGING TIME	1.5hrs		
BATTERY OUTPUT VOLTAGE	74V		
CHARGING CURRENT	8A		
WELDING PROCESS	MMA	TIG	
WELDING CURRENT RANGE	10A - 180A	10A - 150A	
DUTY CYCLE	180A @ 10% / 130A @ 20% / 60A @ 100%		
CONTINUOUS WELDING CAPACITY (ON FULL CHARGE)	20x 2.5mm rods @ 85A	14x 3.2mm rods @ 115A	6x 4mm rods @ 160A
WEIGHT	11.6kg		
EX. VAT	£1599.99		
INC. VAT	£1919.99		

TO PLACE AN ORDER: ☎ 01509 500500

SIP PROFESSIONAL WELDING GENERATORS

KOHLER
IN POWER. SINCE 1920.
3 YEAR ENGINE WARRANTY
PREMIER QUALITY

Product features and benefits:

- **KOHLER® 14hp OHV engine**
- Cast iron cylinder liners
- Splash-fed lubrication system
- Dinse socket connection
- DC Welding: Allows for the use of specialist electrodes for ferrous and non-ferrous metals



Item No	25167
MODEL	SIP P200W-AC
ENGINE	KOHLER® 14 HP OHV
OUTPUT CURRENT	AC
WELDING POWER	60 - 200A
APPROX. WELD THICKNESS	1.5 - 8mm
ELECTRODE SIZE	1.6 - 5mm
GENERATOR OUTPUT	7kVA
FUEL TANK CAPACITY	7.3ltr
APPROX. RUNTIME (FULL LOAD)	2.8hrs
EX. VAT	£1699.99
INC. VAT	£2039.99



Product features and benefits:

- **HONDA™ GX OHV engine**
- Cast iron cylinder liners
- Splash-fed lubrication system
- Dinse socket connection
- DC Welding: Allows for the use of specialist electrodes for ferrous and non-ferrous metals



POWERED by HONDA™
3 year engine warranty



DON'T FORGET...

SIP 1 Litre Advanced Engine Oil



Item No: 02419
£6.99 EX.VAT
£8.39 INC.VAT

Item No	25017	25169	25020	25172
MODEL	SIP P200W-AC	SIP P200W-AC ES	SIP P200W-DC	SIP P200W-DC ES
ENGINE	HONDA™ GX390 OHV	HONDA™ GX390 OHV	HONDA™ GX390 OHV	HONDA™ GX390 OHV
OUTPUT CURRENT	AC	AC	DC	DC
WELDING POWER	60 - 200A	60 - 200A	50 - 200A	50 - 200A
APPROX. WELD THICKNESS	1.5 - 8mm	1.5 - 8mm	1.5 - 8mm	1.5 - 8mm
ELECTRODE SIZE	1.6 - 5mm	1.6 - 5mm	1.6 - 5mm	1.6 - 5mm
GENERATOR OUTPUT	7kVA	7kVA	4kVA	4kVA
FUEL TANK CAPACITY	7.3ltr	7.3ltr	7.3ltr	7.3ltr
APPROX. RUNTIME (FULL LOAD)	2.45hrs	2.45hrs	2.45hrs	2.45hrs
ADDITIONAL FEATURES	-	ELECTRIC START	-	ELECTRIC START
EX. VAT	£1899.99	£2299.99	£2399.99	£2699.99
INC. VAT	£2279.99	£2759.99	£2879.99	£3239.99

Euro 5 Compliant Engines to meet emissions directive for non-road mobile machinery

WELDMATE® TIG/ARC INVERTER WELDERS

Our range of floor fans are mounted on balanced and sturdy steel frames that are fully adjustable to 360° rotation for effective air circulation.

The new oscillating pedestal fan is fixed to a heavy-duty weighted steel base for stability, which has a height adjustable stand. Whilst, the new orbital floor fan can rotate 360° on its horizontal axis and 360° on its vertical axis to create 720° coverage of air circulation.

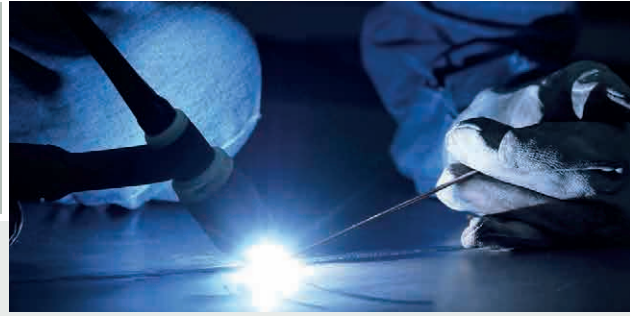

60% DUTY CYCLE
@ MAX. AMPS
FOR LONGER WELD TIMES
HIGHER THAN OTHER BRANDS

LOW OUTPUT
FOR WELDING
THIN MATERIAL



05775



05771



16A 230V

TORCH INCLUDED

Item No	05775	05771
MODEL	SIP HG1801HF DC TIG/ARC	SIP HG2200P TIG/ARC with PULSE
INPUT SUPPLY	230v (16A)	230v (16A)
OUTPUT CURRENT	DC	DC
TIG OUTPUT CURRENT	10 - 160A	5 - 200A
TIG DUTY CYCLE @ 60%	160A	200A
2 TOUCH / 4 TOUCH CONTROL	-	✓
PULSE	-	✓
ARC OUTPUT CURRENT	10 - 140A	20 - 200A
MMA ELECTRODE DIAMETER	1.6 - 3.2mm	1.6 - 4mm
WEIGHT	14.5kg	13kg
ADDITIONAL FEATURES	HF TIG / LIFT ARC TIG / MMA ARC	TIG PULSE FACILITY FOR EASIER PRECISION WELDS SLOPE-UP / SLOPE-DOWN CURRENT FEATURE HF TIG / LIFT ARC TIG / MMA ARC
EX. VAT	£349.99	£419.99
INC. VAT	£419.99	£503.99



SIP WELDMATE® PRO 200A AC/DC TIG/ARC with PULSE INVERTER WELDER



TIG TORCH INCLUDED



SIP FOOT PEDAL CONTROL

- Allows hands-free control of the output current and welding process
- For use with 05795



Item No: 05727
£149.99 EX.VAT
£179.99 INC.VAT



05795PEDAL PRO 200A AC/DC TIG/ARC Welder & 05727 Foot Pedal Control

SAVE £100

Item No: 05795PEDAL
£999.99 EX.VAT
£1199.99 INC.VAT



WELDS ALUMINIUM



Item No	05795
MODEL	SIP WELDMATE® PRO 200A AC/DC TIG/ARC with PULSE
INPUT SUPPLY	230v (16A)
OUTPUT CURRENT	AC/DC
TIG OUTPUT CURRENT	5 - 200A
TIG DUTY CYCLE @ 60%	150A
2 TOUCH / 4 TOUCH CONTROL	✓
PULSE	✓
ARC OUTPUT CURRENT	30 - 160A
MMA ELECTRODE DIAMETER	1.6 - 4mm
WEIGHT	15.9kg
ADDITIONAL FEATURES	4x DIFFERENT AC WAVE FORMS TIG PULSE FACILITY FOR EASIER PRECISION WELDS SLOPE-UP / SLOPE-DOWN CURRENT FEATURE HF TIG / PULSE TIG / MMA ARC
EX. VAT	£949.99
INC. VAT	£1139.99

WELDMATE® PROFESSIONAL INVERTER PLASMA CUTTERS



SIP's range of compact and powerful inverter plasma cutters are designed to accurately and smoothly cut mild steel, stainless steel, aluminium and brass.

Easy to operate and safer than oxy-acetylene processes, our plasma cutters are suitable for automotive, engineering and agricultural environments.

8mm CUT
FROM 13A SUPPLY

★★★★★
NEW
PRODUCT



AIR PRESSURE FILTER REGULATOR



BUILT-IN AIR COMPRESSOR



Item No	05782	05785	05783
MODEL	SIP HG250 INVERTER PLASMA	SIP HG400 INVERTER PLASMA	SIP INT300 PLASMA INTERNAL COMPRESSOR
INPUT SUPPLY	230v (13A)	230v (16A)	230v (16A)
OUTPUT CURRENT	15 - 25A	15 - 40A	10 - 25A
DUTY CYCLE	25A @ 30%	40A @ 60%	25A @ 60%
CUTTING CAPACITY	5.5mm (Quality Cut) 8mm (Severance)	10mm (Quality Cut) 12mm (Severance)	8mm (Quality Cut) 10mm (Severance)
POWER SETTINGS	Infinitely Variable	Infinitely Variable	Infinitely Variable
COMPRESSED AIR PRESSURE	5bar	3 - 6bar	-
AVERAGE AIR CAPACITY	200ltr/min	200ltr/min	-
TORCH TYPE	Contact HF	Contact HF	Pilot ARC Ignition
WEIGHT	6.7kg	9.3kg	17kg
ADDITIONAL FEATURES	LIGHTWEIGHT AIR PRESSURE SENSOR SWITCH 'PARTS IN PLACE' SAFETY CIRCUIT	LIGHTWEIGHT AIR PRESSURE SENSOR SWITCH 'PARTS IN PLACE' SAFETY CIRCUIT	ONE-PERSON LIFT BUILT-IN AIR COMPRESSOR 'PARTS IN PLACE' SAFETY CIRCUIT
EX. VAT	£259.99	£499.99	£799.99
INC. VAT	£311.99	£599.99	£959.99

TO PLACE AN ORDER: ☎ 01509 500500

**TORCH
INCLUDED**



◀ 05787



16A 230v

**TORCH
INCLUDED**



◀ 05789



16A 400v

**25mm CUT
FROM SINGLE PHASE**



16A 230v



◀ 05788

**60% DUTY
CYCLE**

FOR LONGER CUTTING TIMES

Item No	05787	05788	05789
MODEL	SIP HG500 INVERTER PLASMA	SIP HG600 INVERTER PLASMA	SIP HG700 INVERTER PLASMA
INPUT SUPPLY	230v (16A)	230v (16A)	400v (16A)
OUTPUT CURRENT	15 - 50A	15 - 45A	25 - 70A
DUTY CYCLE @ 60%	50A @ 60%	45A @ 60%	70A @ 60%
CUTTING CAPACITY	12mm (Quality Cut) 15mm (Severance)	14mm (Quality Cut) 25mm (Severance)	20mm (Quality Cut) 25mm (Severance)
POWER SETTINGS	Infinitely Variable	Infinitely Variable	Infinitely Variable
COMPRESSED AIR PRESSURE	3 - 6bar	3 - 6bar	3 - 6bar
AVERAGE AIR CAPACITY	200ltr/min	150ltr/min	300ltr/min
TORCH TYPE	Contact HF	Contact HF	Pilot ARC Ignition
WEIGHT	9.3kg	11kg	23kg
ADDITIONAL FEATURES	LIGHTWEIGHT AIR PRESSURE SENSOR SWITCH 'PARTS IN PLACE' SAFETY CIRCUIT	LIGHTWEIGHT AIR PRESSURE SENSOR SWITCH 'PARTS IN PLACE' SAFETY CIRCUIT	ONE-PERSON LIFT AIR PRESSURE SENSOR SWITCH 'PARTS IN PLACE' SAFETY CIRCUIT
EX. VAT	£599.99	£799.99	£999.99
INC. VAT	£719.99	£959.99	£1199.99

SIP MULTI-FUNCTION WELDING HEADSHIELDS

SIP REPLACEMENT HEADSHIELD LENSES
SEE PAGE 61 FOR PRICE

SIP METEOR 2000 ELECTRONIC WELDING HEADSHIELD

- TRUE COLOUR HD LCD Lens technology enhances detail and clarity of the weld
- Fixed 11 SHADE welding setting
- 3/10000 second light-to-dark response time protects eyes from sudden arc
- 2x light sensors
- Solar panel
- Adjustable padded headband for extended comfort
- Lightweight construction - weighs only 0.35kg

Item No: 02819
£24.99 EXVAT
£29.99 INCVAT



SIP METEOR 2185 ELECTRONIC WELDING HEADSHIELD

- TRUE COLOUR HD LCD Lens technology enhances detail and clarity of the weld
- Adjustable Weld / Cut / Grind mode settings: 9 - 13 SHADE for MMA (ARC) / MIG / TIG welding
- 3/10000 second light-to-dark response time protects eyes from sudden arc
- Side-mounted shade dial - convenient shade control
- Automatic darkening filter (ADF) lens - with sensitivity and delay controls
- 2x light sensors
- Solar panel
- Adjustable padded headband for extended comfort
- Lightweight construction - weighs only 0.48kg

Item No: 02883
£38.99 EXVAT
£46.79 INCVAT

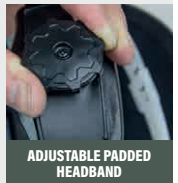
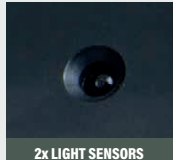

SIP METEOR 2300 ELECTRONIC WELDING HEADSHIELD

- TRUE COLOUR HD LCD Lens technology enhances detail and clarity of the weld
- Adjustable Weld / Cut / Grind mode settings: 9 - 13 SHADE for MMA (ARC) / MIG / TIG welding 5 - 9 SHADE for Plasma cutting 4 SHADE for grinding
- 1/10000sec light-to-dark response time protects eyes from sudden arc
- 4x light sensors
- Large viewing area 100 x 59.5mm
- Test button checks headshield functions correctly
- Solar panel + 2x Lithium CR2450 3v batteries with low power warning light
- Adjustable padded headband for extended comfort
- Lightweight construction - weighs only 0.5kg

Item No: 02884
£54.99 EXVAT
£65.99 INCVAT

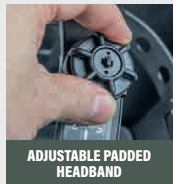
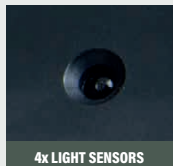
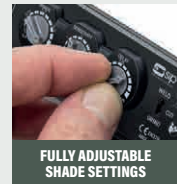
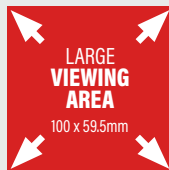

SIP METEOR 2300F ELECTRONIC WELDING HEADSHIELD

- TRUE COLOUR HD LCD Lens technology enhances detail and clarity of the weld
- Striking, distinctive flame design
- Adjustable Weld / Cut / Grind mode settings: 9 - 13 SHADE for MMA (ARC) / MIG / TIG welding 5 - 9 SHADE for Plasma cutting 4 SHADE for grinding
- 1/10000sec light-to-dark response time protects eyes from sudden arc
- 4x light sensors
- Large viewing area 100 x 59.5mm
- Test button checks headshield functions correctly
- Solar panel + 2x Lithium CR2450 3v batteries with low power warning light
- Adjustable padded headband for extended comfort
- Lightweight construction - weighs only 0.5kg

Item No: 02886
£59.99 EXVAT
£71.99 INCVAT

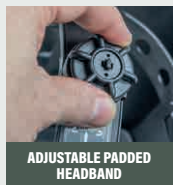
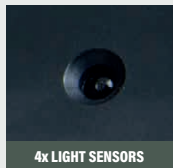
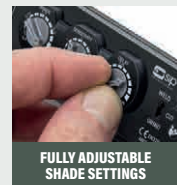
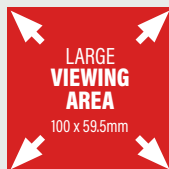

SIP METEOR 8000 PANORAMIC ELECTRONIC WELDING HEADSHIELD

- TRUE COLOUR HD LCD Lens technology enhances detail and clarity of the weld
- PANORAMIC side windows aid peripheral vision (5 Shade)
- 100 x 83mm viewing area
- SHADE RANGE: 9 - 13 SHADE - for MMA (ARC) / MIG / TIG Welding 5 - 9 SHADE - for Plasma Cutting 4 SHADE - for Grinding
- 1/10000sec light-to-dark response time - rapid eye protection from sudden arc
- Side mounted shade dial - adjustable sensitivity and delay controls
- 4x light sensors for fast and stable lens control
- Test butting function
- Solar panel / Lithium CR2450 battery
- Low battery warning light
- Adjustable padded headband for extended comfort
- LIGHTWEIGHT - only 0.65kg

Item No: 02803
£99.99 EXVAT
£119.99 INCVAT

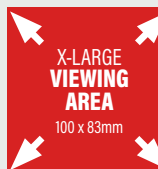

PANORAMIC SIDE WINDOWS (5 SHADE)



SIP ELECTRONIC WELDING HEADSHIELD PAPER with powered air purifying respirator

Complete package: Ready-to-use automatic welding headshield, air blower unit with battery, charger and hoses.

- TRUE COLOUR HD LCD Lens technology enhances detail and clarity of the weld
- MMA (ARC) / MIG / TIG - DIN 9-13 Variable external control automatic welding helmet
- Plasma Shade - DIN 5-9 Variable external control (02815)
- Grinding shade setting - DIN 4
- Lightweight and variable shade welding helmet
- Adjustable padded headband for external comfort
- Powered air purifying air respirator with adjustable belt
- Respirator filtration conforms to: EN12941 (TH2)
- Audible and visual clogged filter alarm on respirator
- Supplied in a sturdy padded carry holdall



FREE CARRY BAG INCLUDED

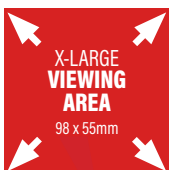
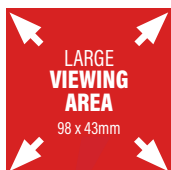

TH2 RESPIRATOR
CONFORMS TO EN12941

Item No	02814	02815
MODEL	SIP ELECTRONIC WELDING HEADSHIELD PAPER WR1000	SIP ELECTRONIC WELDING HEADSHIELD PAPER WR2000
WELDING HEADSHIELD		
VIEWING AREA	98 x 43mm	98 x 55mm
WELDING SHADE	DIN 9-13 Variable External Control	DIN 9-13 Variable External Control
GRIND SHADE	DIN 4	DIN 4
PLASMA SHADE	-	DIN 5-9 Variable External Control
LIGHT to DARK REACTION TIME	1/30000s (0.0003sec)	1/30000sec (0.0003sec)
ARC SENSORS	4	4
WEIGHT	4.6kg	4.6kg
AIR RESPIRATOR		
BATTERY TYPE	Rechargeable Lithium-Ion	Rechargeable Lithium-Ion
AIR FLOW SPEEDS	2 (180 & 200ltr/min)	2 (180 & 200ltr/min)
APPROX. RUNTIME	10hrs (low speed) / 6hrs (high speed)	10hrs (low speed) / 6hrs (high speed)
CHARGE TIME	3hrs	3hrs
FILTRATION LEVEL	TH2	TH2
EX. VAT	£349.99	£389.99
INC. VAT	£419.99	£467.99

The European standard for Powered Air Purifying Respirators is EN12941.

This standard defines 3 classes of performance. These levels are TH1, TH2 and TH3.

The numbers define *level of performance* (*Inward Leakage) & the strengths of the tubes and couplings.

Maximum Inward Leakage for the classifications are:-

TH1 = 10%

TH2 = 2%

TH3 = 0.2%

SIP PAPER Filters are TH2P (Particle Filter).

*Inward Leakage is defined as the combination of contaminated air that leaks through a respirator from various sources, including face seals, valves & gaskets and the penetration through the filter.

Item No	DESCRIPTION	DIMENSIONS	EX. VAT	INC. VAT
WE09-00013	SIP Front Cover Lens True Colour (for 02814, 02815)	123 x 98 mm	£4.39	£5.27
WE09-00017	SIP Inner Cover Lens (for 02814, 02815)	1075 x 58.6mm	£2.79	£3.35
WE09-00028	SIP Main HEPA Filter (for 02814, 02815)	-	£24.99	£29.99
WE09-00029	SIP Pre-filter (for 02814, 02815)	-	£5.49	£6.59

SIP PROFESSIONAL FX WELDING FUME EXTRACTORS



SIP PAPP WELDING HEADSHIELDS
SEE PAGE 59 FOR PRICE



SIP WELDING FUME EXTRACTORS

- Comply with the current regulations for all weldable materials including mild steel
- The welding fumes released are adequately controlled using the SIP FX range of local exhaust ventilators (LEV's)
- Harmful fumes are filtered via the internal filter arrays returning clean air into the working environment
- Welders welding workshops are protected against harmful toxic fumes

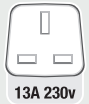

Item No	05800	05802	05812	05806
MODEL	FX PORTABLE WELDING FUME EXTRACTOR	PROFESSIONAL FX-EH MOBILE WELDING FUME EXTRACTOR	PROFESSIONAL FX-WM WALL-MOUNTED WELDING FUME EXTRACTOR	PROFESSIONAL FX-WM WALL-MOUNTED WELDING FUME EXTRACTOR
INPUT SUPPLY	230v	230v	230v	230v
INPUT POWER	1.1kW	1.1kW	1.5kW	1.5kW
POWER CONSUMPTION	4.85A	4.85A	6.5A	6.5A
MAX. FLOW RATE	250m ³ /hr	2500m ³ /hr	2500m ³ /hr	2500m ³ /hr
MAX. SUCTION	110m ³ /hr	1200m ³ /hr	1480m ³ /hr	1480m ³ /hr
FILTRATION	85%	99.5%	99.5%	99.5%
ADJUSTABLE EXTRACTION	Extraction hose	3mtr flexible arm	3mtr flexible arm	2x 3mtr flexible arms
NOISE LEVEL	65dB(A)	73dB(A)	73dB(A)	73dB(A)
WEIGHT	20kg	85kg	100kg	100kg
ADDITIONAL FEATURES	FOR MEDIUM/LOW CONCENTRATIONS OF POLLUTANTS FOR INTERMITTENT OPERATION WITH ADJUSTABLE MOTOR SPEED REGULATION	HIGH PERFORMANCE CENTRIFUGAL EXTRACTION FAN ENCASED IN A SOUNDPROOF COMPARTMENT	HIGH PERFORMANCE CENTRIFUGAL EXTRACTION FAN ENCASED IN A SOUNDPROOF COMPARTMENT SELF INSTALL	HIGH PERFORMANCE CENTRIFUGAL EXTRACTION FAN ENCASED IN A SOUNDPROOF COMPARTMENT SELF INSTALL
EX. VAT	£839.99	£1789.99	£2999.99	£3599.99
INC. VAT	£1007.99	£2147.99	£3599.99	£4319.99

SIP WELDING FUME EXTRACTOR ACCESSORIES

Item No	DESCRIPTION	EX. VAT	INC. VAT
WE08-00003	SIP Anti-spark Metallic Filter (for 05800)	£27.29	£32.75
WE08-00004	SIP Cartridge Filter - 85% efficient (for 05800)	£65.39	£78.47
WE08-00005	SIP Carbon Filter (for 05800)	£116.69	£140.03
WE08-00008	SIP Absolute Filter (for 05802, 05806, 05812)	£282.29	£338.75
WE08-00009	SIP Anti-spark Metallic Filter (for 05802, 05806, 05812)	£36.99	£44.39
WE08-00010	SIP Pre Filter (for 05802, 05806, 05812)	£32.69	£39.23

TO PLACE AN ORDER: ☎ 01509 500500

SIP REPLACEMENT WELDING HEADSHIELD LENSES

Item No	DESCRIPTION	DIMENSIONS
02862	SIP Front Cover Lens True Colour (for 02883)	118 x 95mm
02895	SIP Back Cover Lens (for 02883)	103 x 47mm
02897	SIP Front Cover Lens (for 02884, 02886)	134 x 114mm
02898	SIP Back Cover Lens (for 02884, 02886)	105 x 66mm
02804	SIP Front Cover Lens (for 02803)	338.9 x 155.7mm
02805	SIP Back Cover Lens (for 02803)	103.5 x 88.6mm

EX. VAT	INC. VAT
£4.39	£5.27
£3.29	£3.95
£3.29	£3.95
£3.29	£3.95
£5.49	£6.59
£4.39	£5.27



SIP MIG TORCHES



Heavy-duty welding torches for use with MIG welders

Item No	DESCRIPTION	EX. VAT	INC. VAT
05502	SIP 15 3mtr Euro MIG Welding Torch	£81.79	£98.15
05505	SIP 25 3mtr Euro MIG Welding Torch	£111.19	£133.43
05510	SIP 25 4mtr Euro MIG Welding Torch	£115.59	£138.71
05515	SIP 36 4mtr Euro MIG Welding Torch	£179.89	£215.87

SIP ELECTRODE HOLDERS



Durable solutions suitable for demanding welding applications

Item No	DESCRIPTION	EX. VAT	INC. VAT
02744	SIP 400A Twist Electrode Holder	£10.89	£13.07
02715	SIP 300A Electrode Holder	£10.89	£13.07
02700	SIP 200A Electrode Holder	£7.69	£9.23

SIP TIG TORCHES



Heavy-duty welding torches for use with TIG welders

Item No	DESCRIPTION	EX. VAT	INC. VAT
05029	SIP 17V Small Dinse TIG Welding Torch	£59.99	£71.99
05035	SIP 17V Large Dinse TIG Welding Torch	£59.99	£71.99
05018	SIP 17 4mtr 3-Pin TIG Welding Torch	£92.69	£111.23
05015	SIP 26 4mtr 5-Pin TIG Welding Torch	£110.09	£132.11
05016	SIP 26 4mtr 3-Pin TIG Welding Torch	£92.69	£111.23

SIP PLASMA TORCHES



Hard-wearing plasma torches for accurate and reliable metal cutting

Item No	DESCRIPTION	EX. VAT	INC. VAT
WE04-00177	SIP P80 Plasma Torch Pilot ARC	£179.99	£215.99
05123	SIP 6mtr P80 Plasma Torch without Connector	£128.69	£154.43

SIP EARTH CLAMPS



High-quality steel clamps for demanding welding applications

Item No	DESCRIPTION	EX. VAT	INC. VAT
02743	SIP 400A Steel Earth Clamp	£8.79	£10.55
02750	SIP 600A Cast Brass Earth Clamp	£37.09	£44.51

SIP WELDERS ANGLE CLAMPS

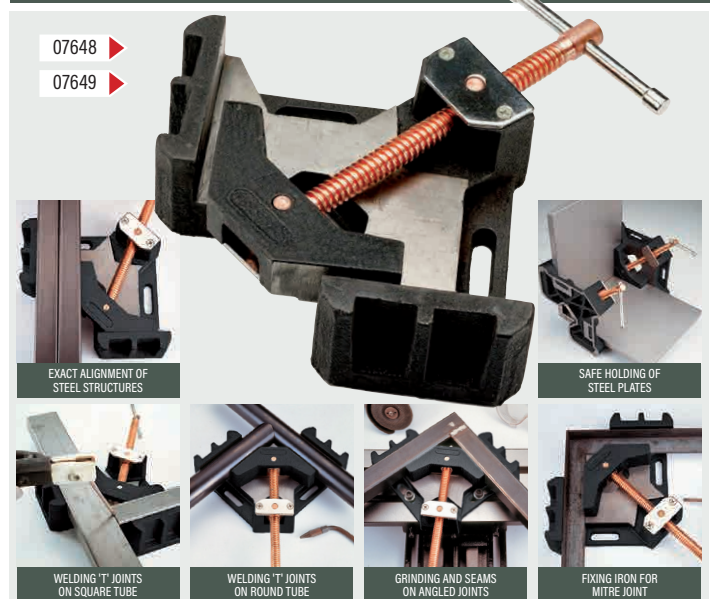

Item No	DESCRIPTION	EX. VAT	INC. VAT
07648	SIP 6" 274 Welders Angle Clamp	£59.99	£71.99
07649	SIP 9" 275 Welders Angle Clamp	£74.99	£89.99

SIP WELDING ACCESSORIES

SIP WELDING HEADSHIELDS
SEE PAGE 58-59 FOR RANGE



SIP ARC/MMA WELDING ELECTRODES - DIY DISPLAY PACKS



High quality general purpose electrodes for all ARC/MMA machines
Suitable for mild steel (E6013)

Item No	DESCRIPTION	EX. VAT	INC. VAT
02691	SIP 10x 1.6mm	£5.49	£6.59
02692	SIP 10x 2.0mm	£5.49	£6.59
02693	SIP 10x 2.5mm	£5.49	£6.59
02694	SIP 10x 3.25mm	£5.49	£6.59
02689	SIP 6x 1.6mm, 5x 2mm, 4x 2.5mm	£6.59	£7.91

SIP ARC/MMA WELDING ELECTRODES - BULK BOXES



High quality general purpose ARC/MMA electrodes
Suitable for mild steel (E6013)

Item No	DESCRIPTION	EX. VAT	INC. VAT
02769	SIP 1.6mm, Mild Steel (6013) 2kg	£9.99	£11.99
02921	SIP 2.0mm, Mild Steel (6013) 2.5kg	£8.99	£10.79
02777	SIP 2.5mm, Mild Steel (6013) 5kg	£16.99	£20.39
02778	SIP 3.25mm, Mild Steel (6013) 5kg	£15.99	£19.19
02779	SIP 4.0mm, Mild Steel (6013) 5kg	£16.99	£20.39

SIP MIG WELDING TORCH TIPS & SHROUDS



Item No	DESCRIPTION	EX. VAT	INC. VAT
04040	SIP 0.6mm Tips M5 (Pack of 5)	£3.69	£4.43
04045	SIP 0.8mm Tips M5 (Pack of 5)	£3.69	£4.43
04144	SIP 0.8mm Tips M6 (Pack of 5)	£5.49	£6.59
04142	SIP MB15 Conical MIG Shrouds (2 Per Pack)	£5.99	£7.19
04035	SIP Migmate MIG Shrouds (2 Per Card)	£4.99	£5.99
04058	SIP MIG Torch Starter Kit (S/Liner, 2x Shroud, 5x Tips)	£10.89	£13.07

SIP MIG WELDING WIRE



Premium quality MIG wire for gas / gasless welding applications

Item No	DESCRIPTION	EX. VAT	INC. VAT
04000	SIP Display 0.6mm Mild Steel 0.7kg	£5.89	£7.07
02666	SIP 0.6mm Mild Steel 5kg	£23.99	£28.79
02668	SIP 0.6mm Mild Steel 15kg	£69.99	£83.99
04005	SIP 0.8mm Mild Steel 0.7kg	£5.59	£6.71
02669	SIP 0.8mm Mild Steel 5kg	£18.99	£22.79
02671	SIP 0.8mm Mild Steel 15kg	£44.99	£53.99
02681	SIP 1.0mm Mild Steel 15kg	£43.59	£52.31
04055	SIP Display 0.8mm Flux Cored Mini 0.227kg	£7.69	£9.23
04010	SIP Display 0.8mm Flux Cored 0.45kg	£8.19	£9.83
02678	SIP 0.8mm Flux Cored for Gasless 0.90kg	£13.99	£16.79
02706	SIP 0.8mm Flux Cored for Gasless 4.5kg	£54.39	£65.27
04060	SIP Display 0.8mm Aluminium 0.5kg	£12.59	£15.11
04065	SIP Display 0.8mm Stainless Steel 0.7kg	£17.99	£21.59

SIP MIG WELDING GAS & GAS BOTTLE REGULATOR



Disposable gas bottles for MIG gas welding applications
CO₂ for MIG mild steel welding
Argon / CO₂ for MIG mild steel welding - gives better finish
Pure Argon for all TIG welding applications
Pure Argon for MIG aluminium welding

Item No	DESCRIPTION	EX. VAT	INC. VAT
04015	SIP Display CO ₂ Gas 390g	£18.49	£22.19
04020	SIP Display Argon/CO ₂ Gas 390g	£17.99	£21.59
04025	SIP Display Argon Gas 390g	£18.59	£22.31
04012	SIP Display CO ₂ Gas 600g	£19.99	£23.99
04030	SIP Gas Regulator for disposable bottles	£19.99	£23.99

SIP WELDING PPE



Item No	DESCRIPTION	EX. VAT	INC. VAT
02846	SIP Flip-Top Welding Headshield	£11.99	£14.39
04156	SIP Welding Gauntlets	£4.49	£5.39
04146	SIP Deluxe Welding Gauntlets	£9.79	£11.75
04148	SIP TIG Welding Gauntlets	£8.79	£10.55
04151	SIP Welding Apron (24" x 36")	£8.79	£10.55
25112	SIP Leather Welding Gloves and Apron	£34.99	£41.99

TO PLACE AN ORDER: 01509 500500

SIP WELDING BLANKET & CURTAIN



Item No	DESCRIPTION	EX. VAT	INC. VAT
04161	SIP Welding Blanket (2 x 1m)	£41.39	£49.67
04166	SIP Welding Curtain (6' x 6')	£38.19	£45.83
04167A	SIP Welding Curtain & Frame Package	£96.89	£116.27

SIP MIG PLIERS

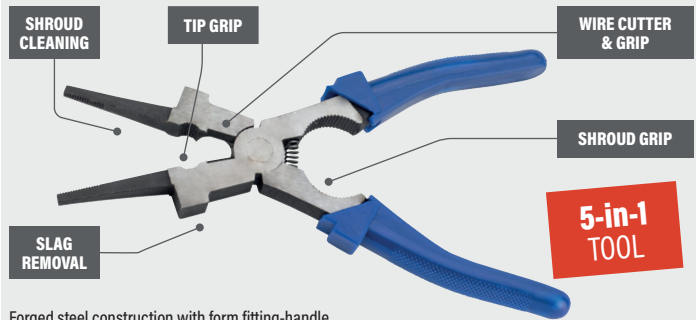

Forged steel construction with form fitting-handle
Used for nozzle and tip installation, wire cutting, nozzle cleaning and spatter removal

Item No	DESCRIPTION	EX. VAT	INC. VAT
04168	SIP MIG Pliers	£14.19	£17.03

SIP GENERAL WELDING ACCESSORIES



Item No	DESCRIPTION	EX. VAT	INC. VAT
09550	SIP Magnetic Holder M Model holds up to 50lbs / 23kg	£9.79	£11.75
09552	SIP Magnetic Holder L Model holds up to 75lbs / 34kg	£10.89	£13.07
09530	SIP Welding Clamps (Set of 3)	£20.69	£24.83
02820	SIP Advanced Anti Spatter Spray - 400ml	£4.39	£5.27
02709	SIP Spring Handle Metal Chipping Hammer	£4.39	£5.27

SIP MAGNETIC WELDING EARTH CLAMP



Item No	DESCRIPTION	EX. VAT	INC. VAT
04157	SIP Magnetic Earth Clamp 400A	£10.89	£13.07

SIP MAGNETIC WELDING TORCH HOLDERS



Ultra magnetic welding torch holders with strong gripping power to any ferrous object
Ideal for storing MIG / TIG torches whilst preparing the area to be welded

Item No	DESCRIPTION	EX. VAT	INC. VAT
04158	SIP Magnetic Welding Torch Holder MIG	£7.69	£9.23
04159	SIP Magnetic Welding Torch Holder TIG	£7.69	£9.23

SIP WELDING TABLE



Designed for welding and cutting applications.
Features an expanded metal grate inside frame and pan for collecting slag and sparks.
Includes a ground tab for ground clamp, MIG torch holder and U-hook for storing cables, helmet etc.
Size: 528 x 944 x 700mm
Net weight: 16kg

Item No	DESCRIPTION	EX. VAT	INC. VAT
05709	SIP Welding Table	£109.99	£131.99

SIP WELDING WIRE BRUSHES



Item No	DESCRIPTION	EX. VAT	INC. VAT
04173	SIP Wire Brush - 3 Row (Mild Steel)	£1.89	£2.27
04174	SIP Wire Brush - 4 Row (Mild Steel)	£2.29	£2.75
04169	SIP Wire Brush - 3 Row (Stainless Steel)	£2.79	£3.35
04171	SIP Wire Brush - 4 Row (Stainless Steel)	£2.99	£3.59
04176	SIP Converging Wire Brush	£10.99	£13.19

SIP WOOD BANDSAWS

SIP PREMIUM 10" WOOD BANDSAW

- Solid cast steel table for accurate cutting - 350 x 330mm
- 0° - 45° table tilt
- Steel frame construction
- 230v (13A) input supply
- Powerful 370w (0.5hp) motor
- 245mm throat width
- 100mm max. cutting height
- 1750mm blade length
- 6 - 13mm blade width
- 1 speed - 13mtr/sec
- Fully adjustable blade tensioning
- Integrated rip fence and bearing guide
- Mitre gauge
- 100mm dust extraction outlet
- Magnetic NVR switch

SIP PROFESSIONAL 12" WOOD BANDSAW

- Solid cast steel table for accurate cutting - 400 x 500mm
- 0° - 45° table tilt
- Steel frame construction
- 230v (13A) input supply
- Powerful 750w (1hp) motor
- 300mm throat width
- 175mm max. cutting height
- 2240mm blade length
- 6 - 15mm blade width
- 2 speed - 6mtr/sec, 12mtr/sec
- Fully adjustable blade tensioning
- Integrated rip fence and bearing guide
- Mitre gauge
- 100mm dust extraction outlet
- Magnetic NVR switch



TO PLACE AN ORDER: ☎ 01509 500500

Item No: 01475
£349.99 EX.VAT
 £419.99 INC.VAT



Item No: 01477
£699.99 EX.VAT
 £839.99 INC.VAT



FOR REPLACEMENT BLADES - SEE PAGE 76



SIP PROFESSIONAL 14" WOOD BANDSAW

Heavy-Duty

- Large 535 x 435mm solid cast steel table
- 0° - 45° table tilt
- 230v (13A) input supply
- Powerful 1500w (2hp) motor
- 355mm throat width
- 235mm max. cutting height
- 2750mm blade length
- 6 - 25mm blade width
- 2 speeds - 8mtr/sec, 14mtr/sec
- Rack & pinion rise and fall
- Fully adjustable blade tensioning
- Integrated rip fence with bearing guide
- Heavy-duty cast mitre fence
- Cast mitre gauge
- Dust extraction
- Magnetic NVR switch
- Stand included



Item No: 01444
£1199.99 EX.VAT
£1439.99 INC.VAT



NVR SWITCH

STAND INCLUDED

RIP FENCE WITH BEARING GUIDE

SIP PROFESSIONAL 16" WOOD BANDSAW

Heavy-Duty

- Large 535 x 435mm solid cast steel table
- 0° - 45° table tilt
- 230v (13A) input supply
- Powerful 2200w (2hp) motor
- 405mm throat width
- 254mm max. cutting height
- 3345mm blade length
- 10 - 25mm blade width
- 2 speeds - 7mtr/sec, 14mtr/sec
- Rack & pinion rise and fall
- Fully adjustable blade tensioning
- Integrated rip fence with bearing guide
- Heavy-duty cast mitre fence
- Cast mitre gauge
- Dust extraction
- Magnetic NVR switch



Item No: 01445
£1639.99 EX.VAT
£1967.99 INC.VAT



NVR SWITCH

RIP FENCE WITH BEARING GUIDE

SIP MITRE, TABLE & SCROLL SAWS

SIP 10" SLIDING COMPOUND MITRE SAW WITH LASER

- Input voltage: 230v (13A) • Heavy-duty, high torque 2kW (2.7hp) motor
- Belt-drive for powerful and smooth performance • Sliding action for extended range
- Laser for greater cutting accuracy
- Adjustable depth stop tenoning & trenching tasks
- Dust collection bag
- No load blade speed: 5500rpm
- High quality Ø 254mm Ø x 30mm bore x 40TCT saw blade
- Mitre Table Angles: -45° / 0° / +45°
- Bevel Angles: Up to 45° (Left & Right)
- Cutting Capacity:
 - Straight Cut at 0°x 0°: 340mm x 80mm
 - Mitre Cut at 45°x 0°: 240mm x 80mm
 - Bevel Cut at 0°x 45°: 340mm x 50mm
 - Compound Mitre Cut at 45°x 45°: 240mm x 50mm



Item No: 01511
£179.99 EX.VAT
 £215.99 INC.VAT

2000W MOTOR
LASER GUIDANCE



BLADE INCLUDED

SIP 12" SLIDING COMPOUND MITRE SAW WITH LASER

- Input voltage: 230v (13A) • Heavy-duty, high torque 1.8kW (2.4hp) motor
- Belt-drive for powerful and smooth performance • Sliding action for extended range
- Laser for greater cutting accuracy
- Adjustable depth stop tenoning & trenching tasks
- Dust collection bag
- No load blade speed: 3800rpm
- High quality Ø 305mm x 30mm bore x 40TCT saw blade
- Mitre Table Angles: -45° / 0° / +45°
- Bevel Angles: Up to 45° (Left & Right)
- Cutting Capacity:
 - Straight Cut at 0°x 0°: 330mm x 105mm
 - Mitre Cut at 45°x 0°: 230mm x 105mm
 - Left Bevel Cut at 0°x 45°: 330mm x 60mm
 - Right Bevel Cut at 0°x 45°: 230mm x 33mm
 - Left Compound Mitre Cut at 45°x 45°: 230mm x 60mm
 - Right Compound Mitre Cut at 45°x 45°: 230mm x 33mm



Item No: 01505
£249.99 EX.VAT
 £299.99 INC.VAT

2000W MOTOR
LASER GUIDANCE



BLADE INCLUDED

SIP 10" TABLE SAW WITH STAND

- 230v (13A) input supply
- Powerful 1.8kW (2.4hp) motor
- Large versatile cutting capacities:
 - 65mm depth of cut @ 45°
 - 85mm depth of cut @ 90°
- 5000rpm no-load blade speed
- 2x side extensions, 940 x 640mm
- 0° to 45° full blade tilting capability
- 'Quick-Lock' length rip fence
- Mitre guide and push stick included
- Built-in 35mm dust extraction port
- Rise and fall tilting arbor
- Integrated NVR switch



Item No: 01986
£179.99 EX.VAT
 £215.99 INC.VAT



BLADE INCLUDED

SIP 16" SCROLL SAW WITH FLEXI-DRIVE SHAFT

- 230v (13A) input supply • 90w motor • Flexible work light • Flexi-Drive tool
- 0° - 45° tilting cast aluminium table • 406mm throat size
- 550 - 1600spm blade speed
- 15mm blade stroke
- 64 piece grinding / polishing / sanding kit included



Item No: 01947
£169.99 EX.VAT
 £203.99 INC.VAT



BLADE INCLUDED

TO PLACE AN ORDER: 01509 500500

FOR REPLACEMENT BLADES - SEE PAGE 76



SIP 2-in-1 Table Saw with Integrated Dust Extractor

Eliminate sawdust from indoor wood cutting tasks. An innovation for professionals working in domestic or commercial premises, the 2-in-1 Table Saw features an integrated dust extractor which collects up to 95% of the sawdust it creates.

An extendable cutting table and adjustable tilting saw blade add greater versatility to the job, whilst a compact all-in-one design allows the saw to be easily transported between work sites.

- Integrated Dust Extractor
- Versatile Cutting Capacity
- Extendable Cutting Table
- Outstanding Portability



Integrated dust extractor with easy-change collection bag



Extendable table:
550mm x 475mm (standard)
550mm x 650mm (extended)



Compact all-in-one unit can be easily moved between jobs - WEIGHS ONLY 16KG



Item No: 01513
£299.99 EX.VAT
£359.99 INC.VAT

2 MOTORS

1200W (SAW)
1000W (EXTRACTOR)

TCT BLADE

5300rpm

CUTTING CAPACITY

40mm @ 90° **24mm @ 45°**



- **INDOOR WOOD CUTTING!**
- **CLEAN WORK AREA!**
- **LESS MESS!**



- Skirting boards
- Architrave
- Panelling
- Floor boards
- Wood, MDF composites & laminates

SIP PROFESSIONAL COMPACT 10" CAST IRON TABLE SAW

Compact design for smaller footprint in the workshop, helping to minimise lost floor space

- Sliding carriage (sold separately) offers added stability and woodcutting accuracy
- Extendable table area 635mm x 1000mm
- Cast iron table, adjustable blade height & tilt, mitre setting, fence & extraction port
- Table size: 635mm(D) x 420mm(W)
(with extension table) 635mm(D) x 1000mm(W)
- Saw blade: bore size 254mm, Ø30mm
- Powerful 2200W (3hp) 230v induction motor
- Blade speed 4000rpm
- Max. depth of cut 80mm @ 90°
- Max. depth of cut 65mm @ 45°
- Cutting width (with extension table) 750mm
- Table Dimension 1450 x 1000 x 1000mm
- Net Weight (including floor stand) 107kg



10" TCT BLADE SUPPLIED AS STANDARD



QUICK ADJUST RIP FENCE WITH 'QUICK-LOCK' MICRO ADJUST



100MM Ø DUST EXTRACTION OUTLET



SIP SLIDING CARRIAGE for Compact 10" Cast Iron Table Saw



NEW PRODUCT

NEW PRODUCT

BLADE INCLUDED

Item No: 01480
£899.99 EXVAT
 £1079.99 INCVAT



13A 230v

PERFECT PARTNERS

Item No: 01481
£119.99 EXVAT
 £143.59 INCVAT

TO PLACE AN ORDER: 01509 500500

SIP WHEEL KIT

- Designed to position and manoeuvre woodworking machines around the workshop
- Ideal for environments requiring added workspace flexibility



Item No: 06920
£99.99 EXVAT
 £119.99 INCVAT



• Compatible with: 01332, 01444, 01445, 01446 & 01456

FOR REPLACEMENT BLADES - SEE PAGE 76

OUR NO-NONSENSE, AFFORDABLE
& RELIABLE WOOD SAWS SEE PAGE 139



SIP TABLE SAWS

SIP PROFESSIONAL 10" CAST IRON TABLE SAW

- 230v (16A) input supply
- Powerful 2200w (3hp) induction motor
- Accurate 0° - 45° arbour with blade lock
- Fine adjustment saw blade rise and fall with lock
- Maximum depth of cut: 53mm @ 45° / 75mm @ 90°
- 560 x 800mm standard table size (1170 x 800mm with supplied extensions)
- 10" TCT blade supplied as standard
- 'T' slotted heavy-duty cast mitre guide and push stick included
- Quick adjust rip fence with 'Quick-lock' micro adjust
- 100mm Ø dust extraction outlet
- Cabinet stand included



BLADE INCLUDED



Item No: 01332
£1599.99 EX.VAT
£1919.99 INC.VAT



**DON'T FORGET!
ROLLER STANDS**
SEE PAGE 73
FOR PRICES



SIP SLIDING CARRIAGE for 10" Cast Iron Table Saw

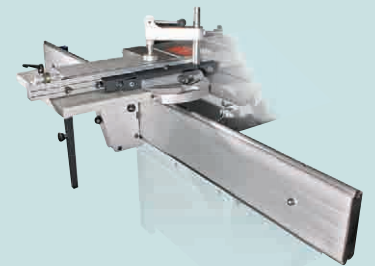

Item No: 01495
£632.99 EX.VAT
£759.59 INC.VAT



SIP PROFESSIONAL 12" CAST IRON TABLE SAW

- 230v (16A) input supply
- Powerful 3000w (4hp) induction motor
- Accurate 0° - 45° arbour with blade lock
- Fine adjustment saw blade rise and fall with lock
- Maximum depth of cut: 80mm @ 45° / 100mm @ 90°
- 600 x 800mm standard table size (1500 x 800mm with supplied extensions)
- 12" TCT blade supplied as standard
- 'T' slotted heavy-duty cast mitre guide and push stick included
- Quick adjust rip fence with 'Quick-lock' micro adjust
- 100mm Ø dust extraction outlet
- Cabinet stand included

Item No: 01448
REAR EXTENSION TABLE
FOR 12" TABLE SAW
£87.19 EX.VAT
£104.63 INC.VAT

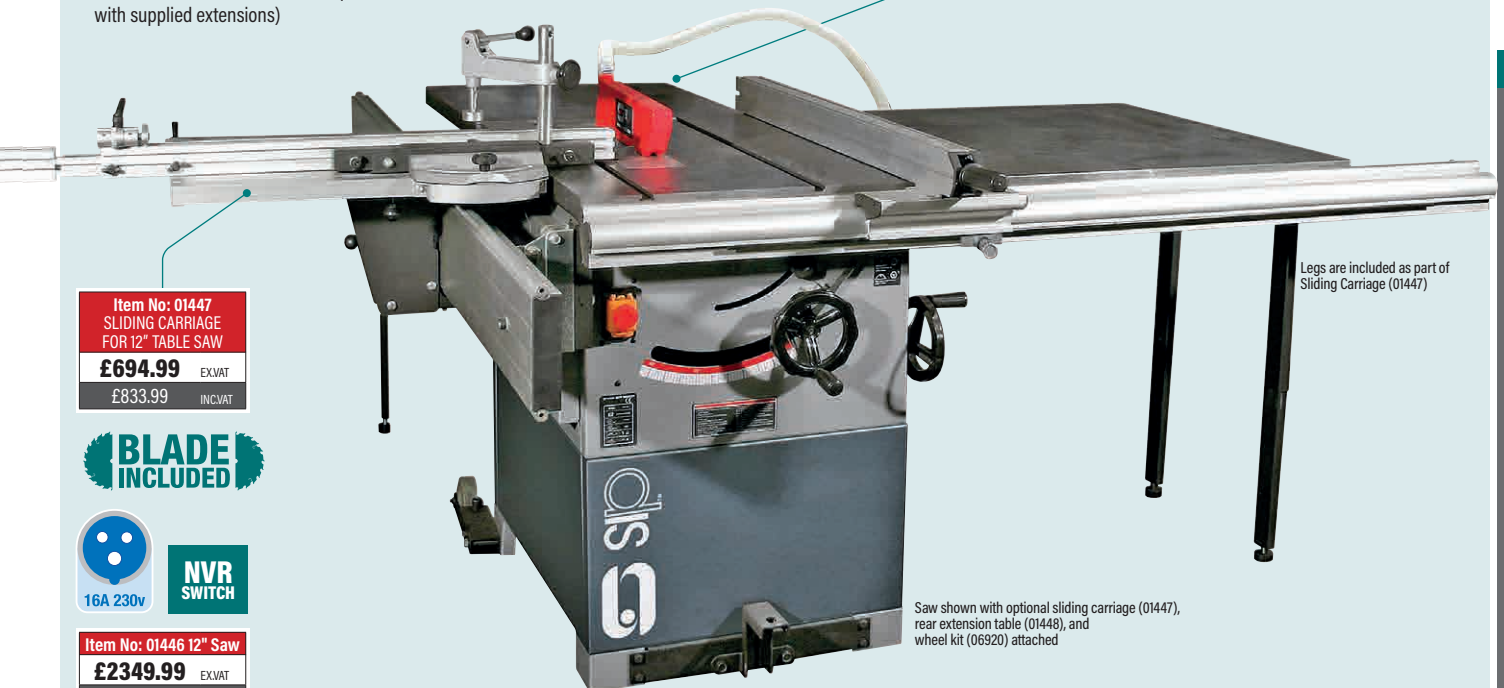

Item No: 01447
SLIDING CARRIAGE
FOR 12" TABLE SAW
£694.99 EX.VAT
£833.99 INC.VAT

BLADE INCLUDED



Item No: 01446 12" Saw
£2349.99 EX.VAT
£2819.99 INC.VAT

Legs are included as part of Sliding Carriage (01447)

Saw shown with optional sliding carriage (01447), rear extension table (01448), and wheel kit (06920) attached

FOR REPLACEMENT BLADES - SEE PAGE 76

TO PLACE AN ORDER: www.sip-group.com

SIP WOOD LATHES

SIP 14" x 40" STARTER WOOD LATHE WITH 3PC CHISEL KIT

- 230v (13A) input supply
- 370w (0.5hp) motor
- 350mm maximum turning diameter
- 1000mm maximum turning between centres
- 720 - 2150rpm variable speed
- 3/4" x 16TPI spindle thread size
- Revolving centre
- Thermal cut-off switch

Item No: 01458
£179.99 EX.VAT
 £215.99 INC.VAT



SIP CAST IRON WOOD LATHES

- Robust heavy-duty cast iron lathe beds, headstock and tailstocks
- Revolving centres
- Digital read-outs for accurate speed display



NVR SWITCH

01936



DIGITAL DISPLAY FOR SPEED READ-OUT (01936)



DIGITAL DISPLAY FOR SPEED READ-OUT (01938, 01940)

01938



01940



YouTube



SCAN HERE

ITEM No.	01936	01938	01940
MODEL	SIP VARIABLE SPEED CAST IRON MUDI WOOD LATHE	SIP 12" x 36" SWIVEL HEAD WOOD LATHE	SIP 14" x 43" SWIVEL HEAD WOOD LATHE
INPUT SUPPLY	230v (13A)	230v (13A)	230v (13A)
MOTOR POWER	550w (0.75hp)	550w (0.75hp)	750w (1hp)
SPEED RANGE	500 - 3500rpm (variable)	500 - 2000rpm (variable)	500 - 2000rpm (variable)
MAX. DISTANCE BETWEEN CENTRES	432mm	900mm	1100mm
MAX. TURNING DIAMETER	305mm	300mm	350mm
SPINDLE THREAD SIZE	3/4" x 16TPI	3/4" x 16TPI	3/4" x 16TPI
WEIGHT	32kg	77kg	130kg
ADDITIONAL FEATURES	-	-	Cast iron leg stand included
EX. VAT	£399.99	£549.99	£799.99
INC. VAT	£479.99	£659.99	£959.99

FOR LATHE ACCESSORIES - SEE PAGE 76

SIP 8" x 5" PLANER THICKNESSER

- 230v (13A) input supply
- Powerful 1500w (2hp) motor
- 9000rpm cutter block speed
- 204mm planer width
- 740mm table length
- 2.5mm max. cutting depth
- 90 - 135° fence tilt

- THICKENING:**
- 5 - 120mm timber size thickening
 - 204mm max. timber width
 - 6.4mtr/min feed speed
 - 2mm max. depth of cut
 - Fitted with dust extraction port



13A 230v

Item No: 01557
£309.99 EXVAT
£371.99 INCVAT

NVR SWITCH

SIP 10" x 5" PLANER THICKNESSER

- 230v (13A) input supply
- Powerful 1500w (2hp) motor
- 9000rpm cutter block speed
- 252mm planer width
- 920mm table length
- 2.5mm max. cutting depth
- 90 - 135° fence tilt

- THICKENING:**
- 5 - 120mm timber size thickening
 - 252mm max. timber width
 - 6.4mtr/min feed speed
 - 2mm max. depth of cut
 - Fitted with dust extraction port



13A 230v

Item No: 01558
£399.99 EXVAT
£479.99 INCVAT

NVR SWITCH

SIP 12" DISC SANDER WITH MANUAL BRAKE

- 230v (13A) input supply
- Powerful 800w S1 motor
- 305mm (12") disc size
- 1490rpm disc speed
- Grit 60 sanding disc

- 410 x 175 x 25mm table working area
- 0 - 45° downwards table tilt
- 0 - 60° (both directions) mitre gauge
- Integrated dust collection / extraction port

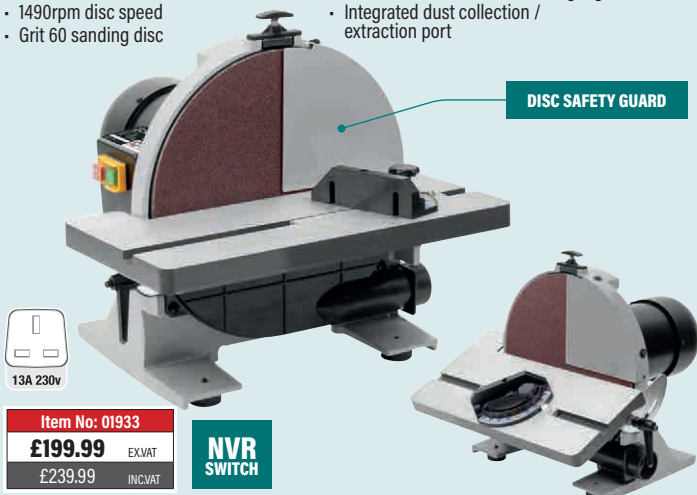

DISC SAFETY GUARD



13A 230v

Item No: 01933
£199.99 EXVAT
£239.99 INCVAT

NVR SWITCH

SIP 4" x 8" BELT/DISC SANDER

- 230v (13A) input supply
- Powerful 500w motor
- 0° to 45° disc workable tilt
- 0° to 90° belt tilt
- 100 x 914mm sanding belt, 200mm sanding disc
- 2850rpm disc speed
- 550mtr/min belt speed
- Easy-to-use belt tension control lever for fast belt changes

- Supplied with 2 large aluminium adjustable sanding tables and one mitre guide for increased accuracy
- Dust extraction/collection



Item No: 01946
£209.99 EXVAT
£251.99 INCVAT



13A 230v

NVR SWITCH

BUILT-IN DUST EXTRACTION

SIP 6" x 10" BELT/DISC SANDER

- 230v (13A) input supply
- 750w (1hp) brushless motor
- 150 x 1220mm (6" x 48") belt size
- 250mm (10") disc size
- 0° to 45° disc workable tilt
- 0° to 90° belt tilt

- 2980rpm disc speed
- 470mtr/min belt speed
- Supplied with 2 adjustable sanding tables and mitre guide



90°

Item No: 01927
£349.99 EXVAT
£419.99 INCVAT



13A 230v

LEG STAND INCLUDED

NVR SWITCH

SIP SPINDLE MOULDER & MORTICERS

SIP PROFESSIONAL TILTING SPINDLE MOULDER

- 230v (16A) input supply
- Powerful 2.8kW (3.75hp) induction motor
- Spindle tilt: -10° to +30°
- Table pre-drilled to accept power feed unit
- Low speed for use with the sanding bobbin (included)
- 900mm table height
- 4 spindle speeds; 1800, 3000, 6000 and 9000rpm
- 200mm table aperture



-10° TO +30° SPINDLE TILT

Item No: 01456
£1999.99 EX.VAT
 £2399.99 INC.VAT



Spindle Moulder shown with optional sliding carriage (01457)



SIP SLIDING CARRIAGE for Tilting Spindle Moulder

- Large 500 x 480mm sliding table - Ball bearing sliding table movement
- High-quality adjustable mitre and cross fence with built-in work clamp

WHEEL KIT AVAILABLE
 SEE PAGE 68
 FOR PRICE



Item No: 01457
£499.99 EX.VAT
 £599.99 INC.VAT

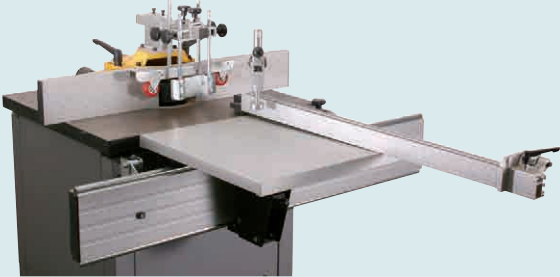

SIP BENCH MORTICERS

SIP BENCH MORTICER

- 230v (13A) input supply
- 370w (0.5hp) motor
- 1400rpm speed
- 76mm chisel stroke
- 6 - 12mm (1/4" - 1/2") chisel capacity
- 340 x 150mm table size
- 65mm max. chisel to fence
- 3/4" standard bush size
- Cast iron construction



Item No: 01942
£279.99 EX.VAT
 £335.99 INC.VAT



SIP BENCH MORTICER with Sliding Table

- 230v (13A) input supply
- 370w (0.5hp) motor
- 1400rpm speed
- 130mm chisel stroke
- 6 - 16mm (1/4" - 5/8") chisel capacity
- Table movement: 100mm (lateral) / 40mm (longitudinal)
- 50mm max. spindle to fence
- 100mm max. chisel to table
- 80mm max. clamping width
- Cast iron construction



Item No: 01944
£429.99 EX.VAT
 £515.99 INC.VAT



SIP HEAVY-DUTY BENCH MORTICER with Cabinet

- 230v (13A) input supply
- 750w (1hp) motor
- 1400rpm speed
- 210mm chisel stroke
- 6 - 26mm (1/4" - 1") chisel capacity
- Table movement: 170mm (lateral) / 145mm (longitudinal)
- 140mm max. spindle to fence
- 210mm max. chisel to table
- 400 x 150mm table size
- Cabinet stand included



Item No: 01950
£869.99 EX.VAT
 £1043.99 INC.VAT



TO PLACE AN ORDER: 01509 500500

SIP SINGLE ROLLER STAND

- 80kg load capacity
- Precision-made, fully adjustable single roller
- 400mm roller length
- 700 - 1100mm adjustable height

80KG CAPACITY



Item No: 01379
£49.99 EX.VAT
 £59.99 INC.VAT

SIP ADJUSTABLE V-TYPE ROLLER BALL STAND

- 100kg load capacity
- 2 sets of 4 rollers
- Each roller set tilts and locks at 45° independently
- 700 - 1150mm fully adjustable height



100KG CAPACITY



Item No: 01383
£59.99 EX.VAT
 £71.99 INC.VAT

SIP HEAVY-DUTY 5 ROLLER STAND

- 100kg load capacity
- 5 rollers
- 680 to 1150mm fully adjustable height
- 57mm roller diameter
- 450mm roller length

100KG CAPACITY



Item No: 01381
£109.99 EX.VAT
 £131.99 INC.VAT

SIP BEECH WORKBENCH

- High-quality beech construction
- (L)1350mm x (W)620mm x (H)900mm
- Integrated waist-high storage drawer
- 2 x integral wooden vices
- 4x metal work piece holding pegs
- Low-level, full-length storage shelf



Item No: 01443
£179.99 EX.VAT
 £215.99 INC.VAT

SIP PROFESSIONAL HARDWOOD 4-DRAWER WORKBENCH

- Sturdy and durable hardwood construction
- (L)1640mm x (W)500mm x (H)820mm
- 4x storage drawers
- Side-mounted wooden vice
- 4x metal work piece holding pegs
- Low-level, full-length storage shelf

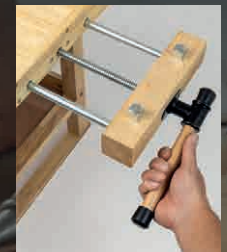

NEW PRODUCT

Item No: 01460
£259.99 EX.VAT
 £311.99 INC.VAT

SIP DUST COLLECTORS

0.5 MICRON MODEL



01923

COMPLETE WITH FREE 5-PIECE COLLECTOR ADAPTOR

Worth £23.99!

YouTube
SCAN HERE

5 MICRON FILTRATION MODELS



01963

PORTABLE & WALL MOUNTABLE

LOW NOISE

01968

FLOOR-CLEANING ATTACHMENT



01969

FLOOR-CLEANING ATTACHMENT



01954

TWIN INLET ADAPTOR



01956

TRIPLE INLET ADAPTOR

TO PLACE AN ORDER: 01509 500500

Item No	01923	01963	01968	01969	01954	01956
MODEL	SIP 50LTR DUST & CHIP COLLECTOR	SIP 1HP PORTABLE SINGLE BAG DUST COLLECTOR	SIP SINGLE BAG DUST COLLECTOR c/w FLOOR ATTACHMENT	SIP 1HP SINGLE BAG DUST COLLECTOR c/w FLOOR ATTACHMENT	SIP 2HP SINGLE BAG DUST COLLECTOR	SIP 3HP DOUBLE BAG DUST COLLECTOR
INPUT SUPPLY	230v (13A)	230v (13A)	230v (13A)	230v (13A)	230v (13A)	230v (16A)
MOTOR TYPE	1100w (brushed)	750w (brushless induction)	550w (brushless induction)	750w (brushless induction)	1500w (brushless induction)	2200w (brushless induction)
MAX. AIR FLOW VOLUME	183m ³ /hr	850m ³ /hr	1200m ³ /hr	850m ³ /hr	2500m ³ /hr	3900m ³ /hr
FAN DIAMETER	80mm	230mm	230mm	230mm	300mm	305mm
CAPACITY	50ltr	56ltr	57ltr	57ltr	153ltr	2x 153ltr
INLET DIAMETER	100mm	100mm	100mm	100mm	1x 125mm or 2x 100mm	1x 150mm or 3x 100mm
FILTRATION	0.5 micron (cartridge)	5 micron (bag)	5 micron (bag)	5 micron (bag)	5 micron (bag)	2x 5 micron (bag)
ADDITIONAL FEATURES	5 PIECE ADAPTOR 2mtr HOSE CARTRIDGE & PAPER BAG FILTRATION	COMPACT WHEEL-MOUNTED CHASSIS 4X CASTOR WHEELS	WHEEL-MOUNTED FLOOR VACUUM ATTACHMENT HOSE EXTRACTION	WHEEL-MOUNTED FLOOR VACUUM ATTACHMENT HOSE EXTRACTION	WHEEL-MOUNTED TWIN INLET ADAPTOR RUN TWO MACHINES WITH ONE COLLECTOR	WHEEL-MOUNTED TRIPLE INLET ADAPTOR RUN THREE MACHINES WITH ONE COLLECTOR
EX. VAT	£109.99	£189.99	£199.99	£229.99	£299.99	£399.99
INC. VAT	£131.99	£227.99	£239.99	£275.99	£359.99	£479.99

FOR CONSUMABLES - SEE PAGE 76

NEW PRODUCT

SIP RETRACTABLE ELECTIC CABLE REEL SEE PAGE 103



SIP DUST COLLECTORS

1 MICRON HIGH FILTRATION MODELS



01964

WALL MOUNTED

HIGH FILTRATION



01990

HIGH FILTRATION PACKAGE

FLOOR-CLEANING ATTACHMENT



01992

HIGH FILTRATION PACKAGE

TWIN INLET ADAPTOR



01994

HIGH FILTRATION PACKAGE

TRIPLE INLET ADAPTOR



SIP 1 Micron Filtration Cartridges

- High filtration (1 micron) for fine particles including MDF
- Prevent particles above 1 micron
- Manual filter shaker/cleaner
- WD02-01385 for use with 01964.
- 62605 for use with 01969, 01990
- 62606 for use with 01954, 01956, 01992, 01994.

Item No: 62605

£139.99 EX.VAT
£167.99 INC.VAT

Item No: WD02-01385

£129.99 EX.VAT
£155.99 INC.VAT

Item No: 62606

£199.99 EX.VAT
£239.99 INC.VAT

Item No	01964	01990	01992	01994
MODEL	SIP 1HP WALL-MOUNTED SINGLE CARTRIDGE DUST COLLECTOR	SIP 1HP SINGLE CARTRIDGE DUST COLLECTOR c/w FLOOR ATTACHMENT PACKAGE	SIP 2HP SINGLE CARTRIDGE DUST COLLECTOR PACKAGE	SIP 3HP DOUBLE CARTRIDGE DUST COLLECTOR PACKAGE
INPUT SUPPLY	230v (13A)	230v (13A)	230v (13A)	230v (16A)
MOTOR TYPE	750w (brushless induction)	750w (brushless induction)	1500w (brushless induction)	2200w (brushless induction)
MAX. AIR FLOW VOLUME	850m ³ /hr	850m ³ /hr	2500m ³ /hr	3900m ³ /hr
FAN DIAMETER	230mm	230mm	300mm	305mm
CAPACITY	56ltr	57ltr	153ltr	2x 153ltr
INLET DIAMETER	100mm	100mm	1x 125mm or 2x 100mm	1x 150mm or 3x 100mm
FILTRATION	1 micron (cartridge)	c/w 1 micron (cartridge 62605)	c/w 1 micron (cartridge 62606)	c/w 2x 1 micron (cartridges 62606)
ADDITIONAL FEATURES	WALL-MOUNTED HIGH FILTRATION FOR FINE PARTICLES INCLUDING MDF	WHEEL-MOUNTED HIGH FILTRATION FOR FINE PARTICLES INCLUDING MDF FLOOR VACUUM ATTACHMENT	WHEEL-MOUNTED HIGH FILTRATION FOR FINE PARTICLES INCLUDING MDF TWIN INLET ADAPTOR RUN TWO MACHINES WITH ONE COLLECTOR	WHEEL-MOUNTED HIGH FILTRATION FOR FINE PARTICLES INCLUDING MDF TRIPLE INLET ADAPTOR RUN THREE MACHINES WITH ONE COLLECTOR
EX. VAT	£319.99	£349.99	£489.99	£729.99
INC. VAT	£383.99	£419.99	£587.99	£875.99

FOR CONSUMABLES - SEE PAGE 76

TO PLACE AN ORDER: www.sip-group.com

SIP WOODWORKING - REPLACEMENT BLADES

Item No	DESCRIPTION	EX. VAT	INC. VAT
06925	SIP 2750mm x 6mm x 0.25mm 6TPI Bandsaw Blade (for 01444)	£33.79	£40.55
06927	SIP 2750mm x 19mm x 0.80mm 6TPI Bandsaw Blade (for 01444)	£31.59	£37.91
06930	SIP 2750mm x 12mm x 0.65mm 6TPI Bandsaw Blade (for 01444)	£19.99	£23.99
06931	SIP 2750mm x 25mm x 0.9mm 4TPI Bandsaw Blade (for 01444)	£35.99	£43.19
06932	SIP 3345mm x 13mm x 0.65mm 6TPI Bandsaw Blade (for 01445)	£22.89	£27.47
06933	SIP 3345mm x 25mm x 0.9mm 4TPI Bandsaw Blade (for 01445)	£42.49	£50.99
09430	SIP 3345mm x 20mm x 0.8mm 6TPI Bandsaw Blade (for 01445)	£40.39	£48.47
09440	SIP 1750mm x 6.3mm x 0.35mm 6TPI Bandsaw Blade (for 01475)	£11.99	£14.39
09442	SIP 1750mm x 9.5mm x 0.35mm 6TPI Bandsaw Blade (for 01475)	£12.99	£15.59
09444	SIP 1750mm x 12.7mm x 0.52mm 4TPI Bandsaw Blade (for 01475)	£15.29	£18.35
09446	SIP 2240mm x 6.3mm x 0.35mm 6TPI Bandsaw Blade (for 01477)	£13.99	£16.79
09448	SIP 2240mm x 9.5mm x 0.52mm 6TPI Bandsaw Blade (for 01477)	£16.39	£19.67
09450	SIP 2240mm x 12.7mm x 0.52mm 4TPI Bandsaw Blade (for 01477)	£17.49	£20.99
WD07-02070	SIP 165mm x 20mm TCT (50T) Circular Saw Blade (for 01513)	£9.99	£11.99
07773	SIP 254mm x 16mm TCT (40T) Circular Saw Blade (for 01511)	£42.49	£50.99
06184	SIP 254mm x 25.4mm TCT (40T) Circular Saw Blade (for 01332)	£37.09	£44.51
06128	SIP 254mm x 30mm TCT (40T) Circular Saw Blade (for 01930, 01986)	£36.99	£44.39
06123	SIP 254mm x 30mm TCT (40T) Circular Saw Blade (for 01511)	£42.49	£50.99
06138	SIP 254mm x 30mm TCT (36T) Circular Saw Blade (for 01986)	£47.99	£57.59
06122	SIP 305mm x 30mm TCT (40T) Circular Saw Blade (for 01504)	£19.99	£23.99
06156	SIP 315mm x 30mm TCT (30T) Circular Saw Rip Blade (for 01446)	£42.49	£50.99
06158	SIP 315mm x 30mm TCT (40T) Circular Saw Blade (for 01350, 01446)	£57.79	£69.35
06160	SIP 315mm x 30mm TCT (60T) Circular Saw Trim Blade (for 01350, 01446)	£57.79	£69.35
06849	SIP 10pc Assorted Scroll Saw Blades (for 01928, 01947)	£12.99	£15.59
WD01-01445	SIP 6" Planer Blade (for 01557)	£31.59	£37.91
WD01-01581	SIP 8" Planer Blades (for 01558)	£37.99	£45.59

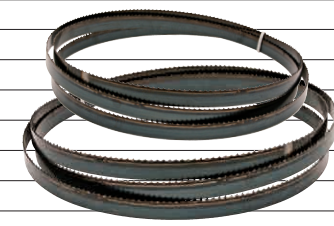

SIP WOODWORKING - GENERAL ACCESSORIES

Item No	DESCRIPTION	EX. VAT	INC. VAT
06851	SIP 2" Chuck 3/4" x 16TPI (for Wood lathes)	£159.99	£191.99
06853	SIP 4" Chuck 3/4" x 16TPI (for Wood lathes)	£85.09	£102.11
06857	SIP 6pc Wood Lathe Chisel Set	£112.29	£134.75
06859	SIP 1" 8TPI x 3/4" 16TPI Chuck Adaptor (for 06851)	£14.19	£17.03
06920	SIP Wheel Kit (for 01444, 01445, 01446, 01456, 01332)	£99.99	£119.99
07740	SIP 4" x 36" Sanding Belt (120 Grit) (for 01362, 01946)	£16.39	£19.67
07742	SIP 4" x 36" Sanding Belt (80 Grit) (for 01946)	£11.99	£14.39
07744	SIP 4" x 36" Sanding Belt (60 Grit) (for 01362, 01946)	£16.39	£19.67
06270	SIP 6" x 48" Sanding Belt (120 Grit) (for 01943, 01331)	£22.89	£27.47
06870	SIP 6" x 48" Sanding Belt (60 Grit) (for 01331, 01943)	£23.99	£28.79
WD01-01692	SIP 6" x 48" Sanding Belt (60 Grit) (for 01927, 01943)	£23.99	£28.79
06868	SIP 6" x 48" Sanding Belt (80 Grit) (for 01331, 01943)	£22.89	£27.47
06839	SIP 8" Medium (P80) Sanding Disc (for 01946)	£11.99	£14.39
06841	SIP 8" Coarse (P60) Sanding Disc (for 01946)	£11.99	£14.39
06843	SIP 8" Fine (P120) Sanding Disc (for 01926, 01946)	£11.99	£14.39
06847	SIP 12" Medium (P80) Sanding Disc (Velcro) (for 01953)	£7.69	£9.23
06860	SIP 10" Sanding Disc (60 Grit) (for 01943)	£8.79	£10.55
06861	SIP 10" Sanding Disc (80 Grit) (for 01943)	£11.99	£14.39
06862	SIP 10" Sanding Disc (120 Grit) (for 01943)	£12.99	£15.59
06896	SIP 12" Sanding Disc (P80) (for 01336)	£10.89	£13.07
01935	SIP 5 Piece Dust Collector Adaptor (for 01923, 01968, 01969, 01954, 01956, 01992, 01994)	£23.99	£28.79
06895	SIP Black Spare Hose 2mtr (for 01923, 01929, 01932)	£23.99	£28.79
62564	SIP Coarse Filter Bag (35micron) (for 01453, 01952)	£24.99	£29.99
62565	SIP Poly Collection Bag (for 01952)	£5.49	£6.59
66371	SIP Plastic Collector Bag (0.153m³) (for 01954, 01956)	£5.49	£6.59
66376	SIP Coarse Filter Cotton Bag (for 01449, 01954, 01956)	£24.99	£29.99
67231	SIP Dust Collector Bag (for 01543)	£15.29	£18.35
62605	SIP 1 Micron Filtration Cartridge (for 01969, 01990)	£139.99	£167.99
62606	SIP 1 Micron Filter Cartridge (for 01954, 01956, 01992, 01994)	£199.99	£239.99
WD02-01385	SIP 1 Micron Filtration Cartridge (for 01964)	£129.99	£155.99
WD01-00665	SIP Dust Bag (for 01511)	£4.39	£5.27



TO PLACE AN ORDER: ☎ 01509 500500



SIP 5 TON HORIZONTAL LOG SPLITTER WITH CAGE

- 230v (13A) input supply · Powerful 2.2kW (3hp) motor · 5 Ton splitting force
- Log capacity: 50 - 250mm diameter, 520mm maximum length
- Integrated handle and large wheels for extra portability
- Ram lock for optimum safety
- Cutting wedge automatically returns to starting position after the log is split



SIP 5 TON LOG SPLITTER STAND

The stand raises the splitter to a workable height when a work bench is not available



Item No: 01972
£35.99 EX.VAT
 £43.19 INC.VAT

REMOVABLE WHEELS FOR USE WITH
OPTIONAL SPLITTER STAND (01972)



Item No: 01976
£299.99 EX.VAT
 £359.99 INC.VAT

3HP (2.2KW) MOTOR

5 TON SPLITTING FORCE

LOG CAPACITY
50 - 250MM Ø /
520MM MAX. LENGTH

NVR
SWITCH



SIP 7 TON VERTICAL LOG SPLITTER

- 230v (13A) input supply
- Powerful 3kW (4hp) motor
- 7 Ton splitting force
- Log capacity: 80 - 300mm diameter, 100 - 550mm maximum length
- Integrated handle and large wheels for extra portability
- Ram lock for optimum safety



Item No: 01978
£549.99 EX.VAT
 £659.99 INC.VAT

4HP (3KW) MOTOR

7 TON SPLITTING FORCE

LOG CAPACITY
80 - 300MM Ø /
100 - 550MM LENGTH

NVR
SWITCH

SIP VERY LOW-NOISE AIR COMPRESSORS



Innovative, low noise, high-quality - QT Air Direct Drive Compressors are engineered with components to reduce the sound generated when in operation, without compromising on air production efficiency.

Essential for use in environments where sound output is a concern, these low maintenance, oil-free compressors operate at just 59dB.



ONLY 59dB

4 TANK SIZES AVAILABLE



- Featuring slow-running, 4-pole brushless induction motors and braided hoses for added durability
- Fan-cooled, twin cylinder motor and pump for efficient air production
- Carry handle and wheel-mounted options for outstanding movability in the work area and between locations
- Anti-vibration mounts support low noise operation
- Pressure switch and air regulator
- Delivers up to 10bar max. pressure



LOW-NOISE PUMPS



TO PLACE AN ORDER: 01509 500500

Item No	05398	04381	04382	04383
MODEL	SIP QT 6ltr OIL-FREE LOW-NOISE COMPRESSOR	SIP QT 24/10 OIL-FREE LOW-NOISE COMPRESSOR	SIP QT 50/10 OIL-FREE LOW-NOISE COMPRESSOR	SIP QT 100/10 OIL-FREE LOW-NOISE COMPRESSOR
INPUT SUPPLY	230v (13A)	230v (13A)	230v (13A)	230v (13A)
MOTOR	0.75HP (0.5kW), 4 POLE, Brushless	1.3HP (1kW), 4 POLE, Brushless	1.3HP (1kW), 4 POLE, Brushless	2x 1.3HP (1kW), 4 POLE, Brushless
AIR RECEIVER	6ltr	24ltr	50ltr	100ltr
PISTON DISPLACEMENT	2CFM	7.3CFM	7.3CFM	14.6CFM
FREE AIR DELIVERY	1.5CFM	5.4CFM	5.4CFM	10.8CFM
MAX. AIR PRESSURE	8bar (116psi)	10bar (145psi)	10bar (145psi)	10bar (145psi)
NOISE LEVEL	59dB(A)	59dB(A)	59dB(A)	59dB(A)
ADDITIONAL FEATURES	TWIN-CYLINDER MOTOR/PUMP UNIT HEAVY-DUTY HANDLE ANTI-VIBRATION RUBBER FEET	TWIN-CYLINDER MOTOR/PUMP UNIT HEAVY-DUTY HANDLE SOLID WHEELS	TWIN-CYLINDER MOTOR/PUMP UNIT HEAVY-DUTY HANDLE SOLID WHEELS	2x TWIN-CYLINDER MOTOR/PUMP UNIT HEAVY-DUTY HANDLE SOLID WHEELS
EX. VAT	£139.99	£199.99	£259.99	£449.99
INC. VAT	£167.99	£239.99	£311.99	£539.99



SIP QT AIR COMPRESSOR RANGE



DURABLE BRAIDED HOSES



EASY-TO-READ PRESSURE GAUGES



BUILT-IN PRESSURE RELEASE VALVE



SOLENOID VALVE FOR ADDED SAFETY

YouTube



SCAN HERE

HEAVY-DUTY HANDLES



SOLID WHEELS FOR EASY MANOEUVRABILITY

05313 SIP QT-AIR BATTERY & MAINS OILLESS COMPRESSOR

INPUT SUPPLY: 18V - 20V (DC) 230V (13A)
 MOTOR: 0.67HP (500W)
 BATTERY TYPE: 20V 4AH (A101-00484)
 BATTERY RUN-TIME: 20MIN (CONTINUOUS)
 BATTERY CHARGE TIME: 7.5HRS
 AIR RECEIVER: 5LTR
 PISTON DISPLACEMENT: 2.8CFM
 FREE AIR DELIVERY: 2.3CFM
 MAX PRESSURE: 9BAR (130PSI)

LCD SCREEN

TWIN CYLINDER HALF SPEED FUNCTION



BATTERY & MAINS OPERATION



1x BATTERY & CHARGER INCLUDED

REPLACEMENT 4AH 20V BATTERY



PORTABLE ONLY 10.8KG!

Item No: 05313
£299.99 EXVAT
 £359.99 INCVAT

Item No: A101-00484
£44.99 EXVAT
 £53.99 INCVAT

SIP PROFESSIONAL BELT-DRIVEN SILENCED PISTON AIR COMPRESSORS

SIP silenced compressors are designed to give you powerful performance but with a fraction of the noise, an excellent addition to any workshop where the installation is required close to the workspace.



06219
05202

100/200 LTR

QUICK ACCESS PANEL; FOR EASY SERVICING AND MAINTENANCE REQUIREMENTS

BELT DRIVE PERFORMANCE WITH LOW NOISE LEVELS

RUBBER-MOUNTED SADDLE

SOUNDPROOF CABINET WITH AIR INTAKE SILENCER

WHEEL-MOUNTED FOR EASY MOVEMENT

16A 230v

MADE IN ITALY

04205
04208

270 LITRE

QUICK ACCESS PANEL; FOR EASY SERVICING AND MAINTENANCE REQUIREMENTS

BELT DRIVE PERFORMANCE WITH LOW NOISE LEVELS

RUBBER-MOUNTED SADDLE

SOUNDPROOF CABINET WITH AIR INTAKE SILENCER

STATIC PLACEMENT FOR MORE PERMANENT SITING

32A 400v

MADE IN ITALY

TO PLACE AN ORDER: 01509 500500

Item No	06219	05202	04205	04208
MODEL	SIP PB3800/3M/100	SIP PB3800/3M/200	SIP NB5.5/270	SIP NB7.5/270
INPUT SUPPLY	230v (16A)	230v (16A)	400v (20A)	400v (20A)
MOTOR	2.2kW (3hp)	2.2kW (3hp)	4kW (5.5hp)	5.5kW (7.5hp)
AIR RECEIVER SIZE	100ltr	200ltr	270ltr	270ltr
PISTON DISPLACEMENT	14CFM	14CFM	23CFM	30CFM
MAX. PRESSURE	145psi (10bar)	145psi (10bar)	160psi (11bar)	145psi (10bar)
SOUND POWER*	69dB(A)	69dB(A)	64dB(A)	64dB(A)
ADDITIONAL FEATURES	HEAVY-DUTY TWIN-CYLINDER PUMP	HEAVY-DUTY TWIN-CYLINDER PUMP	HEAVY-DUTY 2 STAGE PUMP	HEAVY-DUTY 2 STAGE PUMP
EX. VAT	£1299.99	£1499.99	£2599.99	£2799.99
INC. VAT	£1559.99	£1799.99	£3119.99	£3359.99

* All noise calculations comply with Acoustic Determination ISO 3744:2010



SIP WALL MOUNTED AIR COMPRESSOR

Airhub

WALL MOUNTED AIR COMPRESSOR

Low noise wall mounted air compressor that provides a quick and easy solution for a variety of uses around the garage and home workshop.

In a compact, space-saving design the Airhub delivers 8bar of pressure to a 9mtr self-retracting hose reel, whilst the wall-mount bracket offers 180° rotation for added versatility.

Lightweight and easy to install, the AirHub is a convenient, multi-purpose compressed air solution.



Inflating



Blowing



Cleaning



Stapling



Item No: 05323
£179.99 EX.VAT
£215.99 INC.VAT

1.5HP
1.1kW

8 BAR
116PSI

6.30CFM
178ltr/min

9MTR
HOSE

LOW
NOISE

OIL
FREE



SUPPLIED WITH 5 PIECE AIR KIT



QUICK RELEASE COUPLER



SELF-RETRACTING HOSE



COMPACT DESIGN



IDEAL FOR A VARIETY OF USES AROUND THE GARAGE AND HOME WORKSHOP

TO PLACE AN ORDER: www.sip-group.com



SIP AIR COMPRESSORS

Suitable for low pressure & low volume applications
 Compact, durable & lightweight
 Tyre inflation/cleaning/nailing-stapling



05291



LIGHTWEIGHT ONLY 9KG

PERFECT FOR HOUSEHOLDS
& TRAVELLING

OIL-FREE
 CLEAN AIR SUPPLY &
 MAINTENANCE-FREE

6 piece kit includes:
 inflating gun, 3 needles
 (for inflating balls, bicycle
 tyres and small air
 mattresses), inflator gun and
 3mtr rubber hose

BUILT-IN PRESSURE
 REGULATOR ON HOSE



ITALIAN
 DESIGN



05295

**COMPACT
 ULTRA-PORTABLE
 DESIGN**



PERFECT FOR LOW PRESSURE &
 LOW VOLUME APPLICATIONS: INFLATING
 CAR / BIKE TYRES & DUSTER GUNS

EASY-TO-READ GAUGE
 & ERGONOMIC DIAL

QUICK RELEASE COUPLER

OIL-FREE
 CLEAN AIR SUPPLY &
 MAINTENANCE-FREE

Neat rear power cable
 storage hooks



ITALIAN
 DESIGN



06254

06256



INTEGRATED FOOTPLATE



SUITABLE FOR LOW PRESSURE AND
 LOW VOLUME APPLICATIONS -
 TYRE INFLATION AND NAIL GUNS
 110V PERFECT FOR SITE APPLICATIONS

INTEGRATED CONTROL
 PANEL; EASY-TO-READ GAUGE AND
 ERGONOMIC PRESSURE REGULATOR

BUILT WITH AN EFFICIENT
 COOLING SYSTEM; EXTENDED
 LIFE OF THE COMPRESSOR

OIL-FREE
 CLEAN AIR SUPPLY &
 MAINTENANCE-FREE

230v & 110v options available



ITALIAN
 DESIGN



Item No	MODEL	INPUT SUPPLY	MOTOR	AIR RECEIVER SIZE	PISTON DISPLACEMENT	MAX. PRESSURE	WEIGHT	ADDITIONAL FEATURES	EX. VAT	INC. VAT
05291	SIP SUPER BOX	230v (13A)	1.5hp	2ltr	6.4CFM	116psi (8bar)	9kg	OIL-FREE	£164.99	£197.99
05295	SIP 6	230v (13A)	1.5hp	6ltr	6.4CFM	116psi (8bar)	9kg	OIL-FREE	£139.99	£167.99
06254	SIP 0L197/10RC	230v (13A)	1.5hp	10ltr	8CFM	145psi (10bar)	11kg	OIL-FREE	£279.99	£335.99
06256	SIP 0L197/10RC	110v (16A)	1.5hp	10ltr	8CFM	145psi (10bar)	11kg	OIL-FREE	£279.99	£335.99

TO PLACE AN ORDER: ☎ 01509 500500

Ideal for small garages and mobile environments

24 LITRE

06457



OIL-LUBRICATED

EXTERNAL AIR FILTERS; EASY ACCESS FOR GENERAL MAINTENANCE

IDEAL FOR GARAGES, WORKSHOPS AND MOBILE ENVIRONMENTS

BUILT WITH AN EFFICIENT COOLING SYSTEM; EXTENDED LIFE OF THE COMPRESSOR

INTEGRATED PRESSURE SWITCH AND PRESSURE REGULATOR; EASY-TO-READ GAUGE AND ERGONOMIC PRESSURE REGULATOR CONTROL
 QUICK RELEASE COUPLER; EURO-TYPE FITTING



06296

DESIGNED FOR SMALL TRADE APPLICATIONS

OIL-FREE
 CLEAN AIR SUPPLY & MAINTENANCE-FREE

INTEGRATED PRESSURE SWITCH AND PRESSURE REGULATOR; EASY-TO-READ GAUGE AND ERGONOMIC PRESSURE REGULATOR CONTROL
 QUICK RELEASE COUPLER; EURO-TYPE FITTING

KIT INCLUDES: Gravity-fed spray gun, inflator with pressure gauge, degreasing gun, duster gun, nozzles and 5mtr recoil air hose.

06249

DESIGNED FOR SMALL WORKSHOPS AND TRADE APPLICATIONS

OIL-FREE
 CLEAN AIR SUPPLY & MAINTENANCE-FREE



INTEGRATED TOP-MOUNTED CONTROL PANEL WITH EASY-TO-READ GAUGE

QUICK RELEASE COUPLER; EURO TYPE FITTING



AIR KIT INCLUDED



ITALIAN DESIGN



SPACE-SAVING VERTICAL DESIGN



ITALIAN DESIGN



Item No	MODEL	INPUT SUPPLY	MOTOR	AIR RECEIVER SIZE	PISTON DISPLACEMENT	MAX. PRESSURE	NOISE LEVEL	ADDITIONAL FEATURES	EX. VAT	INC. VAT
06457	SIP DD 2HP 24ltr	230v (13A)	2hp	24ltr	8CFM	116psi (8bar)	94.5dB(A)	OIL-LUBRICATED	£119.99	£143.99
06296	SIP 245/25	230v (13A)	2hp	24ltr	8CFM	116psi (8bar)	97dB(A)	OIL-FREE	£179.99	£215.99
06249	SIP V215/25	230v (13A)	1.5hp	24ltr	6.5CFM	116psi (8bar)	97dB(A)	OIL-FREE, VERTICAL	£149.99	£179.99

Suitable for trade, workshop, medium-sized garage operators
Ideal for mobile environments



06459

IDEAL FOR GARAGES, WORKSHOPS AND MOBILE ENVIRONMENTS

OIL-LUBRICATED

EXTERNAL AIR FILTERS; EASY ACCESS FOR GENERAL MAINTENANCE

BUILT WITH AN EFFICIENT COOLING SYSTEM; EXTENDED LIFE OF THE COMPRESSOR

INTEGRATED PRESSURE SWITCH AND PRESSURE REGULATOR; EASY-TO-READ GAUGE AND ERGONOMIC PRESSURE REGULATOR CONTROL; QUICK RELEASE COUPLER; EURO-TYPE FITTING

NEW PRODUCT

13A 230v

06243

DESIGNED FOR SMALL WORKSHOPS AND TRADE APPLICATIONS

OIL-FREE
CLEAN AIR SUPPLY & MAINTENANCE-FREE

QUICK RELEASE COUPLER; EURO TYPE FITTING

SPACE-SAVING VERTICAL DESIGN

INTEGRATED TOP-MOUNTED CONTROL PANEL WITH EASY-TO-READ GAUGE

13A 230v

ITALIAN DESIGN

05325

DESIGNED FOR WORKSHOPS AND GARAGES

OIL-LUBRICATED V-TWIN PUMP

SMOOTH V-TWIN ALUMINIUM PUMP FOR OPTIMUM EFFICIENCY AND PERFORMANCE

BUILT WITH AN EFFICIENT COOLING SYSTEM; EXTENDED LIFE OF THE COMPRESSOR

INTEGRATED PRESSURE SWITCH AND PRESSURE REGULATOR; EASY-TO-READ GAUGE AND ERGONOMIC PRESSURE REGULATOR CONTROL; QUICK RELEASE COUPLER; EURO-TYPE FITTING

HIGH 14CFM PISTON DISPLACEMENT

NEW PRODUCT

13A 230v

06456

DESIGNED FOR WORKSHOPS AND GARAGES

OIL-LUBRICATED BELT-DRIVEN

BELT-DRIVEN WITH SLOWER RUNNING PUMPS FOR LONGER LIFE

CAST IRON BARREL FOR LONGER SERVICE LIFE

OVERSIZED CRANKCASE, FINNED MANIFOLDS AND DURABLE ALUMINIUM AFTERCOOLER FOR PROLONGED TRADE USE

IMPROVED 14CFM PISTON DISPLACEMENT

NEW PRODUCT

13A 230v

TO PLACE AN ORDER: ☎ 01509 500500

Item No	MODEL	INPUT SUPPLY	MOTOR	AIR RECEIVER SIZE	PISTON DISPLACEMENT	MAX. PRESSURE	NOISE LEVEL	ADDITIONAL FEATURES	EX. VAT	INC. VAT
06459	SIP DD 2HP 50ltr	230v (13A)	2hp	50ltr	8CFM	116psi (8bar)	94.5dB(A)	OIL-LUBRICATED	£149.99	£179.99
06243	SIP V245/50	230v (13A)	2hp	50ltr	8CFM	116psi (8bar)	97dB(A)	OIL-FREE	£219.99	£263.99
05325	SIP DDVT 3HP 50ltr V-Twin	230v (13A)	3hp	50ltr	HIGH 14CFM	145psi (10bar)	97dB(A)	OIL-LUBRICATED	£279.99	£335.99
06456	SIP BD 3HP 50ltr	230v (13A)	3hp	50ltr	HIGH 14CFM	145psi (10bar)	96dB(A)	OIL-LUBRICATED BELT-DRIVE	£499.99	£599.99



Suitable for trade, workshop, medium-sized garage operators
Ideal for mobile environments



06455



DESIGNED FOR WORKSHOPS
AND GARAGES

OIL-LUBRICATED
V-TWIN PUMP

SMOOTH V-TWIN ALUMINIUM PUMP
FOR OPTIMUM EFFICIENCY
AND PERFORMANCE

BUILT WITH AN EFFICIENT
COOLING SYSTEM; EXTENDED LIFE
OF THE COMPRESSOR

INTEGRATED PRESSURE SWITCH
AND PRESSURE REGULATOR;
EASY-TO-READ GAUGE AND
ERGONOMIC PRESSURE
REGULATOR CONTROL
QUICK RELEASE COUPLER;
EURO-TYPE FITTING



EXTERNAL AIR FILTERS; EASY ACCESS FOR
GENERAL MAINTENANCE



06245

DESIGNED FOR SMALL
WORKSHOPS AND TRADE
APPLICATIONS

OIL-FREE
CLEAN AIR SUPPLY &
MAINTENANCE-FREE



SCAN HERE



INTEGRATED TOP-MOUNTED
CONTROL PANEL WITH
EASY-TO-READ GAUGE



SPACE-SAVING
VERTICAL DESIGN



06458

IDEAL FOR GARAGES, WORKSHOPS
AND MOBILE ENVIRONMENTS

OIL-LUBRICATED
BELT-DRIVEN

BELT-DRIVEN WITH
SLOWER RUNNING PUMPS
FOR LONGER LIFE

CAST IRON BARREL
FOR LONGER SERVICE LIFE

OVERSIZED CRANKCASE,
FINNED MANIFOLDS AND DURABLE
ALUMINIUM AFTERCOOLER
FOR PROLONGED TRADE USE

IMPROVED
14CFM
PISTON
DISPLACEMENT



Item No	MODEL	INPUT SUPPLY	MOTOR	AIR RECEIVER SIZE	PISTON DISPLACEMENT	MAX. PRESSURE	NOISE LEVEL	ADDITIONAL FEATURES	EX. VAT	INC. VAT
06455	SIP DDVT 3HP 100ltr V-Twin	230v (13A)	3hp	100ltr	13CFM	145psi (10bar)	97dB(A)	OIL-LUBRICATED	£369.99	£443.99
06245	SIP V300/100	230v (13A)	2.5hp	100ltr	10CFM	116psi (8bar)	97dB(A)	OIL-FREE, VERTICAL	£399.99	£479.99
06458	SIP BD 3HP 100ltr	230v (13A)	3hp	100ltr	HIGH 14CFM	145psi (10bar)	96dB(A)	OIL-LUBRICATED	£569.99	£683.99

SIP Advanced Air Compressor Oil

- Formulated high-quality oil designed specifically for use with our range of air compressors
- SAE40, low carbon forming
- Supplied in 1ltr (02350) and 5ltr (02352) containers



Item No: 02350
£8.49 EX.VAT
£10.19 INC.VAT

Item No: 02352
£34.99 EX.VAT
£41.99 INC.VAT

Suitable for workshop, industrial & light commercial applications
Space-saving design is ideal for when space is at a premium



OVERSIZED CRANKCASE, CAST IRON BARREL & HEAVY-DUTY ALUMINIUM AFTERCOOLER

B2800 PUMP

3HP MOTOR

OIL-LUBRICATED BELT-DRIVEN

06323

SPACE SAVING DESIGN

- Space-saving vertical 'squat tank' design
- B2800 pump
- Belt-drive
- Oversized crankcase, cast iron barrel and heavy-duty aluminium aftercooler for prolonged trade use

MADE IN ITALY

OVERSIZED CRANKCASE, CAST IRON BARREL & HEAVY-DUTY ALUMINIUM AFTERCOOLER

NB5 HEAVY-DUTY PUMP

5.5HP MOTOR

OIL-LUBRICATED BELT-DRIVEN

06335

SPACE SAVING DESIGN

- Space-saving vertical 'squat tank' design
- NB5 heavy-duty pump
- Belt-drive
- Oversized crankcase, cast iron barrel and heavy-duty aluminium aftercooler for prolonged trade use

MADE IN ITALY

TO PLACE AN ORDER: ☎ 01509 500500

Item No	MODEL	INPUT SUPPLY	MOTOR	AIR RECEIVER SIZE	PISTON DISPLACEMENT	MAX. PRESSURE	NOISE LEVEL	OVERALL HEIGHT	EX. VAT	INC. VAT
06323	SIP VN3/150-SB	230v (13A)	3hp	150ltr	13CFM	145psi (10bar)	96dB(A)	1460mm	£849.99	£1019.99
06335	SIP VN5.5/150-TB	400v (20A) 3 phase	5.5hp	150ltr	24CFM	145psi (10bar)	97dB(A)	1750mm	£1399.99	£1679.99



Suitable for a range of trade and professional applications



06476



BELT-DRIVEN WITH SLOWER RUNNING PUMPS FOR LONGER LIFE

EXTRA STRONG MOULDED PLASTIC BELT & FLYWHEEL GUARDS
MULTI-FINNED FLYWHEEL FOR IMPROVED COOLING & LONGER PUMP LIFE

OIL-LUBRICATED BELT-DRIVEN

- Cast iron barrel for longer service life
- Oversized crankcase, finned manifolds and durable aluminium aftercooler for prolonged trade use
- Fitted with air regulator
- Supplied with 1/2" ball valve
- Wheel mounted air receiver

IMPROVED 14CFM PISTON DISPLACEMENT



05300



EXTRA STRONG MOULDED PLASTIC BELT & FLYWHEEL GUARDS
MULTI-FINNED FLYWHEEL FOR IMPROVED COOLING & LONGER PUMP LIFE

ULTRA HEAVY-DUTY B3800B PUMP

OIL-LUBRICATED BELT-DRIVEN

- Ultra heavy-duty B3800B pump
- Cast iron barrel for longer service life
- Oversized crankcase, finned manifolds and durable aluminium aftercooler for prolonged trade use

ANTI-VIBRATION MOUNTS AVAILABLE SEE BELOW



WHEEL KIT AVAILABLE ITEM: 02068 SEE BELOW



Item No	MODEL	INPUT SUPPLY	MOTOR	AIR RECEIVER SIZE	PISTON DISPLACEMENT	MAX. PRESSURE	NOISE LEVEL	ADDITIONAL FEATURES	EX. VAT	INC. VAT
06476	SIP BD 3HP 150ltr	230v (13A)	3hp	150ltr	HIGH 14CFM	145psi (10bar)	96dB(A)	-	£629.99	£755.99
05300	SIP PX3/150-SRB	230v (16A)	3hp	150ltr	16CFM	145psi (10bar)	97dB(A)	-	£699.99	£839.99



SIP Air Compressor Wheel Kits

02068 - for 150ltr models
02069 - for 200ltr models

Kit includes:

- 1x pull handle, 2x heavy-duty solid rubber wheels and 2x swivel castors

Item No: 02068

£83.99 EXVAT

£100.79 INCVAT

Item No: 02069

£89.99 EXVAT

£107.99 INCVAT

Anti-Vibration Mounts up to 250kg (sold singly)



Item No: 02357A

£8.79 EXVAT

£10.55 INCVAT

SIP AIR COMPRESSORS

Suitable for a range of trade and professional applications



06477

EXTRA STRONG MOULDED PLASTIC BELT & FLYWHEEL GUARDS
MULTI-FINNED FLYWHEEL FOR IMPROVED COOLING & LONGER PUMP LIFE

BELT-DRIVEN WITH SLOWER RUNNING PUMPS FOR LONGER LIFE

OIL-LUBRICATED BELT-DRIVEN

- Cast iron barrel for longer service life
- Oversized crankcase, finned manifolds and durable aluminium aftercooler for prolonged trade use
- Fitted with air regulator
- Supplied with 1/2" ball valve
- Wheel mounted air receiver

NEW PRODUCT

IMPROVED 14CFM PISTON DISPLACEMENT

13A 230v

05308

05311

EXTRA STRONG MOULDED PLASTIC BELT & FLYWHEEL GUARDS
MULTI-FINNED FLYWHEEL FOR IMPROVED COOLING & LONGER PUMP LIFE

ULTRA HEAVY-DUTY B3800B PUMP

OIL-LUBRICATED BELT-DRIVEN

- Ultra heavy-duty B3800B pump
- Cast iron barrel for longer service life
- Oversized crankcase, finned manifolds and durable aluminium aftercooler for prolonged trade use

HIGH 18CFM PISTON DISPLACEMENT

WHEEL KIT AVAILABLE ITEM: 02069 SEE PAGE 102

ANTI-VIBRATION MOUNTS AVAILABLE SEE PAGE 100

32A 230v 32A 400v

MADE IN ITALY

05302

EXTRA STRONG MOULDED PLASTIC BELT & FLYWHEEL GUARDS
MULTI-FINNED FLYWHEEL FOR IMPROVED COOLING & LONGER PUMP LIFE

OIL-LUBRICATED BELT-DRIVEN

- Ultra heavy-duty B3800B pump
- Cast iron barrel for longer service life
- Oversized crankcase, finned manifolds and durable aluminium aftercooler for prolonged trade use

HIGH 16CFM PISTON DISPLACEMENT

WHEEL KIT AVAILABLE ITEM: 02069 SEE PAGE 102

ANTI-VIBRATION MOUNTS AVAILABLE SEE PAGE 100

16A 230v

MADE IN ITALY

06583

2 STAGE HIGH EFFICIENCY PUMP

OIL-LUBRICATED BELT-DRIVEN

- Heavy-duty 2 stage pump
- Cast iron barrel for longer service life
- Oversized crankcase, finned manifolds and durable aluminium aftercooler for prolonged trade use

HIGH 24CFM PISTON DISPLACEMENT

SUPPLIED WITH ANTI-VIBRATION MOUNTS

Worth up to £100!

32A 400v

MADE IN ITALY

TO PLACE AN ORDER: 01509 500500

Item No	MODEL	INPUT SUPPLY	MOTOR	AIR RECEIVER SIZE	PISTON DISPLACEMENT	MAX. PRESSURE	WEIGHT	ADDITIONAL FEATURES	EX. VAT	INC. VAT
06477	SIP BD 3HP 200ltr	230v (13A)	3hp	200ltr	HIGH 14CFM	145psi (10bar)	84kg	-	£699.99	£839.99
05302	SIP PX3/200-SRB	230v (16A)	3hp	200ltr	HIGH 16CFM	145psi (10bar)	96kg	-	£749.99	£899.99
05308	SIP PX4/200B	230v (18A)	4hp	200ltr	HIGH 18CFM FROM 1 PHASE	145psi (10bar)	96kg	-	£849.99	£1019.99
05311	SIP PX4-3/200B	400v (20A) 3 Phase	4hp	200ltr	HIGH 18CFM	145psi (10bar)	96kg	-	£869.99	£1043.99
06583	SIP TN5.5/200	400v (20A) 3 Phase	5.5hp	200ltr	24CFM	145psi (10bar)	112kg	2 Stage Pump	£1299.99	£1559.99



Designed for industrial and professional applications



06585

06587



- OIL-LUBRICATED BELT-DRIVEN
 - 2 STAGE HIGH EFFICIENCY PUMP
 - CAST IRON BARREL FOR LONGER SERVICE LIFE
 - OVERSIZED CRANKCASE, FINNED MANIFOLDS AND DURABLE ALUMINIUM AFTERCOOLER FOR PROLONGED TRADE USE
 - SUPPLIED WITH ANTI-VIBRATION MOUNTS
- Worth up to £100!**



OVERSIZED CRANKCASE, FINNED MANIFOLDS AND DURABLE ALUMINIUM AFTERCOOLER FOR PROLONGED TRADE USE

CAST IRON BARREL FOR LONGER SERVICE LIFE

05251



- OIL-LUBRICATED BELT-DRIVEN
- DUAL PUMP CONTROL BOX
- TWIN B3800 PUMPS & TWIN 3HP MOTORS
- STAGGERED PUMP STARTING TO REDUCE CURRENT DRAW
- STRONG ALUMINIUM DIE-CAST VALVE PLATE



HIGH 32CFM FROM SINGLE PHASE

Item No	MODEL	INPUT SUPPLY	MOTOR	AIR RECEIVER SIZE	PISTON DISPLACEMENT	MAX. PRESSURE	WEIGHT	ADDITIONAL FEATURES	EX. VAT	INC. VAT
06585	SIP TN7.5/270	400v (20A) 3 Phase	75hp	270ltr	34CFM	145psi (10bar)	168kg	2 Stage Pump	£1599.99	£1919.99
06587	SIP TN10/270	400v (20A) 3 Phase	10hp	270ltr	42CFM	145psi (10bar)	201kg	STAR DELTA STARTER	£2499.99	£2999.99
05251	SIP B3800/270 Tandem	230v (32A)	2x 3hp	270ltr	HIGH 32CFM FROM 1 PHASE	145psi (10bar)	152.5kg	TWIN PUMPS TWIN MOTORS	£2399.99	£2879.99

Premium compressors for heavy-industrial applications



06289

06291

06295



- LARGE INTERSTAGE COOLERS - COOLER AIR, REDUCED MOISTURE & PUMP TEMPERATURE CONTROL
- LONG-STROKE CAST IRON CYLINDERS - SLOWER RUNNING & INCREASED PUMP LIFE
- 10 YEAR AIR RECEIVER ANTI-CORROSION WARRANTY

- OIL-LUBRICATED BELT-DRIVEN
- HEAVY-DUTY PUMP FOR INDUSTRIAL APPLICATIONS
- INDUSTRIAL 3 PHASE MOTORS
- ROBUST VALVE PLATE WITH INDIVIDUAL VALVES FOR EFFICIENT PERFORMANCE

SUPPLIED WITH ANTI-VIBRATION MOUNTS

Worth up to £100!



Item No	MODEL	INPUT SUPPLY	MOTOR	AIR RECEIVER SIZE	PISTON DISPLACEMENT	MAX. PRESSURE	WEIGHT	ADDITIONAL FEATURES	EX. VAT	INC. VAT
06289	SIP ISBD5.5/270	400v (20A) 3 Phase	5.5hp	270ltr	23.5CFM	160psi (11bar)	166kg	-	£1599.99	£1919.99
06291	SIP ISBD7.5/270	400v (20A) 3 Phase	75hp	270ltr	31CFM	160psi (11bar)	190kg	-	£1899.99	£2279.99
06295	SIP ISBD10/270	400v (20A) 3 Phase	10hp	270ltr	38CFM	160psi (11bar)	220kg	STAR DELTA STARTER	£2999.99	£3599.99

TO PLACE AN ORDER: www.sip-group.com

SIP AIR COMPRESSORS

Premium industrial compressors for heavy-industrial applications



06297

INDUSTRIAL 3 PHASE MOTORS

10 YEAR AIR RECEIVER ANTI-CORROSION WARRANTY



OIL-LUBRICATED BELT-DRIVEN

HEAVY-DUTY, SMOOTH V-TWIN PUMP FOR OPTIMUM EFFICIENCY AND PERFORMANCE FOR INDUSTRIAL APPLICATIONS

LARGE INTERSTAGE COOLERS - COOLER AIR, REDUCES MOISTURE & PUMP TEMPERATURE CONTROL

LONG-STROKE CAST IRON CYLINDERS - SLOWER RUNNING & INCREASED PUMP LIFE

ROBUST VALVE PLATE WITH INDIVIDUAL VALVES FOR EFFICIENT PERFORMANCE

SUPPLIED WITH ANTI-VIBRATION MOUNTS

Worth up to £100!



Item No	MODEL	INPUT SUPPLY	MOTOR	AIR RECEIVER SIZE	PISTON DISPLACEMENT	MAX. PRESSURE	WEIGHT	ADDITIONAL FEATURES	EX. VAT	INC. VAT
06297	SIP ISBD15/500	400v (32A) 3 Phase	15hp	500ltr	61.5CFM	160psi (11bar)	313kg	STAR DELTA STARTER	£3999.99	£4799.99

SIP COMPRESSED AIR DRYERS

Reduce moisture from the air supply and extends the life of air tools. Suitable for screw and piston compressors.



Item No	05303	05306	05307
MODEL	SIP PS9	SIP PS11	SIP PS17
INPUT SUPPLY	230v (13A)	230v (13A)	230v (13A)
LTR/MIN	900	1100	1700
FLOW RATE M ³ /HR	54	66	102
CFM	32	39	60
MAX. PRESSURE	232psi (16bar)	232psi (16bar)	232psi (16bar)
CONNECTION	½" BSP	½" BSP	1" BSP
EX. VAT	£854.99	£875.99	£941.99
INC. VAT	£1025.99	£1051.19	£1130.39



TO PLACE AN ORDER: ☎ 01509 500500



SIP Professional KOHLER Petrol-Powered Industrial Super Air Compressors

All Kohler petrol-powered air compressors are assembled by SIP in the UK and feature a 10 year anti-corrosion air receiver warranty.

10 YEAR AIR RECEIVER ANTI-CORROSION WARRANTY**

KOHLER
IN POWER. SINCE 1920.
3 YEAR ENGINE WARRANTY
PREMIER QUALITY

PETROL POWERED

ASSEMBLED & TESTED BY SIP IN THE UK

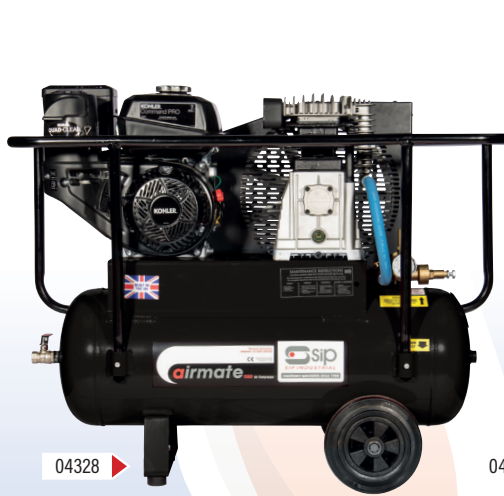

04328 ▶



04331 ▶

Item No	MODEL	ENGINE	AIR RECEIVER SIZE	PISTON DISPLACEMENT	MAX. AIR PRESSURE	FRAME DESIGN	ADDITIONAL FEATURES	EX. VAT	INC. VAT
04328	SIP Industrial Super ISKP7/50	KOHLER 7HP - 207CC	50ltr	16CFM	150psi (10.3bar)	✓	WHEEL KIT	£1099.99	£1319.99
04330	SIP Industrial Super ISKP7/150	KOHLER 7HP - 207CC	150ltr	16CFM	150psi (10.3bar)		-	£1299.99	£1559.99
04331	SIP Industrial Super ISKP7/150ES	KOHLER 7HP - 207CC	150ltr	16CFM	150psi (10.3bar)		ELECTRIC START*	£1449.99	£1739.99

SIP PROFESSIONAL HONDA™ PETROL ENGINE BELT-DRIVEN AIR COMPRESSORS

SIP Professional HONDA Petrol-Powered Industrial Super Air Compressors

All Honda petrol-powered air compressors are assembled by SIP in the UK and feature a 10 year anti-corrosion air receiver warranty.

10 YEAR AIR RECEIVER ANTI-CORROSION WARRANTY**

POWERED by **HONDA**™
2 year engine warranty
Honda GP Engines

POWERED by **HONDA**™
3 year engine warranty
Honda GX Engines
Reliability, excellent build quality, compact design, low oil alert

PETROL POWERED

ASSEMBLED & TESTED BY SIP IN THE UK

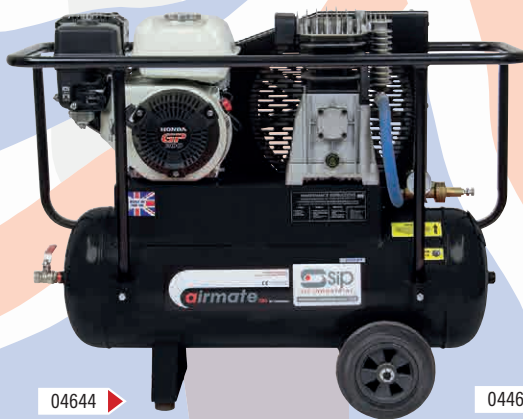

04644 ▶

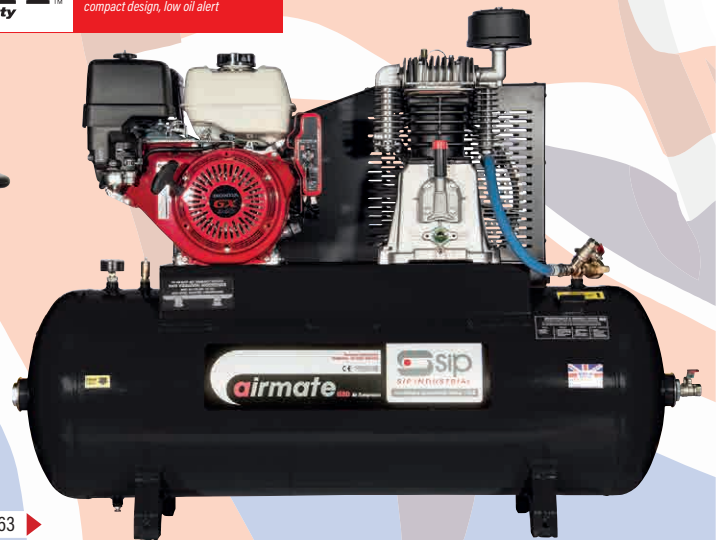

04463 ▶

Item No	MODEL	ENGINE	AIR RECEIVER SIZE	PISTON DISPLACEMENT	MAX. AIR PRESSURE	FRAME DESIGN	ADDITIONAL FEATURES	EX. VAT	INC. VAT
04644	SIP Industrial Super ISHP6/50	HONDA GP200 - 196CC	50ltr	16CFM	150psi (10.3bar)	✓	WHEEL KIT	£1149.99	£1379.99
04650	SIP Industrial Super ISHP6/150	HONDA GP200 - 196CC	150ltr	16CFM	150psi (10.3bar)		-	£1349.99	£1619.99
04444	SIP Industrial Super ISHP5.5/50	HONDA GX160 - 163CC	50ltr	16CFM	150psi (10.3bar)	✓	WHEEL KIT	£1249.99	£1499.99
04450	SIP Industrial Super ISHP5.5/150	HONDA GX160 - 163CC	150ltr	16CFM	150psi (10.3bar)		-	£1449.99	£1739.99
04451	SIP Industrial Super ISHP5.5/150ES	HONDA GX160 - 163CC	150ltr	16CFM	150psi (10.3bar)		ELECTRIC START*	£1799.99	£2159.99
04459	SIP Industrial Super ISHP11/150	HONDA GX340 - 340CC	150ltr	35CFM	150psi (10.3bar)		-	£2399.99	£2879.99
04465	SIP Industrial Super ISHP11/150ES	HONDA GX340 - 340CC	150ltr	35CFM	150psi (10.3bar)		ELECTRIC START*	£2699.99	£3239.99
04461	SIP Industrial Super ISHP11/200	HONDA GX340 - 340CC	200ltr	35CFM	150psi (10.3bar)		-	£2599.99	£3119.99
04463	SIP Industrial Super ISHP11/200ES	HONDA GX340 - 340CC	200ltr	35CFM	150psi (10.3bar)		ELECTRIC START*	£2849.99	£3419.99

Euro 5 Compliant Engines to meet emissions directive for non-road mobile machinery

*Battery and leads not included. **Subject to proof of compressor service.



HIGH QUALITY PREMIUM AIR COMPRESSORS



SILVERSTONE RANGE

Single Cylinder Oil-Free Compact Air Compressors

Direct drive crankshaft via the motor shaft

- Motors available up to 0.6HP / 0.45kW
- High-quality pumps with technopolymer piston rings
- Oil-free for long life and low maintenance
- Forced air cooling; longer run times
- 5ltr receiver
- Stand alone models; suitable for low pressure volume applications
- Integrated adjustable air pressure regulators
- Lightweight and portable; ideal for air brushing and nebulising applications
- 12 / 24v DC battery power models for tyre inflation
- Ideal for vehicle applications

12v / 24v DC Options Available



Silverstone 0.5HP (no tank)

FOR THE FULL RANGE VISIT OUR WEBSITE!

www.sip-group.com



ESPRIT RANGE

"Flat Twin" Cylinder Oil-Free Compact Air Compressors

Direct drive crankshaft via the motor shaft

- Motors available up to 0.9HP / 0.65kW
- High-quality pumps with technopolymer piston rings
- Oil-free for long life and low maintenance
- Forced air cooling; longer run times
- 3, 5, 10 and 15ltr tank options; suitable for low pressure volume applications
- Adjustable air pressure regulators
- Lightweight and portable; ideal for air brushing, nailing / stapling
- Low noise and Super Silenced models; perfect for indoor applications
- 12 / 24v DC options for special vehicle installations



Esprit 0.75HP 15L



Esprit 12v 0.8HP 3L



Esprit Silenced 0.75HP 2800rpm 5L

TO PLACE AN ORDER: 01509 500500

Item No	MODEL	INPUT	MOTOR	RECEIVER SIZE	PISTON DISP. CFM	F.A.D. CFM	MAX. PRESSURE	NOISE LEVEL	EX. VAT	INC. VAT
SIL56012	Silverstone 12 Volt 0.6HP 5L	12v DC	0.6hp	5ltr	3.5	2.5	8bar	72dB(A)	£489.99	£587.99
SIL56021224	Silverstone 12/24 Volt 0.5HP 5L	12v DC	0.5hp	5ltr	2.1	1.5	8bar	74dB(A)	£474.99	£569.99
		24v DC			4.2	2.9				
ESP1550024	Esprit 24v 0.75HP 15L	24v DC	0.75hp	15ltr	7.9	5.5	10bar	62dB(A)	£749.99	£899.99
ESP360012	Esprit 12v 0.8HP 3L	12v DC	0.8hp	3ltr	7.9	5.5	10bar	62dB(A)	£774.99	£929.99
ESP1560012	Esprit 12v 0.8HP 15L	12v DC	0.8hp	15ltr	7.9	5.5	10bar	62dB(A)	£854.99	£1025.99
SIL1602	Silverstone 0.5hp (No Tank)	230v	0.5hp	-	3.5	2.45	8bar	72dB(A)	£169.99	£203.99
SIL502	Silverstone 0.5HP 5L	230v	0.5hp	5ltr	3.5	2.45	8bar	52dB(A)	£234.99	£281.99
ESP3604	Esprit 0.75HP 3L	230v	0.75hp	3ltr	3.7	2.6	10bar	74dB(A)	£399.99	£479.99
ESP15604	Esprit 0.75HP 15L	230v	0.75hp	15ltr	3.7	2.6	10bar	52dB(A)	£454.99	£545.99
ESP10604	Esprit 0.75HP 10L (Wheel Mounted Trolley)	230v	0.75hp	10ltr	3.7	2.6	10bar	52dB(A)	£469.99	£563.99
ESP5604	Esprit Silenced 0.75HP 1400rpm 5L	230v	0.75hp	5ltr	3.7	2.6	10bar	48dB(A)	£744.99	£893.99

HIGH QUALITY PREMIUM AIR COMPRESSORS



HOOKAH SNORKELLING EXTREME RANGE

BREATHING AIR COMPRESSORS FOR SNORKELLING TO 15mtrs

"V Twin" Oil-Free Compact High Performance Air Compressors
Direct drive crankshaft via the motor shaft

- 230v AC, 12 / 24v DC models
- Power options up to 2hp
- Oil-free for long life and low maintenance pumps
- Forced air cooling; longer run times
- 5 / 7ltr receivers
- Adjustable air pressure
- Lightweight and portable, perfect for outdoor use

Standard Configuration

- HOOKAH Extreme Compressor
- 1x Breathing Air Filter
- 1x 17mtr hose with snorkel tube / valve



HOOKAH Snorkelling Extreme 3T 230v Electric Motor-Driven



HOOKAH Snorkelling Extreme 5G Petrol Engine-Driven

EXTREME PORTABLE & EXTREME SILENCED RANGE

"V Twin" Cylinder Oil-Free Compact High Performance Air Compressors
Direct drive crankshaft via the motor shaft

- Motors available up to 2HP / 1.5KW
- Oil-free for long life and low maintenance pumps
- Forced air cooling; longer run times
- 5 to 30ltr & 25 or 50ltr (LOW NOISE) receiver options
- Integrated adjustable air pressure regulators
- Lightweight and portable models
- 12 / 24v DC options for special vehicle installations*
- Low noise option; perfect for noise critical situations



Extreme 1.5HP 5L



Extreme 3.0HP 7L Petrol Engine



Stainless Steel Valve Plates



Crankcase Air Intakes



Cylinder Head Air Filters



Technopolymer Piston Rings



Concentric 'Big End' Bearings

EXTREME WORKSHOP RANGE INDUSTRIAL AIR COMPRESSORS

"V Twin" Cylinder Oil-Free Compact High Performance Air Compressors
Direct drive crankshaft via the motor shaft

- Single and 3 phase motors available up to 3HP / 2.2KW
- High-quality 2 and 4 cylinder pumps
- Oil-free for long life and low maintenance
- 50 and 90ltr receiver options
- Suitable for low / medium volume and low pressure applications
- Adjustable air pressure regulators
- Lightweight and portable models
- Low noise; perfect for noise critical situations



Extreme 2.0HP 50L



Extreme 2.5HP 90L

Item No	MODEL	INPUT	MOTOR	RECEIVER SIZE	PISTON DISP. CFM	F.A.D. CFM	MAX. PRESSURE	NOISE LEVEL	EX. VAT	INC. VAT
NAR5154	Hookah Snorkelling Extreme 3T 1.5HP	230v	1.5hp	5ltr	8.5	6	10bar	70dB(A)	£829.99	£995.99
NAR5204	Hookah Snorkelling Extreme 3T 2HP 230v	230v	2.0hp	5ltr	12.4	8.7	10bar	71dB(A)	£964.99	£1157.99
NAR780012	Hookah Snorkelling Extreme 3 12v	12v DC	1.1hp	7ltr	8.8	6	10bar	70dB(A)	£1324.99	£1589.99
NAR73070P	Hookah Snorkelling Extreme 5G (70)	24v DC	1.1hp	7ltr	13.4	9.4	10bar	70dB(A)	£1274.99	£1529.99
EXT780024	Extreme 24v 1.1HP 7L	12v DC	1.5hp	30ltr	8.8	6.2	10bar	72dB(A)	£1074.99	£1289.99
EXT100754	Extreme 0.75HP 10L	230v	0.75hp	10ltr	7.0	4.9	10bar	72dB(A)	£579.99	£695.99
EXT5154	Extreme 1.5HP 5L	230v	1.5hp	5ltr	8.5	6.0	10bar	72dB(A)	£509.99	£611.99
EXT50204	Extreme 2.0HP 50L	230v	2.0hp	50ltr	12.4	8.7	10bar	73dB(A)	£779.99	£935.99
EXTS50204	Extreme Silenced 2.0HP 50L	230v	2.0hp	50ltr	12.4	8.7	10bar	67dB(A)	£1209.99	£1451.99
EXT90254	Extreme 2.5HP 90L	230v	2.5hp	90ltr	17.0	11.9	10bar	73dB(A)	£1344.99	£1613.99
EXT90304	Extreme 3.0HP 90L	400v	3.0hp	90ltr	12.2	14.9	10bar	73dB(A)	£1464.99	£1757.99
EXT73060P	Extreme 3.0HP 7L Petrol Engine Driven	Petrol	3.0hp	7ltr	9.5	6.7	10bar	85dB(A)	£1129.99	£1355.99



TO PLACE AN ORDER: www.sip-group.com

HIGH QUALITY PREMIUM AIR COMPRESSORS



EXTREME MP MULTI-POWER RANGE

INDUSTRIAL AIR COMPRESSORS

'V Twin' Oil-Free Industrial High Performance Air Compressors

Due to the unique design the MP range of compressors are extremely low maintenance:

- Oil free - No oil to check / change
- Direct drive - No drive belt to adjust
- Unique air intake - Lengthens the life of the air filter element
- Low noise compared with traditional piston compressors, around 25dB reduction (or 25%)

Available in high performing 4, 8 & 12 cylinder models, mounted on 200L, 270L & 500L air receivers.

Supplied with single and 3 phase motors ranging from 2.5HP - 9.0HP.



LOW MAINTENANCE

LOW NOISE



EXCLUSIVE TO SIP*

ONLY AVAILABLE FROM SIP:

- Extreme MP 2.5HP 4 cylinder - 200L
- Extreme MP 3.0HP 4 cylinder - 200L
- Extreme MP 5.0HP 8 cylinder - 200L Tandem
- Extreme MP 6.0HP 8 cylinder - 200L Tandem

*only applicable to UK

SUPER EXTREME RANGE

INDUSTRIAL AIR COMPRESSORS

'V-Twin' Oil-Free Compact High Performance Air Compressors

Direct drive crankshaft via the motor shaft

- 2.2HP / 1.6kW slow-running 4-pole motors
- High-quality 2 stage, 2 and 4 cylinder pumps fitted with technopolymer piston rings; oil-free for long life and low maintenance
- Mid-stage intercooler
- Unique crankcase air intake particle diffusion; reduced air contamination ensuring longer life of the valve plate
- 18 and 20ltr aluminium receiver options; suitable for low volume and medium pressure (30bar) applications
- Twin colour coded outlets; 10 and 30bar variable
- Lightweight and portable models; ideal for medium flow and pressure applications

30 BAR

Item No	MODEL	INPUT	MOTOR	DRYER	RECEIVER SIZE	PISTON DISP. CFM	F.A.D. CFM	MAX. PRESSURE	NOISE LEVEL	EX. VAT	INC. VAT
SEXT1822430	Super Extreme 2.2HP 2x 9L 30 Bar (Double Pressure)	230v	2.2hp	n/a	9+9ltr	4.6	3.2	30bar	72dB(A)	£1499.99	£1799.99
SEXT2022430	Super Extreme 2.2HP 20L 30 Bar	230v	2.2hp	n/a	20ltr	4.6	3.2	30bar	72dB(A)	£1674.99	£2009.99

HIGH QUALITY PREMIUM AIR COMPRESSORS



INTELLIGENT CONTROL PANEL

- Bespoke multi-pump control panel; electrical cost-saving, even power distribution across each motor pump configuration
- Service interval indicator; maintain optimum performance and reliability
- Control panel controls up to 3 motor / pump units continually dependant on air requirements; optimises pump usage and energy cost saver
- Individual pump hour meters and timers; microprocessor controlled pump selection for even power distribution, wear and tear

Extreme MP 9.0HP 12 cylinder 270L with Control Panel

Item No	MODEL	INPUT	MOTOR	RECEIVER SIZE	PISTON DISP. CFM	F.A.D. CFM	MAX. PRESSURE	NOISE LEVEL	EX. VAT	INC. VAT
EXTMP20025	Extreme MP 2.5HP 4 cylinder 200L	230v	2.5hp	200ltr	17.0	11.9	10bar	73dB(A)	£1599.99	£1919.99
EXTMP20030	Extreme MP 3.0HP 4 cylinder 200L	400v	3.0hp	200ltr	21.2	14.9	10bar	73dB(A)	£1899.99	£2279.99
EXTMP20050	Extreme MP 5.0HP 8 cylinder 200L Tandem	230v	2x 2.5hp	200ltr	34.0	23.8	10bar	74dB(A)	£2599.99	£3119.99
EXTMP20060	Extreme MP 6.0HP 8 cylinder 200L Tandem	400v	2x 3.0hp	200ltr	42.2	29.8	10bar	74dB(A)	£2799.99	£3359.99
EXTMP27030	Extreme MP 3.0HP 4 cylinder 270L	400v	3.0hp	270ltr	21.2	14.9	10bar	73dB(A)	£2729.99	£3275.99
EXTMP27090CP	Extreme MP 9.0HP 12 cylinder 270L (Tri-Motor Pump & Control Panel)	400v	3x 3.0hp	270ltr	63.6	44.5	10bar	75dB(A)	£6569.99	£7883.99



Super Extreme 2.2HP 2x 9L 30 Bar (SEXTI822430)



Super Extreme 2.2HP 20L 30 Bar (SEXT2022430)

TO PLACE AN ORDER: www.sip-group.com



NEW RANGE

SIP INDUSTRIAL VSDD ROTARY SCREW AIR COMPRESSORS

SIP'S latest generation of variable speed direct drive compressors are fully configurable with a range of supply, output and receiver tank size options.

These highly efficient compressors offer a greater operating range to meet high-demand air requirements and optimise energy usage.



PRECISION ENGINEERED TWIN PARALLEL ROTARY SCREWS

- DIRECT DRIVE TRANSMISSION NEGATES SLIPPAGE FOR GREATER POWER TRANSFER
- SILENCED CABINET ENSURES REDUCED NOISE OPERATION
- WHEEL MOUNTED FOR ADDED MOBILITY
- EASY ACCESS CABINET FOR MAINTENANCE & SERVICE

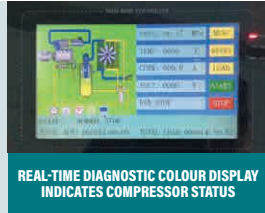

REAL-TIME DIAGNOSTIC COLOUR DISPLAY INDICATES COMPRESSOR STATUS

- DIRECT DRIVE TRANSMISSION NEGATES SLIPPAGE FOR GREATER POWER TRANSFER
- SILENCED CABINET ENSURES REDUCED NOISE OPERATION
- ALL-IN-ONE DESIGN ENSURES SMALLER OVERALL FOOTPRINT
- EASY ACCESS CABINET FOR MAINTENANCE & SERVICE



REAL-TIME DIAGNOSTIC COLOUR DISPLAY INDICATES COMPRESSOR STATUS

- 08254
- 08250
- 08255
- 08251
- 08256
- 08252
- 08257
- 08253



- 16A 230v
- 32A 230v
- 64A 230v

VARIABLE SPEED MOTOR

100% UK TESTED BEFORE DESPATCH



- 08258
- 08260
- 08259
- 08261
- 08262
- 08265
- 08263
- 06268



VARIABLE SPEED MOTOR

100% UK TESTED BEFORE DESPATCH



TO PLACE AN ORDER: 01509 500500

Item No	MODEL	INPUT	MOTOR (IE4)	RECEIVER SIZE	FREE AIR DELIVERY	MAX. WORKING PRESSURE	NOISE LEVEL	EX. VAT	INC. VAT
08254	SIP VSDD 2.2kW 8bar 160ltr	230v (16A)	2.2kW (3hp)	160ltr	9CFM (255ltr/min)	116psi (8bar)	65dB(A)	£2389.99	£2867.99
08250	SIP VSDD 2.2kW 10bar 160ltr	230v (16A)	2.2kW (3hp)	160ltr	8CFM (220ltr/min)	145psi (10bar)	65dB(A)	£2389.99	£2867.99
08255	SIP VSDD 3.0kW 8bar 160ltr	230v (32A)	3kW (4hp)	160ltr	13CFM (380ltr/min)	116psi (8bar)	65dB(A)	£2489.99	£2987.99
08251	SIP VSDD 3.0kW 10bar 160ltr	230v (32A)	3kW (4hp)	160ltr	11CFM (310ltr/min)	145psi (10bar)	65dB(A)	£2489.99	£2987.99
08256	SIP VSDD 4.0kW 8bar 160ltr	230v (32A)	4kW (5hp)	160ltr	19CFM (530ltr/min)	116psi (8bar)	65dB(A)	£2559.99	£3071.99
08252	SIP VSDD 4.0kW 10bar 160ltr	230v (32A)	4kW (5hp)	160ltr	16CFM (450ltr/min)	145psi (10bar)	65dB(A)	£2559.99	£3071.99
08257	SIP VSDD 5.5kW 8bar 160ltr	230v (64A)	5.5kW (7hp)	160ltr	25CFM (720ltr/min)	116psi (8bar)	65dB(A)	£2899.99	£3479.99
08253	SIP VSDD 5.5kW 10bar 160ltr	230v (64A)	5.5kW (7hp)	160ltr	22CFM (630ltr/min)	145psi (10bar)	65dB(A)	£2899.99	£3479.99
08258	SIP VSDD 5.5kW 8bar 200ltr	400v (32A)	5.5kW (7hp)	200ltr	25CFM (720ltr/min)	116psi (8bar)	62dB(A)	£3199.99	£3839.99
08260	SIP VSDD 5.5kW 10bar 200ltr	400v (32A)	5.5kW (7hp)	200ltr	22CFM (630ltr/min)	145psi (10bar)	62dB(A)	£3199.99	£3839.99
08259	SIP VSDD 7.5kW 8bar 200ltr	400v (32A)	7.5kW (10hp)	200ltr	37CFM (1050ltr/min)	116psi (8bar)	62dB(A)	£3289.99	£3947.99
08261	SIP VSDD 7.5kW 10bar 200ltr	400v (32A)	7.5kW (10hp)	200ltr	32CFM (920ltr/min)	145psi (10bar)	62dB(A)	£3289.99	£3947.99
08262	SIP VSDD 11kW 8bar 500ltr	400v (64A)	11kW (15hp)	500ltr	57CFM (1613ltr/min)	116psi (8bar)	62dB(A)	£3919.99	£4703.99
08265	SIP VSDD 11kW 10bar 500ltr	400v (64A)	11kW (15hp)	500ltr	50CFM (1415ltr/min)	145psi (10bar)	62dB(A)	£3919.99	£4703.99
08263	SIP VSDD 15kW 8bar 500ltr	400v (64A)	15kW (20hp)	500ltr	75CFM (2123ltr/min)	116psi (8bar)	62dB(A)	£4389.99	£5267.99
08268	SIP VSDD 15kW 10bar 500ltr	400v (64A)	15kW (20hp)	500ltr	66CFM (1868ltr/min)	145psi (10bar)	62dB(A)	£4389.99	£5267.99



NEW RANGE

SIP INDUSTRIAL VSDD ROTARY SCREW AIR COMPRESSORS WITH DRYERS

Fitted with refrigerated dryer to reduce air moisture and available with optional particulate and oil filtration system to support guidelines in meeting air quality standard classification 2-4-2 in accordance with ISO 8573-1.

DIRECT DRIVE TRANSMISSION NEGATES SLIPPAGE FOR GREATER POWER TRANSFER
CONFIGURABLE WITH 200LTR OR 500LTR RECEIVER TANK

INTEGRATED REFRIGERATED DRYER REDUCES AIR MOISTURE
EASY ACCESS CABINET FOR MAINTENANCE & SERVICE



PRECISION ENGINEERED TWIN PARALLEL ROTARY SCREWS



REAL-TIME DIAGNOSTIC COLOUR DISPLAY INDICATES COMPRESSOR STATUS

SIP COMPRESSOR PARTICULATE & OIL FILTRATION SYSTEM

Consists of:
Particulate filter ≤ 1µm (particle Ø)
Coalescing filter ≤ 0.01µm (particle Ø)
Brackets and fixing kit included.

For use with SIP VSDD range of Rotary Screw compressors.



Item No: 08299

£599.99 EX.VAT

£719.99 INC.VAT

- 08264
- 08271
- 08269
- 08280
- 08266
- 08272
- 08277
- 08276
- 08267
- 08273
- 08274
- 08281



VARIABLE SPEED MOTOR



100% UK TESTED BEFORE DESPATCH



Item No	MODEL	INPUT	MOTOR (IE4)	RECEIVER SIZE	FREE AIR DELIVERY	MAX. WORKING PRESSURE	NOISE LEVEL	EX. VAT	INC. VAT
08264	SIP VSDD/RD 7.5kW 8bar 200Ltr with Dryer	400v (32A)	7.5kW (10hp)	200ltr	37CFM (1050ltr/min)	116psi (8bar)	62dB(A)	£4069.99	£4883.99
08271	SIP VSDD/RD 7.5kW 10bar 200Ltr with Dryer	400v (32A)	7.5kW (10hp)	200ltr	32CFM (920ltr/min)	145psi (10bar)	62dB(A)	£4069.99	£4883.99
08269	SIP VSDD/RDF 7.5kW 8bar 200Ltr with Dryer & Filter	400v (32A)	7.5kW (10hp)	200ltr	37CFM (1050ltr/min)	116psi (8bar)	62dB(A)	£4699.99	£5639.99
08280	SIP VSDD/RDF 7.5kW 10bar 200Ltr with Dryer & Filter	400v (32A)	7.5kW (10hp)	200ltr	32CFM (920ltr/min)	145psi (10bar)	62dB(A)	£4699.99	£5639.99
08266	SIP VSDD/RD 11kW 8bar 500Ltr with Dryer	400v (32A)	11kW (15hp)	500ltr	57CFM (1613ltr/min)	116psi (8bar)	62dB(A)	£4899.99	£5879.99
08272	SIP VSDD/RD 11kW 10bar 500Ltr with Dryer	400v (32A)	11kW (15hp)	500ltr	50CFM (1415ltr/min)	145psi (10bar)	62dB(A)	£4899.99	£5879.99
08277	SIP VSDD/RDF 11kW 8bar 500Ltr with Dryer & Filter	400v (32A)	11kW (15hp)	500ltr	57CFM (1613ltr/min)	116psi (8bar)	62dB(A)	£5499.99	£6599.99
08276	SIP VSDD/RDF 11kW 10bar 500Ltr with Dryer & Filter	400v (32A)	11kW (15hp)	500ltr	50CFM (1415ltr/min)	145psi (10bar)	62dB(A)	£5499.99	£6599.99
08267	SIP VSDD/RD 15kW 8bar 500Ltr with Dryer	400v (64A)	15kW (20hp)	500ltr	75CFM (2123ltr/min)	116psi (8bar)	62dB(A)	£5469.99	£6563.99
08273	SIP VSDD/RD 15kW 10bar 500Ltr with Dryer	400v (64A)	15kW (20hp)	500ltr	66CFM (1868ltr/min)	145psi (10bar)	62dB(A)	£5469.99	£6563.99
08274	SIP VSDD/RDF 15kW 8bar 500Ltr with Dryer & Filter	400v (64A)	15kW (20hp)	500ltr	75CFM (2123ltr/min)	116psi (8bar)	62dB(A)	£5999.99	£7199.99
08281	SIP VSDD/RDF 15kW 10bar 500Ltr with Dryer & Filter	400v (64A)	15kW (20hp)	500ltr	66CFM (1868ltr/min)	145psi (10bar)	62dB(A)	£5999.99	£7199.99

TO PLACE AN ORDER: www.sip-group.com



SIP INDUSTRIAL BELT-DRIVEN ROTARY SCREW AIR COMPRESSORS

SIP rotary screw non-dryer air compressors for industrial and professional applications
 IE3 Premium Efficiency motors for reduced CO2 emissions
 ETM II electronic controller



SILENCED CABINET ENCLOSURE HELP MAINTAIN THE INTERNAL TEMPERATURE AND REDUCE NOISE LEVELS
 BELT-DRIVEN TRANSMISSION
 HEAVY-DUTY COOLING FAN; MAINTAINS 100% DUTY CYCLE
 FRONT & REAR ACCESS PANELS FOR EASY SERVICING AND MAINTENANCE
 ITALIAN-MANUFACTURED AIR END DELIVERS HIGH CONSTANT AIR FLOW

ELECTRONIC CONTROL;
 DIGITAL DISPLAY WITH PRESSURE,
 HOURS, TEMPERATURE RANGES

- 05372
- 05374
- 05375
- 05376
- 06201



FS14 AIR END

- 06275
- 06285
- 06287
- 06384
- 06410
- 06200
- 06269
- 06337



FS26Tf AIR END



TO PLACE AN ORDER: ☎ 01509 500500

Item No	MODEL	INPUT	MOTOR (IE3)	RECEIVER SIZE	FREE AIR DELIVERY	MAX. WORKING PRESSURE	NOISE LEVEL	EX. VAT	INC. VAT
05375	SIP RS2.2-10-200BD	230v (16A)	2.2kW (3hp)	200ltr	8.5CFM (240ltr/min)	145psi (8bar)	58dB(A)	£2939.99	£3527.99
05372A	SIP RS4.0-08-200BD	400v (20A)	4kW (5.5hp)	200ltr	20.5CFM (580ltr/min)	116psi (8bar)	60dB(A)	£3339.99	£4007.99
05374	SIP RS4.0-10-200BD	400v (20A)	4kW (5.5hp)	200ltr	17CFM (480ltr/min)	145psi (10bar)	60dB(A)	£3339.99	£4007.99
05376A	SIP RS5.5-08-270BD	400v (20A)	5.5kW (7.5hp)	270ltr	25.4CFM (720ltr/min)	116psi (8bar)	64dB(A)	£3439.99	£4127.99
06201	SIP RS 5.5-10-270BD	400v (20A)	5.5kW (7.5hp)	270ltr	23CFM (650ltr/min)	145psi (10bar)	64dB(A)	£3439.99	£4127.99
06275A	SIP RS08-08-270BD	400v (32A)	7.5kW (10hp)	270ltr	44.1CFM (1,249ltr/min)	116psi (8bar)	68dB(A)	£3999.99	£4799.99
06285	SIP RS08-10-270BD	400v (32A)	7.5kW (10hp)	270ltr	35.3CFM (999ltr/min)	145psi (10bar)	69dB(A)	£3999.99	£4799.99
06387A	SIP RS08-08-500BD	400v (32A)	7.5kW (10hp)	500ltr	44.1CFM (1,249ltr/min)	116psi (8bar)	69dB(A)	£4289.99	£5147.99
06287	SIP RS08-10-500BD	400v (32A)	7.5kW (10hp)	500ltr	35.3CFM (999ltr/min)	145psi (10bar)	68dB(A)	£4289.99	£5147.99
06384A	SIP RS11-08-270BD	400v (40A)	11kW (15hp)	270ltr	58.2CFM (1,648ltr/min)	116psi (8bar)	69dB(A)	£4239.99	£5087.99
06410	SIP RS11-10-270BD	400v (40A)	11kW (15hp)	270ltr	53CFM (1,501ltr/min)	145psi (10bar)	69dB(A)	£4239.99	£5087.99
06302A	SIP RS11-08-500BD	400v (40A)	11kW (15hp)	500ltr	58.2CFM (1,648ltr/min)	116psi (8bar)	69dB(A)	£4519.99	£5423.99
06200	SIP RS11-10-500BD	400v (40A)	11kW (15hp)	500ltr	53CFM (1,501ltr/min)	145psi (10bar)	69dB(A)	£4519.99	£5423.99
06369A	SIP RS15-08-500BD	400v (40A)	15kW (20hp)	500ltr	75.6CFM (2,141ltr/min)	116psi (8bar)	70dB(A)	£4839.99	£5807.99
06269	SIP RS15-10-500BD	400v (40A)	15kW (20hp)	500ltr	65.3CFM (1,841ltr/min)	145psi (10bar)	70dB(A)	£4839.99	£5807.99
06337	SIP RS15-13-500BD	400v (40A)	15kW (20hp)	500ltr	53CFM (1,501ltr/min)	189psi (13bar)	70dB(A)	£5139.99	£6167.99



SIP INDUSTRIAL BELT-DRIVEN ROTARY SCREW AIR COMPRESSORS WITH DRYERS

SIP rotary screw air compressors for industrial and professional applications with refrigeration dryers for instant operation
IE3 Premium Efficiency motors for reduced CO2 emissions
ETM II electronic controller



SILENCED CABINET ENCLOSURE HELP MAINTAIN THE INTERNAL TEMPERATURE AND REDUCE NOISE LEVELS

BELT-DRIVEN TRANSMISSION

INTEGRATED REFRIGERATION DRYER

HEAVY-DUTY COOLING FAN; MAINTAINS 100% DUTY CYCLE

FRONT & REAR ACCESS PANELS FOR EASY SERVICING AND MAINTENANCE

ITALIAN DESIGNED & MANUFACTURED AIR ENDS, THESE ARE THE HEART OF THE MACHINE DELIVERING HIGH CONSTANT AIR FLOW

ELECTRONIC CONTROL;
 DIGITAL DISPLAY WITH PRESSURE,
 HOURS, TEMPERATURE RANGES

- 05378
- 06274
- 06267
- 06303



- 06310
- 06322
- 06412
- 06416
- 06283
- 06328
- 06420
- 06299
- 06263
- 06357



Item No	MODEL	INPUT	MOTOR (IE3)	RECEIVER SIZE	FREE AIR DELIVERY	MAX. WORKING PRESSURE	NOISE LEVEL	EX. VAT	INC. VAT
05378A	SIP RS4.0-08-200BD/RD	400v (20A)	4kW (5.5hp)	200ltr	20.5CFM (580ltr/min)	116psi (8bar)	60dB(A)	£3839.99	£4607.99
06274	SIP RS4.0-10-200BD/RD	400v (20A)	4kW (5.5hp)	200ltr	17CFM (485ltr/min)	145psi (10bar)	60dB(A)	£3839.99	£4607.99
06267A	SIP RS5.5-08-270BD/RD	400v (20A)	5.5kW (7.5hp)	270ltr	25.5CFM (720ltr/min)	116psi (8bar)	64dB(A)	£4319.99	£5183.99
06303	SIP RS5.5-10-270BD/RD	400v (20A)	5.5kW (7.5hp)	270ltr	23CFM (650ltr/min)	145psi (10bar)	64dB(A)	£4319.99	£5183.99

Item No	MODEL	INPUT	MOTOR (IE3)	RECEIVER SIZE	FREE AIR DELIVERY	MAX. WORKING PRESSURE	NOISE LEVEL	EX. VAT	INC. VAT
06310A	SIP RS08-08-270BD/RD	400v (32A)	7.5kW (10hp)	270ltr	44.1CFM (1,249ltr/min)	116psi (8bar)	68dB(A)	£4929.99	£5915.99
06322	SIP RS08-10-270BD/RD	400v (32A)	7.5kW (10hp)	270ltr	35.3CFM (999ltr/min)	145psi (10bar)	69dB(A)	£4929.99	£5915.99
06412A	SIP RS11-08-270BD/RD	400v (40A)	11kW (15hp)	270ltr	58.2CFM (1,648ltr/min)	116psi (8bar)	69dB(A)	£5139.99	£6167.99
06416	SIP RS11-10-270BD/RD	400v (40A)	11kW (15hp)	270ltr	53CFM (1,501ltr/min)	145psi (10bar)	69dB(A)	£5139.99	£6167.99
06283A	SIP RS08-08-500BD/RD	400v (32A)	7.5kW (10hp)	500ltr	44.1CFM (1,249ltr/min)	116psi (8bar)	68dB(A)	£5139.99	£6167.99
06328	SIP RS08-10-500BD/RD	400v (32A)	7.5kW (10hp)	500ltr	35.3CFM (999ltr/min)	145psi (10bar)	68dB(A)	£5139.99	£6167.99
06430A	SIP RS11-08-500BD/RD	400v (40A)	11kW (15hp)	500ltr	58.2CFM (1,648ltr/min)	116psi (8bar)	69dB(A)	£5439.99	£6527.99
06420	SIP RS11-10-500BD/RD	400v (40A)	11kW (15hp)	500ltr	53CFM (1,501ltr/min)	145psi (10bar)	69dB(A)	£5439.99	£6527.99
06299A	SIP RS15-08-500BD/RD	400v (40A)	15kW (20hp)	500ltr	75.9CFM (2,149ltr/min)	116psi (8bar)	70dB(A)	£5639.99	£6767.99
06263	SIP RS15-10-500BD/RD	400v (40A)	15kW (20hp)	500ltr	65.3CFM (1,849ltr/min)	145psi (10bar)	70dB(A)	£5639.99	£6767.99
06357	SIP RS15-13-500BD/RD	400v (40A)	15kW (20hp)	500ltr	53CFM (1,501ltr/min)	189psi (13bar)	70dB(A)	£6339.99	£7607.99

TO PLACE AN ORDER: www.sip-group.com



SIP INDUSTRIAL FULL-FEATURE BELT-DRIVEN ROTARY SCREW AIR COMPRESSORS

All-in-one air compressor workstations

- Complete range from 7.5 to 22kW
- Integrated compressor, receiver, dryer & filter
- High-quality clean air 2-4-2 classification (in accordance with ISO 8573-1)
- Simple installation & maintenance
- Designed for continuous use



INTEGRATED DRYERS AND FILTERS
THE SIP ROTARY SCREW FULL-FEATURE MODELS FEATURE FULLY INTEGRATED AIR TREATMENT MODULES, INCLUDING:-
GENEROUSLY SIZED REFRIGERATOR AIR DRYERS WITH 3°C DEW POINT
10 MICRON INLET FILTRATION
1 MICRON OUTLET FILTRATION

ALL-IN-ONE SYSTEM WITH COMPACT & MODERN DESIGN WITH EASY ACCESS SERVICING & MAINTENANCE
BELT-DRIVEN TRANSMISSION

INTEGRATED AIR SYSTEM PROVIDES BOTH DRY AND CLEAN AIR TO QUALITY STANDARD CLASSIFICATION 2 - 4 - 2, IN ACCORDANCE WITH ISO 8573-1

DRY TANK TECHNOLOGY; CONSTANT FLOW OF AIR, REDUCES CORROSION

ITALIAN DESIGNED & MANUFACTURED AIR ENDS, THESE ARE THE HEART OF THE MACHINE DELIVERING HIGH CONSTANT AIR FLOW

THE AIR END, DRYER, FILTERS, CONTROLLER, AND RECEIVER ARE IN A SINGLE MODULAR UNIT, PROVIDING A SPACE-SAVING SOLUTION



FULLY AUTOMATIC, INTEGRATED, SELF-MONITORING



FS26TF AIR END
(ITEMS: 06533, 34, 35 & 36)



FS50TF AIR END
(ITEMS: 06537)



06533

06534

270 LITRE



06535

06536

06537

500 LITRE



TO PLACE AN ORDER: 01509 500500

Item No	MODEL	INPUT	MOTOR (IE3)	RECEIVER SIZE	FREE AIR DELIVERY	NOISE LEVEL*	MAX. WORKING PRESSURE	FEATURES			AIR QUALITY	EX. VAT	INC. VAT
								PARTICULATE FILTER	REFRIGERATOR DRYER	OIL FILTER			
06533	SIP RS7.5-10-270BD/FF	400v (32A)	7.5kW (10hp)	270ltr	35.3 (999ltr/min)	62dB(A)	10bar	10 Micron	3°C (Dew Point)	1 Micron	2-4-2 ISO 8573-1	£5499.99	£6599.99
06534	SIP RS11-10-270BD/FF	400v (40A)	11kW (15hp)	270ltr	53 (1500ltr/min)	65dB(A)						£5769.99	£6923.99
06535	SIP RS11-10-500BD/FF	400v (40A)	11kW (15hp)	500ltr	53 (1500ltr/min)	65dB(A)						£5999.99	£7199.99
06536	SIP RS15-10-500BD/FF	400v (40A)	15kW (20hp)	500ltr	65 (184ltr/min)	65dB(A)						£6179.99	£7415.99
06537	SIP RS22-10-500BD/FF	400v (50A)	22kW (30hp)	500ltr	106 (3002ltr/min)	71dB(A)						£9399.99	£11279.99

*All noise calculations comply with Acoustic Determination ISO 3744:2010



SIP INDUSTRIAL DIRECT-DRIVE ROTARY SCREW AIR COMPRESSORS WITH DRYERS

Rotary Screw with direct transmission system for increased reliability & machine longevity

Designed for continuous use and arduous operating conditions

Proven technology - guaranteed high efficiency and constant maintained performance

No power transmission loss - 4% advantage compared to belt-driven transmission

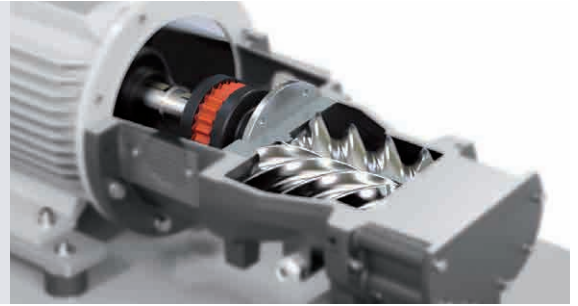

05343

05344



270 LITRE



FULLY AUTOMATIC, INTEGRATED, SELF-MONITORING

05345

05346



500 LITRE



INTELLIGENT MICROPROCESSOR CONTROL SYSTEM



SUPPLIED WITH REFRIGERATED DRYER READY-TO-GO WITH MINIMUM INSTALLATION

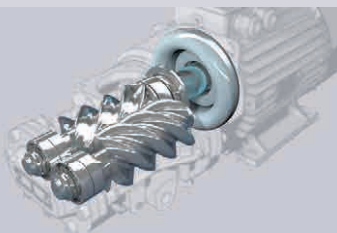

DIRECT-DRIVE TECHNOLOGY FOR MAXIMUM RELIABILITY



100% UK TESTED BEFORE DESPATCH





Item No	MODEL	INPUT	MOTOR (IE3)	RECEIVER SIZE	FREE AIR DELIVERY	MAX. WORKING PRESSURE	NOISE LEVEL	EX. VAT	INC. VAT
05343	SIP RS5.5-10-270DD/RD	400v (20A)	5.5kW (7.5hp)	270ltr	25CFM (705ltr/min)	145psi (10bar)	62dB(A)	£5139.99	£6167.99
05344	SIP RS7.5-10-270DD/RD	400v (32A)	7.5kW (10hp)	270ltr	37CFM (1050ltr/min)	145psi (10bar)	62dB(A)	£5269.99	£6323.99
05345	SIP RS11-10-500DD/RD	400v (40A)	11kW (15hp)	500ltr	55CFM (1565ltr/min)	145psi (10bar)	67dB(A)	£6349.99	£7619.99
05346	SIP RS15-10-500DD/RD	400v (40A)	15kW (20hp)	500ltr	74CFM (2105ltr/min)	145psi (10bar)	67dB(A)	£6559.99	£7871.99

TO PLACE AN ORDER: www.sip-group.com



SIP AIR COMPRESSOR ACCESSORIES

Item No	DESCRIPTION		EX. VAT	INC. VAT
02070	SIP Micro 1/4" Side Regulator (regulator only)	 MADE IN ITALY	£21.79	£26.15
02080	SIP Midi 3/8" Lower Regulator (2 valves)		£35.99	£43.19
02085	SIP Maxi 12 1/2" Lower Regulator (2 valves)		£47.99	£57.59
07526	SIP 1/4" Filter / Regulator (with gauge)		£42.49	£50.99
07528	SIP 1/4" Air Control Unit (filter/regulator/lubricator)		£69.99	£83.99
07531	SIP 1/2" Filter/Regulator (with gauge)		£69.79	£83.75
07532	SIP 1/2" Air Control Unit (filter/regulator/lubricator)		£99.99	£119.99
07561	SIP 1/4" Water Separator		£11.99	£14.39
08299	SIP Particulate & Oil Filtration System (particulate filter / coalescing filter)		£599.99	£719.99

02341	SIP Y Piece - 1/4" Female Coupler		£3.29	£3.95
04075	SIP Display - 1/4" BSP Slimline Silver Female Coupler		£6.59	£7.91
04080	SIP Display - 1/4" BSPT Male Bayonet		£3.29	£3.95
04085	SIP Display - 1/4" BSP Female Bayonet		£3.29	£3.95
04090	SIP Display - 1/4" BSPT Equal Union		£2.19	£2.63
04132	SIP Display - 1/4" Export Universal Female Coupler		£8.79	£10.55
04134	SIP Display - 1/4" Export Universal Male Coupler		£8.79	£10.55
04136	SIP Display - 1/4" BSPT Export Male Bayonet		£3.29	£3.95
04138	SIP Display - 1/4" BSP Export Female Bayonet		£3.29	£3.95
04192	SIP Display - 1/2" BSP Slimline Female Coupler		£10.89	£13.07
04194	SIP Display - 1/2" BSP Slimline Male Coupler		£10.89	£13.07
05096	SIP 1/2" Full Flow Silver Male Bayonet		£5.49	£6.59
05097	SIP 1/2" Full Flow Silver Female Bayonet	£6.59	£7.91	
01605	SIP 1/4" Swivel Connector	£3.29	£3.95	

02313	SIP 4 Way Pressure Switch 1/4" Lower		£29.49	£35.39
02316	SIP 4 Way Pressure Switch 3/8" Lower		£29.49	£35.39
02314	SIP Mignon 1 Way Pressure Switch 1/4" Lower		£29.49	£35.39
02344	SIP TELE 10 Pressure Switch		£108.99	£130.79

02348	SIP Advanced Air Tool Oil - 1ltr		£6.49	£7.79
02350	SIP Trade Advanced Compressor Oil - 1ltr		£8.49	£10.19
02352	SIP Trade Advanced Compressor Oil - 5ltr		£34.99	£41.99
02358	SIP Screw Compressor Oil (3.25kg)		£109.99	£131.99
02419	SIP Advanced Engine Oil (10W40) - 1ltr		£6.99	£8.39
02357A	SIP Anti-Vibration Mounts (sold as singles)		£8.79	£10.55
02359	SIP Heavy-Duty Anti Vibration Mounts (4 pack)		£84.99	£101.99
02068	SIP Wheel Kit/handle to suit 06290 - 150ltr (No reg)		£83.99	£100.79
02069	SIP Wheel Kit/handle to suit 06294 - 200ltr (No reg)	£89.99	£107.99	

07591	SIP 3" Disc for Cut Off Tools (singles)		£4.39	£5.27
17576	SIP 6" Sanding Pad (Vinyl Face) for 06777 & 07211		£7.69	£9.23

SIP TRADE & PROFESSIONAL AIR HOSES

Item No	DESCRIPTION		EX. VAT	INC. VAT
04115	SIP Trade Coiled Air Hose - 5mtr Display Pack (1/4" end fittings)		£7.69	£9.23
07700	SIP Trade 3/8" Workshop Air Hose - 25ft (1/4" end fittings)		£23.99	£28.79
07701	SIP Trade 3/8" Workshop Air Hose - 50ft (1/4" end fittings)		£31.99	£38.39
07703	SIP Trade 3/8" Workshop Air Hose - 10m (1/4" end fittings)		£19.69	£23.63
07431	SIP Professional 3/8" Air Hose - 5mtr (1/4" end fittings)		£18.59	£22.31
07433	SIP Professional 3/8" Air Hose - 10mtr (1/4" end fittings)		£27.29	£32.75
07435	SIP Professional 3/8" Air Hose - 15mtr (1/4" end fittings)		£35.99	£43.19
07437	SIP Professional 3/8" Air Hose - 20mtr (1/4" end fittings)		£45.79	£54.95
07439	SIP Professional 3/8" Air Hose - 50mtr (1/4" end fittings)		£83.99	£100.79

SIP Retractable Electric Cable Reel 15mtr

- Extendable 15mtr lead with high-vis blue flexible cable
- Wall or ceiling-mountable housing with 180° swivel bracket
- Retractable cable reel in hard-wearing polypropylene housing
- Fitted with a 13A UK plug and socket with a 2400w capacity

Item No: 07973
£74.99 EX.VAT
 £89.99 INC.VAT
 13A 230v

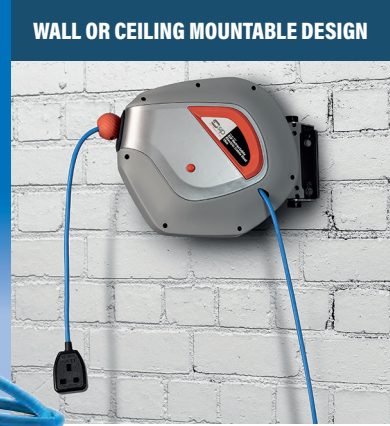

FLOOR-STANDING DESIGN AIR HOSE REELS

Item No	07970	07979
MODEL	SIP Air Hose Reel 20	SIP Air Swivel Hose Reel 30
HOSE LENGTH	20mtr	30mtr
HOSE DIAMETER	8mm	8mm
CONNECTION HOSE LENGTH	1.5mtr	2mtr
MAX. PRESSURE	20bar (300psi)	20bar (300psi)
HOSE FITTINGS	Quick Coupler (Euro)	1/4" BSP (male)
WORKING TEMPERATURE	-5°C to 45°C	-5°C to 45°C
ADDITIONAL FEATURES	CARRY HANDLE THROUGH-FLOW SYSTEM	FOLDING HANDLE METAL CASING 360° ROTATING BASE
EX. VAT	£39.99	£79.99
INC. VAT	£47.99	£95.99

HI-VISIBILITY YELLOW HOSE



WALL-MOUNTED DESIGN

HI-VISIBILITY YELLOW HOSE

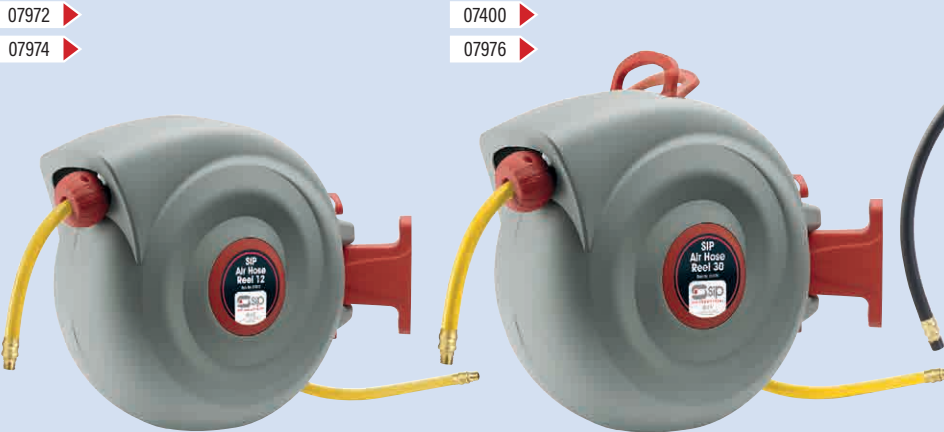

WALL-MOUNTED DESIGN

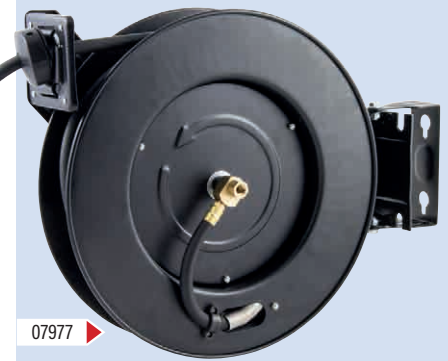

METAL CASING	AUTO LAYER TECHNOLOGY
THROUGH-FLOW SYSTEM	RECOIL HOSE
	FIXED & SWIVEL WALL BRACKET

Item No	07972	07974	07400	07976	07977
MODEL	SIP Air Hose Reel 12	SIP Air Hose Reel 15	SIP Air Hose Reel 20	SIP Air Hose Reel 30	SIP Air Hose Reel R15
HOSE LENGTH	12mtr	15mtr	20mtr	30mtr	15mtr
INSIDE HOSE DIAMETER	9.3mm (3/8")	9.3mm (3/8")	9.3mm (3/8")	9.3mm (3/8")	9.5mm (3/8")
OUTSIDE HOSE DIAMETER	14.5mm (1/4")	14.5mm (9/16")	14.5mm (9/16")	15.3mm (10/16")	14mm (9/16")
CONNECTION HOSE LENGTH	1mtr	1mtr	2mtr	2mtr	1mtr
MAX. PRESSURE	20bar (300psi)	20bar (300psi)	20bar (300psi)	20bar (300psi)	20bar (300psi)
HOSE FITTINGS	Air Coupler	Air Coupler	Air Coupler	Air Coupler	1/4" BSP (male)
WORKING TEMPERATURE	-5°C to 45°C	-5°C to 45°C	-5°C to 45°C	-5°C to 45°C	-5°C to 45°C
EX. VAT	£59.99	£89.99	£119.99	£159.99	£119.99
INC. VAT	£71.99	£107.99	£143.99	£191.99	£143.99

SIP 1/2" Air Impact Wrench - Twin Hammer

- 610Nm (450ft/lbs) average working torque
- 7500rpm speed
- Twin hammer for more power and smooth balanced blows
- 3 forward / 1 reverse torque settings
- Warm touch handle
- Excellent power-to-weight ratio
- 6.5CFM average air consumption
- 90psi (6bar) operating pressure
- 1/4" BSP air inlet



Item No: 07212
£79.99 EXVAT
£95.99 INCVAT

LIGHTWEIGHT
**610NM (450FT/LBS)
TORQUE**
**ADVANCED COMPOSITE
CONSTRUCTION**
WARM-TOUCH HANDLE

SIP 3/4" Air Impact Wrench - Twin Hammer

- 1356Nm (1000ft/lbs) average working torque
- 7000rpm speed
- Twin hammer for more power and smooth balanced blows
- 3 forward / 1 reverse torque settings
- Warm touch handle
- Excellent power-to-weight ratio
- 9.5CFM average air consumption
- 90psi (6bar) operating pressure
- 3/4" BSP air inlet



Item No: 07202
£179.99 EXVAT
£215.99 INCVAT

LIGHTWEIGHT
**1356NM (1000FT/LBS)
TORQUE**
**ADVANCED COMPOSITE
CONSTRUCTION**
WARM-TOUCH HANDLE

SIP 1" Air Impact Wrench Extended Anvil

- 2180Nm (1602ft/lbs) working torque • 4200rpm working speed
- High performance pin-less hammer mechanism • 41mm bolt capacity
- Built-in adjustable speed regulator
- 15CFM av. air consumption
- 1/2" BSP air inlet



Item No: 06795
£249.99 EXVAT
£299.99 INCVAT

SIP 1/2" Air Impact Wrench Kit

- Comprehensive 17-piece kit
- 312Nm (23ft/lbs) working torque
- 4.5CFM average air consumption
- 8500rpm max. speed capacity
- 10 chrome vanadium 1/2" sockets: 9, 10, 11, 13, 14, 17, 19, 22, 24 & 27mm
- 3" extension
- Supplied in blow-moulded carry/storage case



Item No: 06792
£55.99 EXVAT
£67.19 INCVAT

SIP 73 Piece Air Tool Kit

- 1/2" Air Impact Wrench; 230ft/lbs working torque
- 8x 1/2" sockets
- 3" wrench drive extension
- 3/4" Reversible Ratchet; 50ft/lbs working torque
- 3/8" and 1/2" drive socket adaptor; 4x sockets 3/8" screwdriver + 10 screw bits
- Air Die Grinder; 22,000rpm and 10 grinding stones
- 150mm Air Hammer; 4500 blows per/min
- 4x chisels
- Air blow gun; 5x nozzles, 4x bayonets
- Pressure gauge; hex key; PTFE tape
- 1/4" air line coupler and jubilee clip



Item No: 07197
£179.99 EXVAT
£215.99 INCVAT

SIP 1/4" Air Die Grinder

- Compact, lightweight design, high velocity, low vibration grinder
- 22,000rpm speed
- Rubber-coated lightweight aluminium body
- Safety lever prevents accidental starts
- Rear exhaust directs exhaust away from work



Item No: 06713

£27.29 EX.VAT
£32.75 INC.VAT

AS USED BY:
BAD OBSESSION
MOTORSPORT

SIP Air Body Saw

- Ideal for bodyshop repair
- 10,000spm
- Anti-vibration cover - 6CFM av. air consumption
- 1/4" BSP air inlet
- Cutting capacity: 1.2mm 16 gauge (steel) / 1.6mm 14 gauge aluminium



Item No: 01611

£35.99 EX.VAT
£43.19 INC.VAT

SIP Air Nibbler

- 3500spm speed
- 18 gauge (1.2mm) mild steel cutting capacity
- 6CFM average air consumption



Item No: 01616

£42.49 EX.VAT
£50.99 INC.VAT

SIP 6" Air Dual Action Sander

- Random orbit for swirl-free finish - 10,000rpm working speed
- 6" backing pad included - 4CFM av. air consumption
- 90psi (6bar) operating pressure
- 1/4" BSP air inlet



Item No: 01609

£30.59 EX.VAT
£36.71 INC.VAT

SIP 1/2" Reversible Air Ratchet

- 45ft/lbs (61Nm) working torque - 150rpm no-load speed
- 5CFM average air consumption - 1/4" BSP air inlet
- Ball and needle bearing for long service life
- Easy speed control



Item No: 01618

£34.99 EX.VAT
£41.99 INC.VAT

SIP Air Belt Sander

- 18000rpm no load speed - 4CFM average air consumption
- 10 x 330mm belt sander with lever throttle control
- Ideal for a variety of materials including steel, aluminium & plastic
- Adjustable arm with quick belt tensioning lever
- 1/4" BSP air inlet
- 90psi (6bar) operating pressure



Item No: 07401

£43.59 EX.VAT
£52.31 INC.VAT

SIP 6" Air Palm Sander

- Designed for one-handed operation - 10,000rpm working speed
- 6" backing pad included - 2.8CFM av. air consumption
- 90psi (6.3bar) operating pressure
- 1/4" BSP air inlet



Item No: 06777

£53.39 EX.VAT
£64.07 INC.VAT

SIP 4" Air Angle Grinder

- Ideal for clearing, smoothing welds and castings
- 4" disc diameter - 10000rpm no-load speed
- 6CFM av. air consumption - 1/4" BSP air inlet
- 90psi (6bar) operating pressure



Item No: 01617

£54.49 EX.VAT
£65.39 INC.VAT

SIP Pistol Grip Air Needle Scaler

- Ideal for removal of rust and paint
- 4500blows/min
- Pistol grip with rubber handle
- 2.8CFM av. air consumption
- 1/4" BSP air inlet
- 90psi (6.3bar) operating pressure



Item No: 06781

£71.99 EX.VAT
£86.39 INC.VAT

SIP 2-in-1 Air Nailer/Stapler Kit

- 2-in-1 magazine design - 100 nail magazine capacity
- Touch-strike system for extra safety
- Adjustable nail depth
- 60 to 100psi (3 to 7bar) operating pressure



Item No: 06771

£39.99 EX.VAT
£47.99 INC.VAT

SIP Sandblast Cabinet

- Convenient table top design
- 230v (13A) supply
- 7CFM av. air consumption
- One piece seamless construction
- Quick and efficient sandblasting, quickly removes rust, paint and other unwanted debris from metal or wood surfaces
- Automatic air shut-off



Item No: 03868

£129.99 EX.VAT
£155.99 INC.VAT

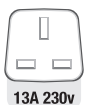

SIP AIR TOOLS

SIP COBALT Trade Spray Gun

- General purpose gravity-fed spray gun with 1.5mm nozzle
- 0.40litre paint capacity
- 4.5 - 6bar (65 - 87psi) operating pressure
- ¼" BSP air inlet
- 6.5CFM average air consumption
- Not suitable for water-based paint



Item No: 02137
£17.49 EX.VAT
£20.99 INC.VAT

SIP COBALT Spray Gun

- Professional gravity-fed spray gun with 1.4mm nozzle
- 0.75ltr paint capacity
- 3 - 4bar (43.5 - 58psi) operating pressure
- ¼" BSP air inlet
- 7CFM av. air consumption



Item No: 02131
£29.49 EX.VAT
£35.39 INC.VAT

SIP DIAMOND Spray Gun

- Professional suction-fed spray gun with 2mm nozzle
- 1ltr paint capacity
- 4.5 - 6bar (65 - 87psi) operating pressure
- ¼" BSP air inlet
- 8.5CFM average air consumption



Item No: 02132
£32.69 EX.VAT
£39.23 INC.VAT

SIP MIRAGE HVLP Spray Gun

- Professional suction-fed spray gun with 1.8mm nozzle
- 1ltr paint capacity
- 2.5 - 3.5bar (36 - 50psi) operating pressure
- ¼" BSP air inlet
- 14.7CFM av. air consumption



Item No: 02136
£32.69 EX.VAT
£39.23 INC.VAT

SIP SAPPHIRE HVLP Spray Gun

- Professional gravity-fed spray gun with 1.4mm nozzle
- 0.6ltr paint capacity
- 3 - 4bar (43.5 - 58psi) operating pressure
- ¼" BSP air inlet
- 6.4CFM av. air consumption



Item No: 02138
£37.99 EX.VAT
£45.59 INC.VAT

SIP 5 Piece Air Kit

- 1.5mm suction spray gun with adjustable fluid/air control
- Inflating gun with rubber-protected gauge and rubber hose
- Degreaser with 1ltr easy clean fluid pot capacity
- Pistol-type duster
- 5m kink-resistant hose, ¼" female connectors



Item No: 04947
£29.99 EX.VAT
£35.99 INC.VAT

SIP 100mm Air Duster Gun SIP 300mm Air Duster Gun

- 100mm (02146), 300mm (02147) nozzle length
- 2 - 4bar (29 - 58psi) pressure
- ¼" BSP air inlet

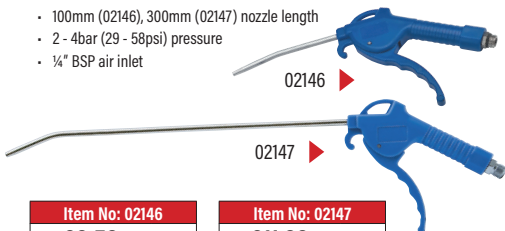

Item No: 02146
£6.59 EX.VAT
£7.91 INC.VAT

Item No: 02147
£11.99 EX.VAT
£14.39 INC.VAT

SIP Air Duster Gun

- A lightweight, general purpose gun for cleaning of dust, swarf, water and more
- Polished gun body with aluminium pot - 50mm nozzle
- Recommended pressure 29 - 87psi (2 - 6bar)
- ¼" BSP male air inlet



Item No: 02139
£8.79 EX.VAT
£10.55 INC.VAT

SIP Air Brush Set

- 0.8mm nozzle - 20ml paint jar capacity
- 15 - 50psi operating pressure
- 1.5mtr hose length with adaptor
- 5mm male air inlet
- 2x paint jars included
- Supplied with storage box



Item No: 01614
£23.99 EX.VAT
£28.79 INC.VAT

SIP Trade Engine Cleaning Gun

- General purpose engine cleaning gun for cleaning, degreasing or can be used as a duster
- Large 950ml container - Recommended pressure 29 - 87psi (2 - 4bar)



Item No: 02143
£11.99 EX.VAT
£14.39 INC.VAT

SIP Air Caulking Gun

- Designed to give fast and even application of sealants and glues, with a release valve giving complete control.
- Takes standard 11oz cartridge (215 x 50mm)
- 6CFM min. air pressure
- Lightweight - just 1.4kg



Item No: 07542
£23.99 EX.VAT
£28.79 INC.VAT

SIP Tyre Inflator

- General purpose tyre inflating gun
- Rubber-protected pressure gauge
- ¼" BSP air inlet



Item No: 02142
£18.99 EX.VAT
£22.79 INC.VAT

SIP Maxi-Flate Tyre Inflator

- Professional inflating gun
- WIKA gauge reading bar/psi
- Shock-resistant dial rubber casing
- 1mtr heavy-duty hose
- ¼" BSP air inlet



Item No: 02145
£59.99 EX.VAT
£71.99 INC.VAT

SIP Professional Calibrated Tyre Inflator

- Gauge calibration specification UNI EN 12645
- Max. pressure 174psi (12bar)
- WIKA gauge reading bar/psi
- Shock-resistant dial rubber casing
- 73mm gauge diameter
- 1mtr heavy-duty hose
- ¼" BSP air inlet



WIKI GAUGE READING BAR/PSI



Item No: 02169
£79.99 EX.VAT
£95.99 INC.VAT

1 Ton Folding Engine Crane

- 1 Ton maximum capacity
- Heavy gauge, square tube steel
- 2-speed hydraulic pump with chrome-plated ram
- Dead man's controls
- Fine adjustment lowering handle
- Nylon wheels avoid floor damage
- Unique supporting baseplate wheels
- Arm has 3 pre-set positions: 1,000kg / 750kg / 500kg
- Hook with bearing
- WINNTEC 3 Year warranty



CRANE FOLDS FOR EASY & CONVENIENT STORAGE

90MM HEIGHT LOW-PROFILE LEG DESIGN; FOR EASY POSITIONING UNDER LOW VEHICLES

ENGINE CRANE
No: 09808 (Y440104)
£599.99 EX.VAT
£719.99 INC.VAT



Engine Leveller

- 550kg max. weight capacity
- Suitable for all Winntec cranes
- Durable drop-forged steel frame
- Reliable long-lasting performance
- Full adjustment via threaded rod
- 2x 100cm heat-treated chains
- WINNTEC 3 Year warranty



No: 09807 (Y440105)
£66.99 EX.VAT
£80.39 INC.VAT

3 Ton / 6 Ton Pin Type Jack Stands

- Supplied in pairs
- Pin-type support column
- Adjusts to multiple heights
- Lift height range:
322 - 465mm (3 Ton)
404 - 604mm (6 Ton)
- WINNTEC 3 Year warranty



3 TON
No: 09847 (Y452300)
£59.99 EX.VAT
£71.99 INC.VAT

6 TON
No: 09849 (Y452600)
£119.99 EX.VAT
£143.99 INC.VAT

12 Ton Trolley Jack Stands

- 12 Ton lifting capacity - 302 - 450mm lifting height
- 22cm square base for added stability
- Wheel-mounted for easy movement
- Pin-type support column adjusts to five different height positions
- Supplied in pairs
- WINNTEC 3 Year warranty



No: 09846 (Y451205)
£214.99 EX.VAT
£257.99 INC.VAT



12 Ton High-Reach Trolley Jack Stand

- Supplied in singles
- Pin-type support column
- Multi-angle handle socket and wheels for easy positioning under vehicles
- Adjusts to multiple heights
- Lift height range: 601 - 971mm
- Weight 29.2kg
- WINNTEC 3 Year warranty



No: 09704 (Y451206)
£249.99 EX.VAT
£299.99 INC.VAT



Air Hydraulic Pump

- 700bar (10,000psi) capacity
- 6 - 10bar working pressure
- 1600cc effective working oil capacity
- Aluminium hydraulic pump housing
- Suitable for rams, presses, hydraulics
- Integrated internal release valve
- Two-stage release mechanism
- 1/4" air inlet and 3/8" air outlet
- Air exhaust muffler
- WINNTEC 3 Year warranty



No: 09831 (Y471150)
£399.99 EX.VAT
£479.99 INC.VAT



Hose Assembly for 09831

- Ultra-strong all metal connectors
- High-strength hosing for durability
- WINNTEC 3 Year warranty



No: 09877 (Y478205)
£83.99 EX.VAT
£100.79 INC.VAT



Trolley Jacks

Our WINNTEC from SIP Trolley Jacks are highly manoeuvrable and lightweight in build, which, when combined with excellent stability, provide powerful and reliable lifting under load.



WINNTEC from SIP

TO PLACE AN ORDER: ☎ 01509 500500

Item No	09804 (Y411350)	09701 (Y420250)	09702 (Y420330)	09706 (Y420333)	09705 (Y420222)
MODEL	1.35 Ton Aluminium Racing Trolley Jack Nylon Wheels	2 Ton Low-Profile Turbo-Lift Trolley Jack PU Wheels	3 Ton Turbo-Lift Trolley Jack PU Wheels	3 Ton Low-Profile Turbo-Lift Trolley Jack PU Wheels	2 Ton Low-Profile Turbo-Lift Trolley Jack with Integrated Stand System
LIFTING HEIGHT	80 - 375mm	75 - 510mm	120 - 450mm	76 - 503mm	75 - 500mm
WEIGHT	10.7kg	32kg	32kg	37.5kg	37.5kg
USAGE					
ADDITIONAL FEATURES	ALL-ALUMINIUM CONSTRUCTION UNIVERSAL JOINT SINGLE PUMP SYSTEM CHROME-PLATED PUMP PISTON 100MM RUBBER SADDLE PAD SIDE CARRY HANDLE NON-MARKING NYLON WHEELS WINNTEC 3 YEAR WARRANTY	ULTRA-LOW-PROFILE DESIGN UNIQUE WINNTEC 'TURBO-LIFT' SYSTEM UNIVERSAL JOINT RELEASE MECHANISM DUAL-PUMP PISTONS POLYURETHANE WHEELS CHROME-PLATED MAIN RAM WINNTEC 3 YEAR WARRANTY	UNIQUE WINNTEC 'TURBO-LIFT' SYSTEM UNIVERSAL JOINT RELEASE MECHANISM DUAL-PUMP PISTONS POLYURETHANE WHEELS CHROME-PLATED MAIN RAM WINNTEC 3 YEAR WARRANTY	ULTRA-LOW-PROFILE DESIGN UNIQUE WINNTEC 'TURBO-LIFT' SYSTEM 2-SPEED (FAST & SLOW) CONTROLLED DESCENT DUAL-PUMP PISTONS POLYURETHANE WHEELS CHROME-PLATED MAIN RAM WINNTEC 3 YEAR WARRANTY	ULTRA-LOW-PROFILE DESIGN INTEGRATED AUTO-LOCK STAND SYSTEM LOCKS-IN @ 390MM FOR ULTIMATE OPERATOR SAFETY AND CONTROL UNIQUE WINNTEC 'TURBO-LIFT' SYSTEM 2-SPEED (FAST & SLOW) CONTROLLED DESCENT DUAL-PUMP PISTONS POLYURETHANE WHEELS CHROME-PLATED MAIN RAM WINNTEC 3 YEAR WARRANTY
EX. VAT	£199.99	£199.99	£199.99	£249.99	£299.99
INC. VAT	£239.99	£239.99	£239.99	£299.99	£359.99

Long Chassis Jacks

- Foot-operated pump for efficient lifting
- Swivel castors for easy movement
- Automatic overload safety valve
- Universal joint release valve
- Integrated load control knob
- Steel wheels
- WINNTEC 3 Year warranty



09886

Item No	09885 (Y420500)	09886 (Y421000)
MODEL	5 Ton Chassis Jack	10 Ton Chassis Jack
LIFTING HEIGHT	150 - 680mm	160 - 680mm
WEIGHT	90kg	134kg
USAGE		
EX. VAT	£699.99	£999.99
INC. VAT	£839.99	£1199.99

20 Ton Air Bottle Jack

- 20 Ton weight capacity
- 245mm min. jack height
- 470mm max. jack height
- 225mm lifting height range
- 80mm adjustable height
- Aluminium air motor
- Integrated manual pump
- Polished main ram
- WINNTEC 3 Year warranty



No: 09827 (Y432020)

£279.99 EX.VAT
£335.99 INC.VAT



20 Ton Wheel-Mounted Air Bottle Jack

- 20 Ton weight capacity
- 253mm minimum jack height
- 480mm maximum jack height
- 227mm lifting height range
- 80mm adjustable height
- Integrated manual pump
- Aluminium air motor
- Polished main ram
- Trolley design
- WINNTEC 3 Year warranty



No: 09844 (Y432003)

£359.99 EX.VAT
£431.99 INC.VAT



20 Ton Low-Profile Air Bottle Jack

- 20 Ton weight capacity
- 148mm min. jack height
- 260mm max. jack height
- 112mm lifting height range
- 45mm adjustable height
- Aluminium air motor
- Integrated manual pump
- Polished main ram
- WINNTEC 3 Year warranty



No: 09829 (Y432021)

£279.99 EX.VAT
£335.99 INC.VAT



Automotive & Commercial Vehicle Bottle Jacks

Can be used horizontally and vertically
Solid chrome pump linkage
Overload protection
Polished main ram
Cast iron bases
WINNTEC 3 Year warranty



Item No	09843 (Y411200)	09818 (Y412000)	09820 (Y413000)	09865 (Y411000)	09833 (Y412001)
MODEL	12 Ton Bottle Jack	20 Ton Bottle Jack	30 Ton Bottle Jack	10 Ton Low-Profile Bottle Jack	20 Ton Low-Profile Bottle Jack
LIFTING HEIGHT	214 - 399mm	244 - 449mm	285 - 465mm	120 - 260mm	190 - 340mm
SCREW EXTENSION	60mm	60mm	-	45mm & 6mm	60mm
WEIGHT	7.2kg	10.5kg	14.6kg	6.6kg	9kg
USAGE					
EX. VAT	£66.99	£89.99	£119.99	£119.99	£129.99
INC. VAT	£80.39	£107.99	£143.99	£143.99	£155.99

24 Ton Air Service Jack

- 24 Ton max. weight capacity
- 141mm to 441mm lifting height range
- 3 extensions; 20mm, 50mm, and 100mm
- 1-stage heavy-duty hydraulic lifting system
- Hydraulically-assisted components allow the jack to ascend/descend with air
- Built-in dead-man controls
- Heavy-duty hard chromed piston and ram
- WINNTEC 3 Year warranty



No: 09890 (Y432024)

£899.99 EX.VAT
£1079.99 INC.VAT



32/16 Ton Telescopic Air Service Jack

- 32 / 16 Ton max. weight capacity
- 150mm to 289mm lifting height range
- 2 extensions supplied; 45mm and 100mm
- Dual-stage telescopic hydraulic lifting system
- Hydraulically-assisted components allow the jack to ascend/descend with air
- Built-in dead-man controls
- Heavy-duty hard chromed piston and ram
- Optional 260mm extension sold separately
- WINNTEC 3 Year warranty



No: 09893 (Y432032)

£1049.99 EX.VAT
£1259.99 INC.VAT



Item No	TROLLEY JACK ACCESSORIES	EX. VAT	INC. VAT
HY01-00456	Replacement Saddle Pad (For 09804)	£16.39	£19.67
HY01-00472	Replacement Saddle Pad (For 09706, 09701)	£23.99	£28.79
HY01-00460	Replacement Saddle Pad (For 09816)	£21.79	£26.15
HY03-00005	Replacement Steel Wheel Set (For 09706, 09701)	£49.99	£59.99

Smart Tyre & Wheel Cart

- High-quality construction
- Patented tilting system
- Push-Slide secure locking
- Non-marking durable wheels with industrial bearings
- Powder-coated steel frame
- Weighs only 20kg
- Supports 14" to 20" wheels
- Extender kit available
- WINNTEC 3 Year warranty



No: 09824 (Y471147)

£249.99 EX.VAT

£299.99 INC.VAT

**PUSH-SLIDE SECURE
LOCKING SYSTEM**



Hydraulic Truck Wheel Dolly

- 150kg weight capacity • 680mm dolly frame width
- 470mm dolly frame depth • 280mm dolly frame height
- Carry handle and belt • Compact hydraulic unit for positioning
- Shock-absorbing castors • Frame allows for short working distance
- Ergonomic design • Ideal for emergency road assistance work
- Lightweight and portable
- WINNTEC 3 Year warranty



No: 09871 (Y471106)

£419.99 EX.VAT

£503.99 INC.VAT

**COMPACT & MOBILE
DESIGN**



AS USED BY
BAD OBSESSION
MOTORSPORT

10 Ton Body Repair Kit

- For autobody repair work up to 10 Ton
- 4 extension tubes; 100 / 150 / 300 / 400mm
- 1-speed hand pump; cylinder with 150mm stroke
- Hose, ram flat base, and spreader bits included
- Tube coupling, ram toe, serrated saddle, flex head, plunger toe, 90° wedge head components supplied
- Cast attachments and snap-together pipework for further compatibility with other leading brands
- Heavy-duty chromed ram and pistons
- Supplied in a heavy-duty storage case
- WINNTEC 3 year warranty



No: 09878 (Y444100)

£384.99 EX.VAT

£461.99 INC.VAT



Manual Wheel Dolly

- Heavy-duty industrial wheel dolly
- Capable of moving up to 220kg
- Fast & efficient way to remove wheels
- Ergonomics reduce strain and prevent injury
- Extended rollers are ideal for wide base tyres
- Rollers can have 3 positions for different wheels
- Rubber wheels with unique steel core
- Industrial bearings, Japanese origin
- Optimal lifetime performance
- Quick detach handle
- WINNTEC 3 Year warranty



No: 09832 (Y471105)

£169.99 EX.VAT

£203.99 INC.VAT



WINNTEC from SIP

TO PLACE AN ORDER: ☎ 01509 500500

SIP 2.5 Ton Aluminium/Steel Low-Profile Trolley Jack

- Dual piston pump for increased efficiency and durability
- 'Quick-Lift' system raises saddle to vehicle lifting point
- Durable aluminium & steel construction for added reliability
- 95 - 470mm lifting height range
- Extra-large saddle with rubber pad
- 2-piece handle with rubber bumper
- Heavy-duty wheels and castors
- Safety bypass system prevents the jack from overloading



DUAL PISTON PUMP

Item No: 03623
£199.99 EX.VAT
£239.99 INC.VAT

LOW-PROFILE DESIGN

SIP 3 Ton 'Low-Profile' Trolley Jack

- Dual piston pump increased efficiency and durability
- 'Quick-Lift' system raises saddle to vehicle lifting point
- Heavy-duty steel construction for added reliability
- 70 - 508mm lifting height
- Extra-large saddle with rubber pad
- 2-piece handle with rubber grip
- Heavy-duty wheels and castors
- Safety bypass system prevents the jack from overloading



DUAL PISTON PUMP

Item No: 03633
£159.99 EX.VAT
£191.99 INC.VAT

QUICK-LIFT SYSTEM

SIP 5 & 10 Ton Long Floor Jacks

- 'Quick-Lift' pedal gives rapid initial saddle lift to vehicle contact point
- Extra-long handle for easy access under large vehicles
- Rear toe plate for easy positioning
- Release knob
- Handle lock
- Extra-large saddle diameter
- Large diameter wheels



QUICK-LIFT SYSTEM

03642

Item No	03642	03647
MODEL	SIP 5 Ton Floor Jack	SIP 10 Ton Floor Jack
LIFTING CAPACITY	5 Ton	10 Ton
LIFTING HEIGHT	150 - 560mm	160 - 560mm
SADDLE DIAMETER	130mm	150mm
EX. VAT	£619.99	£819.99
INC. VAT	£743.99	£983.99

SIP Transmission Adaptor

- Fully adjustable gearbox support with forward, backward and side-to-side tilt
- For use with: 03871 & 03690 Transmission Jacks

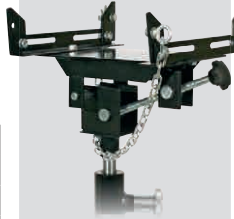

Item No: 03869
£69.99 EX.VAT
£83.99 INC.VAT

SIP 22 Ton Pneumatic Floor Jack

- 22 Ton maximum weight capacity
- 230 - 555mm lift height range
- 115mm screw extension is included
- 9.5CFM maximum air consumption
- 7 to 10bar working air pressure
- Non-marking durable rubber wheels
- Compact and low-profile jack design
- Air-line hook and air control valve
- Handle lock and release control
- Solid and durable construction



22 TON CAPACITY
555MM MAX. LIFT HEIGHT

Item No: 03643
£549.99 EX.VAT
£659.99 INC.VAT

SIP 500KG Transmission Jack

- 1175 - 1995mm lifting height
- Heavy-duty hydraulic cylinder
- Oversized foot pedal for easy lifting
- Knurled air release valve
- Spring-loaded pressure release valve
- New and improved design

PERFECT PARTNERS

Optional Extra - 03869
Transmission Adaptor



Item No: 03871
£249.99 EX.VAT
£299.99 INC.VAT



SIP 500KG 'Quick-Lift' Heavy-Duty Transmission Jack

- Quick-Lift feature - single stroke foot pedal quickly raises cradle to the transmission lifting point
- Heavy-duty base
- 1250 - 2040mm lifting height
- Spring-loaded release valve
- Heavy-duty wheels and castors

PERFECT PARTNERS

Optional Extra - 03869
Transmission Adaptor



Item No: 03690
£299.99 EX.VAT
£359.99 INC.VAT



SIP 1 Ton Heavy-Duty Transmission Jack with Adaptor

- Heavy-duty base
- 1258 - 2145mm lifting height
- Spring-loaded release valve
- Heavy-duty-wheels and castors



FREE TRANSMISSION ADAPTOR INCLUDED
Worth £71.99!

Item No: 03693
£469.99 EX.VAT
£563.99 INC.VAT

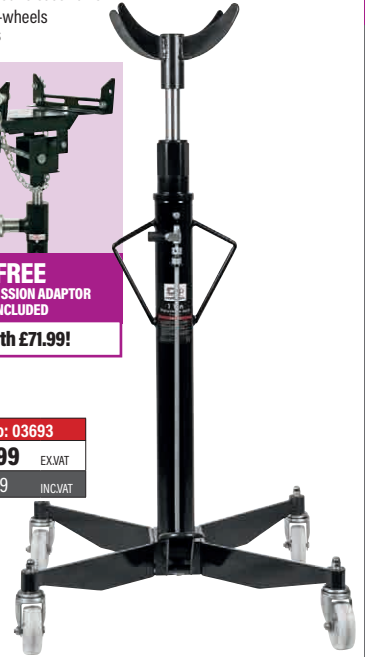

SIP LIFTING / GARAGE EQUIPMENT

SIP Bottle Jacks

A range of powerful and compact bottle jacks with built-in safety valves and serrated saddles for secure contact with load.

Screw extensions for adjustable starting height.

OVERLOAD PROTECTION

CAST IRON BASES



Item No	03667	03656	03658	03660
MODEL	SIP 4 Ton Bottle Jack	SIP 8 Ton Bottle Jack	SIP 12 Ton Bottle Jack	SIP 20 Ton Bottle Jack
LIFTING HEIGHT	183 - 354mm	205 - 400mm	210 - 415mm	242 - 470mm
SCREW EXTENSION	60mm	60mm	60mm	60mm
WEIGHT	3.2kg	5.4kg	72kg	11kg
EX. VAT	£24.99	£35.99	£44.99	£69.99
INC. VAT	£29.99	£43.19	£53.99	£83.99

SIP 3 Ton & 6 Ton Jack Stands

- Lifting height 3 Ton: 310 - 450mm / 6 Ton: 395 - 605mm
- Ratchet action for quick adjustment
- Large feet to spread load
- Supplied in pairs

AS USED BY
BAD OBSESSION
MOTORSPORT



3 TON
Item No: 03637
£37.99 EXVAT
£45.59 INCVAT

6 TON
Item No: 03641
£74.99 EXVAT
£89.99 INCVAT

Item No: 03635
£339.99 EXVAT
£407.99 INCVAT

SIP 6 Ton, 1 Metre Axle Stands

- Lifting height: 540 - 935mm
- Supplied in pairs
- Pin-type support column
- Each stand rated to 6 Tons (12 Tons for the pair)



SIP 24 Litre Air Receiver

- A convenient and portable supply of compressed air
- Ideal for when it is not possible to use an air compressor - just load the receiver and take it with you



Item No: 06298
£79.99 EXVAT
£95.99 INCVAT

SIP 20 Gallon (90Ltr) Parts Washer

- 25w (230v) motor • Self-latching lid with fusible link for safety
- Flexible metal nozzle for precise solvent coverage & filter included
- 136ltr/hr (30 gallons) pumping rate



Item No: 03834
£159.99 EXVAT
£191.99 INCVAT

SIP Parts Washer Solvent 10ltr

- Ideal for use with SIP Parts Washer



Item No: 02382
£44.99 EXVAT
£53.99 INCVAT



SIP Universal Utility Support Stand

- Designed to support components when working under a vehicle
- Fold-up pedal for easier storage
- Slim design ideal for working in tight spaces
- Capacity: 680kg
- Min height: 1365mm
- Max height: 2015mm
- Weight: 17.5kg



Item No: 03629
£129.99 EXVAT
£155.99 INCVAT

SIP Sandblast Cabinet

- Convenient table top design
- 230v (13A) supply
- 7CFM av. air consumption
- One piece seamless construction
- Quick and efficient sandblasting, quickly removes rust, paint and other unwanted debris from metal or wood surfaces
- Automatic air shut-off



Item No: 03868
£129.99 EXVAT
£155.99 INCVAT

13A 230v

SIP Car Creeper

- Durable oil-resistant vinyl cover
- Solid rectangular frame for added strength
- Fully padded back and adjustable angle head rest
- 6 heavy-duty swivel castors for optimum manoeuvrability

AS USED BY
BAD OBSESSION
MOTORSPORT



Item No: 03639
£54.99 EXVAT
£65.99 INCVAT

TO PLACE AN ORDER: ☎ 01509 500500



SIP LIFTING & CRANES

SIP 12 Ton Hydraulic Pipe Bender

- Floor-standing pipe bender with heavy-duty steel chassis
- High-quality 12 Ton hydraulic ram
- Suitable for bending pipe from $\varnothing \frac{1}{2}$ " up to $\varnothing 2$ "
- Supplied with six formers for added versatility
- Former sizes - $\frac{1}{2}$ ", $\frac{3}{4}$ ", 1", $1\frac{1}{4}$ ", $1\frac{1}{2}$ ", 2"
- External return springs



Item No: 03683
£159.99 EX.VAT
£191.99 INC.VAT

INC. 6 FORMERS **12 TON CAPACITY**

SIP 750lbs Engine Stand

- Professional heavy-duty engine stand
- 750lbs capacity
- 360° rotating head to allow access to all parts of the engine
- Fully adjustable mounting arms
- 1x heavy-duty castor and 2x wheels for ease of movement



Item No: 03681
£69.99 EX.VAT
£83.99 INC.VAT

360° ROTATING HEAD

SIP Advanced Hydraulic Oil



Item No: 02347
£7.99 EX.VAT
£9.59 INC.VAT

SIP 10 Ton Auto Body Repair Kit

- Comprehensive kit specifically designed for auto body straightening and alignment
- 700bar pump working pressure
- 520mm max. ram length
- Polished hydraulic ram and cylinder to reduce abrasion
- Built-in safety valve



AS USED BY: **BAD OBSESSION** MOTORSPORT

Item No: 03679
£249.99 EX.VAT
£299.99 INC.VAT

SIP Car Wheel Dollies

- 450kg capacity per dolly
- Supplied in pairs



Item No: 03833
£69.99 EX.VAT
£83.99 INC.VAT

SIP 1 Ton & 2 Ton Foldable Engine Cranes

- Foldable for easy storage
 - 4 hole precision booms
 - 6 wheels for easy movement
- 1 Ton Capacity (03685)**
- 2050mm maximum lift height
 - Lift capabilities: 250 / 500 / 750 / 1000kg
 - 4 Ton ram
- 2 Ton Capacity (03687)**
- 2250mm maximum lift height
 - Lift capabilities: 500 / 1000 / 1500 / 2000kg
 - 8 Ton ram

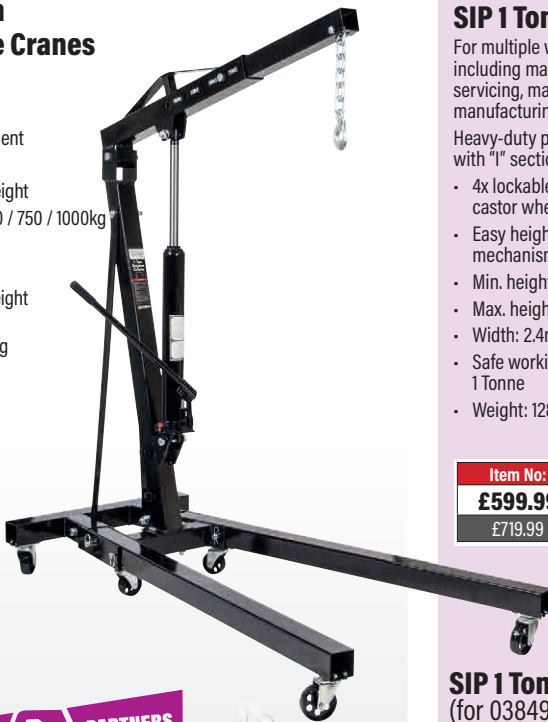

1 TON
Item No: 03685
£219.99 EX.VAT
£263.99 INC.VAT

2 TON
Item No: 03687
£299.99 EX.VAT
£359.99 INC.VAT

PERFECT PARTNERS

Engine Leveller

- Ideal for car, van, truck and marine engines/gearboxes up to 680kg
- Fine screw adjustment levels off centre loads quickly & easily
- Chains supplied
- Can be used with most cranes



ENGINE LEVELLER
Item No: 03692
£49.99 EX.VAT
£59.99 INC.VAT

SIP 1 Tonne Mobile Gantry Crane

For multiple workshop applications including maintenance, repair, servicing, material handling & manufacturing.

Heavy-duty painted steel construction with "I" section crossbeam

- 4x lockable industrial swivel castor wheels
- Easy height adjustable mechanism
- Min. height: 2.4mtr
- Max. height: 3.6mtr
- Width: 2.4mtr
- Safe working load: 1 Tonne
- Weight: 128kg

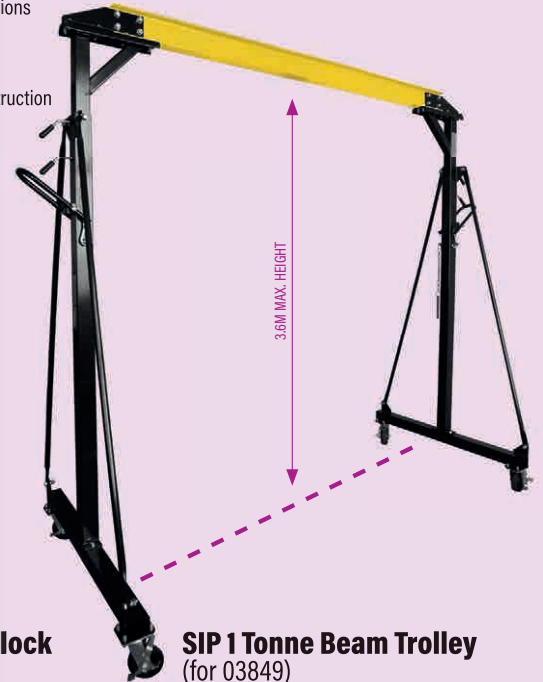

Item No: 03849
£599.99 EX.VAT
£719.99 INC.VAT

SIP 1 Tonne Chain Block (for 03849)

- Chain block assembly with manual chain lift
- Safe working load - 1 Tonne
- Head room- 317mm
- Load chain diameter: 6mm
- Max. hook capacity \varnothing : 40mm
- Weight: 12kg



Item No: 03845
£109.99 EX.VAT
£131.99 INC.VAT

SIP 1 Tonne Beam Trolley (for 03849)

- Sturdy manual 'push-pull' beam trolley. Suitable for "I" section and RSJ beams.
- 4x heavy-duty bearing mounted wheels
- Fitted with wheel guards
- Capacity: 1 Tonne
- Min. "I" beam width: 64mm
- Max. "I" beam width: 140mm
- Weight: 13kg



Item No: 03851
£89.99 EX.VAT
£107.99 INC.VAT

SIP SHOP PRESSES

SIP BENCH AND FLOOR SHOP PRESSES

Ideal for removal or installation of bearings, universal joints, pulleys, wrist pins and various other press jobs.

Perfect for bending, bonding and straightening.

- Rugged steel frames
- Adjustable workbeds
- Glycerine-filled manometers

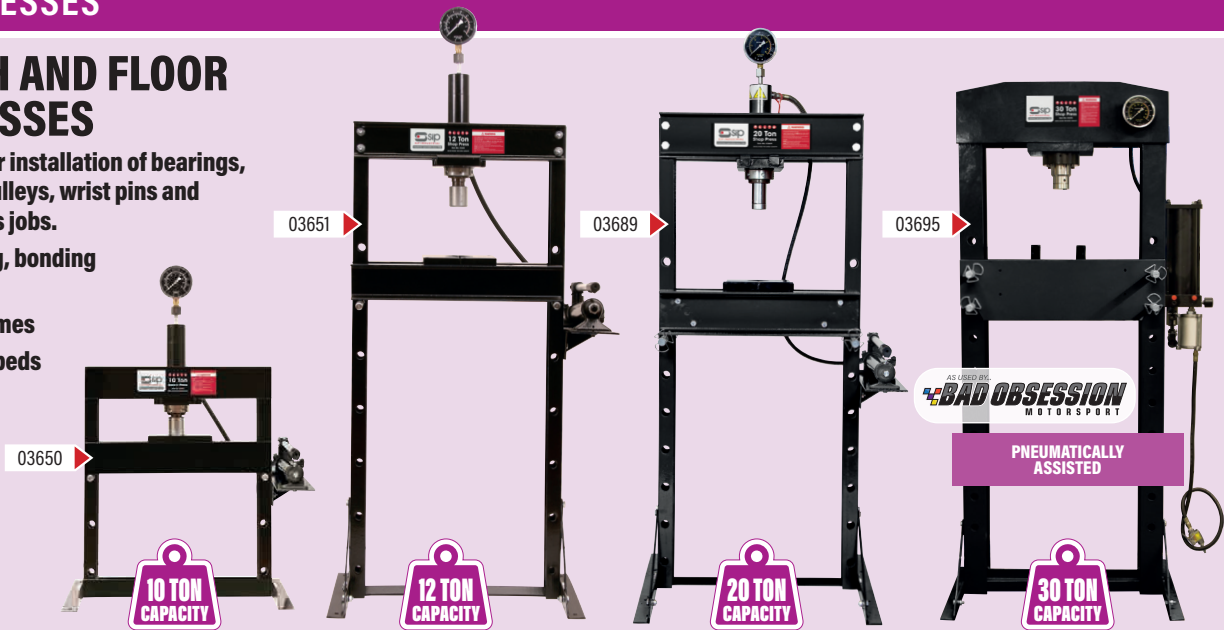

AS USED BY
BAD OBSESSION
MOTORSPORT

PNEUMATICALLY ASSISTED

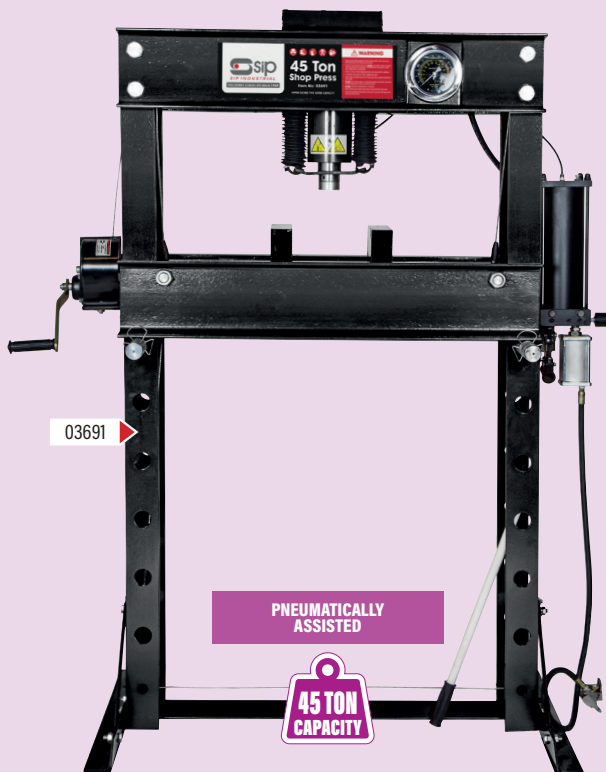

03691

PNEUMATICALLY ASSISTED

45 TON CAPACITY

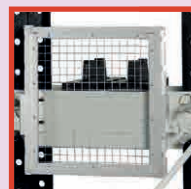

OPTIONAL GUARD AVAILABLE for 03696

Item No: 03631
£134.99 EX.VAT
£161.99 INC.VAT



03696

PNEUMATICALLY ASSISTED

75 TON CAPACITY

SUPPLIED FULLY ASSEMBLED

Item No	03650	03651	03689	03695	03691	03696	03686
MODEL	SIP 10 Ton Bench Press	SIP 12 Ton Shop Press	SIP 20 Ton Shop Press	SIP 30 Ton Shop Press	SIP 45 Ton Shop Press	SIP 75 Ton Shop Press	SIP 100 Ton Shop Press
CAPACITY	10 TON	12 TON	20 TON	30 TON	45 TON	75 TON	100 TON
RAM STROKE	180mm	180mm	185mm	150mm	190mm	250mm	300mm
WORK RANGE	0 - 340mm	0 - 918mm	29.5 - 989.5mm	151 - 1031mm	159 - 859mm	160 - 880mm	93 - 993mm
PRESS TYPE	Bench	Floor	Floor	Floor	Floor	Floor	Floor
OPERATION	Manual	Manual	Manual	Pneumatically-assisted	Pneumatically-assisted	Pneumatically-assisted	Pneumatically-assisted
EX. VAT	£299.99	£399.99	£549.99	£1299.99	£1999.99	£3599.99	£4999.99
INC. VAT	£359.99	£479.99	£659.99	£1559.99	£2399.99	£4319.99	£5999.99

TO PLACE AN ORDER: 01509 500500



SIP 100 TON Shop Press

Heavy-duty 100 ton capacity for industrial applications. Ideal for bending thicker materials and assembling & pressing larger machinery components. Foot-operated press to free both hands for precise workpiece positioning.

HIGH CAPACITY FORCE



100 TON CAPACITY

PNEUMATICALLY ASSISTED

SIP Hydraulic Spring Compressor

Designed with a compact but heavy-duty frame for garages and workshops where floor space is limited.

In comparison to manual compressors, this compressor offers higher efficiency and simpler, safer use thanks to fast one-man operation.

- 1000kg (2204lb) capacity
- 480mm max. working length
- 325mm ram travel
- Use with 4" (101mm) - 10" (254mm) spring size



1000KG CAPACITY

4" - 10" SPRING SIZE

Item No: 03638
£209.99 EX.VAT
 £251.99 INC.VAT

SIP Professional Heavy-Duty Air-Operated Coil Spring Compressor

- 2400kg maximum compression
- 5 - 10bar twin pneumatic rams
- Safety cage inter-lock switch for maximum safety
- Patented coil spring claw designs
- Movable foot plate for positioning
- Retention cable for holding spring
- Steel carabiners for locking cable
- Ideal for cars, SUVs and vans



SUITABLE FOR LARGER SPRINGS CARS, SUVs & VANS ETC.

PATENTED DESIGN



SIP Professional Coil Spring Compressor Universal Top Plate

No need for multiple claws or clamps for different vehicles. With this attachment you can compress almost any coil spring! Optional for use with 03661

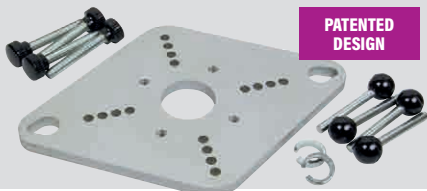

PATENTED DESIGN

Item No: 03663
£299.99 EX.VAT
 £359.99 INC.VAT



Item No: 03661
£2099.99 EX.VAT
 £2519.99 INC.VAT

TO PLACE AN ORDER: www.sip-group.com

SIP INVERTER INDUCTION HEATERS

Perfect for releasing seized fixings, components and parts from vehicles. Also suitable for a variety of manufacturing and heavy-duty processes.

Easy to control and highly efficient, our new range safely reaches temperatures of up to 1000°C in 30 seconds and offer greater levels of safety compared to oxy-acetylene methods.

Features including liquid cooled induction cable and torch maximise product life and ensure user safety.

01156

POWERFUL 1500W MOTOR

13A 230v

4-PIECE INDUCTION KIT
Supplied with a set of multi-use induction tools

(1) Helix Coils:
(xl) 19mm & (xl) 26mm Ø - both 220mm length

(2) Flat Coil:
(xl) 65mm width & 220mm length

(3) Flexi-Induction Lead:
(xl) 800mm length

HOUSED IN A STURDY BLOW MOULDED CARRY/STORAGE CASE

01157

16A 230v

LIQUID COOLED

OPTIONAL
SIP 3 TIER WELDING CART
(05714) SEE PAGE 44

01158

16A 400v

LIQUID COOLED



SIP Induction Heater Coolant

- Specially formulated for use with items 01157 & 01158
- Supplied in 3ltr or 10ltr container



Item No: HY02-00958 - 3L	EX.VAT
£32.99	
INC.VAT	
Item No: HY02-00980 - 10L	EX.VAT
£99.99	
INC.VAT	

Item No	01156	01157	01158
MODEL	SIP 1500W INDUCTION HEATER KIT	SIP 3700W INDUCTION HEATER	SIP 10000W INDUCTION HEATER
INPUT SUPPLY	230v (13A)	230v (16A)	400v 3-Phase
INDUCTION POWER	1.5kW	3.7kW	10kW
POWER STEPS	Fixed	Infinitely Variable	Multi-level
HEAT RANGE	800°C (maximum)	1000°C (maximum)	1000°C (maximum)
INDUCTION CABLE LENGTH	850mm	2mtr	5mtr
POWER CABLE LENGTH	3mtr	3mtr	5mtr
COOLING SYSTEM	Fan Cooled Torch	Liquid Cooled Torch, Induction Cable & Inverter Unit	Liquid Cooled Torch & Induction Cable
COOLANT TANK CAPACITY	n/a	2.5ltr	10ltr
INVERTER VENTILATION	Cooling Fan	Twin Cooling Fans	Six Cooling Fans
EX. VAT	£649.99	£2499.99	£6299.99
INC. VAT	£779.99	£2999.99	£7559.99

SIP INDUCTION HEATER CONSUMABLES

Item No	FOR ITEM: 01156 (1500w)	EX. VAT	INC. VAT	Item No	FOR ITEM: 01157 (3700w)	EX. VAT	INC. VAT
HY02-00931	Induction Flexi Coil - 800mm	£34.99	£41.99	HY02-00943	Pad Coil Holder Extender	£66.99	£80.39
HY02-00936	Induction Coil Straight - 19/220mm	£21.99	£26.39	HY02-00944	Pad Coil Inclined	£279.99	£335.99
HY02-00939	Induction Coil Straight - 26/220mm	£24.99	£29.99	HY02-00945	Pad Coil Flat	£279.99	£335.99
HY02-00942	Induction Coil Straight - 45/220mm	£25.99	£31.19				

TO PLACE AN ORDER: ☎ 01509 500500



**SIP 80 LITRE
GRAVITY
OIL DRAINER**

- Collect waste oil from vehicle gearbox or engine
- 80ltr tank capacity
- 0.7 - 1bar (10 - 15psi) ejection pressure
- 40° - 60°C working temperature (for engine oil)
- 20ltr collect tray capacity
- Oil reservoir level indicator tube
- 1195 - 1810mm height adjustable range
- Wheel and castor-mounted



Item No: 03700
£269.99 EX.VAT
£323.99 INC.VAT

**SIP 80 LITRE
SUCTION / GRAVITY
OIL DRAINER**

- Collect waste oil from vehicle gearbox or engine
- 80ltr tank capacity
- 6 - 10bar (87 - 145psi) suction pressure (extraction)
- 0.7 - 1bar (10 - 15psi) ejection pressure
- 40° - 60°C working temperature (for engine oil)
- 20ltr collector tray capacity
- Oil reservoir level indicator tube
- 1190 - 1810mm height adjustable range
- Wheel and castor-mounted



**6X SUCTION
TUBES
INCLUDED**



Item No: 03711
£359.99 EX.VAT
£431.99 INC.VAT

**SIP 80 LITRE
SUCTION / GRAVITY
OIL DRAINER WITH INSPECTION CHAMBER**

- Collect waste oil from vehicle gearbox or engine
- 80ltr tank capacity
- 11ltr Perspex inspection chamber
- 6 - 10bar (87 - 145psi) suction pressure (extraction)
- 0.7 - 1bar (10 - 15psi) ejection pressure
- 40° - 60°C working temperature (for engine oil)
- 20ltr collector tray capacity
- 1500 - 1810mm height adjustable range
- Wheel and castor-mounted

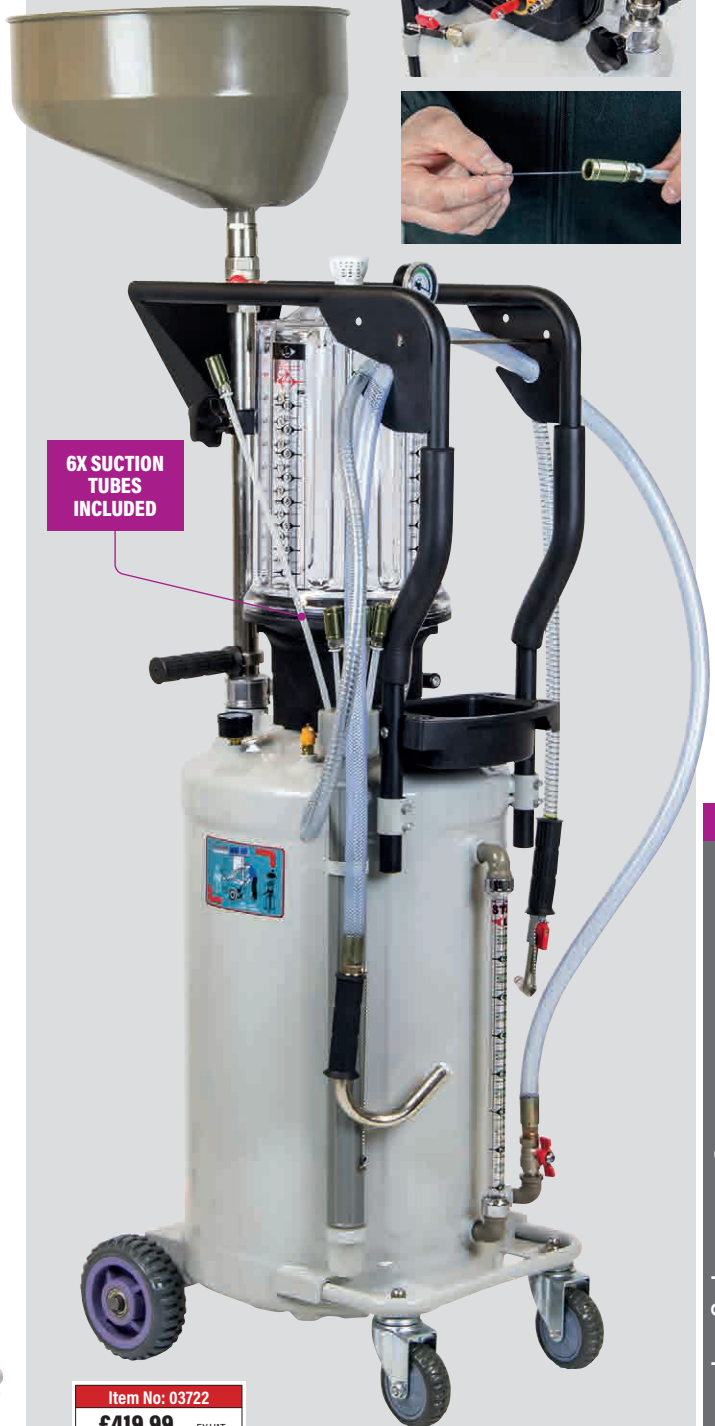

**6X SUCTION
TUBES
INCLUDED**

Item No: 03722
£419.99 EX.VAT
£503.99 INC.VAT

New Extended Range of Diesel Fuel Transfer Pumps

Boost the efficiency of onsite fuelling and maintain accurate records of diesel usage throughout your facility. Using a compact design, SIP's range of diesel fuel pumps easily install onto an existing storage unit for convenient dispensing using either 12v, 24v or 230v power supplies.

PORTABLE DESIGN FOR EASY FUEL TRANSFER

06801 & 06803

- Powerful 12v or 24v DC motor options, with copper-wound armatures for optimum performance
- Compact and lightweight design for portability
- High quality aluminium nozzle ensures strength and durability
- Supplied with non-return valve to aid self-priming
- Built-in bypass valve for start and stop operation
- 2mtr suction hose, 4mtr delivery hose



INTEGRATED HANDLE FOR PORTABILITY



06801
06803



PORTABLE & WALL MOUNTABLE DESIGN

06805 & 06807

- Powerful 12v DC (06805) or 230v AC (06807) motor options, with copper-wound armatures for optimum performance
- Compact design with easy wall-mountable bracket
- Accurate flow meter with 4 digit subtotal and 8 digit grand total display
- Supplied with non-return valve to aid self-priming
- 2mtr suction hose, 4mtr delivery hose



FEATURE INTEGRATED FILLER NOZZLE HOLSTER



WALL MOUNTABLE PROVIDING A MORE PERMANENT FUELLING OPTION



06805



06807



TO PLACE AN ORDER: ☎ 01509 500500

ITEM No.	06801	06803	06805	06807
MODEL	SIP 12v Diesel Transfer Pump	SIP 24v Diesel Transfer Pump	SIP 12v Diesel Transfer Pump with Fuel Meter	SIP 230v Diesel Transfer Pump with Fuel Meter
INPUT VOLTAGE	12v DC	24v DC	12v DC	230v AC
MOTOR POWER	160w	160w	160w	550w
MAX. PUMPING HEAD	10mtr	10mtr	10mtr	15mtr
MAX. FLOW RATE	40ltr/min	40ltr/min	40ltr/min	60ltr/min
SPEED	3200rpm	3200rpm	3200rpm	2850rpm
MAX. WORKING PRESSURE	15psi (1bar)	15psi (1bar)	15psi (1bar)	22psi (1.5bar)
CONNECTION	3/4" BSP	3/4" BSP	3/4" BSP	1" BSP
SUCTION HOSE LENGTH	2mtr	2mtr	2mtr	2mtr
DELIVERY HOSE LENGTH	4mtr	4mtr	4mtr	4mtr
WEIGHT	7.15kg	7.10kg	12.50kg	16.90kg
EX. VAT	£199.99	£199.99	£229.99	£249.99
INC. VAT	£239.99	£239.99	£275.99	£299.99

SIP STARTMASTER P300 STARTER CHARGER

- 230v (13A) input supply
- 12v charging voltage
- 150A max. boost rate
- 150Ah max. battery capacity
- 20A max. charging current
- 2 different charge rate settings
- Ideal for workshops and garages
- Clear and easy-to-read ammeter
- Short circuit/overload protections
- Reverse polarity protection
- **BOOST START - JUMP START YOUR CAR**

05532 ▶



Item No: 05532
£169.99 EX.VAT
 £203.99 INC.VAT



Item No: 05533
£199.99 EX.VAT
 £239.99 INC.VAT

COMPATIBLE WITH

ALL LEAD ACID					

SIP STARTMASTER P440 STARTER CHARGER

- 230v (13A) input supply
- 12v/24v charging voltages
- 220A max. boost rate
- 180Ah max. battery capacity
- 33A max. charging current
- Ideal for workshops and garages
- Clear and easy-to-read ammeter
- Short circuit / overload protections
- 2 different charge rate settings
- **BOOST START - JUMP START YOUR CAR**

05533 ▶



SIP PROFESSIONAL STARTMASTERS

Wheel-mounted professional battery starter/chargers, suitable for professional-grade applications and tradespeople.

Tough, wheel-mounted steel case for added durability.

Supplied with heavy-duty charge leads and crocodile clips.

BOOST START - JUMP START YOUR CAR

05534 ▶



05537 ▶



05539 ▶



ITEM No.	05534	05536	05537	05538	05539
MODEL	SIP STARTMASTER PW520	SIP STARTMASTER PW600	SIP STARTMASTER PW760	SIP STARTMASTER PWT1000	SIP STARTMASTER PWT1400
INPUT SUPPLY	230v 50Hz	230v 50Hz	230v 50Hz	230v 50Hz	230v 50Hz
BATTERY VOLTAGE	12/24v	12/24v	12/24v	12/24v	12/24v
FUNCTIONS	3 Charge Settings & Boost			6 Charge Settings & Boost	
	JUMP START				
START INPUT	5.8kW	6.3kW	8.5kW	11.2kW	15.2kW
RECOMMENDED PLUG (not supplied)	230v (32A)	230v (32A)	230v (32A)	230v (63A)	230v (63A)
MAX. START CURRENT (fully discharged battery)	260A	300A	380A	500A	700A
	CHARGING				
RECOMMENDED PLUG (not supplied)	230v (13A)	230v (13A)	230v (13A)	230v (13A)	230v (13A)
MAX. CHARGING CURRENT	42A (12v) / 21A (24v)	45A (12v) / 22.5A (24v)	57A (12v) / 28.5A (24v)	68A (12v) / 34A (24v)	90A (12v) / 45A (24v)
MAX. BATTERY CAPACITY	200Ah	280Ah	340Ah	370Ah	400Ah
CHARGE USAGE					
EX. VAT	£319.99	£349.99	£419.99	£539.99	£699.99
INC. VAT	£383.99	£419.99	£503.99	£647.99	£839.99

NOTE: No mains plug supplied with these products. Charging & Jump Starting functions have different plug & supply requirements.

SIP DIGITAL BATTERY CHARGERS

SIP CHARGESTAR D15 & D40 DIGITAL BATTERY CHARGERS

Powerful and portable digital battery chargers, designed for charging all types of lead acid batteries. Featuring an intelligent microprocessor with automatic charging cycles, this range makes battery charging easier, faster and safer.

COMPATIBLE WITH	ALL LEAD ACID						CALCIUM	START STOP
	LEAD ACID	SLA	AGM	GEL	WET	VRLA	CaCa	EFB

- Designed for both 12v & 24v Lead Acid batteries
- Battery type auto-detect intelligently recognises 12v or 24v versions
- Powerful and portable solutions, suitable for car and commercial vehicles
- Features microprocessor controlled automatic charging cycles
- Built-in safety & protection features to maximise user safety



03506

03556



TO PLACE AN ORDER: ☎ 01509 500500

ITEM No.	03506	03556
MODEL	SIP CHARGESTAR D15	SIP CHARGESTAR D40
INPUT SUPPLY	220-240v AC, 50-60Hz, 220w MAX.	220-240v AC, 50-60Hz, 750w MAX.
CHARGING VOLTAGE	12v	12v/24v
MAX. CHARGING CURRENT	15A	40A (@12v) / 20A (@24v)
CHARGING STEPS	6	8
BATTERY TYPE AUTO DETECT	x	✓
INTELLIGENT MICROPROCESSOR	✓	✓
ALTERNATOR TEST FUNCTION	x	✓
RECONDITIONED MODE	✓	✓
REVERSE POLARITY PROTECTION	✓	✓
IP RATING	20	20
USAGE		
EX. VAT	£69.99	£139.99
INC. VAT	£83.99	£167.99

SIP STARTMASTER DIGITAL STARTER/CHARGERS

COMPATIBLE WITH	ALL LEAD ACID					CALCIUM	START STOP	LITHIUM
	+	-	+	-	+	-	+	-
	LEAD ACID	SLA	AGM	GEL	WET	VRLA	CaCa	EFB
								LiFePO4

Powerful bench-top and wheel mounted digital starter chargers, designed for charging and boosting both Lead Acid and Lithium-Ion batteries types.

- Low 1v voltage detection - improves likelihood of recovering batteries unwilling to power
- Automatically diagnoses battery condition and voltage before beginning a charging cycle
- Battery type auto-detect intelligently recognises 12v or 24v versions
- Features microprocessor controlled automatic charging cycles
- **ONE PERSON OPERATION** allows for single user engine boost-start



03587



03585



OPTIONAL
SIP 3 TIER CART
(05714) SEE PAGE 44



03584



ITEM No.	03584	03585	03586	03587
MODEL	SIP STARTMASTER DSC200B	SIP STARTMASTER DSC250B	SIP STARTMASTER DSC350B	SIP STARTMASTER DSC600B
INPUT SUPPLY	230v 50Hz	230v 50Hz	230v 50Hz	230v 50Hz
BATTERY VOLTAGE	6v/12v/24v	12v/24v	12v/24v	12v/24v
FUNCTIONS	10 Stage Charging, Boost & Support JUMP START			
START VOLTAGE	> 1V	> 1V	> 1V	> 1V
START INPUT (5sec)	20A (4.5kW)	26A (6kW)	32A (7.5kW)	44A (10kW)
RECOMMENDED PLUG (not supplied)	230v (32A)	230v (32A)	230v (32A)	230v (63A)
MAX. START CURRENT	200A	280A	400A	620A
	CHARGING			
BATTERY TYPES	All 6v/12v/24v Lead-acid 12v 4-cell Lithium-Ion LiFePO4	All 12v/24v Lead-acid 12v 4-cell Lithium-Ion LiFePO4	All 12v/24v Lead-acid 12v 4-cell Lithium-Ion LiFePO4	All 12v/24v Lead-acid 12v 4-cell Lithium-Ion LiFePO4
CHARGING INPUT CONTINUOUS	4A (1000W)	4A (1000W)	5A (1400W)	8A (2000W)
RECOMMENDED PLUG (not supplied)	230v (13A)	230v (13A)	230v (13A)	230v (13A)
CHARGING CURRENT	5A (6v) / 10A (12v) / 10A (24v)	5A - 15A (12v & 24v)	5A - 20A (12v & 24v)	10A - 30A (12v & 24v)
BOOST CHARGING CURRENT (5min max.)	25A (6v) / 25A (12v) / 20A (24v)	25A	35A	50A
BATTERY CAPACITY	350Ah	350Ah	350Ah	550Ah
CHARGE USAGE				
EX. VAT	£189.99	£299.99	£349.99	£499.99
INC. VAT	£227.99	£359.99	£419.99	£599.99

NOTE: No mains plug supplied with these products. Charging & Jump Starting functions have different plug & supply requirements.

SIP BATTERY CHARGERS

COMPATIBLE WITH	ALL LEAD ACID					
	LEAD ACID	SLA	AGM	GEL	WET	VRLA

SIP CHARGESTAR Smart 18 Battery Charger & Maintainer

- 230v (13A) input supply
- 3-stage charge programme: WET, AGM and GEL batteries
- 6v / 12v charging voltages
- 40 to 160Ah rated battery capacity
- 100% rated output
- Fast / deep charge mode
- 12A max. charging current
- Overcharge / short circuit protection



03981

Item No: 03981
£59.99 EXVAT
 £71.99 INCVAT



COMPATIBLE WITH	ALL LEAD ACID						CALCIUM
	LEAD ACID	SLA	AGM	GEL	WET	VRLA	CaCa

SIP CHARGESTAR 2DV Multi-Stage Charger

- 230v (13A) input supply
- 40w power
- 6v / 12v charging voltages
- 2A max. rated voltage
- 1.2 - 14Ah @ 6v / 1.2Ah - 100Ah 12v
- 7-stage charging cycle
- IP65 rating
- 3x adaptor leads
- Reverse polarity protection



03551



Item No: 03551
£49.99 EXVAT
 £59.99 INCVAT



SIP CHARGESTAR P24 & P32 Battery Chargers

- 230v (13A) input supply
- 12v / 24v dual charging voltage
- 85Ah (05530 - P24) / 110Ah (05531 - P32) max. rated battery capacity
- 2 powerful charging rate settings
- 8.5A rated output / 12.5A max. rated output (05530 - P24)
- 11A rated output / 16A max. rated output (05531 - P32)
- Heavy-duty charge leads and clips
- Reliable reverse polarity protection
- Integrated ammeter for clear levels
- Perfect for garages and workshops



05531

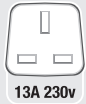

Item No: 05530
£99.99 EXVAT
 £119.99 INCVAT

Item No: 05531
£129.99 EXVAT
 £155.99 INCVAT

SIP BATTERY TESTER

SIP Battery Tester T11 12/24v with Printer

- 12v car & motorcycle batteries
- 12v / 24v starter tests
- 12v / 24v alternator tests
- 12v mass ground tests
- Memory saving
- LCD screen & touchpad
- Premium carry case



Item No: 03568
£319.99 EXVAT
 £383.99 INCVAT



COMPATIBLE WITH	ALL LEAD ACID						CALCIUM	START STOP
	LEAD ACID	SLA	AGM	GEL	WET	VRLA	CaCa	EFB

SIP Barcode Scanner

- Plugs into SIP Battery Tester T11
- Scan barcodes to print them directly to receipts



Item No: 03570
£84.99 EXVAT
 £101.99 INCVAT



GX ADVANCED BATTERY CHARGERS

The GX is the ultimate battery charging, support and diagnostic tool. Combine intelligent charging, maintenance, supply, reconditioning and testing into one simple process with these easy-to-use wall-mountable Advanced Battery Chargers.

COMPATIBLE WITH	ALL LEAD ACID					CALCIUM	START STOP	LITHIUM
	+	-	+	-	+	+	+	+
	LEAD ACID	SLA	AGM	GEL	WET	CaCa	EFB	LiFePO4

- CHARGER FEATURES**
- MULTI-STEP MICROPROCESSOR CONTROLLED CHARGING
- AUTOMATIC MAINTENANCE MODE
- CAN-BUS COMPATIBLE (EXCEPT 03574)
- RECONDITIONED MODE
- SUPPLY MODE
- TEST MODE
- LEAD MODE
- LITHIUM MODE
- EXTENDS BATTERY LIFE
- SPARK PROTECTED
- ENERGY EFFICIENT



DIGITAL INTERFACE CLEAR AND EASY-TO-USE

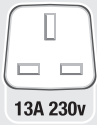

UP TO 10 STAGE CHARGING CYCLE

EASY-TO-USE & WALL-MOUNTABLE



ITEM No.	03572	03573	03574
MODEL	Advanced Battery Charger GX5	Advanced Battery Charger GX10	Advanced Battery Charger GX15
VOLTAGE	12v	12v	12/24v
AMPS	5A	10A	15A
CHARGING STEPS	8	10	10
INPUT VOLTAGE V/Hz	110-240v @ 50-60Hz	230v @ 50-60Hz	230v @ 50-60Hz
CABLE LENGTH	180cm	200cm	200cm
Can-Bus COMPATIBLE	✓	✓	x
RECONDITIONED MODE	✓	✓	✓
ACCESSORIES	Quick connector, clamps, eyelets, 12V DC car adaptor	Quick connector, clamps, eyelets, 12V DC car adaptor	Quick connector, clamps, eyelets
IP RATING	65	65	20
USAGE			
EX. VAT	£59.99	£129.99	£179.99
INC. VAT	£71.99	£155.99	£215.99

TO PLACE AN ORDER: www.sip-group.com

SIP 12V PROFESSIONAL AGM BOOSTER PACKS

AGM (ABSORBENT GLASS MAT) BOOSTER PACKS

ADVANTAGES:

- Purpose-designed & manufactured batteries: high cranking rate
- Robust ABS casing: shockproof
- Quality leads & clamps: increased performance
- Proven technology: reliability
- Reverse polarity alarm: audible alert for workshop environments
- 12V DC power take-off: powers devices direct from the booster

YouTube



SCAN HERE

SIP Rescue Pac 1600

- Rechargeable AGM portable rescue pack for boost starting cars
- 12v DC portable power supply - power devices direct from the booster
- LED charge rate indication
- Rugged, durable design
- 12 month warranty on maintained batteries only



03936

SIP Pro Boosters 2513 & 3100



- Rechargeable AGM portable professional booster for boost starting cars
- 12v DC portable power supply - power devices direct from the booster
- Copper-cored cables and heavy-duty clamps for increased performance
- LED charge rate indication
- Robust ABS casing durable and shockproof
- Supplied with mains charger (07165)
- Supplied with mains FAST charger (07172 & 07173)
- 12 month warranty on maintained batteries only



07172

07173

TO PLACE AN ORDER: 01509 500500

ITEM No.	03936	07172	07173
MODEL	SIP Rescue Pac 1600 12v	SIP Pro Booster 2513 12v	SIP Pro Booster 3100 12v
BOOST PEAK RATE	1600A	2500A	3100A
CRANKING/START RATE	700A	1000A	1170A
BATTERY VOLTAGE	12v	12v	12v
BATTERY CAPACITY	True 22Ah	True 22Ah	True 25Ah
OUTPUT SOCKET	12v DC	12v DC	12v DC
PROTECTION	-	Reverse polarity	Reverse polarity
FREQUENT USAGE WITH			
EX. VAT	£179.99	£319.99	£379.99
INC. VAT	£215.99	£383.99	£455.99

NOTE: ALL AGM PORTABLE RESCUE PACS & BOOSTERS HAVE 12 MONTHS WARRANTY ON MAINTAINED BATTERIES ONLY



SIP 12/24V PROFESSIONAL AGM BOOSTER PACKS

SIP Rescue Pac 3000

- Rechargeable AGM portable rescue pack for boost starting cars & trucks
- 2x 12v DC portable power supply - power devices direct from the booster
- LED charge rate indication
- Rugged, durable design
- Heavy-duty leads and clamps and rear storage hooks



03937



SIP Pro Boosters 5024, 6200 & 6400



- Rechargeable AGM portable professional booster for boost starting cars & trucks
- 12v DC portable power supply - power devices direct from the booster
- Copper-cored cables and heavy-duty clamps for increased performance
- Digital voltmeter
- ON/OFF switch

- Reverse polarity alarm (07192)
- Safety fuse protection
- Robust ABS casing
- Extendible handle and wheels (07178)
- Supplied with mains **FAST** charger



07192



07174



07178

ITEM No.	03937	07192	07174	07178
MODEL	SIP Rescue Pac 3000 12v/24v	SIP Pro Booster 5024 12v/24v	SIP Pro Booster 6200 12v/24v	SIP Pro Booster 6400 12v/24v
BOOST PEAK RATE	3000A (12v) / 1500A (24v)	5000A (12v) / 2500A (24v)	6200A (12v) / 3100A (24v)	6400A (12v) / 3200A (24v)
CRANKING/START RATE	1200A (12v) / 600A (24v)	1680A (12v) / 840A (24v)	1880A (12v) / 940A (24v)	3050A (12v) / 1525A (24v)
INTERNAL BATTERY VOLTAGE	12v / 24v	12v / 24v	12v / 24v	12v / 24v
BATTERY CAPACITY	True 2x 22Ah	True 2x 22Ah	True 2x 25Ah	True 2x 33Ah
OUTPUT SOCKET	2x 12v DC	12v DC	12v DC	12v DC
PROTECTION	Reverse polarity alarm & indication	Reverse polarity alarm & indication	Reverse polarity alarm & indication	Reverse polarity alarm & indication
FREQUENT USAGE WITH				
EX. VAT	£309.99	£829.99	£1069.99	£1199.99
INC. VAT	£371.99	£995.99	£1283.99	£1439.99

NOTE: ALL AGM PORTABLE RESCUE PACS & BOOSTERS HAVE 12 MONTHS WARRANTY ON MAINTAINED BATTERIES ONLY

TO PLACE AN ORDER: www.sip-group.com

SIP PROFESSIONAL HYBRID & CAPACITOR BOOSTER PACKS

HYBRID (AGM/CAPACITOR) BOOSTER PACKS

ADVANTAGES:

- **Hybrid Capacitor / AGM battery design:**
Increased cranking duration via AGM battery - high current capacitor boost
- **Lighter weight:** compared to normal AGM packs (9 - 13kg)
- **Longer AGM battery life:** capacitors provide engine crank - AGM battery charges capacitors
- **Reverse polarity alarm**
- **12V DC power take-off** - powers devices direct from the booster

YouTube



SCAN HERE

SIP SC Pro Hybrid Boosters 3 & 5

- Hybrid Design; Increased cranking duration via AGM battery & high current capacitor boost
- 12v DC portable power supply power devices direct from the booster
- LED charge rate indication
- Heavy-duty cables & clamps
- Lightweight & compact design
- Supplied with fully automatic charger



ITEM No.	07130	07132
MODEL	SIP SC Pro Booster Hybrid 3 12v	SIP SC Pro Booster Hybrid 5 12v
BOOST PEAK RATE	3500A (12v)	3600A (12v)
CRANKING/START RATE	1200A (12v)	1400A (12v)
CAPACITORS	6x 600F Ultra-capacitors	6x 600F Ultra-capacitors
BATTERY CAPACITY	True 15Ah*	True 22Ah*
OUTPUT SOCKET	12v DC	12v DC
PROTECTION	Safety Fuse	Safety Fuse
WEIGHT	9.5kg	13.6kg
FREQUENT USAGE WITH		
EX. VAT	£349.99	£449.99
INC. VAT	£419.99	£539.99

*12 month warranty on AGM battery only

CAPACITOR (ULTRA-CAPACITOR) HAND-HELD BOOSTER PACKS

ADVANTAGES:

- **Lightweight capacitor energy cell**
- **No internal battery: maintenance-free**
- **Ready for use in as little as 140 seconds**



SIP 600A, 1000A & 1600A Capacitor Boosters

- Boost-start small and large engines, including cars, vans, tractors and machinery.
- Uses a lightweight, compact energy cell which offers reliable performance without the weight of a typical battery booster or the need to jump-start from another vehicle battery.
- Easy to use and maintenance-free, they are ready to boost in around two minutes.



ITEM No.	07001	07003	07005
MODEL	SIP 600A 12v Capacitor Booster	SIP 1000A 12v Capacitor Booster	SIP 1600A 12v Capacitor Booster
BOOST PEAK RATE	600A	1000A	1600A
CRANKING/START RATE	300A	500A	800A
INPUT	> 6v DC	> 6v DC	> 6v DC
OUTPUT	12v Engine Start	12v Engine Start	12v Engine Start
CAPACITOR CHARGE TIME (based on 70Ah battery)	60sec	90sec	140sec
WEIGHT	0.68kg	1kg	1.75kg
FREQUENT USAGE WITH			
EX. VAT	£99.99	£139.99	£179.99
INC. VAT	£119.99	£167.99	£215.99

TO PLACE AN ORDER: ☎ 01509 500500



CAPACITOR (ULTRA-CAPACITOR) PRO BOOSTER PACKS

ADVANTAGES:

- High current superconductor design
- No internal battery: maintenance-free
- Fast recharge: 15 seconds from a running vehicle
- Unlimited shelf life
- High quality leads & clamps: for increased performance
- Long product lifespan: over 1 million life cycles
- Lightweight: range from 4 to 20kg



SIP SC Pro Boosters 4000 & 8000 (12v)

- Rechargeable capacitor professional booster high current superconductor design suitable for boosting cars and small vans
- LED charge rate indication
- ON/OFF switch and built-in safety fuse on positive clamp
- Heavy-duty cables & clamps
- Lightweight & compact design
- Supplied with fully automatic charger



07101



07103



SIP SC Pro Boosters 18000 & 18002XP (12/24v)

- Rechargeable capacitor professional booster high current, superconductor design suitable for boosting cars and HGV's
- Digital voltmeter
- ON/OFF switch and built-in safety fuse
- Heavy-duty cables & clamps
- Lightweight & compact design
- Supplied with fully automatic charger
- Extendible handle and wheels (07106)



07107



07106

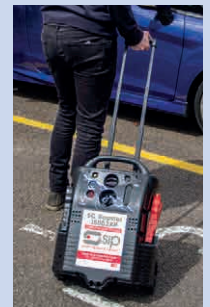

ITEM No.	07101	07103	07107	07106
MODEL	SIP SC Pro Booster 4000 12v	SIP SC Pro Booster 8000 12v	SIP SC Pro Booster 18000 12v/24v	SIP SC Pro Booster 18002XP 12v/24v
BOOST PEAK RATE	4000A	8000A	18000A (12v) / 9000A (24v)	18000A (12v) / 9000A (24v)
CRANKING/START RATE	1200A	1400A	4400A (12v) / 3400A (24v)	4400A (12v) / 3400A (24v)
CAPACITORS	12x 600F Ultra-capacitors	18x 800F Ultra-capacitors	10x 3400F Ultra-capacitors	10x 3400F Ultra-capacitors
PROTECTION	Reverse polarity alarm & indication	Reverse polarity alarm & indication	Reverse polarity alarm & indication	Reverse polarity alarm & indication
WEIGHT	3.8kg	5kg	14.7kg	20.2kg
FREQUENT USAGE WITH				
EX. VAT	£449.99	£579.99	£1149.99	£1249.99
INC. VAT	£539.99	£695.99	£1379.99	£1499.99

SIP INDOOR & OUTDOOR ELECTRIC UNIVERSAL HEATERS

SIP UNIVERSAL HEATER RANGE

Powerful halogen infrared or carbon fibre lamp encased in a strong and lightweight aluminium housing for durability



Uses 30% to 40% less electricity than other traditional heaters

Suitable for indoor or outdoor use

09585, 09586	
STRONG ALUMINIUM HOUSING	GOLD HALOGEN BULBS (HeLeN coated)
IP55 PROTECTED AGAINST LARGE WATER SPLASHES AND DUST	FOR INDOOR & OUTDOOR USE



TELESCOPIC HEIGHT ADJUSTMENT
TRIPOD BASE FOR STABILITY AND SAFETY

09589

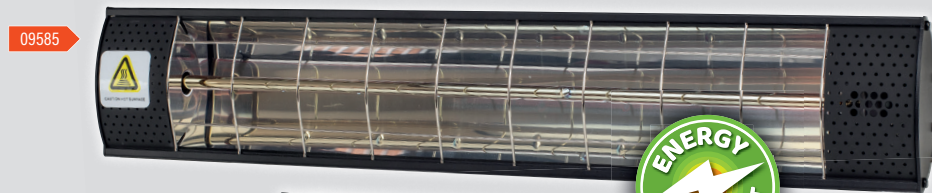

09586



REMOTE CONTROL INCLUDED

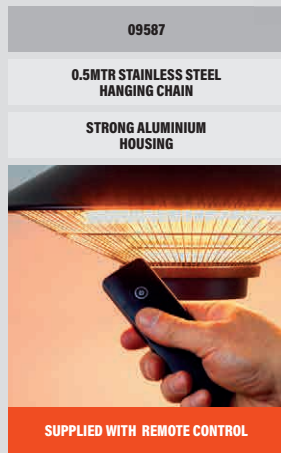

09587

0.5MTR STAINLESS STEEL HANGING CHAIN
STRONG ALUMINIUM HOUSING



SUPPLIED WITH REMOTE CONTROL

09587

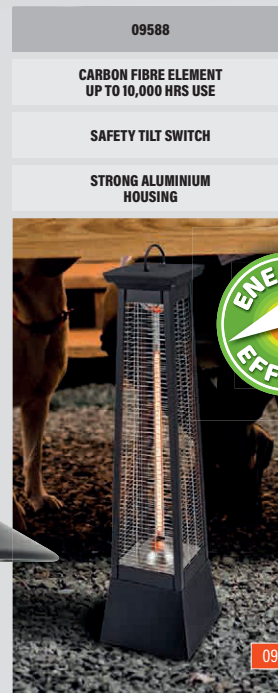

09588

CARBON FIBRE ELEMENT UP TO 10,000 HRS USE
SAFETY TILT SWITCH
STRONG ALUMINIUM HOUSING



800mm HEIGHT

09588

Item No	MODEL	INPUT	HEAT SETTINGS	HEATING OUTPUT	FEATURES	WEIGHT	EX. VAT	INC. VAT	
09585	SIP Halogen Universal Heater	230v (13A)	1	2kW (6,820 BTU/hr)	Wall / Stand Mount	1.7kg	£59.99	£71.99	
09586	SIP Halogen Universal Heater with Remote Control	230v (13A)	2	1kW (3,412 BTU/hr) 2kW (6,820 BTU/hr)	Wall / Stand Mount	1.7kg	£79.99	£95.99	
09589	SIP Halogen Universal Heater Stand	For use with Heaters 09585 & 09586, adjust height position from 1.1mtr to 1.8mtr						£29.99	£35.99
09585P	SIP Halogen Universal Heater + Stand							£79.99	£95.99
09586P	SIP Halogen Universal Heater with remote + Stand							£99.99	£119.99
09587	SIP Hanging Universal Heater with Remote Control	230v (13A)	1	1.5kW (5,118BTU/hr)	Hanging	2.26kg	£89.99	£107.99	
09588	SIP Free-Standing Universal Heater	230v (13A)	1	2kW (6,820BTU/hr)	Floor Standing Carbon Fibre Element	4kg	£139.99	£167.99	

TO PLACE AN ORDER: 01509 500500



SIP CORDLESS PROPANE SPACE HEATERS

18V LITHIUM BATTERY INCLUDED
 SPARE BATTERY AVAILABLE
 ITEM NO: PW25-00013



Ideal for garages, workshops and on-site use

Compact, lightweight & portable



09279



09269



MAINS CHARGER INCLUDED



REGULATOR & HOSE INCLUDED
 NO ADDED EXPENSE!



Item No	MODEL	FUEL	BATTERY	HEAT OUTPUT	HEATING AREA	FUEL USAGE	RUNTIME*	EX. VAT	INC. VAT
09269	SIP FIREBALL 515 Cordless	Propane	18v DC 5.2Ah	51,182 BTU/hr (15kW)	345m ³ (12,181ft ³)	1.09kg/hr	8hrs	£189.99	£227.99
09279	SIP FIREBALL 1050 Cordless	Propane	18v DC 5.2Ah	102,387 BTU/hr (30kW)	500m ³ (17,401ft ³)	2.18kg/hr	6hrs	£229.99	£275.99

*based on a single charge

SPARE BATTERY

SIP 18V 5.2Ah Lithium Battery Pack

For use with 09267, 09269 & 09279 Fireball Cordless Propane Heaters



Item No: PW25-00013
£83.99 EX.VAT
 £100.79 INC.VAT

SIP ELECTRIC PROPANE SPACE HEATERS

Ideal for garages & medium sized workshops



LIGHTWEIGHT WITH CARRY HANDLE HIGHLY PORTABLE

INTEGRATED FRONT SAFETY GRILLE OPERATOR SAFETY IN MIND

HEAVY-DUTY POWDER-COATED FINISH FOR DURABILITY AND LONGER LIFE

IGNITER FOR RAPID STARTING

GAS VALVE

REGULATOR & HOSE INCLUDED
 NO ADDED EXPENSE!



09291



09287

09288

09289

Item No	MODEL	FUEL	INPUT	HEAT OUTPUT	HEATING AREA	FUEL USAGE	WEIGHT	EX. VAT	INC. VAT
09287	SIP FIREBALL 342	Propane	230v (13A)	34,121 BTU/hr (10kW)	230m ³ (8,122ft ³)	0.73kg/hr	3.8kg	£109.99	£131.99
09288	SIP FIREBALL 512	Propane	230v (13A)	51,182 BTU/hr (15kW)	345m ³ (12,181ft ³)	1.09kg/hr	3.8kg	£124.99	£149.99
09289	SIP FIREBALL 1030	Propane	230v (13A)	102,364 BTU/hr (30kW)	690m ³ (24,367ft ³)	2.18kg/hr	5.8kg	£174.99	£209.99
09291	SIP FIREBALL 1706	Propane	230v (13A)	170,607 BTU/hr (50kW)	1145m ³ (40,435ft ³)	3.63kg/hr	7kg	£217.99	£261.59

TO PLACE AN ORDER: www.sip-group.com

SIP ELECTRIC PROPANE HEATERS



Lightweight & portable carry handle - highly portable, ideal for site work, garages and medium-sized workshops
Variable output for efficient gas burning - cost saving!

OPTIONAL WHEEL KIT & HANDLE AVAILABLE (09285): allows for multiple units to be stacked; see below for price For use with: 09274, 09275 & 09276	✓
OPTIONAL WHEEL KIT & HANDLE AVAILABLE (09286): allows for multiple units to be stacked; see below for price For use with: 09277	✓
09278: WHEEL KIT & HANDLE INCLUDED	n/a

HEAVY-DUTY CORROSION-RESISTANT STAINLESS STEEL CASING; DURABLE AND LONGER LIFE

FREE-STANDING LEGS FOR STABILITY

INTEGRATED FRONT SAFETY GRILLE OPERATOR SAFETY IN MIND

IGNITER FOR RAPID STARTING

CARRY HANDLE; EASY PORTABILITY

VARIABLE OUTPUT CONTROLLED BY REGULATOR FOR EFFICIENT GAS BURNING

09277



Item No	MODEL	FUEL	INPUT	HEAT OUTPUT	HEATING AREA	FUEL USAGE	WEIGHT	EX. VAT	INC. VAT
09274	SIP FIREBALL 1071DV	Propane	230v / 110v	51,787 - 107,000 BTU/hr (15.2 - 31.4kW)	718m ³ (25,355ft ³)	1 - 2kg/hr	13.1kg	£329.99	£395.99
09275	SIP FIREBALL 1602DV	Propane	230v / 110v	74,202 - 160,000 BTU/hr (21.7 - 46.9kW)	1074m ³ (37,927ft ³)	1.45 - 2.98kg/hr	14.7kg	£399.99	£479.99
09276	SIP FIREBALL 2261DV	Propane	230v / 110v	106,995 - 226,000 BTU/hr (31.4 - 66.2kW)	1517m ³ (53,572ft ³)	2.1 - 4.27kg/hr	172kg	£499.99	£599.99
09277	SIP FIREBALL 2901DV	Propane	230v / 110v	130,277 - 290,000 BTU/hr (38.2 - 85kW)	1946m ³ (68,722ft ³)	2.5 - 5.28kg/hr	19.2kg	£549.99	£659.99
09278	SIP FIREBALL 3711DV	Propane	230v / 110v	158,767 - 371,000 BTU/hr (46.5 - 108.7kW)	2490m ³ (87,934ft ³)	3.09 - 6.89kg/hr	28.5kg	£799.99	£959.99
09285	SIP FIREBALL WHEEL KIT		For use with 09274, 09275 & 09276					£64.99	£77.99
09286	SIP FIREBALL WHEEL KIT		For use with 09277					£69.99	£83.99

SIP FIREBALL RADIANT PROPANE HEATERS

Compact and portable infrared heating solutions designed to heat work spaces quickly and effectively. No mains supply needed.

- Push-button Piezo ignition system ensures safe, reliable and easy start-up
- Adjustable gas flow control for optimising heat output (09314 & 09316)
- Tip-over and flame out cut off safety device for added protection
- Easy to move around the work area and store between use
- Regulator & hose included

IDEAL FOR HEATING WORKSHOPS & GARAGE SPACES



09314



09315



09316

Item No	MODEL	FUEL	HEAT OUTPUT	FUEL USAGE	HOSE LENGTH	WHEEL KIT	LOW NOISE	EX. VAT	INC. VAT
09314	SIP FIREBALL RP15 RADIANT	Propane	15,000 BTU/hr (4.7kW)	0.34kg/hr	1.5mtr	-	-	£69.99	£83.99
09315	SIP FIREBALL RP35 RADIANT	Propane	35,000 BTU/hr (10.25kW)	0.74kg/hr	2mtr	✓	✓	£169.99	£203.99
09316	SIP FIREBALL RP125 RADIANT	Propane	125,000 BTU/hr (36.6kW)	2.60kg/hr	3mtr	✓	✓	£259.99	£311.99

TO PLACE AN ORDER: ☎ 01509 500500



SIP ELECTRIC FAN HEATERS



Compact and lightweight - ideal for small workshops, garages and offices



- HEAT OUTPUT SETTING CONTROL
- THERMOSTATICALLY-CONTROLLED; AUTOMATIC CUT OFF; ENERGY-SAVING
- HEAVY-DUTY POWDER-COATED FINISH FOR DURABILITY AND LONGER LIFE
- INTEGRATED LEGS FOR STABILITY
- INTEGRATED CARRY HANDLE; EASY PORTABILITY



PTC ELEMENT (POSITIVE THERMAL COEFFICIENT); FOR SAFER TEMPERATURE CONTROL

Item No	MODEL	INPUT	HEAT OUTPUT	HEAT SETTINGS	TILT ADJUST	WEIGHT	EX. VAT	INC. VAT
09128	SIP FIREBALL Turbofan 2000	230v (13A)	6,820 BTU/hr (2kW)	Fan / 1000w / 2000w	✓	1.7kg	£43.59	£52.31
09215	SIP FIREBALL Turbofan 3001	230v (13A)	9,556 BTU/hr (2.8kW)	Fan / 1400w / 2800w	✓	3.4kg	£69.99	£83.99



Ideal for garages & medium-sized workshops

- 09220
- THERMOSTATICALLY-CONTROLLED; AUTOMATIC CUT OFF; ENERGY-SAVING
- HEAT OUTPUT SETTING CONTROL
- INTEGRATED CARRY HANDLE; EASY PORTABILITY
- PTC ELEMENT (POSITIVE THERMAL COEFFICIENT); FOR SAFER TEMPERATURE CONTROL
- INTEGRATED LEGS FOR STABILITY

- 09293
- THERMOSTATICALLY-CONTROLLED; AUTOMATIC CUT OFF; ENERGY-SAVING
- HEAT OUTPUT SETTING CONTROL
- INTEGRATED LEGS & CARRY HANDLE; EASY PORTABILITY
- ROBUST COILED HEATING ELEMENT
- HEAVY-DUTY POWDER-COATED FINISH FOR DURABILITY AND LONGER LIFE

- 09293
- THERMOSTATICALLY-CONTROLLED; AUTOMATIC CUT OFF; ENERGY-SAVING
- HEAT OUTPUT SETTING CONTROL
- INTEGRATED LEGS & CARRY HANDLE; EASY PORTABILITY
- ROBUST COILED HEATING ELEMENT
- HEAVY-DUTY POWDER-COATED FINISH FOR DURABILITY AND LONGER LIFE



Item No	MODEL	INPUT	HEAT OUTPUT	HEAT SETTINGS	TILT ADJUST	WEIGHT	EX. VAT	INC. VAT
09220	SIP FIREBALL Turbofan 5000	400v - 3ph (16A)	17,064 BTU/hr (5kW)	Fan / 3300w / 5000w	✓	4.3kg	£109.99	£131.99
09299	SIP FIREBALL Turbofan 9001	400v - 3ph (16A)	30,706 BTU/hr (9kW)	Fan / 4500w / 9000w	✓	11.4kg	£184.99	£221.99
09298	SIP FIREBALL Turbofan 15000	400v - 3ph (32A)	51,193 BTU/hr (15kW)	Fan / 5000w / 10,000w / 15,000w	x	14.5kg	£309.99	£371.99

TO PLACE AN ORDER: www.sip-group.com

SIP FIREBALL DIESEL/PARAFFIN & KEROSENE SPACE HEATERS

Built with heavy-duty components to ensure long product life and easy-to-use smart design features

- Powerful heating capacity for effective coverage
- Integrated thermostat delivers flexible temperature control
- Carry handle and wheel mounted options available
- Ideal for heating workshops, garage spaces and warehouse areas



► SIP XD50F, XD75F

- COMPACT FLOOR STANDING DESIGN WITH CARRY HANDLE FOR PORTABILITY
- POWERFUL AIR PUMP FOR EFFICIENT FUEL TRANSFER
- HEAVY-DUTY POWDER-COATED FINISH FOR ADDED DURABILITY
- IDEAL FOR HEATING MEDIUM-SIZED WORKSHOP & GARAGE SPACES**



LED THERMOSTAT CONTROL WITH AUTOMATIC SWITCH OFF. REDUCES WASTED FUEL (ITEM NO: 09590 - 09598)

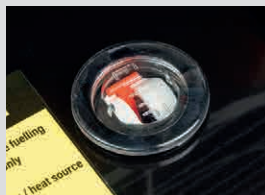

EASY-TO-READ FUEL GAUGE (ITEM NO: 09590 - 09598)

09590
09591



► SIP XD75, XD100

- RUGGED FULL-FRAME DESIGN FOR ADDED PROTECTION
- FITTED WITH HEAVY-DUTY PNEUMATIC TYRES FOR OUTSTANDING MOBILITY
- POWERFUL AIR PUMP FOR EFFICIENT FUEL TRANSFER
- AIR PRESSURE GAUGE INDICATES CONSTANT FUEL SUPPLY
- HEAVY-DUTY POWDER-COATED FINISH FOR ADDED DURABILITY
- IDEAL FOR HEATING MEDIUM-SIZED WORKSHOP & GARAGE SPACES**



AIR PUMP PRESSURE GAUGE (ITEM NO: 09592 - 09596)



09592
09593



Item No	MODEL	FUEL	INPUT	HEAT OUTPUT	HEATING AREA	FUEL USAGE	FUEL TANK	WEIGHT	EX. VAT	INC. VAT
09590	SIP FIREBALL XD50F	Diesel/Paraffin/Kerosene	230v	50,000 BTU/hr (15kW)	350m ³ (12,360ft ³)	1.4ltr/hr	18ltr	16.6kg	£259.99	£311.99
09591	SIP FIREBALL XD75F	Diesel/Paraffin/Kerosene	230v	75,000 BTU/hr (22kW)	530m ³ (18,717ft ³)	1.9ltr/hr	18ltr	16.6kg	£279.99	£335.99
09592	SIP FIREBALL XD75	Diesel/Paraffin/Kerosene	230v	75,000 BTU/hr (22kW)	530m ³ (18,717ft ³)	1.9ltr/hr	26ltr	19.7kg	£299.99	£359.99
09593	SIP FIREBALL XD100	Diesel/Paraffin/Kerosene	230v	100,000 BTU/hr (30kW)	700m ³ (24,720ft ³)	2.8ltr/hr	26ltr	19.7kg	£369.99	£443.99



SIP DIESEL/PARAFFIN/KEROSENE HEATERS

► SIP XD140, XD175, XD215

- RUGGED FULL-FRAME DESIGN FOR ADDED PROTECTION
- FITTED WITH HEAVY-DUTY PNEUMATIC TYRES FOR OUTSTANDING MOBILITY
- POWERFUL AIR PUMP FOR EFFICIENT FUEL TRANSFER
- AIR PRESSURE GAUGE INDICATES CONSTANT FUEL SUPPLY
- REMOTE SENSOR FOR ACCURATE TARGET TEMPERATURE SETTING
- HEAVY-DUTY POWDER-COATED FINISH FOR ADDED DURABILITY
- IDEAL FOR HEATING LARGE-SIZED WORKSHOPS, GARAGE SPACES & WAREHOUSE AREAS**



REMOTE TARGET TEMPERATURE SENSOR (ITEM NO: 09595 - 09598)



- 09594
- 09595
- 09596

► SIP XD275, XD350

- RUGGED FULL-FRAME DESIGN FOR ADDED PROTECTION
- FITTED WITH HEAVY-DUTY PNEUMATIC TYRES FOR OUTSTANDING MOBILITY
- POWERFUL DANFOSS GEAR PUMP FOR EFFICIENT FUEL TRANSFER
- REMOTE SENSOR FOR ACCURATE TARGET TEMPERATURE SETTING
- EXTERNAL FUEL FILTER FOR EASY MAINTENANCE & SERVICING
- HEAVY-DUTY POWDER-COATED FINISH FOR ADDED DURABILITY
- IDEAL FOR HEATING LARGE-SIZED WORKSHOPS, GARAGE SPACES & WAREHOUSE AREAS**



HEAVY-DUTY DANFOSS GEAR PUMP (ITEM NO: 09597 & 09598)



EXTERNAL FUEL FILTER (ITEM NO: 09597 & 09598)

- 09597
- 09598



Item No	MODEL	FUEL	INPUT	HEAT OUTPUT	HEATING AREA	FUEL USAGE	FUEL TANK	WEIGHT	EX. VAT	INC. VAT
09594	SIP FIREBALL XD140	Diesel/Paraffin/Kerosene	230v	140,000 BTU/hr (41kW)	1060m ³ (37,434ft ³)	3.8ltr/hr	65ltr	28.7kg	£399.99	£479.99
09595	SIP FIREBALL XD175	Diesel/Paraffin/Kerosene	230v	175,000 BTU/hr (51kW)	1230m ³ (43,437ft ³)	4.8ltr/hr	65ltr	28.7kg	£449.99	£539.99
09596	SIP FIREBALL XD215	Diesel/Paraffin/Kerosene	230v	215,000 BTU/hr (63kW)	1500m ³ (52,972ft ³)	5.7ltr/hr	65ltr	28.7kg	£499.99	£599.99
09597	SIP FIREBALL XD275 Gear Pump	Diesel/Paraffin/Kerosene	230v	275,000 BTU/hr (80kW)	1930m ³ (68,157ft ³)	7.5ltr/hr	80ltr	38.8kg	£679.99	£815.99
09598	SIP FIREBALL XD350 Gear Pump	Diesel/Paraffin/Kerosene	230v	350,000 BTU/hr (105kW)	2460m ³ (86,874ft ³)	9.5ltr/hr	80ltr	38.8kg	£779.99	£935.99

TO PLACE AN ORDER: www.sip-group.com

SIP PROFESSIONAL DIESEL/PARAFFIN/KEROSENE HEATERS



Highly portable, ideal for garages and medium-sized workshops

OPTIONAL WHEEL KIT AVAILABLE (09001): for 09041 SIP Fireball P660S; see below	✓
WHEEL KIT & HANDLE STANDARD FITMENT (09043 / 09047)	✓

HEAVY-DUTY CORROSION-RESISTANT STAINLESS STEEL CASING; DURABLE FOR LONGER LIFE	WHEEL KIT & HANDLE; EASY PORTABILITY
HEAVY-DUTY AIR PUMP; PROVEN TECHNOLOGY - LOW MAINTENANCE	EXTERNAL FUEL FILTER; FOR EASY MAINTENANCE



DANFOSS FUEL PUMP INSTALLED



REAR CONTROL PANEL WITH ON/OFF SWITCH & CONNECTOR FOR OPTIONAL FIREBALL THERMOSTAT; SEE BELOW

SHOCKPROOF POLYTHENE FUEL TANK; ANTI-CORROSIVE; EXTENDED LIFESPAN

Item No	MODEL	FUEL	INPUT	HEAT OUTPUT	HEATING AREA	FUEL USAGE	FUEL TANK	WEIGHT	EX. VAT	INC. VAT
09041	SIP FIREBALL P660S	Diesel/Paraffin	230v (13A)	73,110 BTU/hr (21.4kW)	461m ³ (16,400ft ³)	2.1ltr/hr	17ltr	20kg	£449.99	£539.99
09043	SIP FIREBALL P1280S	Diesel/Paraffin	230v (13A)	131,512 BTU/hr (38.5kW)	900m ³ (31,143ft ³)	3.81ltr/hr	42ltr	30kg	£669.99	£803.99
09047	SIP FIREBALL P1645S	Diesel/Paraffin	230v (13A)	164,850 BTU/hr (49kW)	1154m ³ (41,214ft ³)	4.81ltr/hr	42ltr	39kg	£799.99	£959.99

SIP Fireball Wheel Kit

For use with SIP P660S heater (09041).



Item No: 09001
£59.99 EX.VAT
£71.99 INC.VAT

SIP Fireball Thermostat

For use with 09043, 09047, 09156 and 09296 SIP Diesel / Paraffin & Infrared Space Heaters



Item No: 09034
£62.99 EX.VAT
£75.59 INC.VAT

10MTR CABLE

TO PLACE AN ORDER: 01509 500500



SIP DIESEL/PARAFFIN/KEROSENE INFRARED HEATERS



Highly portable, ideal for garages and medium-sized workshops

CARRY HANDLE;
EASY PORTABILITY



09311

RAISED RUGGED STEEL FUEL TANK;
FOR ADDED PROTECTION



LED THERMOSTAT CONTROL AND
AUTOMATIC CUT-OFF
(ITEMS: 09311 & 09312)

INFRARED HEATING ELEMENTS;
DIRECT HEATING OF PEOPLE & OBJECTS
FOR EFFICIENT ENERGY USE

HEAVY-DUTY POWDER-COATED FINISH
FOR DURABILITY AND LONGER LIFE

5 LEVELS SAFETY FUNCTION:
TIP-OVER SENSOR,
OVERHEATING PREVENTION SENSOR,
FLAME DETECTOR,
AIR PRESSURE DETECTOR,
MOTOR THERMAL PROTECTOR



09312

RADIANT CONE CAN MOVE
UP AROUND 30°

EASY-TO-READ FUEL GAUGE

RUGGED STEEL FUEL TANK

HANDLE & WHEEL-MOUNTED
FOR EASY MOVEMENT

Item No	MODEL	FUEL	INPUT	HEAT OUTPUT	FUEL USAGE	FUEL TANK	EX. VAT	INC. VAT
09311	SIP FIREBALL 74XRD Infrared	Diesel/Paraffin	230v (13A)	70,000 BTU/hr (20kW)	1.4ltr/hr	12ltr	£449.99	£539.99
09312	SIP FIREBALL 1822 Infrared	Diesel/Paraffin	230v (13A)	120,000 BTU/hr (35.2kW)	3.44ltr/hr	40ltr	£999.99	£1199.99



Highly portable, ideal for garages and medium-sized workshops



09156

PATENTED DESIGN
COMBUSTION CHAMBER

INTEGRATED HEAT DEFLECTOR
MAXIMISES HEAT DISPERSAL



09296

HANDLE & WHEEL-MOUNTED;
FOR EASY MOVEMENT

ADJUSTABLE/FLEXIBLE HEAD;
DIRECT HEATING

INFRARED HEATING ELEMENT;
COST EFFECTIVE DIRECT HEATING
OF PEOPLE AND OBJECTS

POLYTHENE FUEL TANK; ANTI-CORROSIVE;
EXTENDED LIFESPAN

OPTIONAL THERMOSTAT AVAILABLE
FOR 09296, 09156
SEE ITEM: 09034 - PAGE 134



Item No	MODEL	FUEL	INPUT	HEAT OUTPUT	FUEL USAGE	FUEL TANK	EX. VAT	INC. VAT
09296	SIP FIREBALL 1830 Infrared	Diesel/Paraffin	230v (13A)	88,294 BTU/hr (25.8kW)	2.04ltr/hr	43ltr	£1139.99	£1367.99
09156	SIP FIREBALL 1850 Infrared	Diesel/Paraffin	230v (13A)	155,737 BTU/hr (45kW)	3.6ltr/hr	65ltr	£1689.99	£2027.99

TO PLACE AN ORDER: www.sip-group.com

Tigren

EQUIPMENT

- ✓ NO-NONSENSE
- ✓ AFFORDABLE
- ✓ RELIABLE



Robust equipment perfect for workshops, garages and more. Built from quality materials with user-friendly features without compromising TIGREN equipment's no-nonsense approach and affordability.

AIR COMPRESSORS

DIRECT-DRIVE

TIGREN V50DD (04387) / V100DD (04388) 3hp Direct-Drive Oil-Lubricated Compressors

- ✓ 2-cylinder V-configuration splash oil-lubricated pump
- ✓ High CFM output
- ✓ Wheel-mounted for easy manoeuvrability and positioning



Item No:	Input Supply	Motor Power	Receiver Size	Piston Displacement	Max. Air Pressure	EX. VAT	INC. VAT
04387	230v (13A)	2.2kW (3hp)	50ltr	13CFM (368ltr/min)	116psi (8bar)	£249.99	£299.99
04388	230v (13A)	2.2kW (3hp)	100ltr	13CFM (368ltr/min)	116psi (8bar)	£299.99	£359.99

TO PLACE AN ORDER: ☎ 01509 500500

BELT-DRIVE

TIGREN 100ltr (04396) / 150ltr (04391) / 200ltr (04394) 3hp Belt-Drive Compressor

A true workhorse built with a heavy-duty pump and brushless induction motor with 14CFM of powerful piston displacement, and a range of other durable features that make for an extended lifespan.

- ✔ No-nonsense belt-driven compressor
- ✔ Heavy-duty 2-cylinder splash oil-lubricated pump
- ✔ Heavy-duty induction motor for longer life and performance
- ✔ Twin cylinder compression for increased production
- ✔ Wheel-mounted for easy manoeuvrability and positioning



Item No:	Input Supply	Wheel Mounted	Motor Power	Receiver Size	Piston Displacement	Max. Air Pressure	EX. VAT	INC. VAT
04396	230v (13A)	✓	2.2kW (3hp)	100ltr	14CFM (396ltr/min)	150psi (10bar)	£399.99	£479.99
04391	230v (13A)	✓	2.2kW (3hp)	150ltr	14CFM (396ltr/min)	150psi (10bar)	£489.99	£587.99
04394	230v (13A)	✓	2.2kW (3hp)	200ltr	14CFM (396ltr/min)	150psi (10bar)	£569.99	£683.99

BELT-DRIVE TANDEM

ITEM NO: 04386 TIGREN 270LTR TANDEM 2x 3HP BELT-DRIVEN AIR COMPRESSOR

The ultimate no-nonsense workshop compressor, built with robust double pumps and motor units for unrivalled performance. Ideal for workshops where high air demand is required and only a 230v supply is available.

- ✔ No-nonsense workhorse belt-driven compressor
- ✔ 2x heavy-duty 2-cylinder splash oil-lubricated pumps
- ✔ 2 heavy-duty induction motors for long life and performance
- ✔ Twin cylinder compression for increased air production

Don't forget your SIP Anti-Vibration Mounts (see page 102)



MOST AIR POSSIBLE FROM 1 PHASE SUPPLY

Tandem: offering continued operation in the event that a single pump or motor should fail. Perfect for garage or workshop environments where consistent and uninterrupted compressed air production is essential.

Input Supply	Motor Power	Receiver Size	Piston Displacement	Max. Air Pressure	EX. VAT	INC. VAT
230v (32A)	6hp (2x 3hp)	270ltr	HIGH 25CFM (708ltr/min) from 1 Phase	145psi (10bar)	£1,399.99	£1,679.99

ARC WELDERS

TIGREN TGN140MMA (08200) / TGN180MMA (08201) ARC Inverter Welders

- ✔ Digital display for easy power setting
- ✔ 3mtr electrode and Earth leads for flexible welding
- ✔ Lightweight and compact design for simple portability
- ✔ Accessories included



Item No:	Input Supply	Output Current	Duty Cycle	Welding Thickness	EX. VAT	INC. VAT
08200	230v (13A)	20A - 140A	140A @ 20%	1.5mm - 7mm	£89.99	£107.99
08201	230v (16A)	20A - 180A	180A @ 15%	1.5mm - 8mm	£129.99	£155.99

MULTI PROCESS WELDERS

TIGREN TGN120MAT (08202) / TGN150MAT (08203) MIG/ARC/TIG Inverter Welders

- ✔ 4-in-1: Gas/Gasless MIG, ARC/MMA, and TIG processes
- ✔ Infinitely variable output settings for high versatility
- ✔ Lightweight and compact design for simple portability
- ✔ 2-roll wire feed unit with wired-in MIG welding torch
- ✔ Come with accessories, 08203 also includes TIG torch



Item No:	Input Supply	Output Current	Duty Cycle	Wire Spool Size	EX. VAT	INC. VAT
08202	230v (13A)	15A - 120A (MIG) 15A - 70A (MMA/TIG)	120A @ 15% (MIG) 70A @ 15% (MMA/TIG)	Solid & Flux; up to 0.7kg	£179.99	£215.99
08203	230v (13A)	30A - 140A (MIG) 30A - 120A (MMA/TIG)	130A @ 30% (MIG) 120A @ 30% (MMA/TIG)	Solid & Flux; up to 5kg	£289.99	£347.99

TIG WELDER

ITEM NO: 08204 TIGREN TGN200TIG DC TIG Inverter Welder

- ✔ 2-in-1 machine with HF TIG and MMA/ARC processes
- ✔ Integrated IGBT inverter technology platform
- ✔ Lightweight and compact design
- ✔ Comes with torch, welding leads and face shield



Item No:	Input Supply	Output Current	Duty Cycle	EX. VAT	INC. VAT
08204	230v (13A)	10A - 180A (TIG) / 10A - 160A (MMA)	180A @ 15% (TIG) / 160A @ 15% (MMA)	£229.99	£275.99

WELDING HEADSHIELD

ITEM NO: 02801 TIGREN Electronic Welding Headshield

- ✔ 92.5mm x 42.5mm LCD large viewing area
- ✔ High-quality automatic electronic welding headshield
- ✔ Adjustable control: DIN 9 - 13 variable internal control
- ✔ Lightweight and compact design



Viewing Area	Welding Shade	Light-Dark
92.5 x 42.5mm	DIN 9-13 variable internal control	3/10.000sec (0.00003s)
ARC Sensors	EX. VAT	INC. VAT
2 sensors	£29.99	£35.99

OIL DRAINERS

ITEM NO: 08207
TIGREN 50ltr
Gravity Oil Drainer

- ✔ 50ltr reservoir tank
- ✔ Waste oil level indicator
- ✔ Pneumatic waste oil discharge function

ITEM NO: 08208
TIGREN 70ltr
Suction Oil Drainer

- ✔ 70ltr reservoir tank
- ✔ Waste oil level indicator
- ✔ Pneumatic suction function with 5 extraction tubes
- ✔ Pneumatic waste oil discharge



Item No:	Tank Capacity	Discharge Pressure	Extraction Pressure	Min. Adj. Height	Max. Adj. Height	EX. VAT	INC. VAT
08207	50ltr	22psi (1.5bar)	n/a	1030mm	1475mm	£139.99	£167.99
08208	70ltr	22psi (1.5bar)	116psi (8bar) 145psi (10bar)	1040mm	1500mm	£249.99	£299.99

CEMENT MIXERS

TIGREN 63ltr (08212) / 115ltr (08211)
Electric Cement Mixers

Home and DIY building projects are light work for the TIGREN Electric Cement Mixers, thanks to a wide access and user-friendly adjustable angle and tilt settings.

- ✔ Steel drum with a 50ltr (08212) / 85ltr (08211) mixing capacity
- ✔ Large wide drum access with adjustable angle setting and tilt functions for ease-of-operation, emptying and storage
- ✔ Supplied with wheels and handles for easy manoeuvrability



Item No:	Input Supply	Motor Power	Drum	EX. VAT	INC. VAT
08212	230v	220w @ S6 30%	63ltr	£169.99	£203.99
08211	230v	550w @ S6 30%	115ltr	£199.99	£239.99

SAWS

ITEM NO: 08210
TIGREN 12" Contractor Saw

A powerful saw with versatile 0° to 45° tilting and large worktable size to help provide accurate cutting in a range of applications, manufactured from heavy-duty coated steel with tough powder-coated legs, plus wheels for positioning. Perfect for tradespeople, contractors and home enthusiasts.

- ✔ 0°- 45° tilting with cutting up to 83mm @ 0° and 58mm @ 45°
- ✔ Extendable worktable up to 1600mm x 550mm for versatility
- ✔ Heavy-duty coated steel frame with tough powder-coated legs
- ✔ Supplied with rip fence, mitre gauge, push stick, pad, hose
- ✔ **BLADE INCLUDED**



Input Supply	Motor Power	Cutting Capacity	Blade Size
230v (13A)	2200w @ S6 40% 5mins	83mm @ 0° 58mm @ 45°	Ø315 x Ø30mm x 3.6mm 24T

Standard Table Size	Extended Table Size	EX. VAT	INC. VAT
800 x 550mm	1600 x 550mm	£299.99	£359.99

ITEM NO: 08209
TIGREN 16" Log Saw

A powerful saw designed to cut and sever logs quickly and effortlessly via 2-handed cutting with anti-kickback device for the highest operator safety, plus durability through a high-quality powder-coated steel frame. Perfect for the home user and DIY usage.

- ✔ Severs logs up to Ø 140mm and cuts 300mm to 1000mm lengths
- ✔ 2-handed safety cutting with spring-assisted anti-kickback device
- ✔ **TCT BLADE INCLUDED**



Input Supply	Motor Power	Cutting Capacity	Blade Size	EX. VAT	INC. VAT
230v (13A)	2200w @ S2 15mins	Ø 140-300mm 1000mm (L)	Ø405 x Ø30mm 32T	£279.99	£335.99

SIP PILLAR DRILLS

PAGES 30-31



SIP PRESSURE WASHER RANGE



PAGES 10-19
FOR MORE INFO

PRICES FROM
£129.99
EX.VAT

SIP FLOOR & DRUM FAN RANGE

PAGES 8-9
FOR FULL RANGE



PRICES FROM
£49.99
EX.VAT

SIP VALETING MACHINES

PAGES 20-21
FOR MORE INFO



PRICES FROM
£149.99
EX.VAT

SIP
SIP INDUSTRIAL



SIP (INDUSTRIAL PRODUCTS) LIMITED
Gelders Hall Road, Shepshed, Loughborough, Leicestershire LE12 9NH. UK



SIP 4 YEAR WARRANTY
SIP INDUSTRIAL



VISIT: WWW.SIP-GROUP.COM FOR FULL DETAILS

Item No: 00776 UK (£) Edition
VAT Address @ 20%

Every reasonable effort has been made to present current and accurate information at time of print. However, SIP reserve the right to change promotion details or product specifications without notice. Photographs are for illustration purposes only. E&OE. Contents & images are copyright © SIP Ltd. & cannot be reproduced without express written permission. Prices exclude VAT unless otherwise stated.

100% UK MADE