

THE 2024 TOOL



THE TOOL COMPANY

PROMOTION

Rated 'Excellent' on
Trustpilot

@sealeytools

APRIL-JUNE

OVER 80 NEW LINES INSIDE



INTRODUCING THE **NEW APMS120P**

WITH HARDWOOD WORKBENCH,
PEGBOARD PANELS AND MOBILE BASE UNITS.
SEE PAGE 111 FOR DETAILS.

In this edition:
STORAGE SOLUTIONS // VEHICLE MAINTENANCE // HAND TOOLS // CAR CLEANING

**COMPETITION
WIN THIS POWER
TOOL BUNDLE**

WORTH
OVER £670



**SEE
PAGE 3**

Why Choose **SEALEY**?

- A comprehensive and expanding product range.
- Huge stock levels and fast despatch.
- Uncompromising quality, unbeatable value.
- No-quibble long-term and lifetime guarantees*.
- Unrivalled aftersales service.
- Innovation and continuous product development.
- Meticulous quality control.
- Full spare parts back-up service.

*Please refer to www.sealey.co.uk/guarantee for more information on guarantees.



Huge Stocks & Fast Dispatch

We hold over £50million worth of stock at our modern, computer-controlled warehousing and advanced stock forecasting enables, on average, 99.6% of our entire product range to be despatched within 24hrs.

Spare Parts

We have an extensive inventory of over 120,000 spare parts, ensuring quick turnaround for repairs. Orders received before 5pm are dispatched the same day, with next-day delivery available to Mainland UK for orders placed before 5.15pm Monday to Friday.

Long-Term Aftersales Support

We are committed to long-term aftersales support through our team of experienced technical advisors, an in-house workshop with 20 service engineers, and full spare parts service. Count on us for ongoing product support, ensuring many years of use from your Sealey products, even if a model is discontinued.

Find Your Local Stockist

www.sealey.co.uk/stockist-locator



+44 (0)1284 757500



sales@sealey.co.uk



www.sealey.co.uk

SEALEY Group Brands



Made for the trade, the SEALEY brand is defined by traditional designs and proven reliability. Our core range, trusted for 45 years, is one of the UK's market leaders in tools and equipment.



Manufactured from high quality materials to exacting standards for a long and durable life, our Premier range delivers exceptional performance at a competitive price.



Offering impressive reliability with exceptional value for money. Our Siegen range is backed up with the same professional aftersales service as the SEALEY and Premier ranges.



A trusted brand in the construction sector, and as members of the BSIF, we are dedicated to delivering high-quality safety products and equipment that enhance performance and are specifically designed to keep you safe in the workplace.

 **Trustpilot**
Rated **'Excellent'**

What did you think of your recent purchase?

To help other customers feel confident about choosing SEALEY, we'd love for you to share your experience. Scan the code to leave a review.



SEALEY.CO.UK/LATEST-COMPETITIONS



ENTER NOW



Worth over
£670

COMPETITION CLOSING 30TH JUNE 2024
TERMS AND CONDITIONS APPLY

Win this
**Amazing
Power Tool
BUNDLE** with
Storage rack

Long-Term Guarantees

At SEALEY, we take pride in offering the best guarantees. All Premier and Siegen Hand Tools are covered by our no-quibble lifetime guarantee* against manufacturing defects, with many other products benefiting from our 2, 3, 5 or 10 year guarantees where indicated.

Social Media

We are constantly posting new videos, workshop stories, reels and engaging tool-related content - as well as our popular 'How To' series on YouTube - providing tool users like you with lots of handy tips and tricks. Tap follow and drop a comment to say hello.

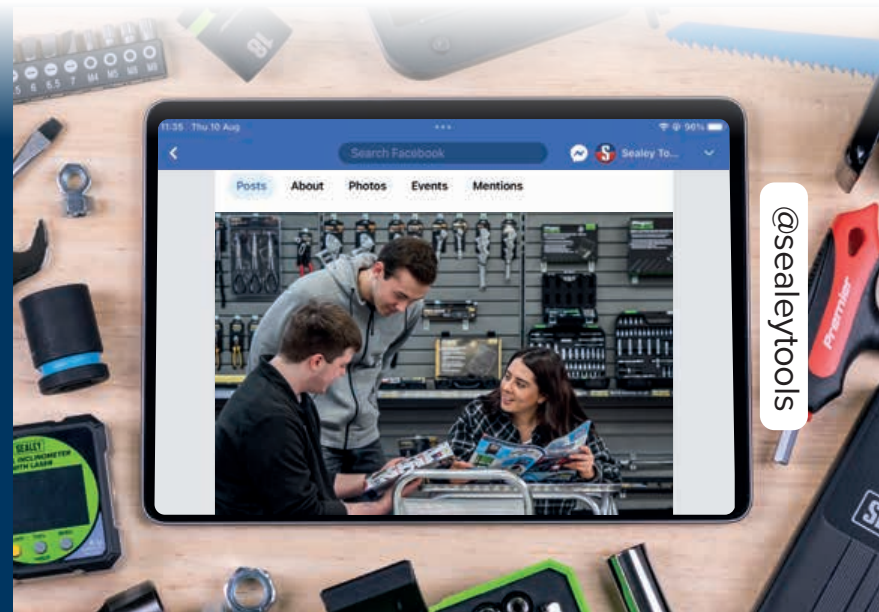

Contents

Explore fantastic seasonal offers inside our latest edition of the Tool Promotion, showcasing over 1500 products with more than 80 new lines. This edition highlights categories such as Storage, Vehicle Maintenance, Hand Tools, and Car Cleaning. Exclusive discounts are also available on selected items throughout our entire product range, ensuring that you find the perfect deal inside!

1	Hand Tools	4-21
2	Jacking & Lifting	22-27
3	Motorcycle Tools	28-31
4	Vehicle Service Tools	32-55
5	Battery Chargers & Starters	56-57
6	Lubrication	58-61
7	Bodyshop	62-67
8	Welding & Cutting	68-71
9	Compressors	72-75
10	Air Power Tools	76-77
11	Electric Power Tools	78-89
12	Power Tool Accessories	90-93
13	Storage & Workstations	94-117
14	Consumables	118-119
15	Lighting & Power	120-123
16	Machine Shop	124-131
17	Cooling & Air Treatment	132-139
18	Safety Products	140-141
19	Janitorial, Material Handling & Leisure	142-159
Clearance		160-163

For direct access to all our social media channels, scan the QR code.





Wheel Fitting & Alignment Tool

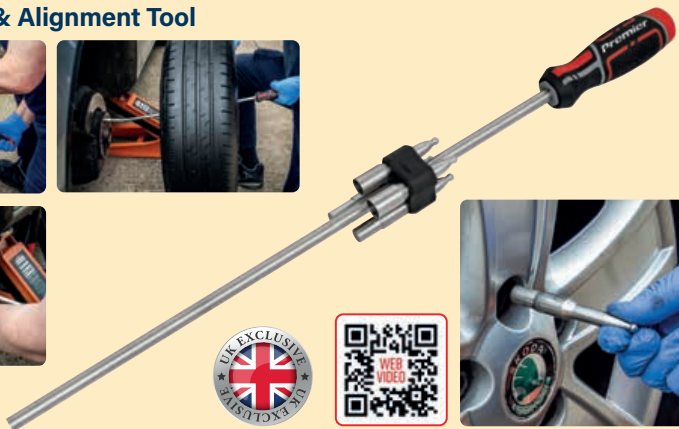

- Designed to assist with the lifting and locating of road wheels on to vehicle hubs and intended to be used where there is no access to a vehicle lift such as by the roadside.
- Significantly reduces lifting effort whilst notably improving body posture.
- Supplied with four CNC machined stainless steel adaptor pegs complete with storage holder.
- Suitable for most cars, light goods vehicles, motor homes and caravans.
- Manufactured from high quality stainless steel.
- Polypropylene and TPV rubber soft grip handle for comfort and control.
- For use on alloy or steel wheels up to 35kg.
- Exclusive patented design.
- **Model No. AK7500**
- List Price £41.95

£32.95 Exc. VAT
£39.54 Inc. VAT

Breaker Bars

3/8" Sq Drive OR 1/2" Sq Drive
450mm Length
600mm Length
OR
750mm Length



*Note: Knuckle joints are not covered by the lifetime guarantee and are treated as consumable items.

- Hardened and tempered Chrome Vanadium steel bars with high chrome finish.
- Long, slim style handles and spring loaded socket retention.
- Fully replaceable knuckle joint*.

Model No.	Drive	Length	List Price	Exc. VAT	Inc. VAT
AK729	3/8" Sq	450mm	£23.45	£15.95	£19.14
AK730	1/2" Sq	600mm	£30.45	£17.95	£21.54
AK7302	1/2" Sq	750mm	£34.95	£20.95	£25.14

1000mm Breaker Bars

- Hardened and tempered Chrome Vanadium steel bars with high chrome finish.
- Long, slim style handles and spring loaded socket retention.
- Fully replaceable knuckle joint*.

3/4" Sq Drive OR 1" Sq Drive

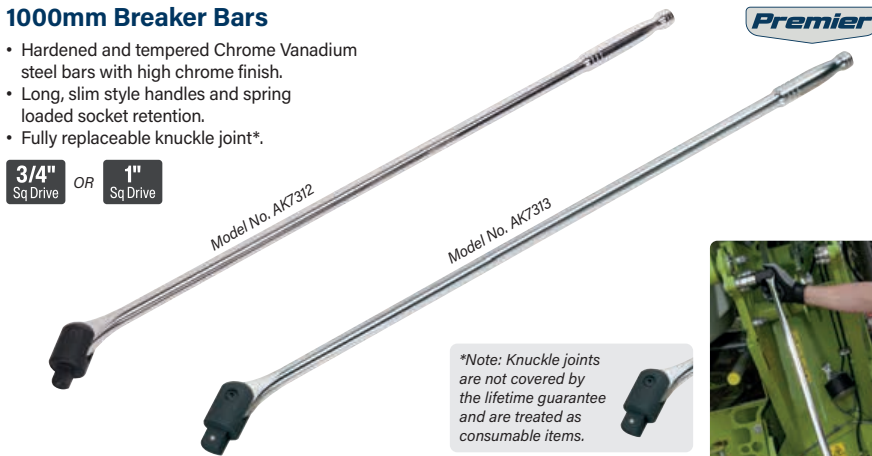

*Note: Knuckle joints are not covered by the lifetime guarantee and are treated as consumable items.

Model No.	Drive	Length	List Price	Exc. VAT	Inc. VAT
AK7312	3/4" Sq	1000mm	£117.95	£74.95	£89.94
AK7313	1" Sq	1000mm	£132.95	£89.95	£107.94

1/2" Sq Drive Extendable Breaker Bar

NEW Product

1/2" Sq Drive



*Note: Knuckle joints are not covered by the lifetime guarantee and are treated as consumable items.

- Hardened and tempered Chrome Vanadium steel with a fully polished mirror finish.
- Handle extension retained at set increments with a quick release locking ring giving five different shaft lengths from 480-630mm.
- Spring loaded socket retention.
- Fully replaceable knuckle joint*.
- **Model No. AK7308**
- List Price £34.95

£24.95 Exc. VAT
£29.94 Inc. VAT

1/2"-3/4" Sq Drive Torque Multiplier

1/2" Sq Drive Input OR 3/4" Sq Drive Output
300-1000Nm



- Robust construction with 1/2" Sq Female input and 3/4" Sq Male output drives.
- Multiplication achieved by planetary gear train at a gear ratio of 1:3.3.
- Compatible with a wide range of drive tools including torque and ratchet wrenches.
- Adjustable length reaction arm makes it ideal for limited access use.
- Max. Rated Input: 300Nm (225lb.ft).
- Max. Rated Output: 1000Nm (750lb.ft).
- **Model No. AK629**
- List Price £319.95

£239.95 Exc. VAT
£287.94 Inc. VAT

7pc 1/2"-3/4" Sq Drive Torque Multiplier Set

231-1500Nm

1/2" Sq Drive Input OR 3/4" Sq Drive Output



- Robust construction with 1/2" Sq drive female input and 3/4" Sq drive male output.
- Accurately delivered torque multiplication factor of 1:6.5.
- Compatible with a wide range of drive tools including torque and ratchet wrenches.
- Includes straight and 90° reaction bars, reaction base, two breakaway adaptors* and L-type hex key.
- Max. Rated Input/Output: 231Nm (170lb.ft)/1500Nm (1100lb.ft).
- **Model No. AK6290**
- List Price £579.95

£399.95 Exc. VAT
£479.94 Inc. VAT

*Note: Breakaway adaptors are not covered by the lifetime guarantee and are treated as consumable items.

94pc 1/4" & 1/2" Sq Drive Socket Set

Siegen

1/4" & 1/2" Sq Drive 72-Tooth

MIRROR FINISH

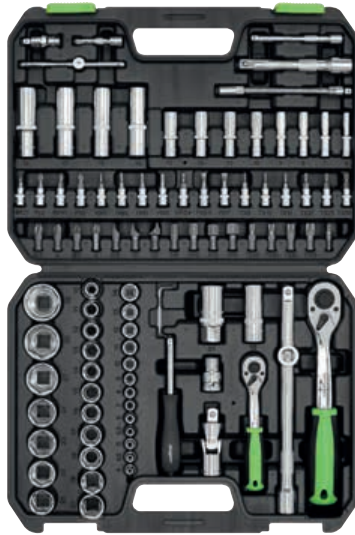

- Covers sizes from 4 to 32mm.
- Includes 72-tooth comfort grip ratchet wrenches, spark plug sockets, extension bars, socket bits, spinner handle and accessories.
- See www.sealey.co.uk for full contents and details.
- **Model No. S01210**
- List Price £136.95

£84.95 Exc. VAT
£101.94 Inc. VAT



171pc 1/4", 3/8" & 1/2" Sq Drive Socket Set

Siegen

1/4", 3/8" & 1/2" Sq Drive 72-Tooth

MIRROR FINISH



- Covers sizes from 4 to 32mm.
- Includes 72-tooth comfort grip ratchet wrenches, spark plug sockets, extension bars, socket bits, spinner handle and accessories.
- See www.sealey.co.uk for full contents and details.
- **Model No. S01211**
- List Price £218.95

£139.95 Exc. VAT
£167.94 Inc. VAT



219pc 1/4", 3/8" & 1/2" Sq Drive Socket Set

Siegen

1/4", 3/8" & 1/2" Sq Drive

72-Tooth

MIRROR FINISH



- Covers sizes from 4 to 32mm.
- Includes 72-tooth ratchet wrenches, spark plug sockets, extension bars, female TRX-Star* sockets, socket bits, combination spanners, bits, hex keys and accessories.
- See www.sealey.co.uk for full contents and details.
- **Model No. S01212**
- List Price £279.95

£169.95 Exc. VAT
£203.94 Inc. VAT



135pc Mechanic's Tool Kit

Siegen

1/4" & 1/2" Sq Drive

- Comprehensive range of frequently used hand tools.
- 1/4" and 1/2" Sq drive reversible ratchet wrenches.
- Includes 1/4", 3/8" and 1/2" Sq drive sockets, hex keys, combination spanners, screwdrivers, pliers, utility knife, bit set and accessories.
- Tools feature soft grip handles for comfort and control.
- See www.sealey.co.uk for full contents and details.
- **Model No. S01214**
- List Price £239.95

£149.95 Exc. VAT
£179.94 Inc. VAT



3 Drawer Portable Tool Chest with 98pc Tool Kit

Siegen

NEW Product

1/4" & 1/2" Sq Drive



- Comprehensive range of frequently used hand tools.
- 1/4" and 1/2" Sq drive reversible ratchet wrenches.
- Includes 1/4" and 1/2" Sq drive sockets, hex keys, combination spanners, screwdrivers, bit set, inspection mirror, magnetic pick up tool, ball-pein hammer, pliers and accessories.
- Tools feature soft grip handles for comfort and control.
- Supplied in a sturdy, fully portable metal tool chest with EVA foam trays.
- **Model No. S01266**
- List Price £349.95

£259.95 Exc. VAT
£311.94 Inc. VAT



73pc Tool Kit

Siegen

- Includes a selection of screwdrivers with satin finish Chrome Vanadium steel shafts and soft grip handles for comfort and control.
- Tape measure, insulating tape and mains tester also included.
- Electrical screwdrivers insulated for use up to 1000V.
- See www.sealey.co.uk for full contents and details.
- **Model No. S01220**
- List Price £86.95

£59.95 Exc. VAT
£71.94 Inc. VAT



24pc Tool Kit

Siegen

- Comprehensive tool kit includes screwdrivers, pliers, hammer, junior hacksaw, shears, knife, hex keys, adjustable wrench, mains tester, tape measure and insulating tape.
- Tools feature soft grip handles for comfort and control.
- See www.sealey.co.uk for full contents and details.
- **Model No. S01222**
- List Price £89.95

£59.95 Exc. VAT
£71.94 Inc. VAT



84pc Tool Kit

Siegen

- Comprehensive range of frequently used hand tools.
- 3/8" Sq Drive reversible ratchet wrench.
- Includes 3/8" Sq drive sockets, hex keys, combination spanners, screwdrivers, pliers, hammer, mini hacksaw, bit driver, bits and accessories.
- Tools feature soft grip handles for comfort and control.
- See www.sealey.co.uk for full contents and details.
- **Model No. S01213**
- List Price £164.95

£112.95 Exc. VAT
£135.54 Inc. VAT



90pc Electrician's Tool Kit

Siegen

- Comprehensive range of frequently used hand tools.
- Manufactured from hardened and tempered Chrome Vanadium steel.
- All screwdrivers and pliers are VDE approved.
- Includes 1/4" and 1/2" Sq drive sockets, hex keys, spanners, screwdrivers, mains tester, pliers, tape measure, ball peen hammer, scissors, bits and accessories.
- See www.sealey.co.uk for full contents and details.
- **Model No. S01217**
- List Price £289.95

£179.95 Exc. VAT
£215.94 Inc. VAT

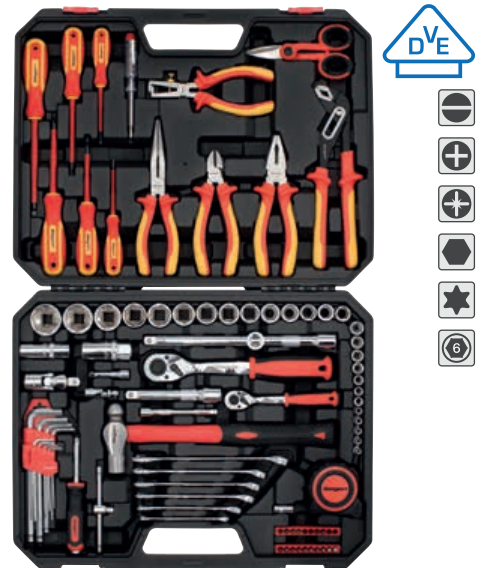

Tool Kits with Cantilever Toolbox

Siegen

1/4" & 3/8" Sq Drive

1/4" & 1/2" Sq Drive



Model No. S01215

Model No. S01216

- Comprehensive range of frequently used hand tools.
- Tools feature soft grip handles for comfort and control.
- Housed in a metal, cantilever toolbox.
- See www.sealey.co.uk for full contents and details.

Model No.	Qty	Drive	List Price	Exc. VAT	Inc. VAT
S01215	70pc	1/4" & 3/8" Sq	£179.95	£99.95	£119.94
S01216	86pc	1/4" & 1/2" Sq	£269.95	£149.95	£179.94

144pc Mechanic's Tool Kits

Premier

1/4", 3/8" & 1/2" Sq Drive



Model No. AK7980HV



Model No. AK7980

- 1/4" and 1/2" Sq drive 72-Tooth offset comfort grip ratchet wrenches.
- Includes 1/4", 3/8" and 1/2" Sq drive sockets, hex keys, spanners, screwdrivers, pliers, bits and accessories.
- Housed in a sturdy storage case with reinforced corners, aluminium trim and lockable metal catches.
- Case Size (W x D x H): 465 x 395 x 105mm.

Model No.	Colour	List Price	Exc. VAT	Inc. VAT
AK7980	Red	£279.95	£199.95	£239.94
AK7980HV	Green	£279.95	£199.95	£239.94



Socket Sets

1/4" Sq Drive 3/8" Sq Drive OR 1/2" Sq Drive
 48-Tooth Gear **2** Gear MM

Premier



Model No. AK8990

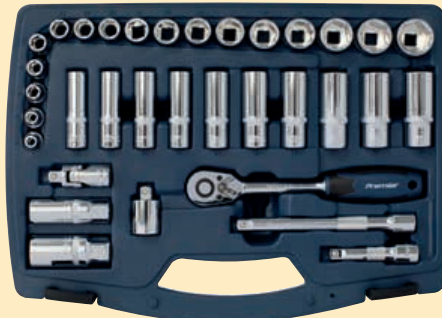

Model No. AK8991



Model No. AK8992



Model No. AK8993

- Deluxe professional socket sets with heat treated Chrome Vanadium steel WallDrive® sockets.
- Flip reverse ratchet with quick socket release.
- Gear-to-Gear ratchet head design is much stronger than traditional styles and offers up to 30% more torque.

Model No.	Qty	Drive	Contents	List Price	Exc. VAT	Inc. VAT
AK8990	33pc	1/4" Sq	Standard Sockets; 4-14mm, Deep Sockets; 4-14mm, Extension Bars; 50, 100, 150mm, Sliding T-Bar, 1/4" Sq Drive 48-Tooth Gear-to-Gear Ratchet Wrench with Quick Release, Spinner Handle, Universal Joint	£71.95	£49.95	£59.94
AK8991	34pc	3/8" Sq	Standard Sockets; 6-24mm, Deep Sockets; 10-19mm, Spark Plug Sockets; 16, 21mm, Extension Bars; 75, 150mm, 3/8" Sq Drive 48-Tooth Gear-to-Gear Ratchet Wrench, Universal Joint, 1/2" Sq Drive - 3/8" Sq Drive Male Adaptor	£89.95	£59.95	£71.94
AK8992	26pc	1/2" Sq	Standard Sockets; 8-32mm, Spark Plug Sockets; 16, 21mm, Extension Bars; 75, 125, 250mm, 1/2" Sq Drive 48-Tooth Gear-to-Gear Ratchet Wrench, Universal Joint, 3/8" Sq Drive - 1/2" Sq Drive Male Adaptor	£103.95	£79.95	£95.94
AK8993	41pc	1/2" Sq	Standard Sockets; 8-32mm, Deep Sockets; 8-24mm, Spark Plug Sockets; 16, 21mm, Extension Bars; 75, 125, 250mm, 1/2" Sq Drive 48-Tooth Gear-To-Gear Ratchet Wrench, Universal Joint, 3/8" Sq Drive - 1/2" Sq Drive Male Adaptor	£126.95	£89.95	£107.94

21pc 1" Sq Drive Socket Set

1" Sq Drive 6 MM

Siegen

- Heat treated, drop-forged, Chrome Vanadium steel with fully polished chrome plating for corrosion resistance.
- Contents: 6-Point Standard Sockets; 36-80mm, Extension Bars; 200, 400mm, Sliding T-Bar, 1" Sq Drive Ratchet Wrench.
- **Model No. S0768**
- List Price £549.95

£399.95 Exc. VAT
£479.94 Inc. VAT



3/4" Sq Drive 12-point WallDrive® Socket Sets

3/4" Sq Drive 12

Premier

NEW Product Available Early April

MM Model No. AK2585

MM Model No. AK2583

MM & IMP Model No. AK2584

DUAL FINISH



- Manufactured from heat treated drop-forged Chrome Vanadium steel.
- Hardened and tempered with dual satin chrome finish.
- WallDrive® sockets grip the flats of the fixing giving maximum torque transfer.

Model No.	Qty	Contents	List Price	Exc. VAT	Inc. VAT
AK2585	15pc	Standard Sockets; 19-50mm, 3/4" Sq Drive Reversible Ratchet Wrench, Extension Bars; 100mm, 200mm, 450mm Sliding T-Bar	£159.95	£119.95	£143.94
AK2583	15pc	Standard Sockets; 19-50mm, 500mm 3/4" Sq Drive Quick Release Ratchet Wrench, Extension Bars; 100, 200mm, 450mm Sliding T-Bar	£259.95	£149.95	£179.94
AK2584	26pc	Standard Metric Sockets; 22-50mm; Standard Imperial Sockets; 7/8"-2", 500mm 3/4" Sq Drive Quick Release Ratchet Wrench, Extension Bars; 100, 200mm, 450mm Sliding T-Bar	£319.95	£169.95	£203.94

3/4" Sq Drive Impact Extension Bars

3/4" Sq Drive

- Drop-forged steel extension bars.
- Suitable for use on all types of air impact tool.
- Chrome Molybdenum steel with phosphate finish for added corrosion resistance.
- Spring-ball socket retainer and drilled head to accept retaining pin.

Model No.	Size	List Price	Exc. VAT	Inc. VAT
AK5505	100mm	£27.95	£17.95	£21.54
AK5506	150mm	£30.95	£19.95	£23.94
AK5507	200mm	£38.95	£24.95	£29.94
AK5508	250mm	£47.95	£29.95	£35.94



8pc 1/2" Sq Drive Hex Impact Socket Bit Set

Premier

1/2" Sq Drive



MM



- Chrome Molybdenum steel impact sockets with 1/2" Sq drive.
- Phosphate finish for added corrosion resistance.
- Suitable for use with any impact tool.
- Contents: 5, 6, 8, 10, 12, 14, 17, 19mm.
- Length: 78mm.
- **Model No. AK5601**
- List Price £83.95

£51.95 Exc. VAT
£62.34 Inc. VAT

8pc 1/2" Sq Drive TRX-Star* Impact Socket Bit Set

Premier

1/2" Sq Drive



- Chrome Molybdenum steel impact sockets with 1/2" Sq drive.
- Phosphate finish for added corrosion resistance.
- Suitable for use with any impact tool.
- Contents: T30, T40, T45, T50, T55, T60, T70, T80.
- Length: 78mm.
- **Model No. AK5602**
- List Price £82.95

£51.95 Exc. VAT
£62.34 Inc. VAT

8pc 1/2" Sq Drive Spline Impact Socket Bit Set

Premier

1/2" Sq Drive



- Chrome Molybdenum steel impact sockets with 1/2" Sq drive.
- Phosphate finish for added corrosion resistance.
- Suitable for use with any impact tool.
- Contents: M5, M6, M8, M10, M12, M14, M16, M18.
- Length: 78mm.
- **Model No. AK5604**
- List Price £87.45

£51.95 Exc. VAT
£62.34 Inc. VAT

6pc 1/2" Sq Drive Impact Adaptor & Extension Bar Set

Premier

1/2" Sq Drive



- Chrome Vanadium steel extension bars and adaptors.
- Chrome Molybdenum steel universal joint.
- Phosphate finish for added corrosion resistance.
- Suitable for use with any impact tool.
- Spring-ball socket retainer.
- Contents: Extension Bars; 75, 150, 250mm, Adaptors; 1/2"(F) x 3/8"(M), 1/2"(F) x 3/4"(M), Universal Joint.
- **Model No. AK5603**
- List Price £59.95

£34.95 Exc. VAT
£41.94 Inc. VAT

8pc 3/4" Sq Drive Deep Impact Socket Set

Premier

3/4" Sq Drive 24-38mm Deep 6 MM



- Manufactured from Chrome Molybdenum steel with manganese phosphate finish for added corrosion resistance.
- Deep WallDrive® sockets.
- Suitable for use with impact type air wrenches.
- Sizes: 24, 27, 29, 30, 32, 35, 36, 38mm.
- **Model No. AK885**
- List Price £132.95

£84.95 Exc. VAT
£101.94 Inc. VAT

8pc 1" Sq Drive Deep Impact Socket Set

Premier

1" Sq Drive 24-41mm Deep 6 MM



- Manufactured from Chrome Molybdenum steel with manganese phosphate finish for added corrosion resistance.
- Deep WallDrive® sockets.
- Suitable for use with impact type air wrenches.
- Sizes: 24, 27, 30, 32, 33, 34, 36, 41mm.
- **Model No. AK888M**
- List Price £139.95

£89.95 Exc. VAT
£107.94 Inc. VAT

3/8" & 1/2" Sq Drive Impact TRX-Star*/Hex/Spline Bit Sets

Model No. AK21901

Model No. AK21902



- High quality impact grade S2 steel satin finish.
- Specially heat treated CNC machined tips reduce stress and prevent cam-out under load.
- Torsion bits absorb impact and transfer maximum torque to the fixing.
- Hardened (58-62 HRC) and tempered for added strength.
- Colour-coded for fast identification.
- Model No. AK21901 - each size in 36 and 75mm length bits, Model No. AK21902 - 36mm length bits.



Model No.	Qty	Contents	List Price	Exc. VAT	Inc. VAT
AK21901	42pc	TRX-Star* Bits; T20-T60 (1 each 36 and 75mm), Hex Bits; 4-12mm (1 each 36 and 75mm), Spline Bits; M5-M12 (1 each 36 and 75mm), Drive Adaptors; 3/8" Sq x 10mm Hex, 1/2" Sq x 10mm Hex	£86.95	£59.95	£71.94
AK21902	28pc	TRX-Star* Bits; T10-T60, Hex Bits; 4-12mm, Spline Bits; M5-M18, Drive Adaptors; 3/8" Sq x 10mm Hex, 1/2" Sq x 10mm Hex	£51.95	£34.95	£41.94

13pc 1/2" Sq Drive Total Drive® Impact Socket Set



- Hardened and heat treated Chrome Molybdenum steel Total Drive® impact sockets with a phosphate finish for corrosion resistance.
- All are suitable for Spline, Metric Hex and Metric Bi-Hex and many are equivalent to TRX-Star*, Whitworth, Imperial Hex and Imperial Bi-Hex.
- Sizes: 10-24mm.
- **Model No. AK5613TD**
- List Price £66.95

£42.95 Exc. VAT
£51.54 Inc. VAT

13pc 1/2" Sq Drive Impact Socket Set



- Manufactured from Chrome Vanadium steel, hardened, tempered and with a phosphate finish for added corrosion resistance.
- Standard depth 6-point WallDrive® sockets allow a transfer of up to 30% more torque to the fixing.
- Sizes: 10-24mm.
- **Model No. AK5613M**
- List Price £38.95

£22.95 Exc. VAT
£27.54 Inc. VAT

16pc 1/2" Sq Drive Impact Socket Set



- Manufactured from Chrome Vanadium steel, hardened, tempered and with a phosphate finish for added corrosion resistance.
- Standard depth 6-point WallDrive® sockets allow a transfer of up to 30% more torque to the fixing.
- Sizes: 10-32mm.
- **Model No. AK5624M**
- List Price £64.95

£39.95 Exc. VAT
£47.94 Inc. VAT

16pc 1/2" Sq Drive Deep Impact Socket Set



- Manufactured from Chrome Vanadium steel, hardened, tempered and with a phosphate finish for added corrosion resistance.
- Deep WallDrive® sockets allow a transfer of up to 30% more torque to the fixing.
- Sizes: 10-32mm.
- **Model No. AK5816M**
- List Price £99.95

£57.95 Exc. VAT
£69.54 Inc. VAT

34pc 1/2" Sq Drive Impact Socket Set

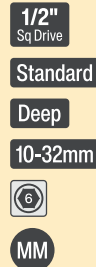

- Master set of impact sockets manufactured from Chrome Vanadium steel.
- Hardened and tempered with a phosphate finish for added corrosion resistance.
- Standard and deep WallDrive® sockets allow a transfer of up to 30% more torque to the fixing.
- Contents: 10-32mm (1 of each Standard and Deep), 125mm Extension Bar, Universal Joint.
- **Model No. AK5634M**
- List Price £152.95

£92.95 Exc. VAT
£111.54 Inc. VAT

Dust-Free Ratchet Wrenches - Flip Reverse

Premier

1/4" Sq Drive OR 3/8" Sq Drive OR 1/2" Sq Drive
72-Tooth
Gear 2 Gear



- Chrome Vanadium steel ratchet wrenches.
- Hardened, tempered and finished in deep polished high chrome.
- Slim style contoured handles.
- 72-tooth gear-to-gear ratchet with flip reverse.
- Sealed heads keeps dirt and other contaminants out of the ratchet mechanism.

Model No.	Drive	Length	List Price	Exc. VAT	Inc. VAT
AK660DF	1/4" Sq	125mm	£22.95	£16.95	£20.34
AK661DF	3/8" Sq	195mm	£27.95	£21.95	£26.34
AK662DF	1/2" Sq	250mm	£33.95	£24.95	£29.94

Ratchet Wrenches - Premier Black

Premier
Black

1/4" Sq Drive
3/8" Sq Drive
OR
1/2" Sq Drive



72-Tooth

- Heat treated and hardened Chrome Vanadium steel.
- Fully polished black chrome finish with machined and lacquered heads.
- 72-tooth flip reverse ratchet with push-button quick release.

Model No.	Drive	Length	List Price	Exc. VAT	Inc. VAT
AK7997	1/4" Sq	140mm	£22.95	£14.95	£17.94
AK7998	3/8" Sq	200mm	£29.95	£19.95	£23.94
AK7999	1/2" Sq	265mm	£37.95	£24.95	£29.94

Locking Flexi-Head Extendable Ratchet Wrenches - Premier Platinum

Premier
Platinum series

3/8" Sq Drive OR 1/2" Sq Drive
72-Tooth Extendable



- Hardened and tempered Chrome Vanadium steel with a fully polished micro satin finish.
- Extension retained at set increments with a quick release locking ring giving different shaft lengths.
- Features 180° locking flexi-head.
- Compact head design and ultra-smooth 72-tooth ratchet action allowing ratcheting in increments of 5° for ease of use in restricted areas.
- Textured soft grip handle for comfort and control.
- Features flip reverse and quick release mechanism.

Model No.	Drive	Length	Increments	List Price	Exc. VAT	Inc. VAT
AK8983	3/8" Sq	260-375mm	23mm	£64.95	£37.95	£45.54
AK8984	1/2" Sq	295-435mm	23mm	£75.95	£41.95	£50.34

1/2" Sq Drive Digital Torque Adaptor with Angle Function 20-200Nm

Premier

1/2" Sq Drive 20-200Nm

TORQUES IN BOTH DIRECTIONS



- Designed for use with a standard ratchet or breaker bar.
- Large LCD display with LED/audible alarm indicating achieved and target torque levels.
- Selectable readings in Nm, lb.ft, lb.in or kgf.m.
- Accurate to ±2% of stated capacity and operates in either direction.
- Features angle mode, eliminating the need for angle gauges and protractors providing an accurate and fast way to measure torque plus angle tightening sequences.
- Includes auto-shut-off.
- Supplied with test certificate and storage case.
- Model No. STW291
- List Price £139.95



£81.95 Exc. VAT
£98.34 Inc. VAT

1/4" Sq Drive Micrometer Style Torque Wrench 5-25Nm

Premier

1/4" Sq Drive 5-25Nm

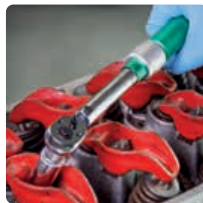

- Range: 5-25Nm(3.7-18.5lb.ft).
- Flip reverse Chrome Vanadium steel ratchet head with smooth action mechanism.
- Scale graduated in Nm and lb.ft.
- Calibration tolerance in accordance with BS EN ISO 6789-1:2017.
- Wrenches are individually tested to standards with ±4% accuracy and each wrench is issued with an individually numbered test certificate.
- Aluminium knurled handle for comfort and control.
- Supplied in an EVA tray.
- Model No. STW901
- List Price £59.95

£39.95 Exc. VAT
£47.94 Inc. VAT

3/8" Sq Drive Micrometer Style Torque Wrenches

Premier

3/8" Sq Drive
5-25Nm OR 20-120Nm



- Flip reverse Chrome Vanadium steel ratchet heads with smooth action mechanism.
- Scale graduated in Nm and lb.ft.
- Calibration tolerance in accordance with BS EN ISO 6789-1:2017.
- Wrenches are individually tested to standards with ±4% accuracy and each wrench is issued with an individually numbered test certificate.
- Aluminium knurled handle for comfort and control.
- Supplied in an EVA tray.

Model No.	Range	List Price	Exc. VAT	Inc. VAT
STW902	5-25Nm(3.7-18.5lb.ft)	£67.95	£44.95	£53.94
STW903	20-120Nm(14.8-88.6lb.ft)	£94.95	£64.95	£77.94

1/2" Sq Drive Micrometer Style Torque Wrenches

Premier

1/2" Sq Drive
40-220Nm
OR
60-330Nm



- Flip reverse Chrome Vanadium steel ratchet heads with smooth action mechanism.
- Scale graduated in Nm and lb.ft.
- Calibration tolerance in accordance with BS EN ISO 6789-1:2017.
- Wrenches are individually tested to standards with ±4% accuracy and each wrench is issued with an individually numbered test certificate.
- Aluminium knurled handle for comfort and control.
- Supplied in an EVA tray.

Model No.	Range	List Price	Exc. VAT	Inc. VAT
STW904	40-220Nm(29.5-162.4lb.ft)	£99.95	£66.95	£80.34
STW905	60-330Nm(44.3-243.5lb.ft)	£109.95	£69.95	£83.94

3/4" Sq Drive Micrometer Style Torque Wrenches

Premier

3/4" Sq Drive
100-600Nm
OR
160-800Nm



- Flip reverse Chrome Vanadium steel ratchet heads with smooth action mechanism.
- Scale graduated in Nm and lb.ft.
- Calibration tolerance in accordance with BS EN ISO 6789-1:2017.
- Wrenches are individually tested to standards with ±4% accuracy and each wrench is issued with an individually numbered test certificate.
- Aluminium knurled handles for comfort and control.
- Supplied in storage case.

Model No.	Range	List Price	Exc. VAT	Inc. VAT
STW906	100-600Nm(73.8-442.8lb.ft)	£449.95	£299.95	£359.94
STW907	160-800Nm(118.1-590.4lb.ft)	£499.95	£319.95	£383.94

12pc Combination Spanner Set

Siegen

8-19mm



MM



- Drop-forged Chrome Vanadium steel combination spanners.
- Hardened, tempered and nickel chrome plated for corrosion resistance.
- Open-end and 12-point WallDrive® ring combination.
- Sizes: 8, 9, 10, 11, 12, 13, 14, 15, 16, 17, 18, 19mm.
- Supplied in storage/carry rack.
- **Model No. S0563**
- List Price £34.45

MIRROR FINISH

£21.95 Exc. VAT

£26.34 Inc. VAT

11pc Combination Spanner Set - Imperial

Siegen

1/4"-7/8"



IMP



- Drop-forged Chrome Vanadium steel combination spanners.
- Hardened, tempered and nickel chrome plated for corrosion resistance.
- Open-end and 12-point WallDrive® ring combination.
- Sizes: 1/4", 5/16", 3/8", 7/16", 1/2", 9/16", 5/8", 11/16", 3/4", 13/16", 7/8".
- Supplied in storage/carry rack.
- **Model No. S0857**
- List Price £34.45

MIRROR FINISH

£21.95 Exc. VAT

£26.34 Inc. VAT

8pc Combination Spanner Set - Whitworth

Siegen

1/8"-9/16"



WW

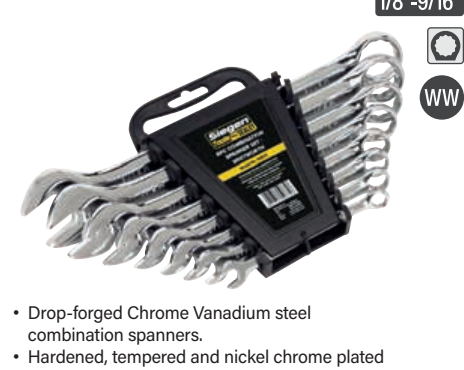

- Drop-forged Chrome Vanadium steel combination spanners.
- Hardened, tempered and nickel chrome plated for corrosion resistance.
- Open-end and 12-point WallDrive® ring combination.
- Popular sizes for the classic car enthusiast.
- Sizes - Whitworth: 1/8", 3/16", 1/4", 5/16", 3/8", 7/16", 1/2", 9/16".
- Supplied in storage/carry rack.
- **Model No. S0870**
- List Price £46.95

MIRROR FINISH

£27.95 Exc. VAT

£33.54 Inc. VAT

Combination Spanner Sets



Model No. AK63265

MM

MIRROR FINISH



- Chrome Vanadium steel combination spanners.
- Hardened, tempered and nickel chrome plated for corrosion resistance.
- Fully polished mirror finish.
- Open-end and 12-point WallDrive® ring combination.
- Supplied in an EVA foam storage tray.

Premier

Model No. AK63266

IMP



Model No.	Qty	Contents	List Price	Exc. VAT	Inc. VAT
AK63265	12pc	8, 9, 10, 11, 12, 13, 14, 15, 16, 17, 18, 19mm	£44.95	£29.95	£35.94
AK63266	11pc	1/4", 5/16", 3/8", 7/16", 1/2", 9/16", 5/8", 11/16", 3/4", 13/16", 7/8"	£44.95	£29.95	£35.94

50pc Multipurpose Spanner Set

Siegen

6-32mm



MM

MIRROR FINISH

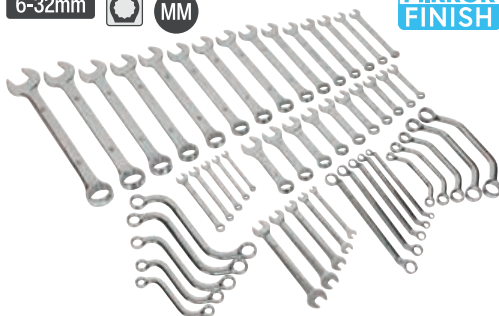

- Drop-forged Chrome Vanadium steel spanners, fully polished with a mirror finish.
- Hardened and tempered for corrosion resistance.
- Contents: Combination Spanners with WallDrive® Rings (x20), Stubby Combination Spanners with WallDrive® Rings (x10), Double End Half-Moon Spanners with WallDrive® Rings (x5), S-Spanners with WallDrive® Rings (x5), Deep Offset Spanners with 12-point Rings (x5), Double Open-End Spanners (x5).
- Supplied in storage/carry rack.
- **Model No. S01084**
- List Price £169.95

£119.95 Exc. VAT

£143.94 Inc. VAT

14pc Stubby Combination Spanner Set

Siegen

Stubby

6-19mm



MM



- Drop-forged Chrome Vanadium steel combination spanners heat treated and chrome plated for corrosion resistance.
- Open-end and 12-point WallDrive® ring combination.
- Sizes: 6-19mm.
- Supplied in storage tray.
- **Model No. S01232**
- List Price £37.45

£23.95 Exc. VAT

£28.74 Inc. VAT

32pc Combination Spanner Set Metric/Imperial

Siegen

6-19mm

1/4"-7/8"



MM & IMP



- Open-end and 12-point WallDrive® ring combination.
- Metric Sizes Combination Spanners; 6-19mm, Stubby Spanner sizes; 10-15mm.
- AF Sizes Combination Spanners; 1/4"-7/8", Stubby Spanner Sizes; 3/8"-5/8".
- Supplied in EVA foam storage tray.
- **Model No. S01239**
- List Price £79.95

£49.95 Exc. VAT

£59.94 Inc. VAT

4-in-1 Reversible Ratchet Ring Spanner Premier Black



Reversible 72-Tooth

10 x 13mm

17 x 19mm

MM



- Manufactured from Chrome Vanadium steel, hardened and tempered with a fully polished black chrome finish.
- Innovative ring design allows four different sizes on one spanner.
- 72-Tooth ratchet rings require only 5° rotation to pick up the next tooth, ideal for applications where space is limited.
- Size Coverage: 10 x 13, 17 x 19mm.
- Model No. AK7979
- List Price £46.95

£24.95 Exc. VAT
£29.94 Inc. VAT

5pc TRX-Star* Double End Spanner Set Premier



E6 - E24

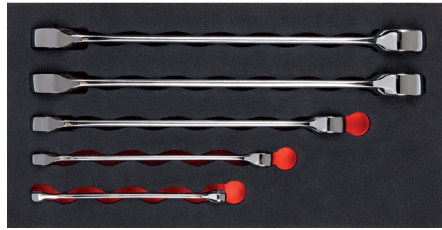

- Hardened and tempered with a fully polished mirror finish for resistance to corrosion.
- Five spanners covering 10 sizes of TRX-Star* fixings.
- Sizes: E6 x E8, E10 x E12, E14 x E16, E18 x E20, E22 x E24.
- Supplied in EVA foam storage tray.
- Model No. AK5481
- List Price £34.95

£19.95 Exc. VAT
£23.94 Inc. VAT

16pc 3/8" Sq Drive TRX-Star* Socket & Spanner Set Premier



3/8" Sq Drive

E4 - E24



- Manufactured from Chrome Vanadium steel with a fully polished finish for corrosion resistance.
- 12 x 3/8" Sq Drive sockets covering sizes E4-E20 and four double end spanners covering TRX-Star* fixings E6-E24.
- Knurled ring on sockets for extra grip.
- Supplied in EVA foam storage tray.
- Model No. AK61801
- List Price £53.95

£34.95 Exc. VAT
£41.94 Inc. VAT

12pc Stubby Ratchet Combination Spanner Set Siegen



Stubby 72-Tooth 8-19mm

MM



- Chrome Vanadium steel stubby ratchet combination spanner set.
- 72-Tooth ratchet ring and gear set requiring only 5° rotation to pick up the next tooth, ideal for applications where space is limited.
- Sizes: 8, 9, 10, 11, 12, 13, 14, 15, 16, 17, 18, 19mm.
- Supplied in storage/carry rack.
- Model No. S0633
- List Price £86.95

£49.95 Exc. VAT
£59.94 Inc. VAT

12pc Combination Ratchet Spanner Set Siegen



72-Tooth 8-19mm

MM

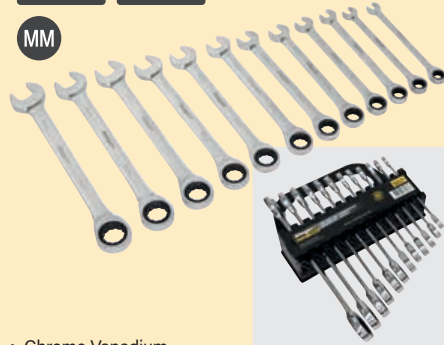

- Chrome Vanadium steel ratchet combination spanner set.
- 72-Tooth ratchet ring and gear set requiring only 5° rotation to pick up the next tooth, ideal for applications where space is limited.
- Sizes: 8, 9, 10, 11, 12, 13, 14, 15, 16, 17, 18, 19mm.
- Supplied in storage/carry rack.
- Model No. S0634
- List Price £97.95

£54.95 Exc. VAT
£65.94 Inc. VAT

12pc Flexi-Head Combination Ratchet Spanner Set Siegen



Flexi-Head 72-Tooth 8-19mm

MM



- Chrome Vanadium steel flexi-head ratchet combination spanner set.
- 72-Tooth ratchet ring and gear set requiring only 5° rotation to pick up the next tooth, ideal for applications where space is limited.
- Sizes: 8, 9, 10, 11, 12, 13, 14, 15, 16, 17, 18, 19mm.
- Supplied in storage/carry rack.
- Model No. S0635
- List Price £112.45

£69.95 Exc. VAT
£83.94 Inc. VAT

17pc Combination Ratchet Spanner Set Siegen



72-Tooth 8-32mm

MM



- Chrome Vanadium steel ratchet combination spanner set.
- 72-Tooth ratchet ring and gear set requiring only 5° rotation to pick up the next tooth, ideal for applications where space is limited.
- Sizes: 8, 9, 10, 11, 12, 13, 14, 15, 16, 17, 18, 19, 22, 24, 27, 30, 32mm.
- Supplied in storage/hanging pouch.
- Model No. S01156
- List Price £176.95

£112.95 Exc. VAT
£135.54 Inc. VAT

Ratchet Spanner Sets - Premier Platinum

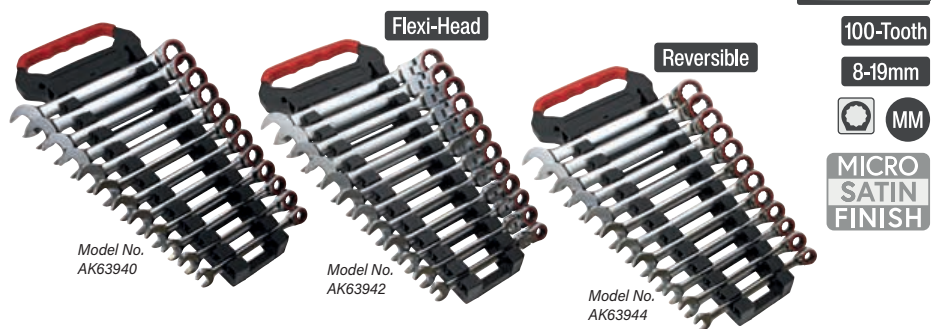

- High quality slim style Chrome Vanadium steel spanners.
- Hardened and tempered with a fully polished micro satin finish.
- Ultra-smooth 100-Tooth WallDrive® ratchet ring.

Model No.	Qty	Type	Contents	List Price	Exc. VAT	Inc. VAT
AK63940	12pc	Combination	8, 9, 10, 11, 12, 13, 14, 15, 16, 17, 18, 19mm	£149.95	£99.95	£119.94
AK63942	12pc	Flexi-Head Combination	8, 9, 10, 11, 12, 13, 14, 15, 16, 17, 18, 19mm	£249.95	£159.95	£191.94
AK63943	7pc	Flexi-Head Combination	8, 10, 12, 13, 14, 17, 19mm	£136.95	£79.95	£95.94
AK63944	12pc	Reversible Combination	8, 9, 10, 11, 12, 13, 14, 15, 16, 17, 18, 19mm	£207.95	£129.95	£155.94
AK63945	7pc	Reversible Combination	8, 10, 12, 13, 14, 17, 19mm	£109.95	£69.95	£83.94

32pc Precision Bit Screwdriver Set



- Manufactured from S2 steel and chrome plated to provide increased protection against corrosion and wear.
- Range of popular bits suitable for general workshop use.
- Contents: 30mm Bits; Slotted - 1, 1.5, 2, 2.5, 3, 3.5, 4mm, Phillips - #000, #00, #0, #1, Pozi - #0, #1, TRX-Star* - T4, T5, T6, T7, T8, T9, T10, T15, T20, Hex - 0.7, 0.9, 1.3, 1.5, 2, 2.5, 3, 4mm, 115mm Bit Adaptor, 105mm Driver Handle.
- **Model No. AK97328**
- List Price £15.95

£10.95 Exc. VAT
£13.14 Inc. VAT

8pc TRX-Star* Screwdriver Set



- Hardened and tempered Chrome Vanadium steel shafts with a satin finish.
- Shot blasted and magnetized tips.
- Contoured soft grip handles with colour-coding for fast identification.
- Sizes: T8 x 75, T10 x 75, T15 x 100, T20 x 100, T25 x 100, T27 x 100, T30 x 125, T40 x 125mm.
- **Model No. S0897**
- List Price £17.95

£11.95 Exc. VAT
£14.34 Inc. VAT

21pc Screwdriver Set with Storage Case



- Selection of popular sized screwdrivers, bit driver and bits.
- Chrome Vanadium steel satin finish shafts with shot blasted and magnetized tips.
- Contoured soft grip handles with colour-coding for fast identification.
- Contents: Slotted; 6 x 150, 8 x 150mm, Phillips; #1 x 75, #2 x 100mm, Pozi; #1 x 75, #2 x 100mm, Bit Holder, Bits; Slotted - 4, 5mm, Phillips - #3, Pozi - #3, TRX-Star* - T15, T20, T25, Hex - 2, 2.5, 3, 4, 5, 5.5, 6mm.
- **Model No. S0923**
- List Price £24.95

£17.95 Exc. VAT
£21.54 Inc. VAT

24pc Soft Grip Screwdriver Set



- Chrome Vanadium steel shafts with satin finish.
- Contents: Slotted; 6 x 38, 3 x 75, 4 x 100, 5 x 100, 6 x 100, 5 x 150, 6 x 150, 8 x 200mm, Phillips; #0 x 75, #1 x 75, #2 x 38, #2 x 100, #3 x 150mm, Pozi; #0 x 75, #2 x 100mm, TRX-Star*; T10 x 100, T15 x 100, T20 x 100, T25 x 100, T30 x 100mm, Tack Puller, Scratch Awl, Bit Driver, Magnetizer/Demagnetizer.
- **Model No. S0617**
- List Price £49.95

£29.95 Exc. VAT
£35.94 Inc. VAT

PowerMAX® Screwdriver Sets



Model No. AK4332

Model No. AK4333



- High quality S2 steel, satin finished shafts with shot blasted and magnetized tips.
- Features distinctive driver type marking for fast identification and hanging hole for alternative storage.

Model No.	Qty	Contents	List Price	Exc. VAT	Inc. VAT
AK4332	11pc	Slotted; 3 x 75, 5 x 125, 6 x 150, 8 x 150mm, Phillips; #1 x 80, #2 x 100mm, Pozi: #1 x 80, #2 x 100mm, VDE Screwdrivers - Slotted; 4 x 100mm, Phillips; #1 x 80mm, 110-480mm Telescopic Magnetic Pick-Up Tool	£45.95	£17.95	£21.54
AK4333	21pc	Slotted; 6 x 150, 8 x 150mm, Phillips; #1 x 75, #2 x 100mm, Bit Holder, Bits - Slotted; 4, 5mm, Phillips; #3, Pozi; #3, TRX-Star*; T15, T20, T25, Hex; 2, 2.5, 3, 4, 5, 5.5, 6mm	£34.95	£14.95	£17.94

Precision Screwdriver Sets



- High quality S2 steel shafts with shot blasted and blackened tips.
- Contoured handle with soft rubber grip for added control, includes hanging holes.
- Spinner top enables fingertip control of driver.



Model No. AK97326

Model No.	Qty	Contents	List Price	Exc. VAT	Inc. VAT
AK97324	6pc	Slotted; 2, 2.5, 3mm, Phillips; #000, #00, #0	£14.95	£9.95	£11.94
AK97325	6pc	TRX-Star*; T6, Security TRX-Star*; T7H, T8H, T9H, T10H, T15H	£15.95	£9.95	£11.94
AK97326	15pc	Slotted; 1.5, 2, 2.5, 3mm, Phillips; #000, #00, #0, #1, TRX-Star*; T5, T6, Security TRX-Star*; T7H, T8H, T9H, T10H, T15H	£32.95	£19.95	£23.94
AK97327	25pc	Slotted; 1.5, 2, 2.5, 3, 3.5, 4mm, Phillips; #000, #00, #1 x 3.5, #1 x 4, Hex; 1.5, 2, 2.5, 3, 3.5, 4, 4.5mm, TRX-Star*; T5, T6, T7, T8, T9, T10, T15	£49.95	£31.95	£38.34



Model No. AK97327

6pc Hammer-Thru Screwdriver Sets



Premier



- High quality Chrome Vanadium steel satin finished shafts with shot blasted and magnetized tips.
- Features hexagonal bolster for use with a wrench.
- Contoured, textured soft-grip handles with hammer caps.
- Contents: Slotted; 5 x 100, 6 x 150, 8 x 175mm, Phillips; #1 x 75, #2 x 100, #3 x 150mm.

Model No.	Colour	List Price	Exc. VAT	Inc. VAT
AK4940	Red	£47.95	£22.95	£27.54
AK4940HV	Green	£47.95	£22.95	£27.54

9pc Hammer-Thru Screwdriver Sets



Premier



- High quality Chrome Vanadium steel satin finished shafts with shot blasted and magnetized tips.
- Features hexagonal bolster for use with a wrench.
- Contoured, textured soft-grip handles with hammer caps.
- Contents: Slotted; 5 x 100, 6 x 150, 8 x 175mm, Phillips; #1 x 75, #2 x 100, #3 x 150mm, Pozi; #1 x 75, #2 x 100, #3 x 150mm.

Model No.	Colour	List Price	Exc. VAT	Inc. VAT
AK4941	Red	£72.95	£36.95	£44.34
AK4941HV	Green	£72.95	£36.95	£44.34

3pc 450mm Extra-Long Hammer-Thru Screwdriver Sets



Premier



450mm Length

Extra-Long

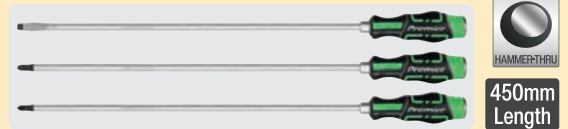
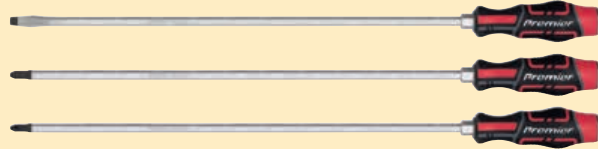

- High quality Chrome Vanadium steel extra-long satin finished shafts with shot blasted and magnetized tips.
- Features hexagonal bolster for use with a wrench.
- Contoured, textured soft-grip handles with hammer caps.
- Contents: Slotted; 8 x 450mm, Phillips; #2 x 450, #3 x 450mm.

Model No.	Colour	List Price	Exc. VAT	Inc. VAT
AK4942	Red	£46.95	£22.95	£27.54
AK4942HV	Green	£46.95	£22.95	£27.54

44pc Screwdriver, Hex Key & Bit Sets



Siegen



Model No. S01090

- Selection of popular sized screwdrivers, hex keys, bit driver and bits.
- Chrome Vanadium satin finish shafts with shot blasted and magnetized tips.
- Contoured soft grip handles with colour-coding for fast identification.

Model No.	Hammer Thru	List Price	Exc. VAT	Inc. VAT
S01090	X	£45.95	£28.95	£34.74
S01106	✓	£57.95	£36.95	£44.34



Model No. S01106

100pc Screwdriver, Bit & Nut Driver Set



Siegen



- Selection of popular sized screwdrivers, nut drivers, bit driver and 60 bits.
- Chrome Vanadium satin finish shafts with shot blasted and magnetized tips.
- Contoured soft grip handles with colour-coding for fast identification.
- Supplied with wall mountable display stand which features a built-in magnetizer/demagnetizer.
- Model No. S01248
- List Price £62.95

£44.95	Exc. VAT
£53.94	Inc. VAT

Magnetic Bit Holders

Magnetic



- Manufactured from Chrome Vanadium steel.
- Drive: 1/4"Hex(M) - 1/4"Hex(F).

Model No.	Description	List Price	Exc. VAT	Inc. VAT
AK49251	150mm Quick Chuck Magnetic Bit Holder	£7.95	£5.95	£7.14
AK49252	300mm Magnetic Bit Holder	£18.95	£11.95	£14.34
AK4926	2-in-1 Quick Chuck Bit & Socket Holder	£7.95	£5.95	£7.14
AK4927	Magnetic Bit Holder	£5.95	£4.95	£5.94
AK4930	20° Pivoting Magnetic Bit Holder	£8.95	£6.95	£8.34

Premier

4pc Impact Grade Power Tool Bit Holder Set

Premier

NEW Product

Magnetic



- Impact grade power tool bit holders for the professional user.
- Specially heat treated CNC precision machined tips reduce stress and prevent cam-out under load.
- Torsion bits absorb impact and transfer maximum torque to the fixing.
- 4-Piece kit includes: Magnetic Impact Bit Holders; 60, 150mm, Pozi; #2 (x2).
- **Model No. AK8276**
- List Price £8.95

£6.95 Exc. VAT
£8.34 Inc. VAT

Fine Tooth Ratchet Screwdriver Socket & Bit Sets

Standard



Model No. AK64905

- Fine tooth reversible ratchet driver with soft comfort grip handle and integral bit storage.
- See www.sealey.co.uk for full contents and details.

Model No.	Qty	Type	List Price	Exc. VAT	Inc. VAT
AK64905	38pc	Standard	£36.45	£19.95	£23.94
AK64906	24pc	Stubby	£23.95	£13.95	£16.74

Stubby



Model No. AK64906



Premier

38pc 1/4" Sq Drive Socket & Bit Set

Premier

1/4" Sq Drive



- Manufactured from high quality Chrome Vanadium steel.
- Hardened and tempered sockets and accessories with a fully polished finish for resistance to corrosion.
- Features 48-tooth flip reverse comfort grip ratchet wrench with push-button quick release, spinner handle, extension bars, universal joint and bit adaptor.
- Contents: Slotted; 3, 4, 5, 6, Phillips; #1, #2 (x2), #3, Pozi; #1, #2, #3, Security TRX-Star*; T10H, T15H, T20H, T25H, T27H, T30H, T40H, Hex; 3, 4, 5, 6mm, 1/4" Sq Drive Sockets; 5.5, 6, 7, 8, 9, 10, 11, 12, 13, 14mm, 50, 100mm Extension Bars, 1/4" Sq Drive 48-Tooth Ratchet Wrench, Spinner Handle, Bit Coupler, Universal Joint.
- **Model No. AK8945**
- List Price £76.95

£41.95 Exc. VAT
£50.34 Inc. VAT

31pc 1/4" Sq Drive Socket & Colour-Coded Bit Set

NEW Product Premier

1/4" Sq Drive

1/4" Hex Drive



- Knurled ring sockets to assist with grip.
- Colour-coded satin chrome bits for fast identification.
- Contents: 1/4" Sq Drive Sockets; 4, 5, 6, 7, 8, 9, 10, 11, 12, 13, 14mm, 50mm Extension Bar, 1/4" Hex-1/4" Sq Drive Micro Ratchet Bit Driver/Wrench, Bits; Slotted - 4, 5, 6mm, Phillips - #1, #2, #3, Pozi - #1, #2, #3, TRX-Star* - T10, T15, T20, T25, T27, T30, Hex - 4, 5, 6mm,
- **Model No. AK2111**
- List Price £44.95

£32.95 Exc. VAT
£39.54 Inc. VAT

Claw Hammers with Fibreglass Shaft

Premier



Model No. CLHG16

Model No. CLHG20

- Manufactured from drop-forged carbon steel.
- Magnetic nail starter for easy one-hand operation.
- Fibreglass shafts with graphite core for improved strength and durability.
- Textured rubber grip for secure handling.
- Manufactured and tested to BS 876.

Model No.	Weight	List Price	Exc. VAT	Inc. VAT
CLHG16	450g(16oz)	£17.95	£11.95	£14.34
CLHG20	560g(20oz)	£18.95	£12.45	£14.94

Dead Blow Hammers

Premier



Model No. DBH01

Model No. DBH02

- Shot-loaded heads produce heavy, controlled and effective blows without rebound.
- TPR shafts and heads with soft grip handles for comfort and control.

Model No.	Weight	List Price	Exc. VAT	Inc. VAT
DBH01	794g(1.75lb)	£21.45	£14.95	£17.94
DBH02	1270g(2.8lb)	£27.95	£18.95	£22.74

Ball Pein Hammers with Fibreglass Shaft

Premier



Model No. BPHG16

Model No. BPHG24

- Manufactured from drop-forged carbon steel.
- Fibreglass shafts with graphite core for improved strength and durability.
- Textured rubber grip for secure handling.
- Manufactured and tested to BS 876.

Model No.	Weight	List Price	Exc. VAT	Inc. VAT
BPHG16	450g(16oz)	£18.95	£12.95	£15.54
BPHG24	680g(24oz)	£21.95	£14.95	£17.94

8pc Impact Driver Set

Premier



- Professional 1/2" Sq drive impact driver with contoured grip and phosphate finish.
- Features twist-reverse for operation in either direction.
- Supplied with 6-piece Chrome Vanadium steel driver bit set and 8mm hex drive adaptor.
- Driver Bits: 8mm Bits (35mm Long); Slotted - 8, 10mm, Phillips - #2, #3, 8mm Bits (80mm Long); Phillips - #2, #3.
- Model No. AK2085
- List Price £42.95

£24.95 Exc. VAT
£29.94 Inc. VAT

10pc Heavy-Duty Impact Driver Set with Protection Grip

Premier



- Heavy-duty 1/2" Sq drive impact driver.
- Composite handle with integral knuckle guard.
- Twist-reverse for operation in either direction.
- Hammer-through cap.
- Supplied in storage case.
- Driver Bits: 36mm, 80mm Long; Slotted - 8, 10mm, Phillips - #2, #3.
- Model No. AK2084
- List Price £54.95

£34.95 Exc. VAT
£41.94 Inc. VAT

4pc Heavy-Duty Pry Bar Set with Hammer Cap

Premier



- Heavy-duty, angled shafts.
- Chrome Molybdenum steel with blackened finish.
- Comfortable soft grip handles with hammer cap.
- Contents: 200, 300, 460, 610mm.
- Model No. AK9105
- List Price £77.95

£43.95 Exc. VAT
£52.74 Inc. VAT

900mm Heavy-Duty Pry Bars with Hammer Cap

Premier



- Chrome Molybdenum 16mm steel shafts with satin chrome finish and comfortable soft grip handles with hammer cap.
- 900mm x 16mm Square.

Model No.	Type	List Price	Exc. VAT	Inc. VAT
AK9103	Straight	£67.95	£39.95	£47.94
AK9104	25°	£68.95	£39.95	£47.94

4pc Heavy-Duty Pry Bar Set with Hammer Cap

Premier



- Manufactured from 16mm square Chrome Molybdenum steel.
- Extra-heavy-duty pry bar set with comfortable soft grip handles and hammer cap.
- Set comprises: 900mm/Straight, 900mm/25°, 600mm/75°, 600mm/90°.
- Supplied in storage case.
- Model No. AK9100
- List Price £269.95

£159.95 Exc. VAT
£191.94 Inc. VAT

3/8" Sq Drive Socket Bit Sets

MIRROR FINISH

3/8" Sq Drive

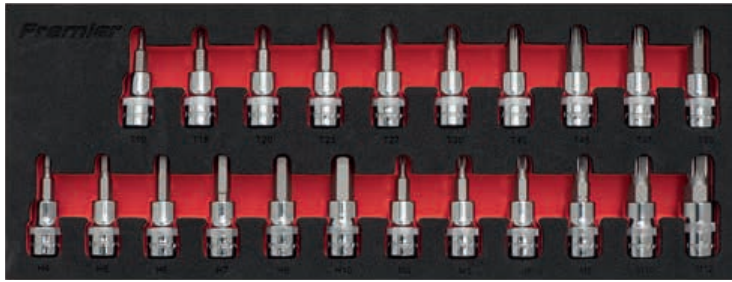

A
4-12mm

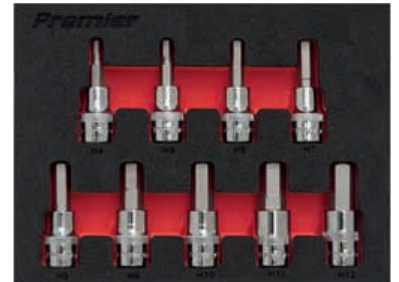

B

T10 - T50

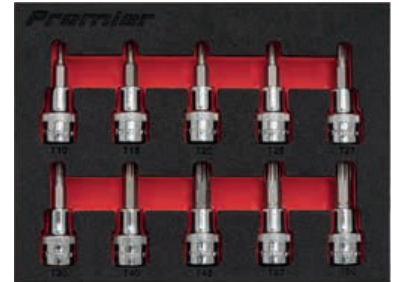

- Forged Chrome Vanadium steel sockets with S2 steel hex bits.
- Sockets are heat treated and chrome plated with a fully polished mirror finish.
- Knurled rings assist the gripping of the sockets with oily fingers.

Ref.	Model No.	Qty	Drive	Contents	List Price	Exc. VAT	Inc. VAT
A	AK6240	9pc	3/8" Sq	Hex - 4, 5, 6, 7, 8, 9, 10, 11, 12mm	£30.95	£19.95	£23.94
B	AK6242	10pc	3/8" Sq	TRX-Star* - T10, T15, T20, T25, T27, T30, T40, T45, T47, T50	£33.95	£21.95	£26.34
C	AK6243	22pc	3/8" Sq	Spline - M4, M5, M6, M8, M10, M12, TRX-Star* - T10, T15, T20, T25, T27, T30, T40, T45, T47, T50, Hex - 4, 5, 6, 7, 8, 10mm	£64.95	£39.95	£47.94

9pc Stubby Element Extra-Long Hex Key Set

Premier

Stubby Extra-Long 1.5-10mm

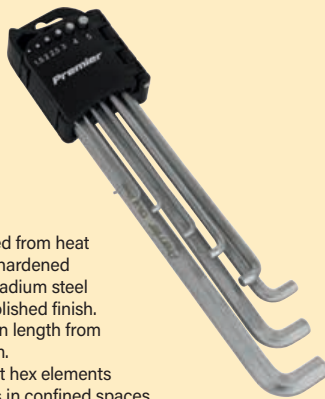

- Manufactured from heat treated and hardened Chrome Vanadium steel with satin polished finish.
- Keys range in length from 90 to 230mm.
- Stubby offset hex elements allow access in confined spaces.
- Sizes: 1.5-10mm.
- Supplied in easy-access case for safe storage and quick key selection.

• Model No. AK7174

• List Price £22.45

£14.95 Exc. VAT
£17.94 Inc. VAT

27pc Master Hex Key Set

Premier

T10 - T50

1/16"-3/8"

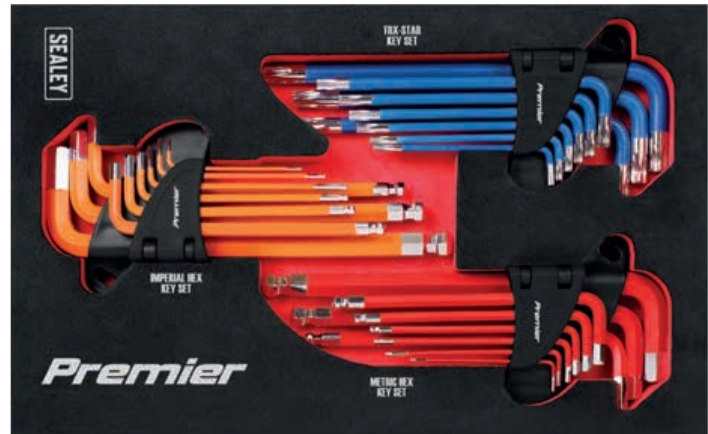

- Manufactured from heat treated and hardened Chrome Vanadium steel with a fully polished finish.
- Anti-slip coating for comfort and control.
- Each key set is supplied in easy-access case for safe storage and quick key selection.
- Supplied in an EVA storage tray.

• Model No. AK7179

• List Price £62.45

£36.95 Exc. VAT
£44.34 Inc. VAT

13pc Anti-Slip Jumbo TRX-Star* Key Set

Premier

Anti-Slip

Jumbo Keys

Extra-Long

T10 - T80

Magnetic



- Manufactured from heat treated and hardened Chrome Vanadium steel with a fully polished finish.
- Keys range in length from 75 to 270mm and in size from T10 to T80.
- Anti-slip coating for comfort and control.
- Includes magnets on the long element.
- Supplied in easy-access case for safe storage and quick key selection.

• Model No. AK7188

• List Price £109.95

£67.95 Exc. VAT
£81.54 Inc. VAT

13pc Anti-Slip Jumbo Ball-End Hex Key Sets

Premier

Anti-Slip Jumbo Keys Magnetic

2-19mm



Model No. AK7187

5/64"-3/4"

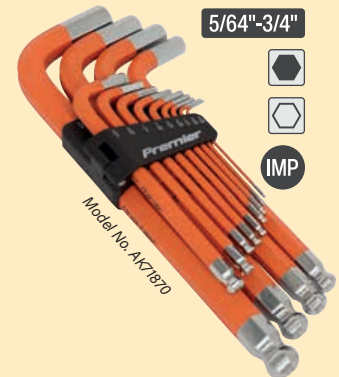

Model No. AK7189

- Manufactured from heat treated and hardened Chrome Vanadium steel with a fully polished finish.
- Anti-slip coating for comfort and control.
- Includes magnets on the long element.
- Supplied in easy-access case for safe storage and quick key selection.

Model No.	Type	Contents	List Price	Exc. VAT	Inc. VAT
AK7187	Ball-End Hex - Metric	2-19mm	£98.95	£64.95	£77.94
AK7189	Ball-End Hex - Imperial	5/64"-3/4"	£98.95	£64.95	£77.94

3pc Locking Pliers Set

NEW Product Premier



- Heat treated Chrome Vanadium steel construction with a smooth satin finish.
- Deeply serrated and hardened teeth grip the workpiece from any angle.
- Curved jaw design applies maximum pressure to all four corners of nut or bolt head, making it ideal for high torque applications.
- Heavily knurled adjustment screw for extra grip.
- Jaw Capacity/Length: 125mm Curved Jaw (30mm Jaw Capacity), 250mm Curved Jaw (45mm Jaw Capacity), 230mm Long Nose Pliers (70mm Jaw Capacity).

£29.95 Exc. VAT
£35.94 Inc. VAT

- Supplied in storage pouch.
- **Model No. AK6876**
- List Price £42.95

10pc Locking Pliers Set

Premier

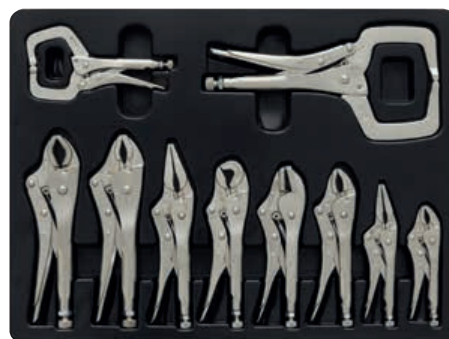

- Hardened and tempered, drop-forged Chrome Vanadium steel jaws with a combination of profiles.
- Deep-cut jaw faces assist grip.
- Knurled jaw adjustment screw and flip release mechanism.
- Nickel-plated smooth satin finish.
- Sizes: Curved Jaw; 125, 175, 250mm, Long Nose Jaw; 175, 225mm, Straight Jaw; 175mm, Round Jaw; 175mm, X Jaw; 250mm, C-Clamp; 150, 275mm.

£119.95 Exc. VAT
£143.94 Inc. VAT

- Supplied in a storage tray.
- **Model No. AK6800**
- List Price £149.95

6pc Mini Pliers Set

Premier



- Manufactured from hardened and tempered drop-forged Chrome Vanadium steel.
- Finely ground polished heads.
- Serrated jaws and precision ground cutting edges, induction-hardened 55-65 HRC for cutting hard and soft wires.
- Dual material comfort grip handles.
- Contents: 105mm End Cutters, 115mm Side Cutters, 115mm Combination Pliers, 125mm Bent Nose Pliers, 125mm Long Nose Pliers, 145mm Needle Nose Pliers.

£29.95 Exc. VAT
£35.94 Inc. VAT

- **Model No. AK8381**
- List Price £43.95

3pc High Leverage Pliers Sets

Premier



Model No. AK8376HV

- Manufactured from hardened and tempered drop-forged Chrome Vanadium steel.
- Finely ground polished heads.
- Serrated jaws and precision ground cutting edges, induction-hardened 55-65 HRC for cutting hard and soft wires.
- Dual material comfort grip handles and black oxide finish for corrosion protection.
- Contents: 200mm Long Nose Pliers, 175mm Combination Pliers, 160mm Side Cutters.

Model No.	Colour	List Price	Exc. VAT	Inc. VAT
AK8376	Red	£51.95	£34.95	£41.94
AK8376HV	Green	£51.95	£34.95	£41.94

3pc High Leverage Pliers Set

Premier



- Manufactured from hardened and tempered drop-forged Chrome Vanadium steel.
- Finely ground polished heads.
- Serrated jaws and precision ground cutting edges, induction-hardened 55-65 HRC for cutting hard and soft wires.
- Unique teeth and jaw design on water pump pliers increases torque and grips round, flat, square and hex profiles.
- Dual material comfort grip handles and black oxide finish for corrosion resistance.
- Contents: 190mm Heavy-Duty Side Cutters, 200mm Combination Pliers, 250mm Water Pump Pliers.

£36.95 Exc. VAT
£44.34 Inc. VAT

- **Model No. AK8377**
- List Price £62.95

3pc Quick Release Locking Pliers Set Premier Black

Premier Black Quick Release

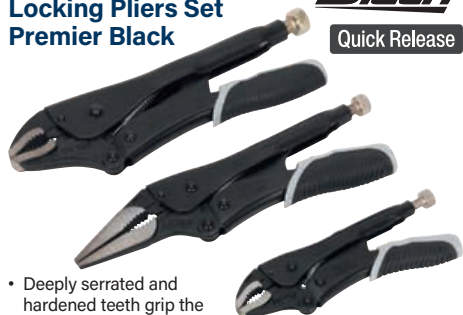

- Deeply serrated and hardened teeth grip the workpiece from any angle.
- Curved jaw design applies maximum pressure to all four corners of nut or bolt heads making it ideal for high torque applications.
- Feature one-hand, no-pinch, quick release grip.
- Heavily knurled nickel plated adjustment screw for extra grip with greasy fingers.
- Jaw Capacity/Length: Curved Jaw - 30/140, 45/220mm, Long Nose - 60/210mm.

£47.95 Exc. VAT
£57.54 Inc. VAT

- Supplied in EVA storage tray.
- **Model No. AK6863B**
- List Price £71.95

Plier Racks

Model No. PR01

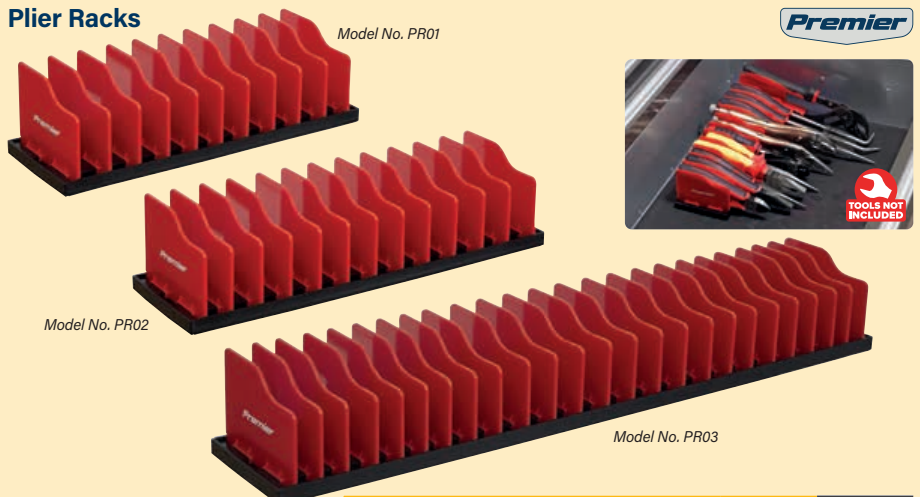

Model No. PR02

Model No. PR03

- Adjustable rigid dividers for the organised storage of a wide variety of pliers.
- Manufactured from ABS plastic.
- Ideal for using in tool chest drawers.

Model No.	Capacity	Length	List Price	Exc. VAT	Inc. VAT
PR01	10	250mm	£22.95	£13.95	£16.74
PR02	12	300mm	£28.95	£15.95	£19.14
PR03	24	520mm	£43.95	£24.95	£29.94

Locking Pocket Knife Twin-Blade

Premier

Quick Change Blade

LIFETIME GUARANTEE*



- Manufactured from high quality stainless steel.
- Fully hardened and tempered for long-life.
- Lightweight two-tone aluminium handle construction.
- Features both utility and fine edge blades.
- Push-button locking mechanism secures blades in both open and closed position.
- Closed/Open Length: 110/180mm.
- Quick change mechanism for easy blade removal/fitting - no tools required.
- **Model No. PK37**
- List Price £22.45

£13.95 Exc. VAT
£16.74 Inc. VAT

Locking Pocket Knife

Premier

Quick Change Blade

LIFETIME GUARANTEE*



- Manufactured from high quality stainless steel.
- Fully hardened and tempered for long-life.
- Lightweight two-tone aluminium handle construction.
- Push-button locking mechanism secures blade in both open and closed position.
- Quick change mechanism for easy blade removal/fitting - no tools required.
- **Model No. PK38**
- List Price £17.95

£12.95 Exc. VAT
£15.54 Inc. VAT

14-Function Multi-Tool

Premier

NEW Product

LIFETIME GUARANTEE*



- 14 Tools in one.
- Manufactured from high quality stainless steel.
- Fully hardened and tempered for long-life.
- Lightweight aluminium handle construction.
- Multi-tool functions include pliers, wire cutters, slotted screwdrivers, Phillips screwdriver, double file, leather punch, fish scaler, hook remover, knife, can and bottle opener.
- Ideal for camping and leisure activities.
- **Model No. PK39**
- List Price £24.95

£17.95 Exc. VAT
£21.54 Inc. VAT

8pc Hammer-Thru Wood Chisel Set

Premier

HEAVY DUTY



MM

ALWAYS WEAR SAFETY GOGGLES WHEN USING THESE TOOLS



- Chrome Vanadium steel.
- Bevel edged blades.
- Full length hammer-thru shafts with striking cap.
- Contoured handles with soft grips for added comfort and control.
- Supplied in storage case.
- Contents: Chisels; 6, 12, 19, 25, 32, 38mm, 203mm Sharpening Stone, Honing Guide.
- **Model No. AK9240**
- List Price £57.95

£36.95 Exc. VAT
£44.34 Inc. VAT

3pc Scraper Set with Hammer Cap

Siegen

LIFETIME GUARANTEE*



- 1.8mm Ultra-stiff stainless steel scraper blades suitable for numerous workshop and bodyshop applications.
- Soft grip handles and broad hilt design give maximum control.
- Cap permits careful use with hammer.
- Contents: Scrapers; 32mm, 50mm, 32mm Angled Scraper (20°).
- **Model No. S0856**
- List Price £19.95

£12.95 Exc. VAT
£15.54 Inc. VAT

3-In-1 Interchangeable Propane Torch Set

Premier

3 YEAR GUARANTEE*



- Supplied with three interchangeable heads: Pin-point flame - for precision/small soldering jobs, Soft flame - medium heat for shrinking and heating on larger applications such as metal manipulation, Swirling flame - for brazing and soft soldering.
- Fitted with heavy-duty piezoelectric ignition, safety lock and continuous flame switch.
- Precision heat control with fine gas pressure adjustment.
- Suitable for CGA600 propane gas fuel types.
- Flame temperature: 1800°C to 2200°C.
- **Model No. AK2958**
- List Price £129.95

£99.95 Exc. VAT
£119.94 Inc. VAT

Micro Butane Heating Torch

Premier

3 YEAR GUARANTEE*



- Professional micro design featuring piezoelectric ignition.
- Fitted with automatic safety lock.
- Unit produces flame of up to 1300°C and will operate for up to 45 minutes on a single fill.
- Features adjustable flame control and continuous flame function.
- Powered by Butane (lighter fuel).
- **Model No. AK2973**
- List Price £29.95

£19.95 Exc. VAT
£23.94 Inc. VAT

Heavy-Duty Butane Indexing Soldering Torch

Premier

3 YEAR GUARANTEE*



- Piezoelectric ignition with anti-flare burner, safety lock and continuous flame switch.
- Fitted with three position indexing head as well as magnetic stand for hands-free operation.
- Adjustable flame with a maximum temperature of 1300°C.
- 45-60 Minute runtime with maximum 35ml fuel capacity.
- Powered by butane (lighter fuel).
- **Model No. AK2972**
- List Price £69.95

£47.95 Exc. VAT
£57.54 Inc. VAT

3-in-1 Butane Indexing Soldering Iron Kit



Premier

3 YEAR GUARANTEE*



- 3-in-1 Device that can be used for heating, soldering and shrinking.
- Powered by butane (lighter fuel) and features a piezoelectric ignition switch.
- Flame temperature 1300°C, soldering temperature 450°C and hot air temperature 600°C (approximately).
- 60-75 Minute runtime with 30ml fuel capacity.
- Kit includes soldering iron, chisel tip, anvil tip, needle tip, hot knife, deflector nozzle, lead-free solder, cleansing sponge and tip holder.
- **Model No. AK2971**
- List Price £109.95

£74.95 Exc. VAT
£89.94 Inc. VAT

76m Braided Nylon Brick Line



- 76m Long.
- Ideal for indoor or outdoor use, such as crafting, gardening, masonry and marking.
- Doesn't absorb water, reduces the likelihood of the line breaking.
- The fluorescent colour provides high visibility, so it can be used in a number of conditions.
- Braided nylon provides a strong, durable line.

Model No.	Colour	List Price	Exc. VAT	Inc. VAT
BLP1	Pink	£4.95	£3.75	£4.50
BLY1	Yellow	£4.95	£3.75	£4.50



Foam Gun for Expanding Foam Cartridges



- A top quality metal gun for use with gun grade polyurethane expanding foams.
- Screws onto the canister for quick and easy application.
- Easy adjustable flow control.
- Stainless steel barrel and needle.
- **Model No. FG001**
- List Price £21.95

£17.95 Exc. VAT
£21.54 Inc. VAT

Brick Carrier Lifting Tongs

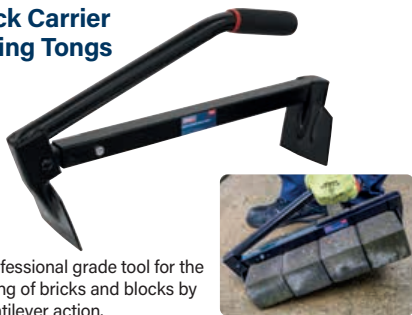

- Professional grade tool for the lifting of bricks and blocks by cantilever action.
- Easily adjustable load length, range (400-660mm).
- Able to carry between 6 and 10 bricks.
- Square tube metal construction for strength and durability.
- **Model No. SR702**
- List Price £24.95

£14.95 Exc. VAT
£17.94 Inc. VAT

1/2" x 5/8" Brick Jointer



- Carbon steel.
- Heat treated and polished.
- Double ended cranked design.
- Professional finish between brick joints.
- **Model No. SR703**
- List Price £3.45

£1.95 Exc. VAT
£2.34 Inc. VAT

Skate Wheel Joint Raker



- Specially hardened large diameter wheels.
- Easy-grip handle to make removing extra mortar fast and easy.
- Hardened nail is adjustable to achieve various depths.
- Hardened nail is replaceable with any hardened masonry nail that will fit.
- **Model No. SR705**
- List Price £11.95

£7.45 Exc. VAT
£8.94 Inc. VAT

Stainless Steel Trowels



- Ideal for use in the construction industry, when applying mortar, plaster and adhesives.
- Modern, stylish two-component rubber handles with soft grip.
- High quality stainless steel precision made blades, which are lightweight, highly durable and rust-resistant.

Model No.	Type	List Price	Exc. VAT	Inc. VAT
T0309	12mm Edging Trowel	£3.25	£2.65	£3.18
T1203	160mm Masonry Trowel	£5.75	£4.45	£5.34
T1204	180mm Bucket Trowel	£6.95	£5.45	£6.54
T1205	180mm Triangular Brick Trowel	£6.45	£4.95	£5.94
T1208	140mm Filler Trowel	£4.95	£3.95	£4.74
T1222	140mm Pointing Trowel	£5.65	£4.45	£5.34
T1225	160mm Narrow Gauging Trowel	£5.85	£4.65	£5.58
T1706	120mm Margin Trowel	£4.65	£3.75	£4.50
T1740	30 x 160mm Finishing Trowel	£4.85	£3.95	£4.74
T1802	120 x 60mm Internal Corner Trowel	£5.25	£4.25	£5.10
T1803	120 x 60mm External Corner Trowel	£5.45	£4.35	£5.22
T6701	270mm Semicircle Tooth Trowel	£9.95	£7.95	£9.54
T7800	270mm Plastering Trowel	£10.95	£8.45	£10.14
T7804	270mm Notch Trowel - 4mm	£10.25	£8.45	£10.14
T7806	270mm Notch Trowel - 6mm	£10.25	£8.45	£10.14
T7808	270mm Notch Trowel - 8mm	£10.25	£8.45	£10.14
T8012	240mm Venetian Trowel	£22.95	£18.95	£22.74

NEW Products

STAINLESS STEEL

MADE IN EUROPE

250mm Drywall Rasp



- Lightweight rasp ideal for prolonged use in drywall shaping.
- Suitable for use in smoothing and shaping wood, soft metals and plastics.
- Blade easily replaced by undoing one screw.
- Metal body with palm rest for more accurate two-handed operation.
- **Model No. DWR250**
- List Price £12.95

£8.95 Exc. VAT
£10.74 Inc. VAT

Plasterboard Cutter



- Measure, mark and cut plasterboard, gypsum, KT board and drywall.
- Integral 5m tape measure and guide edge can be used to cut straight edges and circles with ease.
- Can either use pencil for marking, or retractable blade for cutting.
- Supplied with spare blades (Model No. AK86/B) in handle compartment, and a carpenter's pencil.
- **Model No. AK860CT**
- List Price £25.95

£17.95 Exc. VAT
£21.54 Inc. VAT

Handsaws 7tpi



- ABS and TPR anti-slip soft grip handles with finger rest for comfort and control.
- 1mm 65Mn High grade carbon steel blades.
- Hardened and tempered double ground teeth for fast and efficient cutting.
- Laquered coating for reduced friction and corrosion resistance.
- 45° And 90° angle guides integrated into handles.
- General-purpose 7tpi blade suitable for timber, hardwood, MDF, chipboard and plastics.

Model No.	Blade Length	List Price	Exc. VAT	Inc. VAT
AK8653	380mm	£10.45	£7.45	£8.94
AK8654	500mm	£10.95	£7.95	£9.54
AK8655	550mm	£10.95	£7.95	£9.54

Box Beam Spirit Levels

Model No. AK9866



- 1mm Aluminium box beam section levels.
- Powder coated for corrosion resistance.
- Accuracy 1mm in 1m (0.057°).
- These models include UV resistant and shockproof vials, one horizontal with side view, one vertical and one 45°.
- Precision milled face on top and bottom.

Model No.	Length	List Price	Exc. VAT	Inc. VAT
AK9866	600mm	£19.95	£11.95	£14.34
AK9867	900mm	£26.95	£13.95	£16.74
AK9868	1200mm	£28.95	£15.95	£19.14

Tape Measures - Metric/Imperial

Triple Blade Locks Metric/Imperial Scale



- High-visibility composite case with rubber cover, wrist strap and belt clip.
- Steel blade with Metric and Imperial scale and magnetic tip.
- Strong rewind mechanism with slide-button lock plus side and base mounted push-button locks for added versatility.

Model No.	Tape Length	Tape Width	List Price	Exc. VAT	Inc. VAT
AK988	3m(10ft)	16mm	£4.95	£3.25	£3.90
AK989	5m(16ft)	19mm	£6.75	£4.25	£5.10
AK990	7.5m(25ft)	25mm	£11.45	£7.95	£9.54

3-in-1 Metal, Voltage & Stud Detector



- Combined unit to accurately detect live or dead electricity cables, water or gas pipes and wood studs or battens with ease.
- Powered by a 9V battery (supplied).
- The detector will, with a red and green LED display and an audible signal, show the presence of metal, electricity and wooden studs or battens.
- Supplied with full instructions.
- **Model No. AK2018**
- List Price £34.95



£21.95 Exc. VAT
£26.34 Inc. VAT

580mm Slater's Ripper



- Remove and repair broken roof slates.
- Bevelled hook edges for sliding under nail head.
- Hardened and spring tempered steel.
- Tough and durable.
- Ergonomic handle design.
- **Model No. SR700**
- List Price £15.95

£11.95 Exc. VAT
£14.34 Inc. VAT

600g Roofing Hammer with Fibreglass Handle



- Balanced swing power.
- Epoxy resin reinforced connection between head and handle.
- Fibreglass core for greater strength and durability.
- Ergonomic non-slip handle.
- **Model No. SR706**
- List Price £16.95

£10.95 Exc. VAT
£13.14 Inc. VAT

Double Ended Scutch Hammer with Fibreglass Handle



- Perfect for chasing out walls for electrical or plumbing installations.
- Built to last, with replaceable 25mm scutch combs or droves.
- Fitted with a fibreglass handle, making it lightweight.
- **Model No. SR707**
- List Price £16.45

£10.95 Exc. VAT
£13.14 Inc. VAT

Railroad Pick Axe with Fibreglass Handle



- Forged steel body.
- Chisel end for breaking hard ground.
- Pointed end for breaking light concrete.
- Fibreglass handle.
- **Model No. SR704**
- List Price £36.95

£27.95 Exc. VAT
£33.54 Inc. VAT

Rubber Mallets with Fibreglass Shaft



- General-purpose mallets with fibreglass shaft.
- Delivers a gentle but firm blow with little rebound.

Model No.	Weight (Head)	List Price	Exc. VAT	Inc. VAT
RMB100	450g(1lb)	£13.45	£8.95	£10.74
RMB150	680g(1.5lb)	£17.45	£11.95	£14.34
RMB200	907g(2lb)	£19.95	£12.95	£15.54

Axle Stands (Pairs) **HEAVY DUTY**

3 YEAR GUARANTEE Premier

3 Tonne • Min./Max. Working Height: 290/435mm.

6 Tonne • Min./Max. Working Height: 369/571mm.

- Heavy-duty axle stands to safely support vehicles for extended periods of time.
- Large crutches for good load distribution.
- The heavy gauge steel frame and welded construction gives superior strength and safety.
- All stands feature captive, multi-position pin load support.
- The range is available in five colours, for ease of location and visual safety.

Model No. AS3G



3 Tonne Capacity per Stand				
Model No.	Colour	List Price	Exc. VAT	Inc. VAT
AS3	White	£72.95	£54.95	£65.94
AS3G	Green	£72.95	£54.95	£65.94
AS3O	Orange	£72.95	£54.95	£65.94
AS3R	Red	£72.95	£54.95	£65.94
AS3Y	Yellow	£72.95	£54.95	£65.94

6 Tonne Capacity per Stand				
Model No.	Colour	List Price	Exc. VAT	Inc. VAT
AS6	White	£124.95	£89.95	£107.94
AS6G	Green	£124.95	£89.95	£107.94
AS6O	Orange	£124.95	£89.95	£107.94
AS6R	Red	£124.95	£89.95	£107.94
AS6Y	Yellow	£124.95	£89.95	£107.94

2 Tonne Short Chassis Trolley Jacks

2 Tonne

Short Chassis



Model No. 1050CXDHV



Model No. 1050CX

- Min./Max. Saddle Height: 130/330mm.
- Chassis Length: 450mm.
- Steel chassis with welded castor supports and one-piece hydraulic unit.
- Fitted with overload valve and finger cover for extra safety.
- Includes one-piece pumping handle and carry handle.
- Model No's. 1050CXD and 1050CXDHV supplied in tough storage case.

Model No.	Colour	Storage Case	List Price	Exc. VAT	Inc. VAT
1050CX	Red	✗	£59.95	£46.95	£56.34
1050CXHV	Green	✗	£59.95	£46.95	£56.34
1050CXD	Red	✓	£64.95	£49.95	£59.94
1050CXDHV	Green	✓	£64.95	£49.95	£59.94

Jacking Pad Sets

NEW Products

Model No. JP27

Model No. JP28



- Designed for the jacking points to protect and prevent damage to jacking points, side skirts and the underside of the vehicle.
- High quality rubber, providing a sturdy and durable point of contact.
- Secure fit to vehicle, moulded to fit bespoke vehicle fitting.
- Supplied in a case for easy storage in your vehicle.

Model No.	Applications	List Price	Exc. VAT	Inc. VAT
JP27	Porsche	£19.95	£14.95	£17.94
JP28	Universal	£19.95	£14.95	£17.94

3 Tonne Cross Beam Adaptor 4x4

3 Tonne

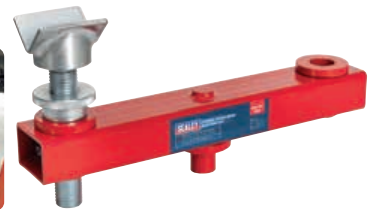

- Clever device which quickly and safely overcomes the awkward job of lifting 4x4 vehicles with offset differentials.
- Simply remove the existing trolley jack saddle, replace with cross beam adaptor, fit the jack saddle into the hole in the adaptor (30mm spigot pin) and you are ready to lift.
- Suitable for jacks with a 31-33mm saddle spigot pin.
- Minimum/Maximum Height: 140/230mm.
- **Model No. X137**
- List Price £109.95

£69.95 Exc. VAT
£83.94 Inc. VAT

3 Tonne Trolley Jack

3 Tonne



- Min./Max. Saddle Height: 130/520mm.
- Chassis Length: 659mm.
- Integral cog-type release mechanism and long 2-piece handle.
- Heavy-duty swivel castors and extra-large saddle design ease positioning under vehicle.
- Fitted with safety overload valve and pump-through valve to prevent handle locking once at maximum lift height.
- **Model No. 3000CXD**
- List Price £184.95

£154.95 Exc. VAT
£185.94 Inc. VAT

Viking Trolley Jacks with Rocket Lift

Model No. 2100TB

2 Tonne

Model No. 3100TB

3 Tonne

Model No. 4040TB

4 Tonne



Polyurethane Wheels



3 YEAR GUARANTEE



- Rocket Lift feature brings lifting arm into contact with the jacking point with minimal pumps.
- Polyurethane wheels for smoother manoeuvrability helps prevent damage to workshop floor.
- Protective jack handle sleeve helps prevent accidental damage to car bodywork when pumping the handle.
- Includes removable rubber saddle pad and built-in tool tray for fasteners and tools.
- 3 Year Guarantee - 2nd & 3rd year subject to T&C's and registration on website (www.sealey.co.uk).

Model No.	Capacity	Min./Max. Saddle Height	List Price	Exc. VAT	Inc. VAT
2100TB	2 Tonne	75/530mm	£319.95	£264.95	£317.94
3100TB	3 Tonne	95/500mm	£309.95	£259.95	£311.94
4040TB	4 Tonne	100/533mm	£319.95	£264.95	£317.94

Axle Stand Storage Racks & Combos

- Saves floor/cabinet space by enabling axle stands to be mounted securely to a wall.
- Axle stands are held firm horizontally by hooking onto cross brace, without the risk of falling.
- Model No. SR23 is suitable for Sealey axle stands such as VS2002, VS2003 and AS3 ranges.
- Model No. SR56 is suitable for Sealey axle stands AS6, AS5000, AAS5000 and VS2006 ranges.
- Both models are suitable for most other brands of axle stands.
- Supplied with wall mounting fasteners.



Model No.	Contents	List Price	Exc. VAT	Inc. VAT
SR23	2 & 3 Tonne Axle Stand Storage Racks	£24.95	£16.95	£20.34
SR56	5 & 6 Tonne Axle Stand Storage Racks	£34.95	£24.95	£29.94
VS2003COMBO NEW Product	VS2003 - Ratchet Type Axle Stands (Pair) 3 Tonne Capacity per Stand - Red, SR23 - 2 & 3 Tonne Axle Stand Storage Rack	£69.95	£49.95	£59.94
VS2003HVCOMBO NEW Product	VS2003HV - Ratchet Type Axle Stands (Pair) 3 Tonne Capacity per Stand - Green, SR23 - 2 & 3 Tonne Axle Stand Storage Rack	£69.95	£49.95	£59.94
VS2006COMBO NEW Product	VS2006 - Ratchet Type Axle Stands (Pair) 6 Tonne Capacity per Stand, SR56 - 5 & 6 Tonne Axle Stand Storage Rack	£134.95	£89.95	£107.94

Rubber Wheel Chocks - Pairs



Model No. WC01

- Sets of two rubber wheel chocks.
- Prevents vehicle movement when being jacked on a level surface or parked on an incline not exceeding 12°.

Model No.	Capacity	List Price	Exc. VAT	Inc. VAT
WC01	3 tonne	£28.95	£19.95	£23.94
WC02	5 tonne	£41.95	£29.95	£35.94

Folding Wheel Chocks - Pair



- Compact automotive wheel chocks for use during emergency wheel change.
- To be used on a flat surface only.
- Fold flat for easy storage in glove box or door pocket.
- Folded (W x D x H): 83 x 167 x 28mm (x2).
- Open: 83 x 167 x 133mm (x2).
- **Model No. WCF01**
- List Price £21.95



£16.95 Exc. VAT
£20.34 Inc. VAT

Quick Lift Vertical Transmission Jacks



- Quick Lift feature to reduce time and effort.
- Single foot pedal operation keeps hands-free during lifting process.
- Spring loaded dead man's safety release control reduces the risk of inadvertent lowering.
- 2-Way hydraulic units ensure that the saddle lowers at a controlled speed at all times, even without load.
- Hydraulic units larger than the economy models for improved performance and durability.
- Saddle is reversible allowing a jack pad to be fitted to support items other than transmissions.
- Castors and side handle for easy manoeuvrability.
- Model No. 300TRQ and Model No. 600TRQ suitable for use with Optional Adjustable Gearbox Support - Model No. ADT3.
- Model No. 1000TRQ suitable for use with Optional Adjustable Gearbox Support - Model No. ADT5.

1000kg
Max 42 Pumps to full height without Load
Model No. 1000TRQ



565kg Fuel Tank Cradle

565kg Capacity

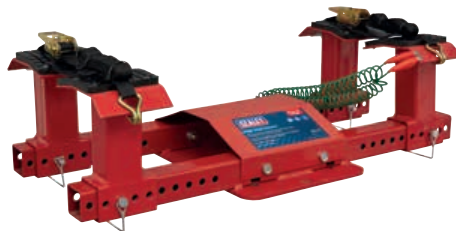

- Made for automotive and light commercial fuel tanks up to a capacity of 40 gallons (tank must be emptied before handling).
- Four adjustable support arms can be easily positioned to fit many shapes and sizes.
- Rubber pads protect the tank while being supported.
- Includes two load restraint straps.
- **Model No. FTC01**
- List Price £299.95

£249.95 Exc. VAT
£299.94 Inc. VAT

Model No.	Capacity	Min./Max. Saddle Height	Pumps to Max. Height	List Price	Exc. VAT	Inc. VAT
300TRQ	300kg	1125/1950mm	20	£489.95	£319.95	£383.94
600TRQ	600kg	1146/1986mm	22	£589.95	£429.95	£515.94
1000TRQ	1000kg	1140/1960mm	42	£759.95	£499.95	£599.94

Fuel Tank Cradle & Transmission Jack Combos

500kg Capacity OR **800kg Capacity** **2 STAGE**

Model No. FTC500COMBO Package includes:

- 500TTJ - 500kg Vertical Telescopic Transmission Jack
- FTC01 - Fuel Tank Cradle Adaptor for TTJ Transmission Jacks

Model No. FTC800COMBO Package includes:

- 800TTJ - 800kg Vertical Telescopic Transmission Jack
- FTC01 - Fuel Tank Cradle Adaptor for TTJ Transmission Jacks



These items are heavy. Extra assistance must be provided at the delivery point to help safe delivery.

Model No.	Capacity	List Price	Exc. VAT	Inc. VAT
FTC500COMBO	500kg	£1,299.95	£999.95	£1,199.94
FTC800COMBO	800kg	£1,399.95	£1,099.95	£1,319.94



18 Tonne Air Operated Bottle Jack

18 Tonne
AIR Operated



- Min./Max. Height: 260/520mm.
- Air Consumption: 9.5cfm.
- Powerful and reliable.
- Ideal for workshop or roadside use.
- Features dead man's control and sectional pump handle for manual operation.
- Takes the effort out of lifting heavy plant, tractors and commercial vehicles.
- **Model No. YAJ18S**
- List Price £319.95

£259.95 Exc. VAT
£311.94 Inc. VAT

Manual/Air Operated Bottle Jacks

Model No. AM20
20 Tonne



Model No. AM30
30 Tonne



Premier

3 YEAR GUARANTEE

AIR Operated



- Air assisted or manual operation.
- Safety overload valve.
- All steel, one-piece base, reservoir and pump cylinder.
- Both models supplied with 90° rotating pump and telescopic pump handle and have moulded carry handles incorporating storage for the pump handle.
- Serviceable ram piston with extension screw.
- Service kit available.

Model No. AM30 supplied in tough composite storage case

Model No.	Capacity	Min./Max. Height	List Price	Exc. VAT	Inc. VAT
AM20	20 Tonne	234/447mm	£699.95	£599.95	£719.94
AM30	30 Tonne	242/455mm	£849.95	£729.95	£875.94

Air Operated Jacks

Premier

3 YEAR GUARANTEE



Model No. YAJ301
30 Tonne



Model No. YAJ15-30
30 Tonne



2 STAGE

Model No. YAJ15-30LE
30 Tonne



2 STAGE

Long Reach



Model No. YAJ30H
30 Tonne



HIGH LIFT

Model No.	Capacity	Type	Low Profile	Min./Max. Height	Extensions	Max. Height (inc. Extensions)/ Capacity (mm/tonne)	List Price	Exc. VAT	Inc. VAT
YAJ301	30 Tonne	Standard	X	210/463mm	45/75mm	Stage 1: 463/30	£939.95	£799.95	£959.94
YAJ15-30	15-30 Tonne	Standard	X	176/473mm	45/75mm	Stage 1: 393/30, Stage 2: 473/15	£1,019.95	£899.95	£1,079.94
YAJ15-30LE	15-30 Tonne	Long Reach/Low Profile		150/409mm	45/75mm	Stage 1: 343/30, Stage 2: 409/15	£1,699.95	£1,399.95	£1,679.94
YAJ30H	30 Tonne	High Lift	X	360/750mm	45/100mm	Stage 1: 772/30	£2,029.95	£1,599.95	£1,919.94
YAJ10-40LELR	10-40 Tonne	Long Reach/Low Profile		130/396mm	45/75mm	Stage 1: 302/40, Stage 2: 347/20, Stage 3: 396/10	£1,769.95	£1,429.95	£1,715.94
YAJ20-60LR	20-60 Tonne	Long Reach/Low Profile		175/542mm	45/75mm	Stage 1: 377/60, Stage 2: 358/40, Stage 3: 542/10	£1,849.95	£1,499.95	£1,799.94

0.5 Tonne Low Profile Engine Crane

500kg Low Profile



- Low entry engine crane with a height of only 100mm at the wheels.
- Weighs only 37kg so is extremely lightweight and manoeuvrable.
- Heavy-duty castors and pump access from side, for safe handling of loads.
- Delivered in knock-down form to reduce freight costs, some self-assembly required.
- **Model No. PH5**
- List Price £259.95

£199.95 Exc. VAT
£239.94 Inc. VAT

2 Tonne Folding Engine Crane

2 Tonne Self Assemble



- Lifts 2000kg at 930mm jib extension.
- Folds for easy storage.
- Side pump access with removable handle.
- Delivered in knock-down form.
- Some self-assembly required.
- **Model No. PH20**
- List Price £519.95



This item is heavy. Extra assistance must be provided at the delivery point to help it's safe delivery.

£399.95 Exc. VAT
£479.94 Inc. VAT



SCAN TO DISCOVER OUR FULL RANGE OF CRANES

Creepers with Adjustable Headrest



- Heavy-duty steel.
- Powder coat paint finish.
- Ø63mm Composite castors with ball-bearing swivels.
- Vinyl covered back and headrest.
- Headrest is adjustable.
- Size (L x W x H): 1020 x 425 x 105mm.
- **Model No. SCR74**
- List Price £87.95



£67.95 Exc. VAT
£81.54 Inc. VAT

Mechanic's Creeper/Seat



- Powder coated tubular steel.
- Padded vinyl cushions.
- 5-Position head/back rest.
- Super-stable design.
- Seven Ø63mm ball-bearing swivel castors.
- Supplied flat.
- Converts to seat mode in seconds.
- Creeper Mode (L x W x H): 1180 x 435 x 115mm.
- Seat Mode (L x W x H): 615 x 435 x 610mm.
- 180kg capacity in creeper mode and 100kg capacity in seat mode.
- **Model No. SCR75**
- List Price £129.95

£99.95 Exc. VAT
£119.94 Inc. VAT

SCR10 Mechanic's Seat and Tool Tray Combo

NEW Product



- Swivel action seat.
- Lever operated pneumatic height adjustment between 390 and 520mm.
- Padded cushion for added comfort.
- Five Ø60mm ball-bearing castors.
- Base doubles as temporary storage tray.

Package includes:

- SCR10 - Pneumatic Mechanic's Seat
- SCR10 - Tool Tray for Mechanic's Seat
- **Model No. SCR10COMBO**
- List Price £69.95

£54.95 Exc. VAT
£65.94 Inc. VAT

SCR15 Mechanic's Seat and Tool Tray Combo

NEW Product

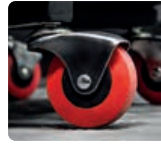

- Swivel action seat.
- Pneumatic height adjustment between 380mm and 500mm.
- Ø380mm Padded cushion.
- Five Ø60mm ball-bearing castors.
- Base doubles as temporary storage tray.

Package includes:

- SCR15 - Pneumatic Mechanic's Seat
- SCR15 - Tool Tray for Mechanic's Seat
- **Model No. SCR15COMBO**
- List Price £84.95

£74.95 Exc. VAT
£89.94 Inc. VAT

Pneumatic Workshop Stools with Adjustable Height Swivel Seats



Model No. SCR14

HEAVY DUTY



Model No. SCR17

- 4-Legged steel construction with polished chrome plate finish.
- Strengthening ring for stability which also acts as a foot rest.
- Swivel seats feature pneumatic height adjustment and rotate fully through 360°.
- Both stools are padded and Model No. SCR14 is supplied with back rest.

Model No.	Type	Height Range	List Price	Exc. VAT	Inc. VAT
SCR14	Standard	760-880mm	£134.95	£109.95	£131.94
SCR17	Heavy-Duty	695-815mm	£134.95	£109.95	£131.94

Mechanic's Utility Seat & Toolboxes



- Two folding side trays.
- Twin drinks holder and screwdriver storage rack on the rear.
- Four Ø60mm oil resistant swivel castors.
- Thick vinyl padded seat.
- Overall Size (W x D x H): 670 x 360 x 410mm.
- Max. Load: 136kg.



Model No.	Colour	List Price	Exc. VAT	Inc. VAT
SCR18B	Black	£164.95	£119.95	£143.94
SCR18G	Green	£164.95	£119.95	£143.94
SCR18O	Orange	£164.95	£119.95	£143.94
SCR18R	Red	£164.95	£119.95	£143.94

4 Tonne Modular Car Ramp Kit

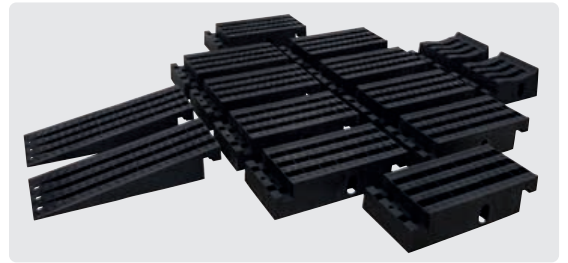

This item is heavy. Extra assistance must be provided at the delivery point to help safe delivery.

4 Tonne

Interlocking



- Modular design is ideal for portability, storage and enables user to change length.
- Manufactured from durable UV resistant polypropylene.
- Allows access to the underside of the vehicle.
- 350mm Wide ramps for a broad range of vehicles - recommended maximum tread width 290mm.
- 4 Tonne Maximum capacity - 2 Tonne per ramp.
- Easy to remove and reattach the simple interlocking sections.
- Size: 4655 x 350 x 170mm (x2).
- **Model No. PRK01**
- List Price £709.95

£569.95 Exc. VAT
£683.94 Inc. VAT



1500kg Portable Pivot Car Lift

1500kg



- Maximum Lift Height: 585mm.
- Compact and easy-to-use to raise a vehicle either manually or with an electric drill of 90Nm or more (do not use an impact wrench as this will damage the mechanism).
- While raising, the lift can be stopped at any height before locking the vehicle level.
- Once raised it can be tilted forwards or backwards to allow much greater access to underside of car (always use suitably rated axle stands before getting under a vehicle).
- Three adjustable width settings (775/1130/1530mm) allows narrow chassis cars to be lifted, such as MGs and other small classic cars.
- Even with modern wider cars, this style of lift allows easy-access to sills and edges of vehicle that some lifts would obscure.
- **Model No. PPL01**
- List Price £739.95

£579.95 Exc. VAT
£695.94 Inc. VAT



This item is heavy. Extra assistance must be provided at the delivery point to help safe delivery.

3 Tonne Car Lift/Ramp

3 Tonne

- Compact, convenient and innovative 3 Tonne (pair) rated car ramps (maximum single axle weight of 1800kg), supplied with four stands and removable lifting beam, capable of raising a vehicle completely off the ground giving a clear workspace between vehicle and floor.
- Designed so the track width can be adjusted to fit various makes and model of cars with maximum tyre width of 380mm.
- Excellent for general servicing, exhaust work repairing damaged jacking points, sills, floor panels and undersealing.
- Will fit within confined areas such as garages and workshops.
- Safe and efficient operation, gives a clear workspace between the raised vehicle and floor.
- Requires a jack with a maximum saddle height of 100mm and maximum jacking height of 435mm to lift its jacking beam to a position where its stands can be inserted.
- Maximum jack pad diameter of Ø120mm.
- **Model No. MR1**
- List Price £1,599.95



MR1 CAR LIFT RAMP



MR1® Dimensions

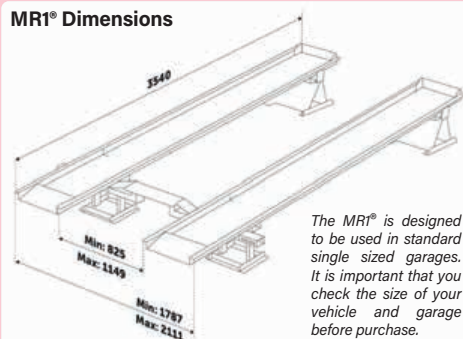

The MR1® is designed to be used in standard single sized garages. It is important that you check the size of your vehicle and garage before purchase.



This item is heavy. Extra assistance must be provided at the delivery point to help safe delivery.



£1,299.95 Exc. VAT
£1,559.94 Inc. VAT

Engine Stands

- 350kg Capacity**
- 450kg Capacity**
- 550kg Capacity**
- OR
- 900kg Capacity**



- Accepts wide variety of engines and transmissions.
- Head swivels through 360°.
- Swivel castors.
- Fully adjustable mounting arms.
- Maximum Load Length: 700mm.

Model No.	Capacity	List Price	Exc. VAT	Inc. VAT
ES350	350kg	£124.95	£104.95	£125.94
ES450	450kg	£154.95	£129.95	£155.94
ES550	550kg	£184.95	£149.95	£179.94
ES900F	900kg	£309.95	£249.95	£299.94

680kg Folding 360° Rotating Engine Stand with Geared Handle Drive

NEW Product

680kg Capacity

- Accepts a wide variety of engines and transmissions.
- The geared handle drive allows for easy and accurate 360° rotation in order to access all parts of the engine.
- Mounting head has four fully adjustable arms with bolt holes to accommodate various load sizes.
- Fitted with screw lock to ensure load is secured.
- Swivel castors provide excellent manoeuvrability.
- Assembled with clevis pins and clips so the stand can be folded for storage.
- Size (W x D x H): 1080 x 895 x 890mm.
- Maximum Load Length: 700mm.
- **Model No. ES680D**
- List Price £499.95



Engine Support Beams

Model No. ES300

300kg Capacity

Model No. ES500

500kg Capacity

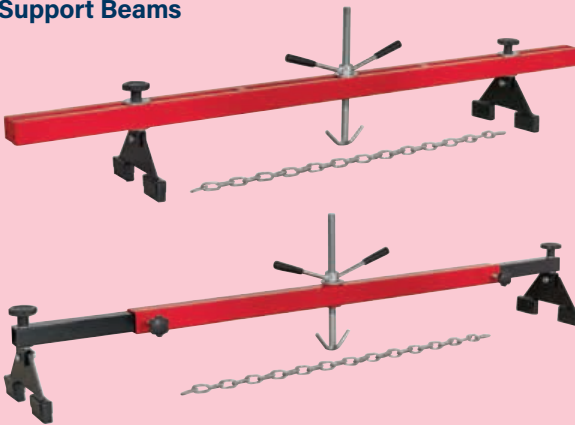

- Designed to support and accurately position engines during maintenance operations such as replacing anti-vibration mountings and certain body panels.
- Also used as an aid for the removal of gearboxes and transmissions.

Model No.	Capacity	Min./Max. Width	List Price	Exc. VAT	Inc. VAT
ES300	300kg	585/1580mm	£129.95	£109.95	£131.94
ES500	500kg	1120/1910mm	£149.95	£124.95	£149.94

10 Tonne Bench Type Hydraulic Press

10 Tonne

Hydraulic

Bench Mounting

- Table Aperture: 115mm.
- Working Table Width: 340mm.
- Ram Stroke: 180mm.
- Overall Height: 1060mm.
- High quality industrial press ideal for pressing, bending and extruding.
- Supplied with pressure gauge.
- Suitable for many automotive and industrial applications.
- **Model No. YK10B**
- List Price £309.95



£289.95 Exc. VAT
£347.94 Inc. VAT

Safety Guards for Presses

Aluminium

- Lightweight aluminium frames with tough steel mesh.
- Adjustable guards protect the user and/or passer by from being injured if workpiece is accidentally dislodged under load.
- Bolts onto either side of the table and features five height increments, allowing the workpiece to be placed onto table with no obstruction.
- One-way spring loaded locking clips then allow the guard to be pulled up quickly and snap straight into position for full protection.



Model No.	Applications	List Price	Exc. VAT	Inc. VAT
YKSG20	YK209F & YK20FFP	£89.95	£69.95	£83.94
YKSG30	YK30F, YK30FAH & YK30FFP	£99.95	£79.95	£95.94

Premier Heavy-Duty Floor Type Hydraulic Presses

Premier

5 YEAR GUARANTEE*

Floor Standing ← **Sliding Ram** → **HEAVY DUTY**

- Heavy-duty steel frame construction.
- Model No's YK209F and Model No. YK30F have hydraulic pump units.
- Model No. YK309FAH has a side mounted air motor powering hydraulic pump unit and foot pedal.
- Sliding hydraulic ram assembly.
- Frame head fitted with ram pressure gauge.
- Supplied with flat pressing plate/V-blocks.



Model No.	Capacity	Table Aperture	List Price	Exc. VAT	Inc. VAT
YK209F	20 Tonne	152mm	£849.95	£799.95	£959.94
YK30F	30 Tonne	164mm	£1,299.95	£1,199.95	£1,439.94
YK309FAH	30 Tonne	164mm	£1,419.95	£1,299.95	£1,559.94

12mm Reverse Action Spark Plug Thread Chaser



- Designed to repair damaged spark plug threads on modern engines.
- Unique design allows the tool to be passed through the plug thread into the combustion chamber, then expanded to the correct size starting on the inner, undamaged threads.
- Traditional thread restorers rely on luck for the restored and undamaged threads to align.
- Size/Length: 12/138mm.
- The first letter(s) of a Denso, NGK and Bosch plug code is the thread size identification and for Champion brand, it is the second letter(s) of plug code that is thread size identification.

£16.95 Exc. VAT
£20.34 Inc. VAT

- Model No. MS002
- List Price £22.95

Motorcycle Helmet Hook



- Wall and door mountable helmet hook suitable for all motorcycle helmets.
- Designed in order to keep your helmet safe and out of the way when not in use.

£7.45 Exc. VAT
£8.94 Inc. VAT

- Model No. MS0811
- List Price £9.95

Motorcycle Helmet and Jacket Hook



- Wall and door mountable helmet hook suitable for all motorcycle helmets.
- Designed in order to keep your helmet and jacket safe and out of the way when not in use.

£15.95 Exc. VAT
£19.14 Inc. VAT

- Model No. MS0812
- List Price £19.95

Motorcycle Transport Covers



- Heavy-duty covers are ideal for protecting a motorcycle when being transported on a trailer.
- Waterproof double-stitched and heat sealed seams ensure the motorcycle stays dry.
- Easy-to-use buckle system secures the cover to the bike in all weathers.
- Air vents provide airflow while being transported and ventilation while being stored.
- Elastic hem ensures a tight fit to the motorcycle.
- Supplied in a drawstring storage bag.

Model No.	Size (L x W x H)	List Price	Exc. VAT	Inc. VAT
MTCM	2440 x 1120 x 1120mm	£64.95	£49.95	£59.94
MTCL	2900 x 1120 x 1120mm	£69.95	£54.95	£65.94

Motorcycle Ground Anchor 4 Security Bolts



- Heavy-duty hardened steel bolt down anchor.
- Supplied with all fixings.
- Provides a secure locking point for items such as motorcycles, bicycles, boats, caravans and trailers.
- Contents: Anchor, Security Bolts, Ball-Bearings.



£12.95 Exc. VAT
£15.54 Inc. VAT

- Model No. MCGA01
- List Price £14.95

1L Motorcycle Portable Fuel Tank

1L

E10 Compatible



- Eliminates need to balance fuel tank in an awkward position.
- Simply remove your tank, connect the auxiliary fuel tank, which is gravity fed, and hang it up using the hook provided.
- Features 1L tank, 1500mm hose, hose clamps (x2), hose clips (x2), on/off Tap.
- For dual entry carburettor systems, use the Model No. MS029DCK Fuel Feed Lines.

£26.95 Exc. VAT
£32.34 Inc. VAT

Dual Carburettor Accessory Kit for MS029

- Model No. MS029DCK
- List Price £10.95



£6.95 Exc. VAT
£8.34 Inc. VAT

Brake Bleeder Set with Container



- Composite collection bottle with magnetic locating pad.
- Capacity: 100ml.
- Supplied with non-return valve, tubes and connectors.

£7.95 Exc. VAT
£9.54 Inc. VAT

- Model No. VS02011
- List Price £13.95

Magnetic

Freestanding Motorcycle Helmet & Gear Tidy

- Powder coated steel construction, for added corrosion resistance.
- Freestanding unit, designed to organise the storage of gloves, clothing, boots and helmet.
- Adjustable shelves allows for easy storage of up to four helmets.
- Strong construction, shelf capacity of 18kg and hanging rack capacity of 10kg.
- Large capacity, capable of storing two full sets of kit and more.

- Model No. MS081FS
- List Price £129.95

£99.95 Exc. VAT
£119.94 Inc. VAT

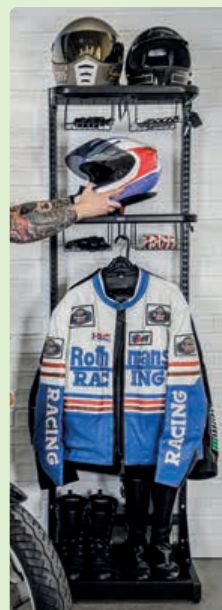

Motorcycle Covers

- Ideal for protection, rain or shine, against weathering and fading.
- Double layer cover for extra protection.
- Inner layer is made from soft anti-scratch material to protect motorcycle's paintwork.
- Has a clear PVC pocket to accept Model No. SPP01 Solar Panel (requires Model No. SPP01.A Adaptor) to enable battery charging while cover is fitted to the motorcycle without the need for mains power supply.
- Elastic corners with strap and buckle for easy and secure fitting.
- Eyelet enabling wheel lock to be fitted.



Model No. MCS



Supplied in a storage bag.

Model No.	Size (L x W x H)	List Price	Exc. VAT	Inc. VAT
MCS	Small 1830 x 890 x 1300mm	£27.45	£7.45	£8.94
MCM	Medium 2320 x 1000 x 1350mm	£28.95	£22.95	£27.54
MCL	Large 2460 x 1050 x 1370mm	£29.95	£24.95	£29.94

Motorcycle Chain Brush

- Composite angled chain brush.
- Suitable for use on all chain types.
- **Model No. VS1804**
- List Price £13.95



£9.95 Exc. VAT
£11.94 Inc. VAT

11pc Adjustable C-Spanner Hook & Pin Wrench Set

- Hardened and tempered drop-forged Chrome Vanadium steel.
- Specially designed for use with slotted retaining rings.
- Hook and pin interchangeable hinged arms with three wrenches covering sizes 19-121mm.
- Pin Sizes: Ø4-8mm.
- Supplied in tough storage case.
- **Model No. SMC2**
- List Price £79.95



£51.95 Exc. VAT
£62.34 Inc. VAT

Trike Covers



Model No. STC02



Model No. STC01



Supplied in a storage bag.

- Ideal for protection, rain or shine, against weathering and fading.
- Features a clear PVC pocket to accept Model No. SPP01 Solar Panel (requires Model No. SPP01.A Adaptor) to enable battery charging while cover is fitted to the vehicle without the need for mains power supply.
- Elastic corners with strap and buckle for easy and secure fitting.
- Made from Oxford 300D material.

Model No.	Size	Length	Bottom Width (Front/Rear)	Height (Front/Rear)	List Price	Exc. VAT	Inc. VAT
STC03	Small	2500mm	470/1550mm	1250/1400mm	£79.95	£59.95	£71.94
STC02	Medium	2750mm	470/1750mm	1300/1400mm	£84.95	£64.95	£77.94
STC01	Large	3700mm	450/2000mm	1300/1450mm	£89.95	£69.95	£83.94
STC01XL	X-Large	4500mm	450/2000mm	1400/1550mm	£95.95	£74.95	£89.94

9pc Motorcycle Wheel Bearing Removal Kit



- For easy removal of wheel bearings.
- Covers sizes from 10-25mm so will suit most popular motorcycles and ATV/quadbikes.
- Drift Shafts; 250, 400mm.
- Collets; Ø10, 12, 15, 17, 19, 20, 25mm.
- **Model No. MS062**
- List Price £69.95

£51.95 Exc. VAT
£62.34 Inc. VAT

Motorcycle Chain Maintenance Kit

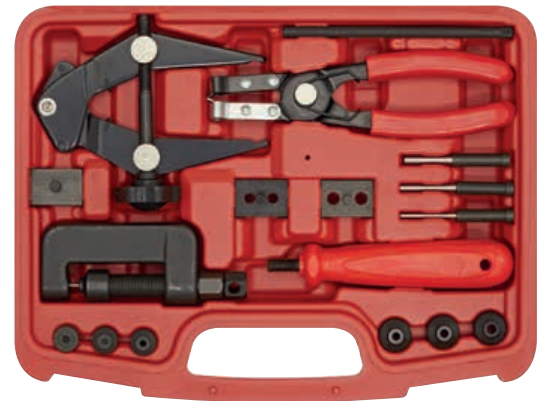

- Breaks and rejoins most types of chain quickly and easily.
- Suitable for most sizes of drive or cam chain from #25 to #520.
- Supplied with a range of pins, dies and detailed instructions.
- Chain link pulling tool is a useful third hand tool for pulling chain ends together while re-linking.
- **Model No. VS779KIT**
- List Price £74.95

£49.95 Exc. VAT
£59.94 Inc. VAT

14pc Motorcycle Brake Piston Removal Kit

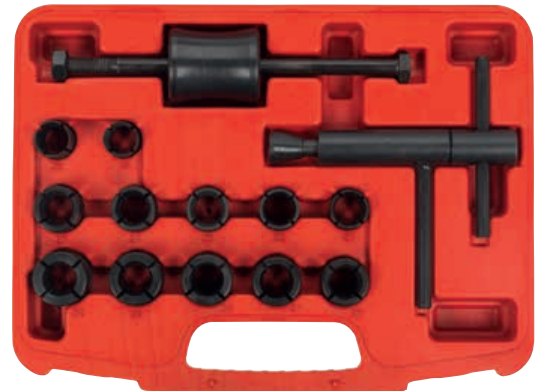

- Designed to reduce the time taken when removing piston from motorcycle brake calipers.
- Extract brake caliper pistons without risk of damage to outer face of piston.
- Includes 12 adaptors to suit different sized pistons.
- Detachable slide hammer for impact removal.
- Capacity: Ø19-30mm.
- **Model No. MS162**
- List Price £79.95

£56.95 Exc. VAT
£68.34 Inc. VAT

Motorcycle Handlebar Tie Down

700kg 35mm



- Manufactured from polyester webbing with stitched reinforcement around loops.
- Must be used in conjunction with suitable ratchet tie downs.
- Suitable for workshop use or for securing motorcycle to flat-bed or trailer.
- Simple cam buckle fastener tensions the webbing to provide superior load restraint.
- Breaking Strain: 700kg.
- **Model No. TDMCHB**
- List Price £14.95

£9.95 Exc. VAT
£11.94 Inc. VAT

Motorcycle Rear Wheel Tie Down

1000kg 35mm

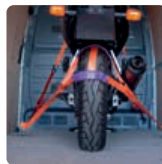
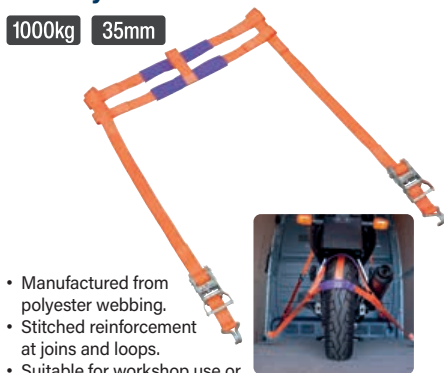

- Manufactured from polyester webbing.
- Stitched reinforcement at joins and loops.
- Suitable for workshop use or for securing motorcycle to flat-bed or trailer.
- Secures rear wheel to anchor point without compressing the suspension units, reducing the risk of seal damage.
- Ratchet mechanically tensions the webbing using a simple drum and ratchet mechanism for superior load restraint.
- Breaking Strain: 1000kg.
- **Model No. TDMCRW**
- List Price £24.95

£16.95 Exc. VAT
£20.34 Inc. VAT

Tie Down Securing Loop - Pair

2000kg 35mm 450mm Length

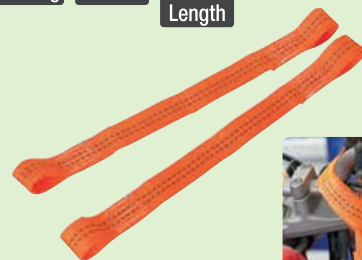

- Manufactured from polyester webbing.
- Use to either loop or create a slip knot at any appropriate point of the load and then attach to the hook of the strap.
- Suitable for use on motorcycles or offset loads to help prevent scratches to paint finishes and chrome.
- Breaking Strain: 2000kg.
- Webbing Length: 450mm.
- **Model No. TDLO1**
- List Price £5.45

£3.75 Exc. VAT
£4.50 Inc. VAT

Fast Lock Tie Down System for Motocross Bikes



- Securely holds your motocross bike on to a trailer or van, with the Fast Lock system, no ratchet straps or wheel chock required.
- Provided with mounting plates and quick release latches, allowing for fast installation and removal of the clamp.
- Each mounting plate has a D-ring creating additional anchor points to the trailer floor.
- **Model No. SPL01**
- List Price £99.95

£84.95 Exc. VAT
£101.94 Inc. VAT

Anti-Dive Fork Brace



- Device designed to stop the over-compression of motorcycle forks whilst in transit.
- For use on off-road style motorcycles with a minimum front wheel to mudguard clearance of 255mm.
- **Model No. SMC56**
- List Price £9.95

£5.95 Exc. VAT
£7.14 Inc. VAT

Fork Seal Driver Kit

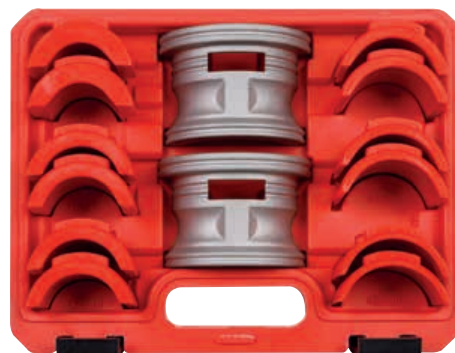

- Interchangeable insert system allows the seal driver to work perfectly on forks from Ø35-50mm.
- Contents: Seal Driver Inserts; Ø35-36, 40-41, 42-43, 45-46, 47-48, 49-50mm, Seal Driver Shell.
- Ergonomically designed driver body requires less power and aids accurate operation.
- **Model No. SMC49**
- List Price £99.95

£69.95 Exc. VAT
£83.94 Inc. VAT

10-Pocket Tool Roll



- Heavy-duty water-resistant canvas tool roll.
- Ideal for organising tools and taking them on the go.
- 10-Pockets of various sizes for an array of tools.
- Fitted with adjustable strap.
- **Model No. SMC45**
- List Price £10.95

£7.45 Exc. VAT
£8.94 Inc. VAT



6-Pocket Zipped Tool Pouch



- Heavy-duty reinforced zipped tool pouch perfect for taking essential tools on the go.
- Fitted with an array of storage solutions for any tool you may need.
- Contains six pockets for items such as spanners as well as seven adjustable hook-and-loop retainers, six elastic retainers and a metal clip for storing a tape measure.
- Supplied with convenient carry handle.
- **Model No. SMC43**
- List Price £15.95

£7.95 Exc. VAT
£9.54 Inc. VAT



454kg Hydraulic Motorcycle Lift

454kg

Hydraulic



- Min./Max. Height: 190/710mm.
- Table Size (W x L): 690 x 2200mm.
- All steel construction with heavy-duty, foot operated, integral hydraulic pump and ram assembly.
- Fitted with platform safety lock device to fix at two working heights of 710mm and 490mm and to prevent accidental lowering.
- Sliding panel platform and front wheel clamp assist removal of rear motorcycle wheel.
- Support platform fitted with full width loading ramp.
- Base assembly fitted with transport wheels and lock-downs to prevent lift moving during use.
- Suitable for use with centre-stand motorcycles or with paddock stand.
- **Model No. MC401**
- List Price £929.95



£799.95 Exc. VAT
£959.94 Inc. VAT



This item is heavy. Extra assistance must be provided at the delivery point to help safe delivery.

454kg Air/Hydraulic Motorcycle Lift

454kg

AIR Hydraulic



- Min./Max. Height: 190/710mm.
- Platform Width/Length: 690/2200mm.
- All steel construction with air pump or foot pedal for manual operation.
- Integral hydraulic pump and air motor assembly.
- Air Consumption: 706cfm.
- Fitted with platform safety lock device to fix platform at two working heights of 490 and 710mm to prevent accidental lowering.
- Front wheel clamp for stability and sliding panel for easy rear wheel removal.
- Support platform fitted with full width loading ramp.
- Base assembly fitted with transport wheels and lock-downs to prevent lift from moving during use.
- Suitable for use with centre-stand motorcycles or with paddock stand.
- **Model No. MC401A**
- List Price £1,029.95

Scan for our full range of **MOTORCYCLE LIFTS**



£899.95 Exc. VAT
£1,079.94 Inc. VAT



This item is heavy. Extra assistance must be provided at the delivery point to help safe delivery.

450kg Motorcycle Lift - 12V Electro/Hydraulic

450kg

ELECTRO Hydraulic

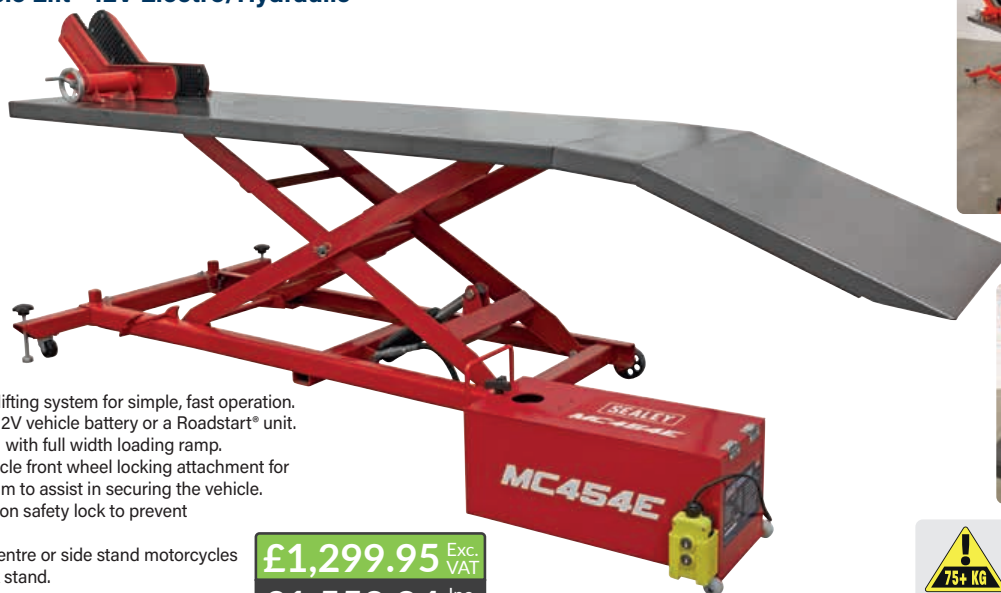

- All steel construction with a 454kg capacity.
- 12V Electro/Hydraulic lifting system for simple, fast operation.
- Can be powered by a 12V vehicle battery or a Roadstart® unit.
- Support platform fitted with full width loading ramp.
- Supplied with motorcycle front wheel locking attachment for tyre widths up to 135mm to assist in securing the vehicle.
- Fitted with multi-position safety lock to prevent accidental lowering.
- Suitable for use with centre or side stand motorcycles or with a rear paddock stand.
- **Model No. MC454E**
- List Price £1,499.95

£1,299.95 Exc. VAT
£1,559.94 Inc. VAT



This item is heavy. Extra assistance must be provided at the delivery point to help safe delivery.

Safety is paramount when working with high voltage EV systems. Specialist tools and training, equip technicians with the expertise to handle electric vehicles safely.

SEALEY continually strives to develop new and innovative tools and equipment designed to keep technicians safe whilst servicing these vehicles. The following products showcase our PPE and exclusion zone equipment, along with a selection of insulated VDE approved tools and high voltage testers.

Personal Protection Kit



- Ideal for technicians working on modern hybrid and electrical vehicles.

Model No. HP55K2COMBO Package includes:

- HRP45 - High Voltage Rescue Pole
- HVG1000VL - 1kV Electrician's Safety Gloves
- HVM17K02 - Electrician's Insulating Rubber Safety Mat

Model No.	Type	List Price	Exc. VAT	Inc. VAT
HRP45	High Voltage Rescue Pole	£176.95	£149.95	£179.94
HVG1000VL	1kV Electrician's Safety Gloves - Pair	£93.95	£79.95	£95.94
HVM17K02	Electrician's Insulating Rubber Safety Mat	£82.95	£69.95	£83.94
HP55K2COMBO	Personal Protection Kit	£334.95	£279.95	£335.94

Pneumatic Glove Tester



- Pneumatic glove tester used to carry out a pressure test on electrician's high voltage gloves.

- Suitable for use with Model No. HVG1000VL Gloves.

- **Model No. GT117**
- List Price £236.95

£209.95 Exc. VAT
£251.94 Inc. VAT

High Voltage Warning Signs



- Suitable for use on vehicles/exclusion zones.
- Model No. HVSA4 is a rigid 3mm thick plastic sign.
- Model No. HVS1 is printed on both sides and supplied with two suction cups on the base.

Model No.	Size (W x H)	List Price	Exc. VAT	Inc. VAT
HVSA4	200 x 300mm	£22.95	£14.95	£17.94
HVS1	210 x 300mm	£27.95	£17.95	£21.54

Insulated Tools VDE Approved



- Fully insulated to VDE and EN 60900 standards to protect from electric shocks up to 1500V DC and 1000V AC.
- Ideal for technicians working on modern hybrid and electrical vehicles (1500V DC safe live working).
- Also suitable for electricians and other trades (1000V AC safe live working).

Model No.	Type	List Price	Exc. VAT	Inc. VAT
AK8526	Scissors	£23.95	£17.95	£21.54
AK8632	Cable Knife	£15.95	£12.95	£15.54

CAT IV 1000V High Voltage Tester Hybrid/Electric Vehicles

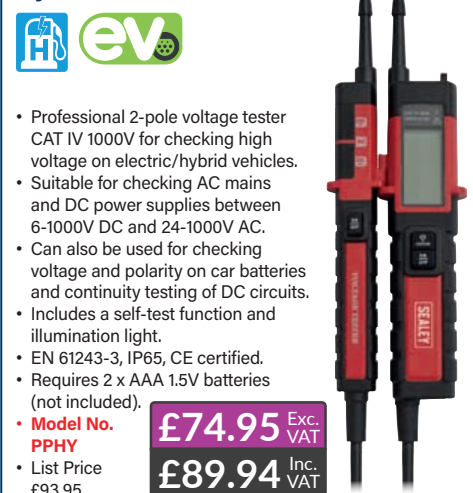

- Professional 2-pole voltage tester CAT IV 1000V for checking high voltage on electric/hybrid vehicles.
- Suitable for checking AC mains and DC power supplies between 6-1000V DC and 24-1000V AC.
- Can also be used for checking voltage and polarity on car batteries and continuity testing of DC circuits.
- Includes a self-test function and illumination light.
- EN 61243-3, IP65, CE certified.
- Requires 2 x AAA 1.5V batteries (not included).

- **Model No. PPHY**

- List Price £93.95

£74.95 Exc. VAT
£89.94 Inc. VAT

Hybrid/Electric Vehicle Warning Sign



- Essential safety warning sign for placing on a hybrid or electric vehicle whilst service or repair operations are being carried out.
- A4 300gsm paper with wipeable gloss finish.
- Includes a box for the technician's name, to clearly identify who is working on the vehicle.

- **Model No. HYBRIDSIGN**
- List Price £7.25

£4.95 Exc. VAT
£5.94 Inc. VAT

Hybrid/Electric Vehicle Keyring Warning Tag

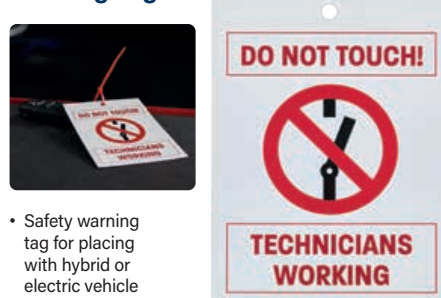

- Safety warning tag for placing with hybrid or electric vehicle keys whilst service or repair operations are being carried out.
- It is essential that the vehicle keys are kept secure and away from the vehicle during service or repair work.
- 80 x 110mm 400gsm paper with gloss finish.

- **Model No. HYBRIDTAG**
- List Price £4.45

£2.95 Exc. VAT
£3.54 Inc. VAT

Digital Automotive Analyser/Insulation Tester - Hybrid/Electric Vehicles



- Specially designed for hybrid vehicles and conforms to EN61010 CAT III (1000V) and CAT IV (600V).
- Unlike other multimeters this unit has an insulation test function that allows testing of the insulation of the high voltage cables and motor generator units found on hybrid vehicles.

- **Model No. TA320**
- List Price £414.95

£339.95 Exc. VAT
£407.94 Inc. VAT

3pc Pliers Set VDE Approved



- Induction-hardened cutting edges.
- Soft grip handles for comfort and control.
- Ideal for technicians working on modern hybrid and electrical vehicles.
- Cutting Capacities:
Ø1.8, Ø2, Ø2mm.
- **Model No. AK83452**
- List Price £69.95

£46.95 Exc. VAT
£56.34 Inc. VAT

Premier

LIFETIME
GUARANTEE

9pc 3/8" Sq Drive Insulated Socket Set VDE Approved

3/8"
Sq Drive
8-19mm



- Contents: Sockets; 8, 10, 12, 13, 14, 17, 19mm, Comfort Grip Ratchet Wrench with Push-Button Quick Release, 100mm Extension Bar.
- **Model No. AK7942**
- List Price £181.95

£114.95 Exc. VAT
£137.94 Inc. VAT

Premier

LIFETIME
GUARANTEE

13pc Interchangeable Screwdriver Set VDE Approved

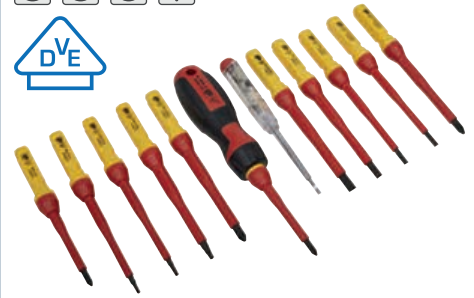

- Contents: Slotted; 3 x 100, 4 x 100, 5.5 x 100, 6.5 x 100mm, Phillips; #1 x 80, #2 x 100mm, Pozzi; #1 x 80, #2 x 100mm, TRX-Star*; T10 x 100, T15 x 100, T20 x 100mm, Mains Tester, Driver Handle.
- Insulated and VDE approved for use up to 1000V AC and 1500V DC.
- Supplied in storage case.
- **Model No. AK6128**
- List Price £40.95

£22.95 Exc. VAT
£27.54 Inc. VAT

Premier

LIFETIME
GUARANTEE

27pc Insulated Tool Kit - VDE Approved

3/8"
Sq Drive



- Manufactured from hardened and tempered Chrome Vanadium steel.
- Each tool is fully insulated to VDE and EN 60900 standards to protect from electric shocks up to 1500V DC and 1000V AC.
- Contents: 3/8" Sq Drive Sockets; 7, 8, 10, 12, 13, 14, 17, 22mm, 3/8" Sq Drive Reversible Ratchet, 3/8" Sq Drive 100mm Extension Bar, 3/8" Sq Drive T-Handle, Open-End Spanners; 7, 8, 10, 12, 13, 14, 17, 19mm, Screwdrivers; Slotted - 4 x 100, 5.5 x 125mm, Phillips - #1 x 100, #2 x 100mm, Pliers; 200mm Combination, 160mm Diagonal Side Cutters, Cable Knife.
- **Model No. AK7945**
- List Price £369.95

£249.95 Exc. VAT
£299.94 Inc. VAT



Premier

LIFETIME
GUARANTEE

Exclusion Zone Kit



Ideal for technicians working on modern hybrid and electrical vehicles.

Package includes:

- RWSBKIT - 25m Red/White Post & Chain Kit
- HVSA4 - 200 x 300mm High Voltage Warning Sign
- HYBRIDSIGN - Hybrid/Electric Vehicle Warning Sign (x2)
- HYBRIDTAG - Hybrid/Electric Vehicle Keyring Warning Tag
- **Model No. HP55KICOMBO**
- List Price £196.95

£139.95 Exc. VAT
£167.94 Inc. VAT

Hybrid Workshop Tool Kit

Independent garages are now seeing a marked increase in hybrid and electric vehicles being presented to them for service and repair work. With the rapid change in the design of vehicle powertrains in recent years, motor vehicle technicians are having to adapt to new technologies and working practices to be able to safely work on these types of vehicle.

- This kit contains a comprehensive range of tools and equipment that will be required to enable vehicle technicians to carry out work on these types of vehicle safely.

Package includes:

- RWSBKIT - 25m Red/White Post & Chain Kit
- HYBRIDTAG - Keyring Warning Tag
- HYBRIDSIGN - Warning Sign (x4)
- HVSA4 - 200 x 300mm High Voltage Warning Sign
- HRP45 - High Voltage Rescue Pole
- GT117 - Pneumatic Glove Tester
- HVG1000VL - 1kV Safety Gloves
- HVM17K02 - 1 x 1m Insulating Rubber Safety Mat
- AK7942 - 9pc 3/8" Sq Drive Insulated Socket Set - VDE
- AK6124 - 8pc Screwdriver Set - VDE Approved
- AK83452 - 3pc Pliers Set - VDE Approved
- AK63171 - 7pc Insulated Open-End Spanner Set VDE Approved
- TA320 - Digital Automotive Analyser/Insulation Tester
- **Model No. HP55KITCOMBO**
- List Price £1,549.95

£1,199.95 Exc. VAT
£1,439.94 Inc. VAT



19PC EV/HYBRID MASTER TOOL KIT

- Contents: APPD70, SF300R (x3), SF500R (x3), PPHY, BYSBKIT, HVG1000VL, HVM17K02, TA319, HVSA4, HYBRIDTAG, HYBRIDSIGN, AK83452, AK6124, AK63171, AK7940, STW803, AK7177, AK7178, HRP45.
- See www.sealey.co.uk for full specification.
- **Model No. HVCOM1**
- List Price £2,399.95

£1,799.95 Exc. VAT
£2,159.94 Inc. VAT



23PC EV/HYBRID MASTER TOOL KIT



- Contents: AP36MWS, SF500R, PPHY, BYSBKIT, HVG1000VL, HVM17K02, TA320, HVSA4, HYBRIDTAG, HYBRIDSIGN, TBTE08, TBTE09, TBTE04, AK7911, STW803, HRP45, TTS28, TBTE02, TBTE11, TBTE03, TBTE05, TBTE06, TBTE07.
- See www.sealey.co.uk for full specification.
- **Model No. HVCOM2**
- List Price £3,299.95



£2,799.95 Exc. VAT
£3,359.94 Inc. VAT

TIMING TOOL KIT FINDER

To simplify the process of timing tool identification, start using our FREE VRM lookup today. With over 150 timing tools in stock, and one of the most up-to-date ranges available on the market, make SEALEY lookup tool your first port of call.

If you can't find the details, or the answer you require from the Timing Tool Kit Finder, we have a fully trained technical sales team to provide additional assistance when required.

Tel: +44 (0)1284 757500 Email: technical@sealey.co.uk



Scan to explore our diverse range of Timing Tools.

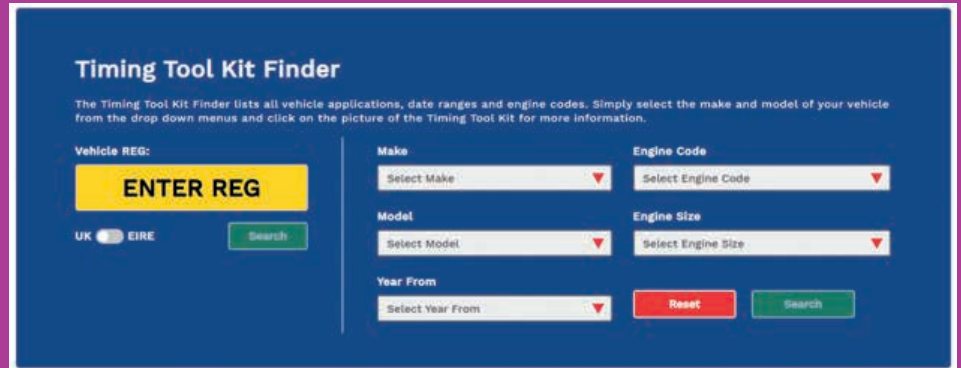

Universal Twin Camshaft Locking Tool



- Designed to lock twin camshaft in the timed position when replacing the timing belt.
- Huge range of application coverage from closely positioned sprockets on many twin cams to more widely spaced cam/injector pump sprockets on certain diesel engines.
- Features fine tooth adjustment and extension bar for increased applications.
- **Model No. VSE888**
- List Price £53.95



£44.95 Exc. VAT
£53.94 Inc. VAT

Petrol/Diesel Flywheel Locking Tool



- It is often necessary to remove the crankshaft pulley when replacing the timing belt.
- The pulley retaining bolt is fitted with a high torque loading and the flywheel must be securely locked during installation/removal.
- Jamming tools into the teeth of the flywheel will cause serious damage to both teeth and housing.
- This locking tool securely locates in the starter ring gear teeth and fixes to the housing using manufacturer's guidelines.
- Applications: Citroen, Fiat, FSO, LDV, Mercedes, Peugeot.
- **Model No. VSE2394**
- List Price £12.95

£11.45 Exc. VAT
£13.74 Inc. VAT

Petrol/Diesel Engine Flywheel Locking Tool Set for Ford - Belt Drive



- Associated tool for use in conjunction with a number of Ford timing tool kits for locking the crankshaft in timed position by locating into flywheel.
- Also suitable for counter-holding crankshaft when releasing or tightening crankshaft pulley bolts.
- Used on a wide range of Ford engines, particularly diesel 1.8TDdi/TDCi and 2.0TDCi, petrol 1.6Ti-VCT and later 1.25/1.4 16v Duratec.
- **Model No. VSE5945**
- List Price £34.95

£26.95 Exc. VAT
£32.34 Inc. VAT

12pc Crankshaft Pulley Removal Tool Set

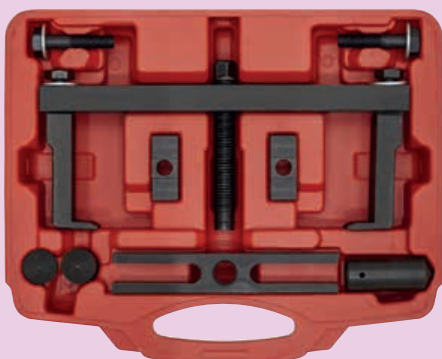

- Enables fast and simple removal of crankshaft and auxiliary pulleys.
- Chrome Molybdenum legs with thin jaws allow removal of pulleys with narrow tolerance between pulley and block.
- **Model No. PS997**
- List Price £99.95

£87.95 Exc. VAT
£105.54 Inc. VAT

550mm 1/2" Sq Drive Impact Bar



- Specially designed for use where nuts/bolts are not easily accessible for air impact tools, or air is not available.
- Ideal tool for loosening crankshaft pulley bolts.
- Simply fit the required impact socket, keeping the arm at a right angle to the shaft for maximum torque, and strike the top of the tool with a hammer to shock the nut or bolt loose.
- Features hand guard for extra safety.
- **Model No. VS786**
- List Price £52.95

£46.95 Exc. VAT
£56.34 Inc. VAT

Flywheel Turning Wrench



- Locates in starter ring gear teeth.
- Spring loaded catch for ease of use.
- **Model No. VS175**
- List Price £13.95

£9.95 Exc. VAT
£11.94 Inc. VAT

Ø8mm Camera Video Borescopes

Camera
Ø8mm



- High performance handheld borescopes with 60mm colour LCD screen and waterproof probe pod with IP67 rating.
- Features video record/playback and still images.
- Videos and images are stored on a micro SD card (not supplied).
- 2.5Ah Lithium battery capacity allowing up to 10 hours working time.
- Kit includes 45° mirror, hook and magnetic pick-up.
- USB Charging cable supplied.

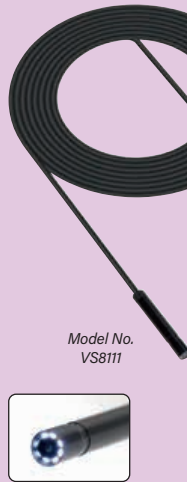

Model No.
VS8111



Model No.
VS8112



Model No.	Cable Length	List Price	Exc. VAT	Inc. VAT
VS8111	2m	£79.95	£64.95	£77.94
VS8112	10m	£99.95	£71.95	£86.34

Ø8mm Wi-Fi Borescope



Camera
Ø8mm



- Wi-Fi - App.
- Application: IOS, Android and Windows.
- Waterproof Level: IP67 (RIBU).
- Camera Head: Ø8mm.
- Camera Lens: 6 x LEDs.
- Resolutions: 640 x 480 pixels, 1280 x 720 pixels.
- Transmission Distance: 5-30m.
- Probe Length: 5m.
- Record and screen shot.
- Screen rotation function.
- Viewing Angle: 70°.
- Kit Includes charging cable, hook, magnet, and side mirror.
- **Model No. VS8113**
- List Price £44.95

£37.95 Exc. VAT
£45.54 Inc. VAT

Thermal Imaging Camera



Supplied in holster.



- Combines the function of surface temperature measurement and real-time thermal imaging.
- Features a traditional image camera to pinpoint test area with the ability to mix the thermal image over the top at varying intensities.
- Includes on-screen cursor to accurately locate temperature hotspots.
- Suitable for many industries including automotive, building and electrical.
- Screen Size: 52mm.
- Focal Distance: 50cm (Min. 20cm, Max. 1m).
- Field of Vision: 65°.
- Powered by 4 x AA batteries (supplied).
- **Model No. VS912**
- List Price £549.95

£419.95 Exc. VAT
£503.94 Inc. VAT

Ø95-178mm Oil Filter Pliers Commercial

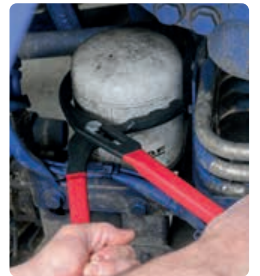
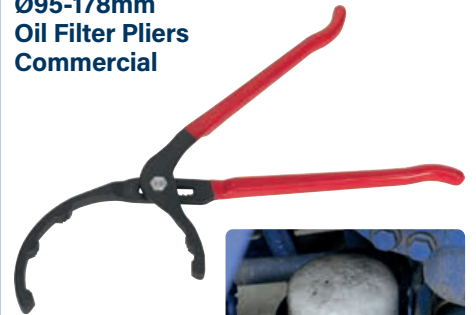

- Large forged pliers with chemically blackened finish.
- Serrated jaws and long handles for extra grip on oily filters.
- Features a ratchet joint adjustable head.
- Essential tool for removing commercial filters.
- Length: 520mm.
- **Model No. CV6412**
- List Price £61.95

£36.95 Exc. VAT
£44.34 Inc. VAT

Infrared Laser Digital Thermometer 12:1



LASER SIGHT



- High resolution laser thermometer that detects energy emission in the infrared spectrum and converts reading into a display of temperature.
- Features laser pointer, min./max., average/difference readings, data storage and data-hold function, high/low alarm setup, auto-power-off.
- Temperature is displayed on a large 29mm LCD panel with back-lit display for use in low light areas.
- Temperature can be shown in either °C or °F.
- Temperature Range: -50°C to +700°C (-58°F to +1292°F).
- Powered by 9V battery (supplied).
- Storage case included.
- **Model No. VS907**
- List Price £101.95

£74.95 Exc. VAT
£89.94 Inc. VAT

Infrared Laser Digital Thermometer 12:1



LASER SIGHT



- Detects energy emission in the infrared spectrum and converts reading into a display of temperature.
- Features laser pointer, data-hold and auto-power-off.
- Temperature is displayed on a large 23mm LCD HD colour screen with back-lit display for use in low light areas.
- Temperature can be shown in either °C or °F.
- Temperature Range: -50°C to +530°C (-58°F to +986°F).
- Powered by 2 x AAA batteries (not included).
- **Model No. VS904**
- List Price £51.95

£39.95 Exc. VAT
£47.94 Inc. VAT

2pc Strap Wrench Set



- Suitable for removing and installing oil filters as well as many other applications.
- Features soft grip handle for added comfort.
- Capacity: Ø120, Ø150mm.
- **Model No. AK6408**
- List Price £24.95

£11.95 Exc. VAT
£14.34 Inc. VAT



Video Borescopes



Camera
Ø9mm

Model No.
VS8230

Camera
Ø5.5mm

Model No.
VS8231

Camera
Ø3.9mm

Model No.
VS8232

A range of three high performance pistol grip borescopes with 85mm colour TFT screen, waterproof probe pod with IP67 rating. Each having the same main unit, but with a choice of camera probe diameters (Ø3.9mm, 5.5mm or 9mm).

Ø3.9mm Camera is small enough to fit into a diesel combustion chamber through the glow plug hole.

Ø5.5mm Camera gives extremely crisp image quality.

Ø9mm Camera is ideal if restricted access isn't an issue, is competitively priced, with crisp image quality.

All units feature video record/playback, still images and stream live video via the AV out connection. Videos and images are stored on a 4GB micro SD card (supplied) allowing up to 4.5 hours of video and 10,000 images, which can be transferred to a PC via the USB connection. Also features digital zoom control and rotate/flip control of image. Powered by lithium-ion battery pack giving up to 4 hours continuous use. AV and USB cables supplied.

Model No.	Camera	Pod Length	Viewing Angle	List Price	Exc. VAT	Inc. VAT
VS8230	Ø9mm	50mm	53°	£269.95	£199.95	£239.94
VS8231	Ø5.5mm	30mm	60°	£359.95	£249.95	£299.94
VS8232	Ø3.9mm	20mm	80°	£369.95	£279.95	£335.94

Pneumatic Diesel Injector Puller



Pneumatic

NEW
Product



- Fits most passenger and light commercial diesel injectors including Delphi, Denso, and Siemens.
- Uses vibration and pneumatic force to easily remove seized injectors.
- Set includes a pneumatic diesel injector puller, adaptors, air hose and a control valve with a 1/4" BSP connector.
- Maximum air supply 116psi(8bar).
- **Model No. VS2080**
- List Price £299.95

£249.95 Exc. VAT
£299.94 Inc. VAT

Flexible/Mouldable Funnel

NEW
Product

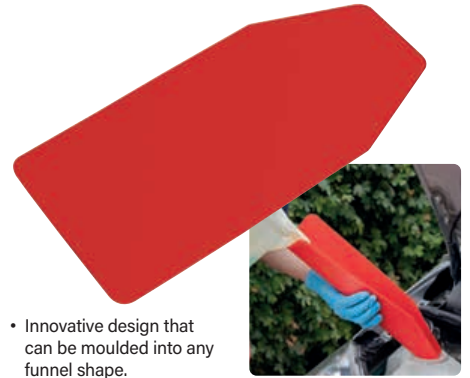

- Innovative design that can be moulded into any funnel shape.
- Quality vinyl with a flexible aluminium core.
- Wipe clean surface suitable for petrol, diesel, oil, brake fluid, anti-freeze and screen wash.
- Can be stored flat or rolled up, ideal for compact drawer or glove box storage.
- Dimensions 370 x 170 x 3mm.
- **Model No. VS5058**
- List Price £11.95

£9.95 Exc. VAT
£11.94 Inc. VAT

Injector Seal Removal Tool



- Designed to remove the copper injector seal when it has stuck into the head.
- Adjusts to allow seals with Ø6.7-8.7mm internal diameter to be removed.
- Simply drop the tool into the hole left by the injector, tighten the handle and lift out the seal.
- **Model No. VS2054**
- List Price £39.95

£29.95 Exc. VAT
£35.94 Inc. VAT

6-24V Circuit Tester

6V to 24V



- Suitable for 6-24V DC circuits.
- Insulated body with test light.
- Probe tip is covered with protective plastic cap.
- Tester illuminates when voltage is present.
- Supplied with cable and alligator earth clip.
- **Model No. AK5000**
- List Price £9.95

£4.95 Exc. VAT
£5.94 Inc. VAT

6-24V Circuit Tester

6V to 24V



- Suitable for 6-24V DC circuits.
- Knurled brass body with test light.
- Probe tip is covered with protective brass screw cap.
- Tester illuminates when voltage is present.
- Supplied with cable and alligator earth clip.
- **Model No. AK4008**
- List Price £13.45

£8.95 Exc. VAT
£10.74 Inc. VAT

6/12/24V Circuit Tester with Test Light

6V
12V
24V



- Suitable for testing 6, 12 and 24V DC circuitry.
- Insulated, pointed probe tests through wire insulation.
- Supplied with 1.5m cable and crocodile earth clamp.
- **Model No. AK402**
- List Price £18.95

£12.95 Exc. VAT
£15.54 Inc. VAT

6/12/24V Circuit Tester with Polarity Test

6V
12V
24V



- Continuity and polarity tester for 6, 12 and 24V systems.
- Polarity indicated by red/green LEDs respectively.
- Supplied with 1.5m cable and shrouded earth clip.
- **Model No. AK4030**
- List Price £24.95

£16.95 Exc. VAT
£20.34 Inc. VAT

15-Function Digital Automotive Multimeter with Bar Graph/PC Link



- Integrated circuit.
- High-visibility, back lit, LCD display with bar graph.
- PC interface.
- 15-Functions including pulse-width measurement for fuel injectors, idle air control motors and electronic transmission control systems.
- Auto-ranging and auto-power-off.
- Suitable for AC and DC circuits.
- **Model No. TA203**
- List Price £189.95

£149.95 Exc. VAT
£179.94 Inc. VAT

6-24V Auto Probe Plus

6V to 24V



- A brilliant tool for the auto electrician and mechanic.
- Just some of the tests on systems from 6V up to 24V which can be done quickly and efficiently:
 - Cooling fan motors
 - Fuel pumps
 - Window/Sunroof motors
 - Relays and lamps
 - Wiper motors
- Bench test electric components before installation.
- Integral worklight to aid use in dark engine bays plus an audible circuit tester for when the LED on the probe cannot be seen.
- Supplied with 4.8m cable for easy-access right around the vehicle.
- **Model No. PPX**
- List Price £43.95

£29.95 Exc. VAT
£35.94 Inc. VAT

0-30V Power Scope Automotive Probe

0V to 30V



- Features an audible continuity and positive/negative voltage indicator.
- Two integral worklights.
- 6m Lead connects to the battery supply and reaches to all areas of the vehicle.
- Includes a vehicle accessory socket adaptor and 6m extension cable.
- Supplied in storage case.
- **Model No. PP100**
- List Price £176.95

£124.95 Exc. VAT
£149.94 Inc. VAT

Pocket Multimeter



- Handy compact unit, small enough to fit in your pocket, making it ideal for basic circuit testing whilst on the move.
- Features flip lid for added screen protection and storage of leads.
- Conforms to EN 61010-1 CAT II safety requirements.
- Supplied with test leads.
- Measures:
 - AC and DC Voltage
 - DC Current
 - Resistance
 - Audible Continuity
- **Model No. MM18**
- List Price £21.95

£14.95 Exc. VAT
£17.94 Inc. VAT

8-Function Digital Multimeters with Thermocouple



Model No. MM20HV

- Heavy-duty general-purpose multimeters with clear and easy-to-read LCD display.
- Both features data-hold function, temperature probe and diode test facility.
- Housed in rugged rubber boot with integral stand.
- Measures: AC and DC Voltage, DC Current, Resistance, Temperature, Audible Continuity, Diode/Transistor Verification Mode.

Model No.	Colour	List Price	Exc. VAT	Inc. VAT
MM20	Red	£28.95	£19.95	£23.94
MM20HV	Green	£28.95	£19.95	£23.94

EOBD Code Reader

NEW Product



- Competitively priced EOBD code reader.
- OBDII/EOBD compliant vehicles Petrol 2001 and Diesel 2004 onwards.
- CAN enabled retrieves generic P0, P2, P3 and U10 codes and picks up manufacturer specific P1, P3 and U1 codes.
- This easy-to-use tool will then turn off the MIL light, clear codes and reset monitors.
- Supplied with comprehensive instructions.
- **Model No. VS8811**
- List Price £24.95

£19.95 Exc. VAT
£23.94 Inc. VAT

EOBD Code Reader Oil & Service Reset Tool



- Combines an EOBD code reader and oil service tool in one unit.
- Includes all the usual features expected in a quality EOBD code reader.
- Updateable via web-based downloads.
- Supplied with operating instructions, CD and USB cable in storage pouch.
- Visit www.auteltech.com and register, download instruction or contact technical sales for concise model applications.
- **Model No. OLS301**
- List Price £279.95



£224.95 Exc. VAT
£269.94 Inc. VAT

6-Function Professional Auto-Ranging Digital Clamp Meter NCVD



- High precision clamp meter.
- Conforms to EN 61010-1 CATIII 600V safety requirements for electrical equipment for measurement, control and laboratory use.
- Features non-contact AC voltage detection function while controls are laid out to enable use with one-hand.
- Includes data and maximum hold functions.
- Double moulded housing with soft grip case and large display for ease of use.
- Supplied in zipped pouch with carry strap.
- **Model No. TM105**
- List Price £87.95

£54.95 Exc. VAT
£65.94 Inc. VAT

12V Fuel Injector Tester - Petrol

12V



- Operates injectors individually to diagnose fuel delivery problems on petrol vehicles with electronic fuel injection.
- Works with engine off and pulse timer may be used with fuel pressure gauge.
- Powered by vehicle's 12V battery.
- Can be used to locate fuel system faults such as:
 - Clogged or leaking fuel injectors
 - Sluggish or sticky fuel injectors
 - Wiring harness faults
- **Model No. VS211**
- List Price £59.95

£39.95 Exc. VAT
£47.94 Inc. VAT

Multi Voltage Glow Plug Tester



- Designed to test low voltage glow plug operation on modern diesel engines.
- Prevents glow plug damage caused by testing with the vehicle battery.
- Glow plugs can be tested whilst in situ.
- Supplied in storage case with instructions.
- Requires 9V battery (not included).
- **Model No. VS270**
- List Price £89.95

£59.95 Exc. VAT
£71.94 Inc. VAT

92pc Test Lead Set

- Comprehensive set of test leads and components suitable for testing, isolating and evaluating automotive electronic circuits.
- Includes standard Ø4mm banana style plugs and sockets suitable for use with most diagnostic multimeters and test equipment.
- Supplied in sectioned storage case for quick location of components.

• **Model No. TA111**
• List Price £299.95

£209.95 Exc. VAT
£251.94 Inc. VAT



15pc Test Lead Set



- Professional set of test leads and components suitable for testing and evaluating automotive electronic circuits on modern vehicles.
- Features 0.7mm back probes ideal for testing vehicle sensors and dual colour LEDs for directional polarity testing.
- Set includes standard Ø4mm banana style plugs and sockets suitable for use with most diagnostic multimeters and test equipment.

• **Model No. TA112**
• List Price £116.95

£89.95 Exc. VAT
£107.94 Inc. VAT

6pc Automotive Test Lead & Crocodile Clip Set



- Set of 1.35m automotive test leads with Ø4mm banana style connectors.
- Used for testing and diagnosing faults in electronic circuits.
- Suitable for use with most multimeters and analysers.

• **Model No. TATL**
• List Price £32.95

£24.95 Exc. VAT
£29.94 Inc. VAT

Digital Tachometer Contact/Non-Contact



- Professional quality laser instrument for fast and accurate measurement of rotational speed with or without contact.
- Also measures total revolutions, frequency, surface speed and distance.
- 10 Selectable data set memories.
- Supplied with reflective tape, for non-contact measurement, and three heads for contact measurement.
- Powered by 9V battery (supplied) or 6V DC auxiliary transformer (not included).

• **Model No. TA050**
• List Price £124.95

£99.95 Exc. VAT
£119.94 Inc. VAT

Lambda Sensor Tester/Simulator



- Tests Zirconia and Titania lambda sensors and ECU.
- Suitable for 1, 2, 3 and 4 wire sensors, heated and unheated.
- LED display shows crossover signal from sensor.
- Simulates rich or lean mixture signals to check ECU response.
- Insulation-piercing clip for quick and easy connection plus display to confirm wire identity.
- Features a low battery indicator and powered by 9V battery (supplied).

• **Model No. VS925**
• List Price £107.45

£79.95 Exc. VAT
£95.94 Inc. VAT

2pc Injector Bore Cleaning Brush Set



- Ideal for cleaning and decarbonising areas with limited access, especially injector apertures before refitting.
- Brush Sizes: Ø10-34.5mm, Ø15mm.
- Brush Type: Steel.
- Overall Length: 260mm, 275mm.

• **Model No. VS1920**
• List Price £20.95

£12.95 Exc. VAT
£15.54 Inc. VAT

35 Blade Feeler Gauge Dual Marked



- Imperial graduated 35 blade feeler gauge.
- Sizes: 0.0015" to 0.035".
- Dual marked in Imperial and Metric.
- Blade dimensions 75 x 13mm.

• **Model No. VS512**
• List Price £16.95

£10.95 Exc. VAT
£13.14 Inc. VAT

Nitrogen Oxide Sensor Port Thread Chaser M22 x 1.5mm

- Manufactured from Chrome Vanadium steel with black phosphate finish.
- Suitable for cleaning and repairing damaged threads on the sensor port, prior to new sensor being fitted.
- Thread Size: M22 x 1.5mm.
- Use with 22mm socket or spanner.

• **Model No. VS536**
• List Price £8.95

£6.95 Exc. VAT
£8.34 Inc. VAT

Fuel Vaporiser Port Thread Chaser for Ford M20 x 1.5mm

- Manufactured from Chrome Vanadium steel with black phosphate finish.
- Suitable for cleaning and reforming threads on exhaust system fuel vaporiser ports.
- Short lead-in on thread allows thread to be cut as close as possible to internal seat of the exhaust.
- Thread Size: M20 x 1.5mm.
- Use with 21mm socket or spanner.

• **Model No. VS537**
• List Price £9.95

£7.95 Exc. VAT
£9.54 Inc. VAT

2000W Induction Heater



- Mobile induction heater for fast heat delivery.
- Install appropriate coil and place over or around ferrous metal.
- Ideal for loosening stubborn and seized fixings.
- Supplied with special dent induction block for panel expansion and induction pad for plastic trim/sticker removal.
- Induction element delivers high heat fast and effectively.
- Contents: Direct Coil; Ø20, Ø30mm, Side Coil; Ø20, Ø30mm, Pad Coil; Ø55mm, Flex Coil; 920mm, Induction Block - 50 x 35 x 30mm.
- Supplied in storage case.
- **Model No. VS230**
- List Price £899.95

2000W



Ø29mm Induction Adaptor



- Induction adaptor for Model No's. VS230 and VS250 Induction Heaters.
- **Model No. VS23111**
- List Price £39.95

£32.95 Exc. VAT
£39.54 Inc. VAT

ATF Adaptor VAG 7-Speed DSG Gearbox

VAG



- For use on VAG vehicles fitted with 7-speed DSG gearboxes.
- OEM equivalent tool VAS6617/12.
- Designed to work with Sealey VS7009 gear oil dispensing tool.
- **Model No. VS70097**
- List Price £24.95

£18.95 Exc. VAT
£22.74 Inc. VAT

£669.95 Exc. VAT
£803.94 Inc. VAT

Induction Coils



Ref.	Model No.	Description	Suitability	List Price	Exc. VAT	Inc. VAT
A	VS2301	Ø15mm Induction Coil - Direct	VS230, VS240, VS250, VS260	£17.95	£14.95	£17.94
B	VS2302	Ø15mm Induction Coil - Side	VS230, VS240, VS250, VS260	£17.95	£14.95	£17.94
C	VS2303	Ø20mm Induction Coil - Direct	VS230, VS240, VS250, VS260	£17.95	£14.95	£17.94
D	VS2304	Ø20mm Induction Coil - Side	VS230, VS240, VS250, VS260	£17.95	£14.95	£17.94
E	VS2305	Ø28mm Induction Coil - Direct	VS230, VS250, VS260	£17.95	£14.95	£17.94
F	VS2306	Ø28mm Induction Coil - Side	VS230, VS250, VS260	£17.95	£14.95	£17.94
G	VS2307	Ø32mm Induction Coil - Direct	VS230, VS250, VS260	£17.95	£14.95	£17.94
H	VS2308	Ø32mm Induction Coil - Side	VS230, VS250, VS260	£17.95	£14.95	£17.94
I	VS2309	Ø55mm Induction Coil - Pad	VS230, VS240, VS250, VS260	£17.95	£14.95	£17.94
J	VS2310	920mm Induction Coil - Flexible	VS230, VS250, VS260	£17.95	£14.95	£17.94

3L Transmission Oil Filling System

3L

- Pump operated oil dispensing unit with a 3L capacity.
- Supplied with five multipurpose and three vehicle specific automatic transmission fluid adaptors.
- Features a fluid control and depressurising valve.
- Hose Length: 1.5m.
- **Model No. VS70095**
- List Price £159.95



£99.95 Exc. VAT
£119.94 Inc. VAT

Interchangeable Remote Action Hose Clamp Pliers



- Long reach tool designed for awkwardly positioned tag-type hose clips.
- Flexible cable and compact head help operation in confined spaces.
- Three interchangeable heads.
- One cable for standard hose clamp 670mm long and 3-52mm opening.
- One cable for Clic-R® Type clamp 635mm long and 0-24mm opening.
- One cable for dual-sided clamp for spring type and truck hose clamp, 670mm long and 0-75mm opening.
- **Model No. VS1675**
- List Price £103.95

£79.95 Exc. VAT
£95.94 Inc. VAT

Commercial Vehicle Height Indicators



• Fully adjustable height indicators for commercial vehicle cabs.

Model No.	Type	Range	List Price	Exc. VAT	Inc. VAT
CV032	Imperial	8-20ft	£15.95	£10.95	£13.14
CV032M	Metric	2-6.75m	£15.95	£10.95	£13.14

Washer Jet Tool



- Compact, double end tool with pocket-clip.
- Screwed caps house a pointed scribe for cleaning and clearing washer jets at one end and finer probe for adjusting position of jets at the other.
- Heavily knurled body for sure handling.
- Overall Length: 104mm.
- **Model No. AK52206**
- List Price £11.45

£7.45 Exc. VAT
£8.94 Inc. VAT

40mm Premium EVA Kneeling Mat

40mm



- Premium 40mm shock absorbing EVA kneeling mat.
- Neoprene wipe clean material.
- Suitable for workshop, home and garden.
- Cut-out handle.
- Size (L x W x D): 470 x 280 x 40mm.
- **Model No. VS8595**
- List Price £19.95

£14.95 Exc. VAT
£17.94 Inc. VAT

Folding Mechanic's Kneeling Mats



Model No. VS8581

Model No. VS8582

Model No. VS8583

- Flexible kneeling mats.
- EVA foam padding for added comfort and hard wearing.
- Ideal for working on cold garage floors and for roadside repairs.



Model No. VS8582



Model No. VS8583

Model No.	Open Size (L x W x D)	Folded Size (L x W x D)	List Price	Exc. VAT	Inc. VAT
VS8581	500 x 230 x 23mm	250 x 230 x 46mm	£14.95	£11.95	£14.34
VS8582	1200 x 455 x 23mm	200 x 455 x 136mm	£44.95	£29.95	£35.94
VS8583	1200 x 565 x 31mm	200 x 565 x 174mm	£74.95	£59.95	£71.94

28mm EVA Mechanic's Kneeling Mat

28mm



- Oil and water-resistant.
- Suitable for use on workshop floor when working on wheels, brakes, tyres and exhausts.
- Also ideal for roadside repairs.
- Size (L x W x D): 450 x 215 x 28mm.
- **Model No. VS8573**
- List Price £14.45

£8.95 Exc. VAT
£10.74 Inc. VAT

28mm EVA Mechanic's Mat Set

28mm



- Oil and water-resistant.
- Set comprises full length and kneeler mats.
- For use on workshop floors when working on wheels, brakes, tyres and exhausts.
- Also ideal for roadside repairs.
- Sizes (L x W x D):
Kneeler; 450 x 215 x 28mm,
Full-length; 980 x 380 x 28mm.
- **Model No. VS8571**
- List Price £50.95

£27.95 Exc. VAT
£33.54 Inc. VAT

35mm Folding Mechanic's Mat with Headrest

35mm



- Can be used folded for kneeling or unfolded for under vehicle work.
- Ideal for working on cold garage floors or for roadside repairs.
- Folds away neatly with hook-and-loop straps when not in use.
- Folded Size (L x W x D): 660 x 444 x 70mm.
- Open Size (L x W x D): 1220 x 444 x 35mm.
- **Model No. VS860**
- List Price £65.95

£44.95 Exc. VAT
£53.94 Inc. VAT

3pc Mini Trim Panel Removal Set



- Ideal for removing interior trim, vents and battery replacement on key fobs.
- Slim profile and manufactured from resilient nylon to minimize panel damage and marking.
- **Model No. RT014**
- List Price £10.95

£7.95 Exc. VAT
£9.54 Inc. VAT

Trim Clip Tools

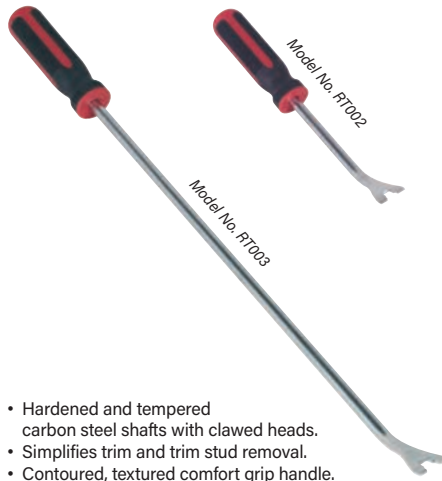

- Hardened and tempered carbon steel shafts with clawed heads.
- Simplifies trim and trim stud removal.
- Contoured, textured comfort grip handle.

Model No.	Length	List Price	Exc. VAT	Inc. VAT
RT002	250mm	£11.95	£8.45	£10.14
RT003	510mm	£16.95	£11.95	£14.34

Door Trim Clip Tool



- Suitable for the removal of door trim clips on most vehicles.
- Features coated U-profile tip to reduce the risk of damage to surrounding trim and contoured textured handle.
- **Model No. RT007**
- List Price £14.95

£10.95 Exc. VAT
£13.14 Inc. VAT

Carbon Steel Trim Tools

Premier

LIFETIME GUARANTEE

NEW Products



- Trim tools used for removing exterior and interior trim, mouldings, dashboards, door panels, and clips.
- Made from carbon steel S45C which is superior to plastic pry tools.
- Heat-treated HRC 38-42 for added strength.
- Chrome-plated.
- Perfect for precision work in any field, from automotive, fabrication, machining, construction, aviation and home use.

Model No.	Type	List Price	Exc. VAT	Inc. VAT
RT03	Wide/Curved Ends	£18.95	£14.95	£17.94
RT04	Small/Large Ends	£17.95	£13.95	£16.74

6pc Trim Clip Tool Set



- Designed for the removal of trim clips found on most vehicles.
- Comprises long and short reach steel shafts with clawed heads.
- Contoured and textured comfort grip handles.
- **Model No. RT06**
- List Price £34.95

£27.95 Exc. VAT
£33.54 Inc. VAT

4pc Trim Clip Set



- Tools designed to simplify the removal of vehicle trims.
- Set contains door trim tools with U and V profile tips, angled trim tool for use in confined spaces and window winder clip removal/installation tool.
- **Model No. TR010**
- List Price £17.95

£13.95 Exc. VAT
£16.74 Inc. VAT

Non-Slip Wing Cover



- Fits over car wing to protect against marking and scratching of the paint finish.
- Manufactured from water-resistant nylon with a non-slip foam lining.
- Resistant to water, oil and grease.
- Size (W x H): 800 x 450mm.
- **Model No. VS8501**
- List Price £24.95

£14.95 Exc. VAT
£17.94 Inc. VAT

Magnetic Workshop Wing Cover

Magnetic

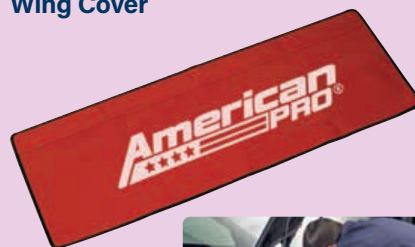

- Soft-faced vinyl material prevents scratching and marking of paintwork during servicing.
- Held in place by integral magnets.
- Size (W x H): 1070 x 400mm.
- **Model No. VS855**
- List Price £50.95

£34.95 Exc. VAT
£41.94 Inc. VAT

Magnetic Workshop Wing Cover with 4 Pockets

Magnetic



- Soft-faced vinyl material prevents scratching and marking of paintwork during servicing.
- Wing cover held in place by integral magnets.
- Four pockets for holding tools while working on car.
- Nominal Size: 1065 x 600mm.
- **Model No. VS856**
- List Price £64.95

£44.95 Exc. VAT
£53.94 Inc. VAT

1.2L Pneumatic Vacuum Brake & Clutch Bleeder

1.2L Capacity

Premier

2 YEAR GUARANTEE

- With a flexible hanging hook.
- Durable hard-wearing Acetal plastic.
- Trigger for adjusting air pressure, with an added trigger lock.
- Draws fluid from the bleeding nipple enabling either bleeding or full replacement of fluid in the system.
- Clear PVC hose easily checks for air bubbles. Hose length 1.5m.
- Does not require specialised brake reservoir caps.
- **Model No. VS0220**
- List Price £89.95



£64.95 Exc. VAT
£77.94 Inc. VAT

2.5L Brake & Clutch Bleeding System

2.5L Capacity

- One-person brake and clutch bleeding the professional way. Bleeding requires no external power source - simply fill and pump.
- Reservoir holds 2.5L of hydraulic fluid - flush the entire system with one fill, without the risk of running the reservoir dry.
- Pressure range makes unit suitable for use with ABS systems.
- Fitted with Ø45mm cap with 90° angled connector which is suitable for most European models.
- For alternative Brake & Clutch Bleeder Caps, order Model No's VS820SA, VS820UA, VS0204B, VS0204T, VS0204C4 and VS0204C.
- **Model No. VS820**
- List Price £114.95



£69.95 Exc. VAT
£83.94 Inc. VAT

CAR MECHANICS BEST BUY

2.5L Pneumatic Brake & Clutch Bleeder

NEW Product
2.5L Capacity

- Reservoir holds 2.5L of hydraulic fluid - flush the entire system with one fill, without the risk of running the reservoir dry.
- Pressure range makes the unit suitable for use with ABS systems.
- Fitted with Ø45mm cap with a 90° angled connector.
- Compatible with Sealey VS0204B, VS0204C, VS0204C4, VS0204T, VS820UA and VS820SA brake caps.
- **Model No. VS830**
- List Price £124.95



£99.95 Exc. VAT
£119.94 Inc. VAT

Available Mid April

Universal Brake & Clutch Bleeder Adaptor Cap



- Universal brake and clutch bleeder adaptor cap fits most vehicles.
- 90° Rotating coupling with height adjustment for use where space is limited.
- Adjustable securing wings connect to the master cylinder filling neck 114-180mm.
- Brake fluid resistant EPDM rubber. Cap size Ø26-79mm.
- Heavy-duty chrome steel construction.
- **Model No. VS0204UA**
- List Price £69.95

£59.95 Exc. VAT
£71.94 Inc. VAT

3L Pneumatic Brake Bleeder

3L Capacity
Pneumatic

- One-person professional pneumatic brake bleeding tool.
- Pressure range makes unit suitable for use with ABS systems.
- Reservoir holds 3L - plenty to flush a whole system without the risk of running dry.
- Two drainage method options allow you to drain brake fluid via the brake caliper with the bottle option for replenishing, or brake reservoir pressurising for full brake bleed.
- **Model No. VS0215**
- List Price £159.95



£119.95 Exc. VAT
£143.94 Inc. VAT

14 Tonne Hydraulic Floating Brake Disc Press

Hydraulic

- Commercial 14 Tonne brake disc press set for the removal of seized brake discs from hub assemblies.
- Low-profile rams sit between the disc and hub with two independent regulator valves providing safe controlled detachment.
- Rams closed/open height range between 83-128mm.
- Compatible with male 1/4" BSP threads.
- Applications: DAF, Renault and Volvo commercial vehicles.
- Use in conjunction with RE83/840/CWH Hydraulic Air Pump or RE9710-01 Hydraulic Manual Pump (not included).
- **Model No. CV050**
- List Price £999.95



£899.95 Exc. VAT
£1,079.94 Inc. VAT

NEW Product

Brake Fluid Tester - Boil Test

12V



- The approved method of testing the water content of brake fluid.
- Just 3% of moisture can lower the brake fluid boiling point by over 100°C.
- The best way to detect this small water content is to measure the boiling point of the fluid.
- The unit incorporates a heater element, LCD display and a power lead for use on 12V DC power supplies.
- Works on DOT 3, 4, 5 and 5.1 specification fluids.
- Supplied in storage case with full operating instructions.
- **Model No. VS0275**
- List Price £233.95

£179.95 Exc. VAT
£215.94 Inc. VAT

12V Brake & Clutch Pressure Bleeding Kit

12V

2L



- Powered by the vehicle's own 12V battery.
- Allows single-handed bleeding of the vehicle's brake or clutch system and unit is fitted with a long, high pressure hose.
- Bleed pressure is closely controlled up to 2.5bar - suitable for most vehicles (even those with ABS).
- Unit fitted with auto-shut-off device to prevent the system running dry and is supplied with a variety of European, Japanese and US vehicle adaptors, bleed bottle and fluid extractor.
- Tank Capacity: 2L.
- Cable/Hose Length: 4/5m.
- **Model No. VS0207**
- List Price £784.95

£629.95 Exc. VAT
£755.94 Inc. VAT

5pc Brake Caliper Slogging Wrench Set

3/4" Sq Drive

- Used for installing and removing the brake caliper bolts on commercial vehicles.
- Designed with a 3/4" Sq drive for use with a torque wrench.
- Formula for calculating the correct effective length lasered on wrench.
- Two striking faces for access and aiding in loosening of bolts.
- 3/4" Sq Drive TRX-Star*; E18, E20, E24 and Bi-Hex (12-point); 24, 26mm.
- TRX-Star* Applications: E18 - Man TGL/TGM, E20 - Man TGL/TGM, E24 - Man TGA/TGS/TGX.
- Bi-Hex (12-point) Applications: 24mm - SAF, 26mm - DAF XF/XF95/XF105/XF106.
- **Model No. CV212**
- List Price £176.95



£149.95 Exc. VAT
£179.94 Inc. VAT

On-Vehicle Hydraulic Brake Pipe Flaring Kit

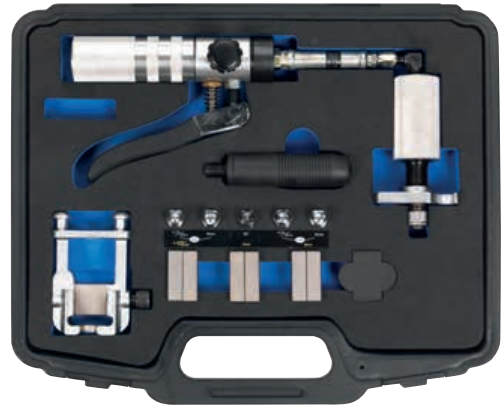

- Produces accurate automotive SAE and DIN flares on 3/16", 4.75mm, 5mm and 6mm brake pipes.
- Ideal for splicing in replacement sections of brake pipe.
- Powerful, lever operated hydraulic ram makes it suitable for steel pipes.
- Features quick release chuck, twist lock die block housing for fast assembly and rotating hydraulic pipework to give easy-access in confined spaces.
- **Model No. PFT15**
- List Price £499.95

£349.95 Exc. VAT
£419.94 Inc. VAT

Twin Leg Cylinder Hone

- Flexible drive shaft and adjustable cutting control.
- Fitted with 28.5mm (1-1/8") medium grade stones with adjustable capacity from Ø20 to 64mm.
- Suitable for small brake cylinders.
- **Model No. VS022**
- List Price £17.95



£12.95 Exc. VAT
£15.54 Inc. VAT

Brake Shoe Spreader Volvo Truck



- Locks the brake shoe open, allowing the shoe lining to be replaced.
- A must have tool for servicing front and rear brakes on Volvo commercial vehicles.
- **Model No. CV013**
- List Price £174.95

£129.95 Exc. VAT
£155.94 Inc. VAT

Left-Handed Brake Piston Wind-Back Tool with Double Adaptor



- Double end tool.
- Enables retraction of the piston on rear brake calipers allowing new brake pads to be installed.
- **Model No. VS0247**
- List Price £27.95

£12.95 Exc. VAT
£15.54 Inc. VAT

Cylinder Hone Stone Set 3 x 1-1/8" Fine

- Application: VS022.
- **Model No. VS0222**
- List Price £8.85



£6.95 Exc. VAT
£8.34 Inc. VAT

30pc Brake Piston Wind-Back Tool Kit

30pc



- Comprehensive master set of adaptors for a wide range of vehicle applications.
- Suitable for push-back and wind-back brake pistons.
- Includes left and right-handed thrust bolt assemblies.
- Left-handed thrust bolt required for Ford, Citroen and Renault applications.
- Kit helps prevent damage to pistons and seals.
- Applications: Alfa Romeo, Audi, BMW, Citroen, Fiat, Ford, Honda, Jaguar, Lancia, Lincoln, Mazda, Mitsubishi, Nissan, Peugeot, Proton, Renault, Rover, Saab, Seat, Subaru, Toyota, Vauxhall/Opel, Volvo, VW.
- **Model No. VS0285**
- List Price £103.95



£81.95 Exc. VAT
£98.34 Inc. VAT

29pc Air Operated Brake Wind-Back Tool Kit

29pc **AIR Operated**

- Air operated wind-back tool suitable for left or right-hand wind-back operations.
- Fast, lightweight and easy-to-use.
- Master set of adaptors suit a wide range of vehicle applications.
- Suitable for push-back and wind-back brake pistons.
- Left-handed thrust required for Citroen, Ford and Renault applications.
- Interchangeable adaptor plates with thrust bolt assembly and reaction plate.
- Includes 3/8" Sq drive adaptor and 2-pin magnetic adaptor for added flexibility.
- Kit helps prevent damage to pistons and seals.
- Applications: Alfa Romeo, Audi, BMW, Citroen, Fiat, Ford, Honda, Jaguar, Lancia, Lincoln, Mazda, Mini, Mitsubishi, Nissan, Peugeot, Proton, Renault, Rover, Saab, Seat, Subaru, Toyota, Vauxhall/Opel, VW, Volvo.
- **Model No. VS0286**
- List Price £228.95

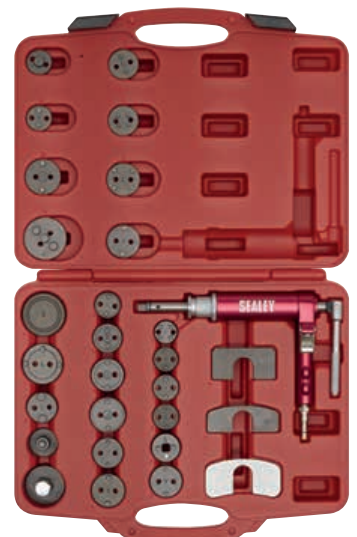

£169.95 Exc. VAT
£203.94 Inc. VAT

Digital Tyre Tread Depth Gauge DVSA Approved



- Calibrated and DVSA approved for testing all classes of vehicle.
- Hardened and tempered stainless steel gauge.
- Selectable Metric or Imperial read-out.
- Zero reset control for comparative measurement.
- Range: 0-10mm(0-0.4"), Accuracy: ±0.01mm(0.0005").
- Includes flat surface plate for accurate zeroing.
- Supplied in storage case.
- **Model No. VS0563**
- List Price £79.95

£52.95 Exc. VAT
£63.54 Inc. VAT

Brake Pedal Depressor DVSA Approved



- Simplifies vehicle testing by allowing any test that requires the brakes to be applied to be carried out by one person rather than two.
- **Model No. VS015**
- List Price £50.95

£34.95 Exc. VAT
£41.94 Inc. VAT

Corrosion Assessment Hammer DVSA Approved



- The only official design of tool fully approved for MOT use in the UK.
- Metal shaft and composite body in accordance with DVSA specification.
- Specially constructed to reduce breakages when dropped.
- Check for the DVSA approved markings.
- **Model No. H1MOT**
- List Price £25.95

£17.95 Exc. VAT
£21.54 Inc. VAT

12V 13-Pin Towing Socket Tester DVSA Approved



12V



- DVSA Approved for use in testing stations on vehicle classes 4, 5 and 7.
- Quick and simple test of 12V 13-pin Euro-type sockets fitted to the rear of the vehicle.
- Supplied with 4.9m cable to enable the operator to use the tool whilst sitting in the vehicle.
- Features self-test facility to ensure the serviceability of the tool.
- Powered by 12V vehicle supply.
- Also tests the 12V continuous/ignition live feeds and the reversing lights - not part of the current MOT test, but useful when diagnosing electrical faults.
- Includes 13 to 7-pin adaptor for testing older wiring systems.
- **Model No. TST22**
- List Price £103.95



£74.95 Exc. VAT
£89.94 Inc. VAT

MOT Tool Board with Tools



- Shadow board with MOT approved and compliant tools.
- Keeps tools organised and in one location.
- Wall mounting and supplied with fitting kit.
- Package includes:**
 - AK989 - 5m(16ft) Rubber Tape Measure
 - H1MOT - Corrosion Assessment Hammer - DVSA Approved
 - S0837 - 400mm Heel Bar
 - TST/DG - Tyre Tread Depth Gauge DVSA Approved
 - TSTPG8 - 6-50psi Universal Deluxe Tyre Pressure Gauge
 - TST22 - 12V 13-Pin Towing Socket Tester - DVSA Approved
 - VS0210 - Brake & Fuel Pipe Inspection Tool
 - VSTL760 - 760mm Tyre Lever
 - WB02 - 260mm Engineer's Wire Brush with Steel Fill
 - MOTB - MOT Tool Board
- **Model No. MOTBKIT**
- List Price £269.95

£169.95 Exc. VAT
£203.94 Inc. VAT

Workshop Headlamp Beam Setter

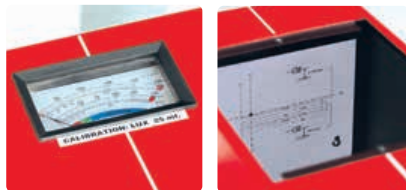

- Suitable for pre-MOT inspection in garages and bodyshops.
- Utilises same optical box and aiming screen as fitted to our MOT approved headlamp beam setter.
- Fixed aiming screen. Internal analogue LUX meter for accurate light intensity measurement.
- Suitable for all types of cars and light commercial vehicles.
- Fitted with fixed column and rubber wheels.
- **Model No. HBS2001**
- List Price £879.95



£749.95 Exc. VAT
£899.94 Inc. VAT

Headlamp Beam Setters with Rails DVSA Approved



- DVSA Approved for use in testing stations.
- Fixed aiming screen.
- Internal analogue LUX meter for accurate light intensity measurement.
- Supplied with rails, instructions and certificate of approval.
- Model No. HBS97 is suitable for all types of motorcycles, cars and light commercial vehicles.
- Model No. HBS97.HGV is supplied with a Commercial Aiming Screen and is suitable for all types of motorcycles, cars, light commercial, PSV and commercial vehicles at MOT test stations that are also class VI and HGV certified.



Model No.	Suitability	List Price	Exc. VAT	Inc. VAT
HBS97	Classes: I, II, III, IV, V, VII	£1,349.95	£999.95	£1,199.94
HBS97.HGV	Classes: I, II, III, IV, V, VI, VII, HGV	£1,599.95	£1,199.95	£1,439.94

Master Locking Wheel Nut Removal Set



- Simple-to-use master kit capable of removing practically any locking wheel nuts.
- Kit includes shroud, which protects the wheel against any damage.
- Very effective and a must have workshop tool.
- Replacement disposable cutters available, Model No. SX299DB (Pack of 10).
- For distribution to bona fide vehicle dealers and repair centres only.
- **Model No. SX299**
- List Price £189.95

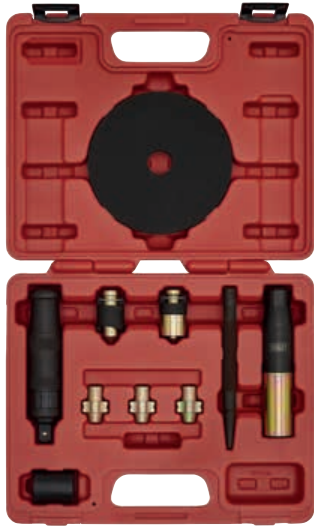

£139.95 Exc. VAT
£167.94 Inc. VAT

Hub Cleaner

1/2"
Sq Drive



- Removes surface dirt and corrosion on hubs that use wheel bolts.
- Ideal for preparing wheels, hubs and brake discs or drums for re-assembly.
- Use with 1/2" Sq drive adaptor.
- **Model No. VS8001**
- List Price £77.95

£42.95 Exc. VAT
£51.54 Inc. VAT

Wheel Stud Cleaning Tool Set



- Quick and easy wheel stud cleaning tool.
- Supplied with a 1/2" Sq drive/1/4" Hex adaptor.
- Brushes; 12mm(7/16"), 13mm(1/2"), 14mm(9/16"), 16mm(5/8"), 22mm(7/8"), 28mm(1-1/8").
- Quick change brushes, use with cordless drill (Max. Speed 1800rpm) or by hand.
- **Model No. VS8003**
- List Price £45.95

£26.95 Exc. VAT
£32.34 Inc. VAT

11pc Ball Joint Socket Set

1/2"
Sq Drive



- Chrome Molybdenum, 4-tooth sockets specially designed to remove castellated locknut found on ball joints, axles and other applications.
- Blackened finish provides corrosion resistance.
- **Model No. CV025**
- List Price £249.95

£199.95 Exc. VAT
£239.94 Inc. VAT

37pc Bearing & Seal Installation Kit

MM



- Lightweight design for the installation of bearings without damaging the bearing or housing.
- Contains three metal bearing drift sleeves and 34 nylon drifts.
- Can also be used to install oil seals.
- Fits most sizes of bearing and seals found on modern vehicles.
- **Model No. VS7024**
- List Price £159.95

£124.95 Exc. VAT
£149.94 Inc. VAT

5pc 1/2" Sq Drive Torque Stick Set

1/2"
Sq Drive



- Chrome Molybdenum steel torque sticks designed for use with air and electric impact wrenches.
- Prevents over-torque of wheel nuts.
- Anodised aluminium colour-coding for easy selection.
- Features a twist distortion marking for checking serviceability of tool.
- **Model No. AK2242**
- List Price £82.95

LIFETIME
GUARANTEE

£54.95 Exc. VAT
£65.94 Inc. VAT

1/2" Sq Drive Torque Sticks



- Chrome Molybdenum steel torque sticks designed for use with air and electric impact wrenches.
- Prevents over-torque of wheel nuts.
- Anodised aluminium colour-coding for easy selection.
- Features a twist distortion marking for checking serviceability of tool.

Model No.	Colour	Torque Rating	List Price	Exc. VAT	Inc. VAT
VS2243	Green	65lb.ft(90Nm)	£22.95	£14.95	£17.94
VS2244	Black	75lb.ft(100Nm)	£22.95	£14.95	£17.94
VS2245	Gold	80lb.ft(110Nm)	£22.95	£14.95	£17.94
VS2246	Red	90lb.ft(120Nm)	£22.95	£14.95	£17.94
VS2247	Blue	100lb.ft(135Nm)	£22.95	£14.95	£17.94

8pc 1/2" Sq Drive Torque Stick & Alloy Wheel Impact Socket Set

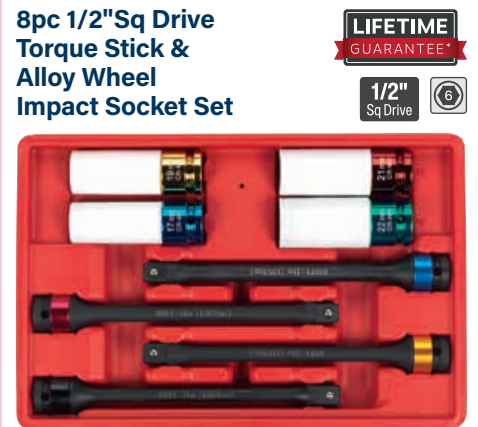

- Chrome Molybdenum torque sticks and impact sockets designed for use with air and electric impact wrenches.
- Colour-coded for easy selection.
- Socket Sizes: 17-22mm.
- Impact sockets are sleeved to prevent damage to alloy wheels and nuts.
- Stick ratings 75-100lb.ft.
- Ideal for fast fit operations.
- **Model No. AK2243**
- List Price £114.95

LIFETIME
GUARANTEE

1/2"
Sq Drive

£79.95 Exc. VAT
£95.94 Inc. VAT

3pc 1/2" Sq Drive Alloy Wheel Long Reach Impact Socket Set

1/2" Sq Drive 6 MM

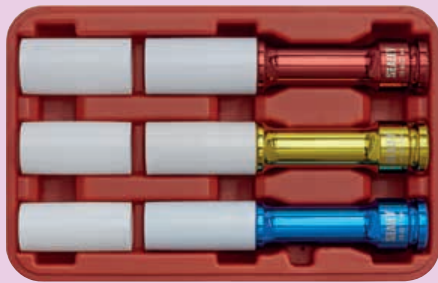

- Anodized Chrome Molybdenum 1/2" Sq drive sockets.
- Suitable for use with impact tools.
- Features nylon sleeve and insert to prevent damage to alloy wheels.
- Colour-coded sockets for easy size selection.
- Comprises long reach 17, 19 and 21mm 1/2" Sq drive sockets, plus spare nylon sleeves.
- **Model No. SX031D**
- List Price £93.95

£54.95 Exc. VAT
£65.94 Inc. VAT

3pc 1/2" Sq Drive Alloy Wheel Ultra-Power Impact Socket Set

Premier

LIFETIME GUARANTEE

1/2" Sq Drive 6 MM



- Five times stronger than the conventional design and tested to 500Nm.
- Innovative design features a protective metal colour-coded ring that prevents the socket wall spreading.
- Each socket is sleeved and has an insert to prevent damage to alloy wheels and nuts.
- Sizes: 17, 19, 21mm.
- **Model No. SX039**
- List Price £69.95

£39.95 Exc. VAT
£47.94 Inc. VAT

19L Bead Seating Tools

19L AIR Operated



Model No. TC900



Model No. TC904

- The easy and instant way to seat tubeless tyre beads.
- Dumps air into tyre void forcing bead to seat against rim for inflation.
- Model No. TC900 air release is controlled by a hand lever operating a ball valve.
- Model No. TC904 air release is controlled by a diaphragm valve and push-button trigger and features slotted key to prevent accidental operation of the trigger.
- Fully certified tank with gauge and safety valve prevents over pressurising.
- Suitable for use on cars, commercials, agricultural and ATV tyres.

Model No.	Trigger Type	List Price	Exc. VAT	Inc. VAT
TC900	Lever	£309.95	£239.95	£287.94
TC904	Push-Button	£349.95	£259.95	£311.94

Foot Pumps



Model No. FP1



Model No. FP2



Model No. FP4

- Steel framed foot pumps with steel barrels.
- Flexible hoses with locking connectors.

Model No.	Type	Gauge Range	Hose Length	List Price	Exc. VAT	Inc. VAT
FP1	Single Barrel	0-100psi(0-7bar)	610mm	£17.95	£11.95	£14.34
FP2	Twin Barrel	0-100psi(0-7bar)	610mm	£26.95	£19.95	£23.94
FP4	Twin Barrel	0-100psi(0-7bar)	1020mm	£29.95	£21.95	£26.34

Tyre Bar for Aluminium Wheels



- Tyre bar fitted with nylon ferrules to prevent damage to aluminium wheel rims.
- Suitable for use with Model No's TC960, TC962 (see right) and TC965.
- Also compatible with other makes of manual tyre changer.
- **Model No. TC963**
- List Price £144.95

£99.95 Exc. VAT
£119.94 Inc. VAT

Manual Tyre Spreader with Stand



- Floor standing unit for spreading vehicle tyres before carrying out repairs.
- Features rollers to rotate the tyre to the correct position and fully adjustable platform.
- Suitable for most cars and light commercial vehicles.
- **Model No. TC970**
- List Price £319.95

£259.95 Exc. VAT
£311.94 Inc. VAT

Manual Tyre Changer

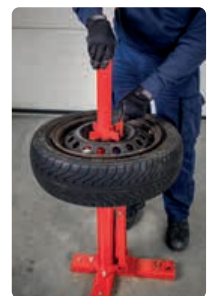

- Steel construction with manual bead breaker.
- Suitable for use on most open centred wheels.
- Wheel Depth Minimum/Maximum: 0/300mm.
- Wheel Diameter Minimum/Maximum: Ø190/430mm.
- Supplied with tyre bar.
- To prevent damage to alloy wheel rims, use Model No. TC963 Tyre Bar.
- **Model No. TC960**
- List Price £181.95

£109.95 Exc. VAT
£131.94 Inc. VAT

Pneumatic/Manual Tyre Changer

Pneumatic

AIR Operated



Suitable for use on most automotive/light commercial open centred wheels.



Heavy steel construction.



Supplied with standard tyre bar and PCL couplings.



Min./Max. Wheel Clamping Size: 203/460mm(8"/18").

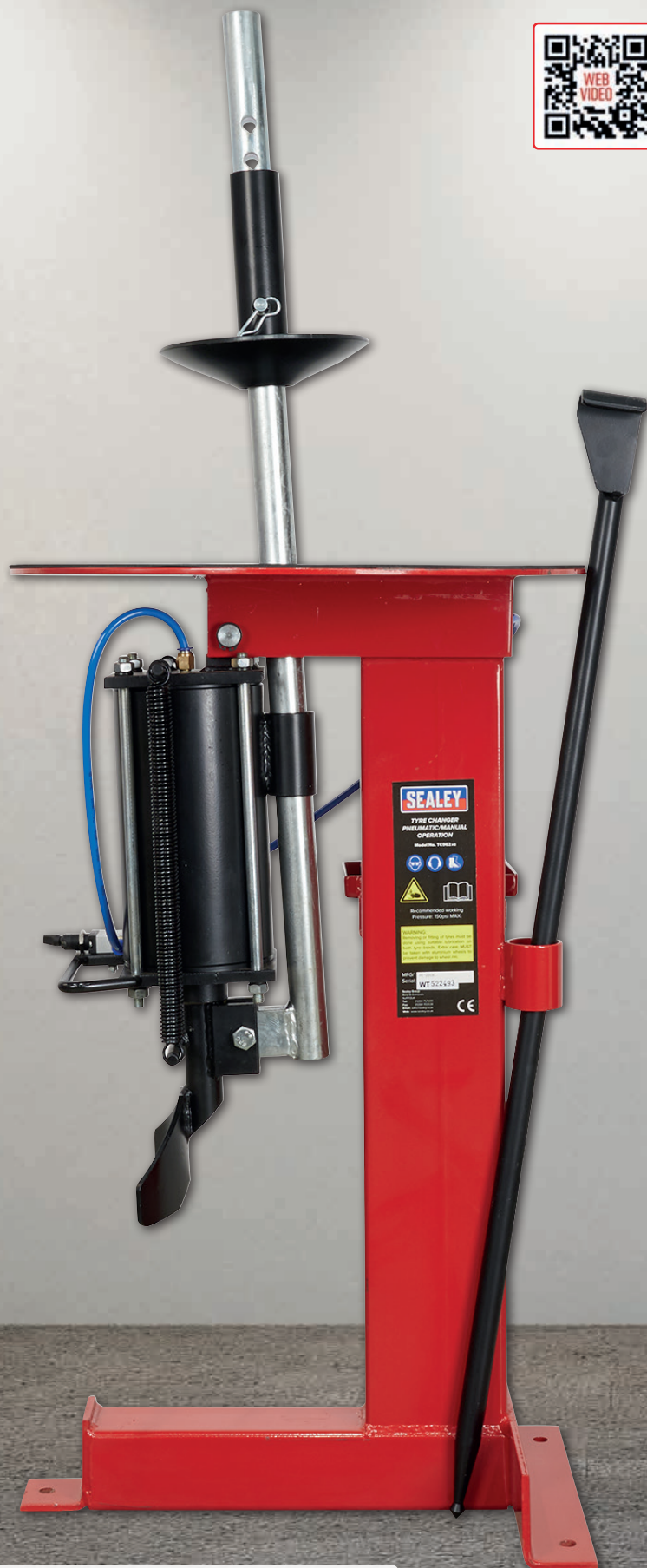

- Pneumatic bead breaker.
- Features additional air line coupling for tyre inflator.
- To prevent damage to the rims of the alloy wheel, it is essential to use a Model No. TC963 Tyre Bar (see left).
- **Model No. TC962**
- List Price £929.95

£649.95 Exc. VAT
£779.94 Inc. VAT

12V Heavy-Duty Tyre Inflator/Mini Air Compressors

12V **HEAVY DUTY** 100psi OR 150psi

- 0.88 cfm
- 1.77 cfm
- 2.65 cfm
- OR
- 3.35 cfm



Model No. MAC05

- Features air hose with quick release coupling and 3m power cord with accessory plug.
- Supplied in a storage bag with accessory kit.

Model No.	Hose Length	Air Delivery	Max. Pressure	List Price	Exc. VAT	Inc. VAT
MAC04	1.5m	25L/min	100psi	£72.95	£54.95	£65.94
MAC05	4.5m	50L/min	150psi	£114.95	£89.95	£107.94
MAC06	7.5m	75L/min	150psi	£179.95	£139.95	£167.94
MAC07	7.5m	95L/min	150psi	£239.95	£174.95	£209.94

12V Heavy-Duty Tyre Inflator/Mini Air Compressors

12V **HEAVY DUTY** 100psi



Model No. MAC05D

- Will automatically inflate tyres to preset pressure without the need for fiddly gauges.
- Suitable for inflating tyres on lawnmowers, motorcycles, cars and vans.
- Supplied in a storage bag with accessory kit including ball needle and adaptors for inflatables.

Model No.	Hose Length	Air Delivery	Max. Pressure	List Price	Exc. VAT	Inc. VAT
MAC04D	2m	25L/min	100psi	£94.95	£74.95	£89.94
MAC05D	4.5m	50L/min	100psi	£139.95	£99.95	£119.94

12V Tyre Inflator & Emergency Puncture Sealant Kit

12V 100psi

- Emergency kit includes 12V compressor, 450ml sealant bottle, accessories for inflatables, instructions and zipped storage bag fitted with hook-and-loop fastening for smart storage.
- Can seal a puncture up to Ø6mm at the roadside in under 10 minutes.
- Sealant is manufactured from natural rubber, meaning tyre can be washed out at the point of a professional repair.
- Very simple-to-use kit requires no tools, no need to remove the valve core and is TPMS safe.
- Plugs into a 12V vehicle accessory socket.
- Replacement sealant bottle available Sealey Model No. MAC10SR.
- Suitable for cars, vans and 4x4s.
- Maximum Pressure: 100psi.
- **Model No. MAC10S**
- List Price £43.95



£31.95 Exc. VAT
£38.34 Inc. VAT

450ml Replacement Tyre Sealant & Hose



- Emergency tyre sealant refill with hose for Sealey Model No. MAC10S.
- Can seal a puncture up to Ø6mm.
- Sealant is manufactured from natural rubber, meaning tyre can be washed out at the point of a professional repair.
- TPMS Safe.
- Suitable for cars, vans and 4x4s.
- **Model No. MAC10SR**
- List Price £21.95

£14.95 Exc. VAT
£17.94 Inc. VAT

Digital Tyre Inflator with 2.7m Hose & Clip-On Connector

0-174psi



- Die-cast aluminium body with large rubber bumper, backlit LCD digital display and battery level indicator.
- Auto-power-off after 8 seconds and auto-power-on once pressure is sensed, or air inflation starts.
- 2.7m Flexible hose fitted with clip-on air connector.
- **Model No. SA375**
- List Price £134.95



£89.95 Exc. VAT
£107.94 Inc. VAT

Airlite Eco Tyre Inflators



- Manufactured from nylon polymer and robust glass.
- Ergonomic lightweight design with textured thumb lever.
- Increased window size ensures clearer vision and better accuracy.
- Linear pressure scale, dual calibrated in psi and bar.

Model No.	Connector Type	Hose Length	List Price	Exc. VAT	Inc. VAT
SA37/98	Clip-On	255mm	£84.95	£69.95	£83.94
SA37/99	Twin Push-On	205mm	£84.95	£69.95	£83.94



Model No. SA37/98



Model No. SA37/99 connector.

Professional Tyre Inflators

0-140psi

3 YEAR GUARANTEE



- Manufactured to comply with EN 12645.
- Aluminium body with rubber bumper.
- Linear pressure scale, dual calibrated in psi and bar, with parallax correction.
- Range: 0-9.6bar(0-140psi).
- Supplied with a serial numbered calibration certificate.

Model No.	Connector Type	Hose Length	List Price	Exc. VAT	Inc. VAT
SA37/93	Twin Push-On	0.5m	£104.95	£89.95	£107.94
SA37/95	Twin Clip-On	2.5m	£154.95	£124.95	£149.94



Model No. SA37/93



Model No. SA37/95 connector.

Digital Tyre Pressure Gauges

0-150psi

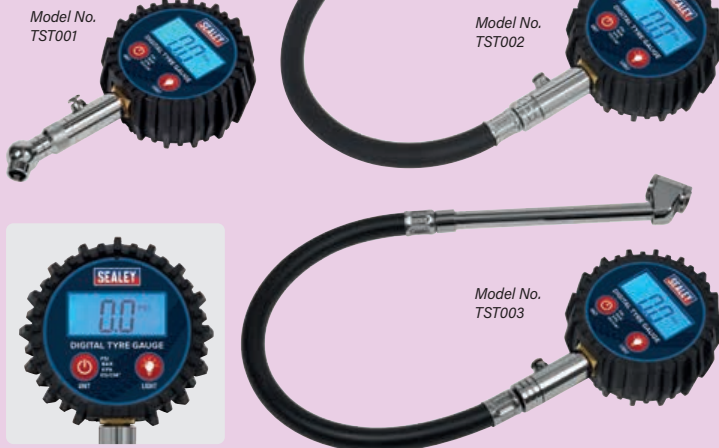

- Die-cast body and digital type gauges.
- Displayed in psi, bar, kpa and kg/cm².
- Supplied with a protective soft rubber cover.
- Pressure release valve.
- Auto-power-off function.
- Range: 0-150psi.
- Requires 2 x AAA batteries (supplied).

Model No.	Type	List Price	Exc. VAT	Inc. VAT
TST001	Swivel Head with Quick Release	£22.95	£17.95	£21.54
TST002	Swivel Head with Hose and Push-On Connector	£29.95	£23.95	£28.74
TST003	Swivel Head with Hose and Push-On Chuck	£36.95	£27.95	£33.54



Emergency Breakout Tool With Tyre Tread Depth Gauge



- Trigger action and hardened tip shatters glass with minimum effort.
- Designed for 5mm automotive tempered glass.
- Recessed seatbelt cutter provides fast and effective method of escape.
- Tyre tread depth gauge offers a quick and easy check of tread level.
- **Model No. TST19**
- List Price £9.95

£6.95 Exc. VAT
£8.34 Inc. VAT

940mm Tyre Lever - Commercial



- Carbon steel tyre lever with hook ends.
- Suitable for use on commercial vehicle tyres.
- **Model No. VSTL940**
- List Price £74.95

£47.95 Exc. VAT
£57.54 Inc. VAT

Tyre Tread Depth Gauge DVSA Approved



- Chromed steel body with pocket-clip.
- DVSA Approved depth scale includes 1.6mm graduation for minimum tyre tread requirements.
- Scale from 0-26mm in 1mm graduations.
- **Model No. TST/DG**
- List Price £9.45

£6.45 Exc. VAT
£7.74 Inc. VAT

Tyre Pressure Gauge

5-50psi



- Pencil type gauge with psi scale.
- Features valve deflator and pocket-clip.
- Suitable for use as a guide.
- Scale: 5-50psi.
- **Model No. TSTPG1**
- List Price £5.25

£3.75 Exc. VAT
£4.50 Inc. VAT

Suspension Arm Lever



- Suitable for the in situ separation of suspension components with minimum manual effort and maximum efficiency.
- Fully adjustable fulcrum position allows for use in a variety of positions and caters for left or right-handed use.
- **Model No. VS3815**
- List Price £149.95

£109.95 Exc. VAT
£131.94 Inc. VAT

Track-Rod Adjusting Grips



- Designed for loosening and adjusting stubborn track-rods when making repairs or adjusting the wheel alignment.
- Ideal when the tie-rod has no hex or flats and a spanner cannot be used.
- Features a spring loaded jaw which grips tighter as more force is applied.
- Length: 410mm.
- Maximum Capacity: 22mm.
- **Model No. VS4005**
- List Price £85.95

£59.95 Exc. VAT
£71.94 Inc. VAT

Wheel & Tyre Handling Dolly

127kg Capacity

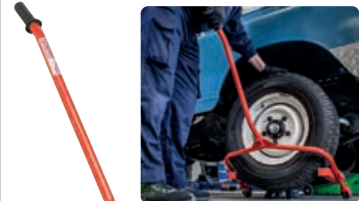

- For commercial sized wheel and tyre removal/installation.
- Fork Centres: 535mm.
- Length: 1255mm.
- **Model No. TH002**
- List Price £124.95

£89.95 Exc. VAT
£107.94 Inc. VAT

1500kg Hydraulic Coil Spring Compressing Station

1500kg

Hydraulic



- 1500kg Capacity foot-operated hydraulic unit.
- Quicker and easier than using ratchet driven spring compressor.
- Plastic coated yokes reduce the risk of spring slippage/damage.
- Suitable for springs from Ø80mm to Ø175mm.
- **Model No. RE231**
- List Price £434.95

£299.95 Exc. VAT
£359.94 Inc. VAT



Professional Coil Spring Compressor Set Right-Hand/Left-Hand

2500kg



- Suitable for MacPherson strut coil springs.
- Supplied with five pairs of different sized interchangeable yokes, for right and left-handed coil springs.
- Plastic yoke protectors that protect the spring coating from damage, which can invalidate the vehicle manufacturer's guarantee.
- Safety yokes carefully shaped to stop the spring bowing while under compression.
- **Model No. RE249**
- List Price £479.95

£319.95 Exc. VAT
£383.94 Inc. VAT



1000kg Air Operated Coil Spring Compressor

1000kg

AIR Operated



Fast and safe compression of road springs.



Air operated unit with safety locking guard.



Supplied with two interchangeable plastic coated lower yokes and a suspension strut clamp.



Foot-operated hydraulic unit.

- Fits a wide range of spring configurations and diameters.
- Also features a strut locating platform for easy movement of the suspension strut to avoid unnecessary lifting.
- **Model No. RE300**
- List Price £1,169.95

£999.95 Exc. VAT
£1,199.94 Inc. VAT



This item is heavy. Extra assistance must be provided at the delivery point to help safe delivery.

4-Wheel Laser Wheel Aligner Combo



 This item is heavy.
Extra assistance
must be provided at
the delivery point to
help safe delivery.



**FAST, SIMPLE AND ACCURATE ALIGNMENT
OF BOTH FRONT AND REAR WHEELS.**

**THIS FULLY PORTABLE KIT IS ALSO IDEAL FOR
TRACK-DAY SET-UP FOR THE ENTHUSIAST.**

**OPTIMISES VEHICLE PERFORMANCE AND SET-UP
AFTER INSTALLATION OR MODIFICATION OF
STEERING AND SUSPENSION COMPONENTS.**

**SUPPLIED WITH STEERING WHEEL CLAMP, WHEEL
TURN PLATES AND WHEELED STORAGE RACK AND
COMPREHENSIVE OPERATING INSTRUCTIONS.**



Package includes:

- GA70 - 4-Wheel Laser Wheel Aligner
- GA70CR - Calibration Rig for GA70
- **Model No. GA70COMBO**
- List Price £2,399.95

£1,899.95 Exc. VAT

£2,279.94 Inc. VAT

Steering Wheel Level



- Used to level the steering wheel before locking into position, prior to checking/adjusting the front wheel alignment.
- Ideal for use with 4-Wheel Laser Aligners such as Model No. GA70 (see page 53).
- Self-retaining and centring using a spring loaded mechanism.
- Features a level bubble to show horizontal position.
- Suitable for steering wheels with an internal diameter of between Ø270mm and Ø340mm.
- **Model No. GA460**
- List Price £70.95

£49.95 Exc. VAT
£59.94 Inc. VAT

2pc 1/2" Sq Drive Strut Leg Pry Socket Set

LIFETIME GUARANTEE

1/2" Sq Drive



- Reduces risk of damage to hub casting.
- Includes two sizes of pry socket: 7 x 5mm and 8.2 x 5.5mm.
- Suitable for removal and installation of strut legs on most Audi, Ford, Peugeot, Renault, Seat, Skoda, VW.
- **Model No. SX034**
- List Price £17.95

£12.45 Exc. VAT
£14.94 Inc. VAT

18pc Shock Absorber Strut Nut Kit

1/2" Sq Drive



- Permits the removal of the top suspension nut by holding the strut piston, so it doesn't rotate while turning the nut.
- The go-through design of the socket and ratchet allows the extension to pass through the middle.
- To be used in conjunction with a 1/2" Sq drive ratchet or T-bar (not included).
- Go-Through Ratchet: 21mm.
- Go-Through 82mm Deep Sockets: 16, 17, 18, 19, 21, 22, 24mm.
- Extensions: Female Hex; 7, 8, 9mm, Male Hex; 6, 7, 8mm, Slotted; 5 x 8, 6 x 8, 71 x 9.6mm, TRX-Star*; T50.
- **Model No. VS0331**
- List Price £134.95



£117.95 Exc. VAT
£141.54 Inc. VAT

Suspension Strut Support

Developed by **SEALEY**



- Designed to support suspension struts during repair operations.
- To be used in conjunction with Sealey Model No. 600TR or other transmission jacks with a minimum base size of 560mm x 570mm.
- Only use with a ram size of Ø30mm.
- Developed by Sealey.
- **Model No. VS3847**
- List Price £114.95



£87.95 Exc. VAT
£105.54 Inc. VAT

24pc Suspension Strut Socket Set

3/8" Sq Drive



- Sockets manufactured from Chrome Vanadium steel.
- Permits the removal of the top suspension nut by holding the strut piston, so it doesn't rotate while turning the nut.
- The go-through design of the socket and ratchet allows the extension to pass through the middle.
- To be used in conjunction with a 3/8" Sq drive ratchet or T-bar (not included).
- Sizes: Go-Through Sockets Standard and Deep; 16, 17, 18, 19, 21, 22mm, 8mm Hex Bits; Hex - 5, 6, 7, 8mm, Spline - M10, TRX-Star* - T50, Shock Absorber Strut Sockets (x4), 3/8" Sq Drive Extension Bars; 90, 190mm.
- **Model No. VS0332**
- List Price £169.95

£39.95 Exc. VAT
£47.94 Inc. VAT

Rear Axle Bush Tool - Ford Fiesta IV, Ka



- Remove/install Fiesta IV rear axle mounting bushes.
- Can be used in situ - no need to remove trailing link assembly from vehicle.
- Applications: Ford; Fiesta IV (96on), Ka.
- **Model No. VSE4779**
- List Price £149.95

£99.95 Exc. VAT
£119.94 Inc. VAT

Ball Joint Splitter



- Chemically blackened forged steel body with thrust bolt.
- Suitable for most small cars and light vans.
- Jaw Width: 19mm.
- **Model No. AK381**
- List Price £27.95

£14.95 Exc. VAT
£17.94 Inc. VAT

Ball Joint Splitter - Commercial



- Chemically blackened forged steel body with thrust bolt.
- Maximum Opening: 65mm.
- Jaw Width: 30mm.
- Suitable for commercial applications.
- **Model No. VS3812**
- List Price £194.95

£154.95 Exc. VAT
£185.94 Inc. VAT

27pc Bearing & Bush Removal/Installation Kit



- Comprehensive kit for fast and effective in situ removal/installation of wheel bearings, suspension bushes and seals.
- Reduces the possibility of damaging the bearing/suspension housings.
- Supplied with 22 adaptors from Ø44 to 90mm and five force screws in storage case.
- Adaptors can also be used in a standard workshop press when in situ access isn't possible.
- **Model No. VS7026**
- List Price £329.95

£269.95 Exc. VAT
£323.94 Inc. VAT

100mm Rear Hub Nut Socket Scania 3/4" Sq Drive

3/4" Sq Drive



- Drop-forged, 8-point, steel impact socket designed for the removal of rear hub nut found on Scania commercial vehicles.
- **Model No. CV004**
- List Price £192.45

£129.95 Exc. VAT
£155.94 Inc. VAT

110mm Axle Nut Socket Iveco H36 Drive



- Chrome Molybdenum, drop-forged, 12-point, high-impact socket designed for the removal of axle nut found on Iveco Eurotech-Cursor.
- **Model No. CV024**
- List Price £284.95

£189.95 Exc. VAT
£227.94 Inc. VAT

3/4" Sq Drive Axle Locknut Sockets

3/4" Sq Drive



Model No. CV021



Model No. CV022

- Chrome Molybdenum, drop-forged.
- Model No. CV021 is a 6-tooth impact socket with detachable inner location sleeve, designed for locknut fitted to MAN TGA axles.
- Model No. CV022 is a 6-stud impact socket with bayonet locking tube, designed for grooved locknut fitted to Mercedes Atego rear axle on Vario 814 and MAN vehicles.

Model No.	Size	List Price	Exc. VAT	Inc. VAT
CV021	133-145mm	£449.95	£299.95	£359.94
CV022	80-95mm	£199.95	£132.95	£159.54

115mm Wheel Shaft Cover Socket Volvo 1" Sq Drive

1" Sq Drive



- Chrome Molybdenum, drop-forged, 8-point, high-impact socket designed for the removal of front and rear axle covers found on Volvo commercial vehicles.
- **Model No. CV006**
- List Price £202.95

£134.95 Exc. VAT
£161.94 Inc. VAT

Trailing Arm Bush Tools



Model No. VSE4784

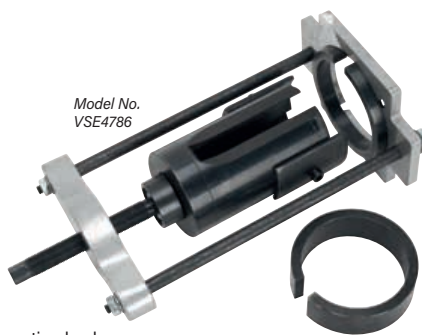

Model No. VSE4786

- Suitable for the removal/installation of the rear trailing arm mounting bushes.
- Can be used in situ without removing the arm from the vehicle.
- Model No. VSE4784 is suitable for Ford vehicles and some Volvo vehicles that share the same Ford platform.
- Model No. VSE4786 is suitable for Ford and Volvo vehicles.
- Both models supplied in a storage case.

Model No.	Applications	List Price	Exc. VAT	Inc. VAT
VSE4784	Ford; Mondeo Mk IV (07on), S-Max (06on), Galaxy (06on), Volvo; S60, S80, XC60, V70, XC70 (06-09) with Ford Platform	£289.95	£139.95	£167.94
VSE4786	Ford; Mondeo Mk IV (07on), S-Max (06on), Galaxy (06on), Volvo; S80 II (07on), S80 II Flexifuel (07on), V70 III (08on), V70 III Flexifuel (08on), V60 D6 Hybrid (14on), V60 (12on), S60 II (10on), XC70 III (08on)	£369.95	£224.95	£269.94

Front Suspension Bush Tool - VAG

VAG



- Suitable for the removal/installation of the rear mounting bush on the front lower wishbone.
- Can be used in situ without removing the aluminium housing.
- Use with 24mm spanner only.
- **Model No. VSE4781**
- List Price £119.95



£79.95 Exc. VAT
£95.94 Inc. VAT

Thread Repair Master Kit

MM



- Suitable for five common sizes of thread (M5 x 0.8mm, M6 x 1mm, M8 x 1.25mm, M10 x 1.5mm and M12 x 1.75mm).
- Creates a stronger internal thread in soft metals.
- Ideal for repairing damaged or stripped internal threads.
- Protects tapped threads against wear and damage.
- Includes drill bits, thread taps, stainless steel thread inserts, insert installation and lug breaking tools.
- **Model No. TRMK**
- List Price £139.95



£99.95 Exc. VAT
£119.94 Inc. VAT

Front Upper Control Arm Bush Tool - VAG

VAG

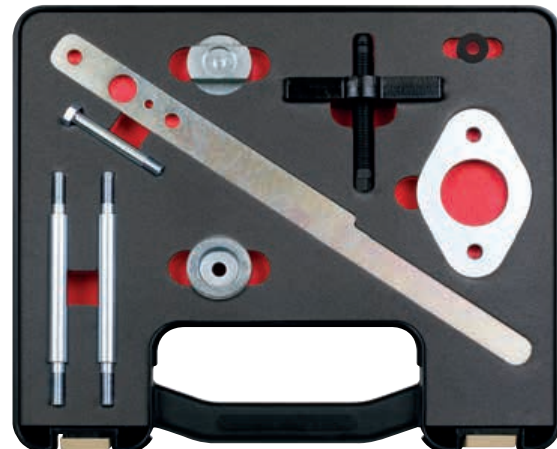

- Time-saving tool suitable for the removal/installation of the front upper control arm bushes on VAG vehicles.
- Can be used in situ without having to remove the control arm from the vehicle, which includes the top pinch bolt which is often seized and prone to snapping.
- **Model No. VSE4789**
- List Price £269.95

£149.95 Exc. VAT
£179.94 Inc. VAT

Battery Chargers

- Compact lead acid battery chargers suitable for home and light workshop use.
- Features easy-to-read ammeter to indicate the level of battery charge.
- Also features overheating, short and reverse polarity protection.
- 1.8m Cable with insulated clamps.
- Model No. DSBC8 includes 6/12V and low/high power selection.



4A
12V
Model No. DSBC4



6A
12V
Model No. DSBC6



8A
6V/12V
Model No. DSBC8

Model No.	Output	Peak Output Charge	Effective Output Charge	Output Fuse	Battery Range	List Price	Exc. VAT	Inc. VAT
DSBC4	12V	4A	2.8A	5A	12-48Ah	£31.95	£24.95	£29.94
DSBC6	12V	6A	4.2A	7.5A	Lead Acid 12-60AH	£37.95	£29.95	£35.94
DSBC8	6V/12V	8A	6V 5.6A (High)/2.5A (Low) 12V 5.6A (High)/3.6A (Low)	10A	50-400mA for Trickle Charging 6V - 28-112Ah (High)/9-36Ah (Low) 12V - 28-112Ah (High)/10-40Ah (Low)	£54.95	£44.95	£53.94

6/12V Auto Maintenance Chargers



5A
6V/12V

Model No. MBC250



2A
6V/12V

Model No. MBC420

- Compact 6/12V battery chargers perfect for automotive, motorcycle and marine workshops.
- Suitable for charging a variety of batteries, these chargers react continuously to battery condition and deliver whatever charge rate is required.
- Constantly regulated voltage patterns allow the battery to be recharged fully and safely without fear of overcharging.
- Compatible with all AGM, Gel and VRLA flooded batteries commonly found in everything from automotive and farm equipment to motorcycles, ATVs, golf buggies and lawnmowers.

Model No.	Banks	Output Charge (Each Bank)	List Price	Exc. VAT	Inc. VAT
MBC250	2	5A	£89.95	£39.95	£47.94
MBC420	4	2A	£124.95	£99.95	£119.94

12V Digital Battery & Alternator Tester

12V

Battery & Alternator



- Compact device which accurately tests battery, cranking and alternator.
- No heat, no sparks and no misdiagnosis.
- Just key in the battery rating from the top of the battery and results are displayed on LED control panel.
- No internal battery and will test batteries with a residual charge of just 7V.
- **Model No. BT01**
- List Price £75.95

£54.95 Exc. VAT
£65.94 Inc. VAT

800A 12V ElectroStart® Batteryless Jump Starter

12V



PATENTED TECHNOLOGY



- Output: 800A (Peak), 400A (EN).
- Innovative patented technology with no internal battery so no need to wait hours for the unit to charge before use.
- Simple and safe to use with no long term battery storage issues.
- Can be fully energised in approximately 2mins.
- Digital display indicates battery voltage, capacitor charge and faults.
- Can also be used as a 0.8A battery maintainer using a USB charging cable (not included) or a 2A battery charger with the addition of Model No. E/START2A Charging Adaptor.
- Compact and lightweight for easy handling and storage, yet still delivers the same result as heavy, bulky, lead acid battery equivalents.
- **Model No. E/START800**
- List Price £159.95

2 YEAR GUARANTEE



CAR RECOMMENDED PRODUCT



2A 15V ElectroStart® Smart Charger Adaptor



- Dual purpose charger for use with our range of E/START digital models.
- Will fully charge an E/START unit within 5 minutes.
- Converts any compatible E/START unit into a 12V battery charger.
- **Model No. E/START2A**
- List Price £22.95

£84.95 Exc. VAT
£101.94 Inc. VAT

£18.95 Exc. VAT
£22.74 Inc. VAT

RoadStart® 12V Jump Starter Power Packs

12V



Model No. RS600
600A
2.5L
4.0L



Model No. RS800
800A
4.0L
6.0L



Model No. RS2000
2000A
8.0L
10L

NEW
Product

- Easily fit in a glove box or backpack and benefit from being compact and lightweight.
- Powered by lithium-ion technology and fully protected against short circuit, overload and reverse polarity.
- USB port for charging electronic devices and integral LED flashlight.
- Waterproof to IP66 or IP67, depending on model.

Model No.	Capacity	Auxiliary Output	Max. Current	Max. Starting Capacity	List Price	Exc. VAT	Inc. VAT
RS600	7.2Ah @ 3.7V or 1.8Ah @ 14.8V	USB (x1) - 5V/2.1A	600A Peak, 300A Cranking	2.5L Diesel/4L Petrol	£74.95	£64.95	£77.94
RS800	10Ah @ 3.7V or 2.5Ah @ 14.8V	USB (x1) - 5V/2.1A	800A Peak, 400A Cranking	4L Diesel/6L Petrol	£94.95	£82.95	£99.54
RS2000	20Ah @ 3.7V or 5Ah @ 14.8V	USB (x2) both - 5V/2A, 9V/1.5A Type-C - 5V/3A, 9V/3A, 12V/3A, 15V/3A, 20V/2.25A and DC Output 15V/10A	2000A Peak, 1000A Cranking	8L Diesel/10L Petrol	£189.95	£164.95	£197.94

Solar Power Panels 12V

Solar Powered

- Suitable for maintaining charge in a wide range of batteries and power packs.
- Ideal for batteries stored in boats and caravans and for batteries in vehicles in long-term storage.
- Supplied with battery clips and vehicle accessory socket plug (only suitable for vehicles with "permanent live" accessory socket).
- IP44 Rated (for use behind car windscreen or other protection).



Model No. SPP02

Model No.	Output	Dimensions	List Price	Exc. VAT	Inc. VAT
SPP01	12V/1.5W	350 x 125mm	£31.95	£21.95	£26.34
SPP02	12V/2.4W	370 x 210mm	£49.95	£34.95	£41.94
SPP03	12V/4.8W	440 x 345mm	£89.95	£64.95	£77.94

RoadStart® 1200A 12V Jump Starter & Tyre Inflator

1200A 12V 5.0L 7.0L

- Easily fits in a glove box or backpack and benefits from being compact and lightweight.
- Capable of starting an average 7L petrol or 5L diesel engine.
- Powered by lithium-ion technology and fully protected against short circuit, overload and reverse polarity.
- Fitted with a 12,000mAh lithium-ion battery and two USB Type A outlets (5V/2.4A, 5V/3A, 9V/2A, 12V/1.5A), Type-C input (5V/2A, 9V/2A).
- Digital tyre inflator which reads psi, kpa and bar.
- Maximum Pressure: 120psi.
- Suitable for inflating vehicle tyres, bike tyres, balloons/inflatables and balls.
- Integral LED flashlight with 3 modes (Solid Light, Strobe, SOS).
- Model No. RS1200TI
- List Price £119.95



£99.95 Exc. VAT
£119.94 Inc. VAT

Watertight Hardwired Terminal Connector for SPP01, SPP02 & SPP03



- Battery terminal connection lead with in-line fuse unit.
- Weatherproof cap to offer protection from water ingress when the connector is not in use.
- Can be left on the vehicle and simply connected to Model No's SPP01, SPP02 or SPP03 when required.
- Fitted with 7.5A fuse.
- Cable Length: 570mm.
- Model No. SPP01.A
£4.95 Exc. VAT
£5.94 Inc. VAT
- List Price £6.45

12V/24V PowerStart Emergency Jump Starters

12V/24V



- Among the heaviest duty jump starters currently available, the PowerStart range is designed for the professional technician.
- Housed in heavy steel cases, these units are rugged enough for the toughest environments and can be used on a wide variety of vehicle applications: Trucks, Buses, Coaches, Construction Machines and Vehicles, Towing and Rescue Vehicles, Recovery Vehicles, Airfield Support Vehicles, Light Aircraft, Marine, Farming and Forestry Vehicles.
- Designed and made in the EU, these jump starters offer serious performance for the professional user.
- Cable and Clamp Length 2m.



Model No. POWERSTART500
500hp Start Power

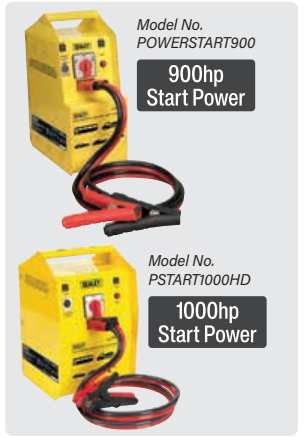

Model No. POWERSTART900
900hp Start Power

Model No. PSTART1000HD
1000hp Start Power

Model No.	Max. Engine Size	Peak Amps	List Price	Exc. VAT	Inc. VAT
POWERSTART500	500hp	12V - 4400A, 24V - 2200A	£1,749.95	£1,299.95	£1,559.94
POWERSTART900	900hp	12V - 5000A, 24V - 2500A	£1,949.95	£1,499.95	£1,799.94
PSTART1000HD	1000hp	12V - 7000A, 24V - 3500A	£2,224.95	£1,699.95	£2,039.94

Air Operated Pistol Type Grease Guns

AIR Operated

- Die-cast heads and bodies with chromed steel grease tube.
- Portable pressure greasing with the convenience of air power.
- Includes rigid delivery tube and 4-jaw coupler.
- Model No. SA40 delivers at a max. grease pressure 1200psi at 30psi air pressure and 6000psi at 150psi pressure.
- Model No. SA401 is a trigger operated continuous flow gun with 3-way fill and air-bleed valve and delivers at a pressure from 2400-6000psi.



Model No. SA40

Continuous Flow



Model No. SA401

Model No.	Type	List Price	Exc. VAT	Inc. VAT
SA40	Standard	£64.95	£42.95	£51.54
SA401	Continuous Flow	£68.95	£44.95	£53.94

9L Manual Vacuum Oil & Fluid Extractor

Siegen

9L Manual Pump

- Constructed from composite materials.
- Uses manual pump to generate vacuum.
- Suitable for the extraction of all types of engine, transmission and lubricating oil from cars, motorcycles, marine engines, stationary engines and industrial machinery.
- Also suitable for low viscosity fluids such as water.
- Supplied with Ø4, Ø6, Ø8 and Ø10 x 1000mm suction probes.
- Brass Extension Tube: Ø4 x 600mm.
- Uses probes to extract engine oil through the dipstick tube.
- **Model No. S01167**
- List Price £119.95



£99.95 Exc. VAT
£119.94 Inc. VAT

5L Gear Oil Dispensing Unit

5L

- Pump operated oil dispensing unit with a 5L capacity.
- Ideal for filling manual transmissions and differentials.
- Supplied with flexible adaptor and 100° angled metal adaptor.
- Features a fluid shut-off valve to prevent accidental spillage.
- Includes a pressure gauge.
- **Model No. VS70096**
- List Price £139.95



£109.95 Exc. VAT
£131.94 Inc. VAT

Double Diaphragm Fuel Transfer Pump



- Self-priming high performance double diaphragm lever pump.
- Heavy-duty die-cast aluminium pump head with stainless steel pistons and fuel resistant nitrile rubber diaphragm.
- 1" BSP Connector and telescopic dip tube to suit 50 to 205L drums.
- Approximately 800ml per full stroke discharge.
- Supplied with 8ft anti-static discharge hose and delivery nozzle with holder.
- Suitable for various oils, petrol, diesel, antifreeze, paraffin and other non-corrosive fluids.
- **Model No. TP6918**
- List Price £229.95



£139.95 Exc. VAT
£167.94 Inc. VAT

205L Drum Dolly



- Transport drums quickly and safely on four large diameter metal castors.
- Wheel positioning ensures even weight distribution enabling easier manoeuvrability.
- Suitable for use with 205L drums.
- **Model No. TP205**
- List Price £109.95

£89.95 Exc. VAT
£107.94 Inc. VAT

9L Manual/Air Vacuum Oil & Fluid Extractor

Siegen

9L

- Suitable for the extraction of all types of engine, transmission and lubricating oil from cars, motorcycles, marine engines, stationary engines and industrial machinery.
- Also suitable for low viscosity fluids such as water.
- Extension Tube: Ø10 x 1000mm.
- Uses probes to extract engine oil through the dipstick tube.
- **Model No. S01168**
- List Price £149.95



£109.95 Exc. VAT
£131.94 Inc. VAT

8V Cordless Grease Gun

8V



- Lightweight versatile cordless grease gun, producing 3000psi.
- Ideal for on site jobs where space is at a premium.
- Suitable for 85g/3oz and 400g/14oz cartridges.
- Supplied with flexi and rigid delivery nozzles as well as a 400g cartridge adaptor.
- Kit contains an 8V 2Ah lithium-ion battery and mains charger.
- **Model No. CPG8V**
- List Price £103.95

£79.95 Exc. VAT
£95.94 Inc. VAT

8V 2Ah Lithium-ion Power Tool Battery for CPG8V

8V



- Battery pack for Model No. CPG8V 8V Cordless Grease Gun.
- **Model No. CPG8VBP**
- List Price £24.45

£19.95 Exc. VAT
£23.94 Inc. VAT

12L Oil Extractor

12L

Manual Discharge

- Mobile oil drainer designed to extract oil via the dipstick.
- 12L Capacity tank allows easy collection and safe disposal of waste oil.
- Fitted with wheels for manoeuvring around the workshop with ease, even when full.
- Designed for use in small workshops where clean, spill-free oil removal from vehicles is required. No need to lift the vehicle or to remove the sump plug. Probes insert into the dipstick port, allowing the oil to be sucked from the engine sump.
- Accessories Supplied: Rigid Probes; Ø5mm x 650mm, 8mm x 650mm, Semi-Rigid Probes; Ø6mm x 800mm, 8mm x 800mm, Probe suitable for VW Golf.
- Also suitable for Mercedes.
- **Model No. AK466D**
- List Price £899.95



£749.95 Exc. VAT
£899.94 Inc. VAT

**Syphon Hand Pump
For 5L to 25L Containers**

**NEW
Product**



- Composite pump with manual squeeze type, self-priming feature.
- Suitable for water, for oils and non-aggressive chemicals.
- Ideal for use on up to 25L containers.
- Suction tube length 385mm.
- Discharge tube length 540mm.
- Delivers approximately 7L/min.
- **Model No. TP76**
- List Price £5.95

£4.45 Exc. VAT
£5.34 Inc. VAT

**High Flow Syphon Pump with
Segmented Suction Pipe**

**NEW
Product**

High Flow



- Easy-to-use polyethylene manual pump with self-priming feature.
- Equipped with vent cap to stop discharge after use, and 120mm flexible corrugated discharge hose.
- Suitable for water, oils and non-aggressive chemicals.
- Segmented suction pipe for height adjustment and easy storage and transport.
- For use with various drums heights from 420mm, 530mm up to 850mm/205L.
- Delivers approximately 21L/min, transferring liquids quickly and easily.
- **Model No. TP782**
- List Price £32.95

£24.95 Exc. VAT
£29.94 Inc. VAT

**Gear Oil Pump
Drum Trolley**



- For use with Model No. TP67.
- **Model No. TP67DT**
- List Price £114.95

£84.95 Exc. VAT
£101.94 Inc. VAT

7.6L Oil/Fluid Drain Pan

7.6L



- Made from high-density Polyethylene with UV stabilisers.
- Features anti-splash lip that contains fluid when carrying or pouring.
- Large handles and enclosed pouring spout aid return of oil/fluid to recycling container.
- **Model No. DRP02**
- List Price £24.95

£15.95 Exc. VAT
£19.14 Inc. VAT

**15L Oil/Fluid Drain Pan &
Recycling Container
Wheeled**

15L



- Ensures safe and clean collection, transportation and temporary storage of waste oil.
- Features heavy-duty construction with wheeled undercarriage for easier transportation.
- Closed design for spill-free disposal.
- Stores flat or in upright position.
- **Model No. DRP44**
- List Price £47.95

£34.95 Exc. VAT
£41.94 Inc. VAT

**54L Wheeled Oil/Fluid
Drain & Recycling
Container**

54L



- Ensures safe and clean collection, transportation and temporary storage of waste oil.
- Features heavy-duty construction with wheeled undercarriage for easier transportation of full drainer.
- Includes four integral oil filter drain positions.
- Stores flat or in upright position.
- **Model No. DRP09**
- List Price £319.95

£239.95 Exc. VAT
£287.94 Inc. VAT

Spill Pallets with Hardcover



Model No. SJ1010 open, drums not included.



Model No. SJ1001



Model No. SJ1010

- Either side entry via sliding shutter.
- Tall headspace to accommodate drum pumps and accessories.
- Weathertight.
- Can be padlocked (not included).
- Can be bolted to the ground.
- Compatible with most chemicals.
- Model No. SJ1001 is pallet truck and forklift compatible, Model No. SJ1010 is forklift compatible only.

75+ KG
HEAVY ITEM
These items are heavy. Extra assistance must be provided at the delivery point to help safe delivery.

Model No.	Sump Capacity	Drum Capacity	Size (W x D x H)	List Price	Exc. VAT	Inc. VAT
SJ1001	250L	2	1565 x 995 x 2110mm	£1,595.00	£1,399.95	£1,679.94
SJ1010	485L	4	1565 x 1730 x 2110mm	£1,995.00	£1,799.95	£2,159.94

**IBC Spill Pallet with
Weathertight Hardcover**

**2500kg
Capacity**



- Clean, secure and weathertight storage.
- Double swing doors with 3-point locking mechanism.
- Door vents for air circulation.
- 2L In-platform drip tray.
- 100% Polyethylene.
- Roof designed for quick rainwater run-off to the rear.
- Ample headroom.
- Capacity: 1260L.
- Maximum load capacity: 2500kg.
- Easy to assemble, all fixings supplied.
- **Model No. SJ5101**
- List Price £2,995.00

75+ KG
HEAVY ITEM
This item is heavy. Extra assistance must be provided at the delivery point to help safe delivery.

£2,749.95 Exc. VAT
£3,299.94 Inc. VAT

These products are manufactured to order and, due to the size, are delivered direct from our factory to all areas within the UK Mainland. Additional carriage charges may apply for some areas of Devon/Cornwall, Scotland, Wales, Northern Ireland, Isle of Man, Isle of Wight, Jersey, Guernsey and other offshore islands due to remoteness of location.

14L Portable Parts Washer Bucket with Brush

14L

- Lightweight and easy to move around the garage or workshop.
- Great for parts cleaning with any non-corrosive, water-based cleaning solutions.
- Simple to use with any 14L bucket, such as Sealey Model No. BM16 (bucket not included).
- Ideal for degreasing and cleaning small parts and tools with the hard bristle brush.
- Unique channel drainage system to catch waste material and the variable speed pump sits in the bucket.
- **Model No. SM220**
- List Price £59.95



£46.95 Exc. VAT
£56.34 Inc. VAT

NEW Product

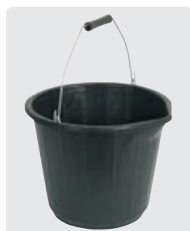

See page 148 for compatible bucket BM16.

1L 2-Stroke Petrol/Fuel Mixing Bottle

1L

- For accurately mixing fuel and oil ratios for 2-stroke engines.
- Markings at 25:1, 32:1, 40:1 and 50:1.
- **Model No. JMIX01**
- List Price £8.85



£5.95 Exc. VAT
£7.14 Inc. VAT

5L Oil Containers with Lid & Flexible Spout - Set of 5

5L

Package includes:

- JDL5 - 5L Oil Container with Black Lid & Flexible Spout
- JDL5R - 5L Oil Container with Red Lid & Flexible Spout
- JDL5B - 5L Oil Container with Blue Lid & Flexible Spout
- JDL5G - 5L Oil Container with Green Lid & Flexible Spout
- JDL5L - 5L Oil Container with Lime Lid & Flexible Spout
- **Model No. JDL5SET**
- List Price £99.95



£64.95 Exc. VAT
£77.94 Inc. VAT

Translucent Measuring Jugs

0.25L

0.5L

OR

1L

Model No. JT1000



- Translucent polypropylene.
- Easy-to-read scale for accurate measurement (±1%).

Model No.	Capacity	List Price	Exc. VAT	Inc. VAT
JT0250	0.25L	£5.95	£3.95	£4.74
JT0500	0.5L	£8.25	£5.95	£7.14
JT1000	1L	£10.45	£7.75	£9.30

1.5L Oil Inspection Syringe

1.5L

- Multipurpose syringe with Viton® seal, ideal for the transfer of oils/fluids to and from vehicle components such as gearboxes and differentials.
- Translucent body allows easy inspection of contents.
- Fluid Compatibility: AdBlue®, Antifreeze, Brake Fluid, Diesel, Oil, Water.
- **Model No. VS405**
- List Price £69.95



£44.95 Exc. VAT
£53.94 Inc. VAT

550ml Fluid Transfer/Inspection Syringe

- Multipurpose syringe with Viton® seals, ideal for the transfer of oils/fluids to and from vehicle components such as gearboxes and differentials.
- Dual feature allows fluid to be extracted on pull stroke and expelled on push stroke, for a fast and fluent transfer of fluid.
- Fluid Compatibility: AdBlue®, Antifreeze, Brake Fluid, Diesel, Oil, Water.
- **Model No. VS558**
- List Price £74.95



£37.95 Exc. VAT
£45.54 Inc. VAT

Heavy-Duty High Flow Lever Pump

HEAVY DUTY

High Flow

400ml per stroke

- Steel barrelled, self-priming lever pump.
- Supplied with 2" BSP adaptor and dip tube suitable for 50 to 205L drums.
- Suitable for oils, antifreeze, degreasers and other non-corrosive fluids.
- Supplied with two delivery nozzles, one standard and one with a filter.
- **Model No. TP6801**
- List Price £103.95



£79.95 Exc. VAT
£95.94 Inc. VAT

Battery Operated Jerry Can Pump

- Easily transfers fluid from 5, 10 and 20L jerry cans.
- Compatible for use with diesel and water.
- Fitted with auto-stop feature to prevent overfilling.
- Operated by an electric motor powered by 2 x AA batteries (not included).
- Flow Rate: 9L/min.
- Not suitable for use with petrol or kerosene.
- **Model No. TP80**
- List Price £39.95



£29.95 Exc. VAT
£35.94 Inc. VAT

Jerry Can Adaptors

- Suitable for converting standard fuel cans into portable fuel tanks for generators, engines and other equipment.
- Ideal for testing/running engines on alternative fuel sources.
- Features breather hole and bayonet style fitting to attach onto all Sealey metal fuel cans.
- Suitable for use with Ø8mm hose (not included).



Model No.	Type	List Price	Exc. VAT	Inc. VAT
JCA1	Single Tube	£17.95	£13.95	£16.74
JCA2	Double Tube	£20.95	£15.95	£19.14

20L Jerry Can

Unleaded

Siegen

NEW Product

- Manufactured from 0.8mm steel.
- Marked with UN Certification Number and Flammable Liquid to conform to UK HSE regulations.
- 20L Capacity with fuel resistant lining.
- Powder coated lined inner tank to prevent rusting from petrol, diesel, oil, water or alcohol.
- Leak-proof bayonet closure allows storage of the can in any position. Includes locking pin.
- Powder coated colour Green for unleaded fuel.
- **Model No. JCY20G**
- List Price £49.95



£31.95 Exc. VAT
£38.34 Inc. VAT

205L 12V & 230V Electric Drum Pump

12V or 230V

- Fitted with built-in fuse for protection, with a silenced motor keeping noise to a minimum.
- Telescopic suction tube features a stainless steel filter at the base of the tube.
- Convenient holder for storing the dispensing nozzle.
- Includes 230V mains adaptor and 12V battery clips allowing user to operate unit with whichever supply is available.
- Supplied with a 2" BSP adaptor, 2m hose and manual dispensing nozzle with spout.
- Suitable for diesel, water, AdBlue®, antifreeze, windshield fluid, mild detergents, agricultural chemicals and light oils.



£269.95 Exc. VAT
£323.94 Inc. VAT

• Model No. **TP6818**

• List Price £379.95

Portable Diesel/Fluid Transfer Pumps

12V OR 24V

- Flow Rate: 46L/min.
- 30 Minute duty cycle.
- Robust and compact units can be wall mounted.
- Electric pump with battery clips.
- Self-priming pump housed in a die-cast aluminium casing.
- Suitable for filling diesel vehicles 'in the field'.
- Supplied with 4m suction/delivery hose and manual delivery nozzle.
- Includes on/off switch, carry handle, hose clamps (x4), hose tails (x3), mounting plate, PTFE tape and suction hose filter.



Model No.	Voltage	List Price	Exc. VAT	Inc. VAT
TP96	12V	£399.95	£279.95	£335.94
TP9624	24V	£399.95	£279.95	£335.94

200L Portable Tanks 12V

200L 12V

- Manufactured from HDPE.
- Supplied with a 12V electric pump, 4m electric cable and clamps, and a 4m delivery hose with automatic nozzle.
- Can be safely secured and transported on an ATV, pick-up truck or van, using grooves for tie down straps and six handles for positioning.
- Supplied with lockable cover.
- Model No. ADB200T is not suitable for petrol or diesel.
- Model No. D200T is not suitable for petrol.
- Size (L x W x H): 1100 x 800 x 470mm.

Model No.	Type	List Price	Exc. VAT	Inc. VAT
ADB200T	AdBlue®	£759.95	£649.95	£779.94
D200T	Diesel	£749.95	£649.95	£779.94



AdBlue®
Model No. ADB200T



Diesel
Model No. D200T

55L Dispensing Tanks

AdBlue® Model No. DT55B



Diesel Model No. DT55G



Oil Model No. DT55R



- Manufactured from hard wearing and durable polyethylene.
- 55L Capacity suitable for the distribution of Diesel, Oil, AdBlue®, Water and Antifreeze dependent on pump supplied.
- Fitted with two roller wheels, hose holder and vent caps.
- Each tank features a 2" BSP thread and 4-point screw fittings enabling other pumps to be fitted as required.

BUY TANKS SEPARATELY

Model No.	Application	Colour	List Price	Exc. VAT	Inc. VAT
DT55B	AdBlue®	Blue	£379.95	£319.95	£383.94
DT55G	Diesel	Grey	£379.95	£319.95	£383.94
DT55R	Oil	Red	£379.95	£319.95	£383.94

Dispensing Tank Combos

Oil Model No. DT55RCOMBO1

AdBlue® Model No. DT55BCOMBO1



Diesel Model No. DT55GCOMBO1



OR BUY AS A COMPLETE KIT

Model No.	Kit Contents	List Price	Exc. VAT	Inc. VAT
DT55BCOMBO1	DT55B Tank & TP6607 AdBlue® Lever Pump	£489.95	£369.95	£443.94
DT55GCOMBO1	DT55G Tank & TP96 12V Diesel Pump Kit	£699.95	£399.95	£479.94
DT55RCOMBO1	DT55R Tank & TP54 Oil Rotary Pump	£424.95	£249.95	£299.94

Hook-and-Loop Shaped Sanding Blocks

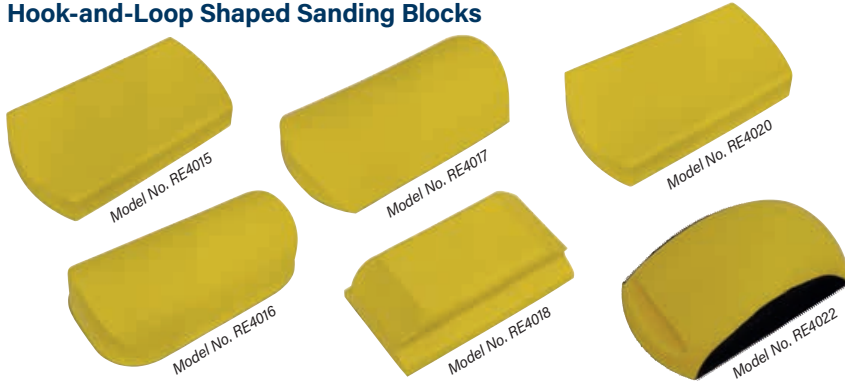

• Range of resilient sanding blocks for both small and large work areas.

Model No.	Type	Size	List Price	Exc. VAT	Inc. VAT
RE4015	Concave	90 x 155mm	£9.95	£5.95	£7.14
RE4016	Convex	85 x 155mm	£9.95	£5.95	£7.14
RE4017	Convex	90 x 160mm	£9.95	£5.95	£7.14
RE4018	Rectangle	125 x 70mm	£9.95	£5.95	£7.14
RE4020	Concave	90 x 155mm	£9.95	£5.95	£7.14
RE4022	Convex	90 x 150mm	£10.95	£7.45	£8.94

70 x 407mm Long Board Hook-and-Loop Sanding Block



- Resilient, long board sanding block with 70 x 407mm hook-and-loop surface.
- Designed for larger areas such as bonnets and flat panels.
- Can also be used with clip-on sanding sheets.
- **Model No. RE4021**
- List Price £37.95

£24.95 Exc. VAT
£29.94 Inc. VAT

90 x 135mm Sanding Block Flexible Tear Drop



- Flexible tear drop shaped sanding block.
- Designed for sanding various shapes, smaller surfaces and tight angles.
- 90 x 135mm Main surface.
- **Model No. RE4019**
- List Price £6.25

£4.95 Exc. VAT
£5.94 Inc. VAT

5 Tonne Pull Ram

5 Tonne



- Spring-return pull ram, suitable for use with manual or air powered hydraulic pumps.
- Supplied with two chain hooks.
- Stroke: 130mm.
- Ram Length Extended: 660mm.
- **Model No. RE91/05**
- List Price £124.95

£89.95 Exc. VAT
£107.94 Inc. VAT

10 Tonne Pull Ram

10 Tonne



- Spring-return pull ram, suitable for use with manual or air powered hydraulic pumps.
- Suitable for use with manual or air powered hydraulic pumps.
- Supplied with two chain hooks.
- Stroke: 150mm.
- Ram Length Extended: 500mm.
- **Model No. RE91/10**
- List Price £324.95

£259.95 Exc. VAT
£311.94 Inc. VAT

6pc Suction Clamp Set

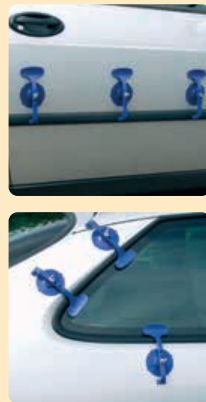

- A great time-saving tool set.
- Secures panel trims, decals, badges, window trims, rain and light sensors during preparation stages or while waiting for adhesives to set.
- Non-marking, composite construction with adjustable reach and clamp force.
- **Model No. RE006**
- List Price £53.95

£31.95 Exc. VAT
£38.34 Inc. VAT

10 Tonne Snap Push Ram with Pump & Hose Assembly

10 Tonne Snap



- Package Includes:**
- RE9710-02 - 10 Tonne Ram Assembly
 - RE9710-01 - 10 Tonne Pump & Hose Assembly
 - You may also refer to the individual Model No. for full specification at www.sealey.co.uk.
 - **Model No. RE9710-COMBO**
 - List Price £234.95

£189.95 Exc. VAT
£227.94 Inc. VAT

900kg Adjustable Vehicle Moving Dollies



- Heavy-duty steel frames suitable for supporting partly dismantled or badly damaged vehicles.
- Enables easy movement around workshop or bodyshop.
- Fitted with four castors.
- Model No. VMD001 has crutch supports adjustable for height and overall width.
- Model No. VMD002 has three types of height-adjustable and interchangeable supports, rubber support pads, shallow and deep crutches.

900kg
 ↑
 ADJUSTABLE
 HEIGHT
 ↓

Model No.	No. of Posts	Castors Type	List Price	Exc. VAT	Inc. VAT
VMD001	2	Ø90mm Metal	£174.95	£129.95	£155.94
VMD002	4	Ø200mm Nylon	£499.95	£359.95	£431.94

Adjustable Bumper Stand

NEW
 Product

- Stand rotates 90° and locks in place to best suit trim removal, plastic repairs, sanding, priming or painting.
- Fitted with clamps designed to hold the inside of the bumper without touching the painting surface.
- Arms adjusts from 115cm to 165cm to fit bumpers and other panels.
- Bumper stand includes foam-cushioned support arms to protect the items on the stand.
- Fitted with four castors, two with brakes for maximum manoeuvrability and safe positioning.
- **Model No. MK81**
- List Price £199.95



£159.95 Exc. VAT
£191.94 Inc. VAT

Alloy Wheel Repair/Painting Stand - 4-Wheel Capacity

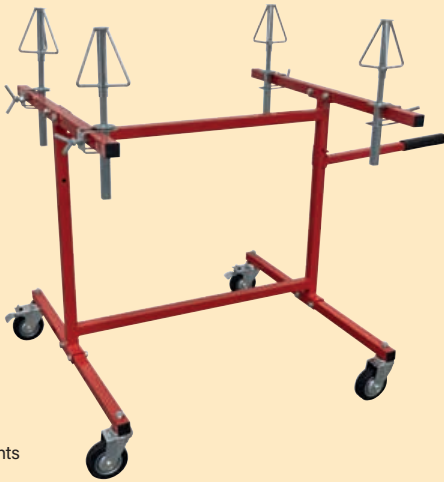

- Will take four alloy wheels and enable the user to rotate the wheels on cones so the wheels can be repaired or painted without the need to lift and reposition them.
- Both supporting bars and cones have adjustable heights in order to provide the most comfortable position to the user.
- Fitted with four castors, two with brakes for maximum manoeuvrability and safe positioning.
- **Model No. MK74**
- List Price £214.95

£169.95 Exc. VAT
£203.94 Inc. VAT

4-Level Bumper Rack

160kg



↑
 ADJUSTABLE
 HEIGHT
 ↓



- Double-sided rack for safe and tidy workshop storage of most vehicle bumpers.
- Heavy-duty construction ideal for use in bodyshops.
- Four pairs of height-adjustable support arms for maximum capacity and flexibility.
- Fitted with four castors, two with brake, for manoeuvrability and safe positioning.
- Safe Working Load: 160kg.
- **Model No. RE55**
- List Price £259.95

£189.95 Exc. VAT
£227.94 Inc. VAT

Parts Cart with Panel Train



- Suitable for windscreens, sheet metals, bonnets and doors, as well as other large items.
- Panel train includes eight foam-cushioned support arms to protect the items held within it.
- Fitted with four castors, two with brakes, for maximum manoeuvrability and safe positioning.
- Also includes Shelves (x3), 600mm Arms (x2), S-Shaped Hooks (x6).
- **Model No. MK75**
- List Price £359.95

£269.95 Exc. VAT
£323.94 Inc. VAT

Car Parts Trolley

90kg Capacity **HEAVY DUTY**



- Heavy-duty parts trolley for organised storage of car parts.
- Equipped with hanging rack for bumpers and exhaust pipes.
- Also includes a parts shelf, writing board, small parts basket and elastic straps.
- Fully manoeuvrable on four castor wheels, two with brakes.
- Maximum Capacity: 90kg.
- Size (W x D x H): 890 x 590 x 1700mm.
- **Model No. MK70**
- List Price £459.95



£319.95 Exc. VAT
£383.94 Inc. VAT

3pc Body Filler Applicator Set



- Manufactured from composite material.
- Suitable for the application of body filler.
- Widths: 100, 125, 150mm.
- **Model No. AK5225**
- List Price £3.95

£2.75 Exc. VAT
£3.30 Inc. VAT

4pc Body Filler Applicator Set



- Manufactured from stainless steel.
- Suitable for the application of body filler.
- Widths: 50, 80, 100, 120mm.
- **Model No. PA02**
- List Price £4.45

£3.45 Exc. VAT
£4.14 Inc. VAT

Aluminium Paint Measuring Sticks



- Ideal tool for measuring correct ratios as well as stirring.
- Double-side designs have two ratios.
- Stamped holes at top for convenient storage.

Model No.	Ratios	Size	List Price	Exc. VAT	Inc. VAT
PA04	2:1/4:1	350 x 30 x 2mm	£5.95	£4.45	£5.34
PA07	1:1/3:1	350 x 30 x 2mm	£5.95	£4.45	£5.34
PA08	5:1/5:3	350 x 30 x 2mm	£5.95	£4.45	£5.34

Model No. PA04

Lazy Tongs Riveter



- Supplied with five interchangeable nozzles covering 3.2, 4, 4.8, 6, 6.4mm rivets.
- Aluminium head with steel jaw case and Chrome Molybdenum jaws.
- Suitable for blind aluminium (up to 6mm), steel and stainless steel rivets.
- Overall Length: 800mm.
- **Model No. AK39902**
- List Price £53.95

£36.95 Exc. VAT
£44.34 Inc. VAT

2-in-1 Heavy-Duty Compact Riveter



- Suitable for hand and threaded nut rivets in aluminium, steel and stainless steel.
- 11 Nozzles to accept blind rivets up to 6.4mm and rivet nuts up to M10.
- Short arms provide effortless functionality and access to restricted spaces.
- Rivet Nut Sizes: M3 x 0.5, M4 x 0.7, M5 x 0.8, M6 x 1, M8 x 1.25, M10 x 1.5mm.
- Blind Rivet Sizes: 2.4mm(3/32"), 3.2mm(1/8"), 4mm(5/32"), 4.8mm(3/16"), 6.4mm(1/4").
- Supplied with nozzle spanner.
- Comfortable ergonomic grips.
- **Model No. AK3989**
- List Price £99.95

£67.95 Exc. VAT
£81.54 Inc. VAT

High Leverage Aviation Tin Snip Sets



- Drop-forged, Chrome Molybdenum, tempered steel blades with serrated jaws and.
- Self-opening, spring action handles with composite, contoured, colour-coded grips with safety catch.
- Model No. AK69072 are offset for easier cutting.

Model No.	Qty	List Price	Exc. VAT	Inc. VAT
AK69072	2pc	£46.95	£29.95	£35.94
AK69073	3pc	£53.95	£31.95	£38.34

Premier

LIFETIME GUARANTEE

Model No. AK69072

Model No. AK69073

75W Plastic Welding Repair Kit



- Heat gun body is lightweight and easy to operate with maximum control and accuracy provided by pistol grip design.
- Repairs cracked plastic parts such as car bumpers.
- Three different heat modes, high/medium/low.
- Overheating/overload protection.
- High brightness LED light to illuminate work area.
- Kit comprises of staples; 0.6mm outside corner (x50), 0.8mm inside corner (x50), 0.6mm flat (x50), 0.8mm flat (x50), 0.6mm wave (x50), 0.8mm wave (x50), soldering iron tip (x1), heat gun (x1).
- **Model No. SDL15**
- List Price £169.95

£124.95 Exc. VAT
£149.94 Inc. VAT

Air Suction Dent Puller

AIR Operated

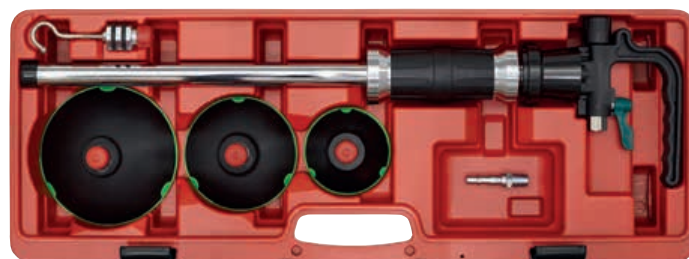

- Air activated suction pad keeps firm hold of panel while slide hammer is used to ease out dents and depressions without damage to the paint surface.
- Ideal for initial panel reshaping.
- Supplied with Ø75, 100 and 125mm suction pads and hook.
- **Model No. RE101**
- List Price £207.95

£159.95 Exc. VAT
£191.94 Inc. VAT

3pc Paintless Dent Repair Kit



- Time-saving kit.
- Heavyweight, heat treated, high quality steel components are carefully shaped and finished to allow the technician (with practice) to coax out all manner of dents and creases from behind the body panel, without the need to respray/refinish the painted surface.
- **Model No. RE104**
- List Price £29.95

£21.95 Exc. VAT
£26.34 Inc. VAT

Paintless Dent Repair Hand Shield



- Shaped to accept a range of paintless dent repair tools.
- Made from ABS plastic for increased strength and durability.
- Textured base provides a stable grip to vehicle tyres etc.
- Aids in preventing injuries caused during paintless dent repairs.
- **Model No. RE106**
- List Price £19.95

£13.95 Exc. VAT
£16.74 Inc. VAT

Paintless Dent Repair Tyre Support



- Designed for use with pushing tools, provides improved stability for wheel arch repairs.
- Reduces risk of damage to tyres and alloy wheels and injury to hands.
- Eyebolt can be adjusted to the required angle for the repair. Will accept up to approximately 35mm ball tip.
- Curved body maximises contact with tyre surface area for maximum support.
- Non-slip backing gives improved grip on the tyre.
- **Model No. RE107**
- List Price £24.95

£17.95 Exc. VAT
£21.54 Inc. VAT

Paintless Dent Repair Magnetic Head Blending Hammer



- Magnetic head allows quick and easy changing of tips.
- Supplied with blending and knocking down tips. Magnetic adaptors can be transferred to your favourite tips.
- Reversible handle allows length to be changed from 345mm to 415mm.
- Lightweight and strong carbon fibre shaft with an ergonomic handle.
- **Model No. RE108**
- List Price £49.95

£34.95 Exc. VAT
£41.94 Inc. VAT

Ø150mm Suction Dent Puller



- Strong suction will pull-out panel dents, move glass panels and aid handling.
- Suction releases simply by lifting the edge.
- **Model No. AK98**
- List Price £17.95

£10.95 Exc. VAT
£13.14 Inc. VAT

33pc Paintless Dent Repair Kit



- Contents: Lever Hooks, 45°-90° Flat Nose Bars, Flat Bar, 45° Flat Bar, Panel Bag, Window Wedge, Plastic Punch, Screw-on Plastic Rounded Tips, Door Jam, Curved Rounded Nose Hook Bar.
- **Model No. RE102**
- List Price £464.95

£349.95 Exc. VAT
£419.94 Inc. VAT

DUST-FREE SANDING KIT

- 35L
- 1000W
- Dust-Free
- 230V + Air



GSA05 features variable speed control and 360° exhaust muffler.

VARIABLE SPEED

RE4011 and RE4012 feature hook-and-loop foam pad and ergonomic soft grip.

Package includes:

- DFS35M - 35L Dust-Free Wet & Dry Industrial Vacuum Cleaner Plastic Drum Class M Filtration Self-Clean
- GSA05 - Ø150mm Dust-Free Air Palm Random Orbital Sander
- RE4011 - 70 x 120mm Dust-Free Sanding Block
- RE4012 - 70 x 198mm Dust-Free Sanding Block
- Please see www.sealey.co.uk for full specification of individual models.
- **Model No. DFSK01**
- List Price £819.95

£579.95 Exc. VAT
£695.94 Inc. VAT

AIR TOOLS



Wet & Dry

DFS35M FEATURES INDUSTRIAL WET & DRY VACUUM WITH M CLASS DUST EXTRACTION, CONTINUOUS OR SYNCHRONISED SUCTION AND SELF-CLEANING FILTER.

Magnetic Spray Gun Holder

Magnetic

- Heavy-duty 4.5kg capacity magnet will adhere to any ferrous surface.
- 50mm Wide steel hook with protective rubber coating.
- Suitable for use with most gravity fed spray guns.
- **Model No. MSH01**
- List Price £9.35



£6.95 Exc. VAT
£8.34 Inc. VAT

220mm Skeleton Type Manual Caulking Gun

- Suitable for 310ml cartridges up to 220mm length.
- **Model No. AK39**
- List Price £8.85



£4.95 Exc. VAT
£5.94 Inc. VAT

On-Gun Air Pressure Regulator/Gauge

- On-Gun Air Pressure Regulator/Gauge.
- Max. Pressure/Flow: 140psi/18cfm @ 90psi.
- Just one of a comprehensive range of quality spray gun accessories.
- **Model No. AR01**
- List Price £29.95



£20.95 Exc. VAT
£25.14 Inc. VAT

220mm One-Hand Caulking Gun

- Suitable for 310ml cartridges up to 220mm in length.
- Able to handle higher viscosity materials.
- Trigger handle eliminates wrist strain when operating for extended periods of time.
- Single hand design allows the user to maintain three points of contact when using a ladder.
- Hook end suitable for attaching to user's belt.
- **Model No. AK4804**
- List Price £18.95



£12.95 Exc. VAT
£15.54 Inc. VAT

Double Stand for Air Operated Panel Dryers



- Supports one or two air panel dryers (Model No's SDA01 or SDA03 below).
- **Model No. SDAST**
- List Price £207.95

£139.95 Exc. VAT
£167.94 Inc. VAT

10pc Mini Air Brush Kit Gravity/Suction Feed

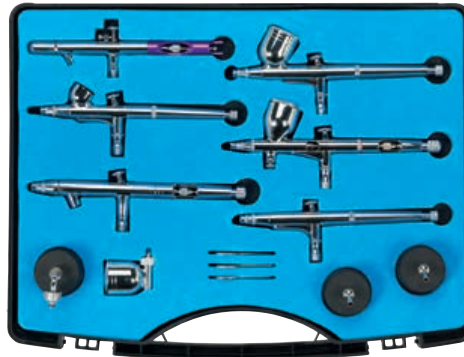

- Comprehensive mini air brush kit, including suction and gravity feed pots.
- Designed for detailed application.
- Double-action trigger providing precision control of paint flow.
- **Model No. AB936**
- List Price £169.95

£109.95 Exc. VAT
£131.94 Inc. VAT

Mini Air Brush Compressor



- Quiet running piston pump.
- Powered by a 122W electric motor.
- Suitable for most air brushes.
- Requires no lubrication and the air supply from the unit is oil-free.
- Supplied with an air filter regulator and pressure gauge.
- **Model No. AB900**
- List Price £157.45

£124.95 Exc. VAT
£149.94 Inc. VAT

Air Operated Panel Dryers with Adjustable Airflow



- Designed for drying water based paints.
- Operates on workshop air supply.
- Adjustable airflow.
- Ideal for localised or spot repair.
- Filter prevents airborne particles contaminating paint surface.
- Model No. SDA03 is suitable for composite panel drying.
- Handheld or mount on optional Double Support Stand Model No. SDAST (see above).

Model No.	List Price	Exc. VAT	Inc. VAT
SDA01	£93.95	£64.95	£77.94
SDA03	£43.95	£34.95	£41.94

Gravity Feed Spray Guns

Gravity Feed



- Features adjustable paint flow and fan width controls.
- Supplied with composite gravity feed pot.
- Suitable for use with water based paints.
- Alternative set-ups available separately.

Model No.	Set-Up	Alternative Set-Ups	List Price	Exc. VAT	Inc. VAT
SSG503	1.5mm	1.8, 2.2mm	£21.95	£16.95	£20.34
SSG502	1.8mm	1.5, 2.2mm	£21.95	£16.95	£20.34
SSG501	2.2mm	1.5, 1.8mm	£21.95	£16.95	£20.34

Portable Soda Blasting Gun



- Suitable for controlled removal of paint, mould, carbon, grease and rust.
- When adjusted correctly, is particularly useful in areas where less aggressive cleaning is required, such as around windows (without etching the glass) and even for stripping paint from wooden furniture.
- After blasting, the remaining surface will inhibit rust for up to six weeks.
- Adjustable nozzle allows control from narrow to wider stream.
- **Model No. PSB05**
- List Price £72.95

£49.95 Exc. VAT
£59.94 Inc. VAT

Bulk Feed Sandblasting Gun with Ø6mm Nozzle



- Suitable for cleaning larger areas.
- Accepts a variety of abrasives including sand, chilled iron grit and other proprietary types of beading.
- **Model No. SSG9**
- List Price £36.95

£24.95 Exc. VAT
£29.94 Inc. VAT

Air Recirculating Sandblasting Kit

Recirculating



- Suitable for use in the bodyshop.
- Feathering action makes it ideal for treating stone chips.
- Supplied with a set of four rubber nozzles and a 700g bottle of blasting grit.
- Replacement nozzles are available.
- **Model No. SG10E**
- List Price £54.95

£24.95 Exc. VAT
£29.94 Inc. VAT

Spray Gun Cleaning Tank 2 Gun Capacity

AIR Operated



- Suitable for containing water and detergent necessary for cleaning water based spray guns.
- Fully automatic operation - close lid to start and open lid to stop.
- Powerful and reliable piston pump system washes up to two guns simultaneously.
- **Model No. SM23/2**
- List Price £1,049.95

£899.95 Exc. VAT
£1,079.94 Inc. VAT



Shot Blasting Cabinet



Optional Stand available.
Order **Model No. SB972/ST**

- Steel cabinet with replaceable viewing screen and internal illumination.
- Fitted with shot blasting gun and suitable for proprietary brands of glass beads, silicone carbide, aluminium oxide and silica sand only.
- Overall Size (W x D x H): 760 x 510 x 715mm.
- **Model No. SB972**
- List Price £459.95

£359.95 Exc. VAT
£431.94 Inc. VAT

Shot Blasting Cabinet with Gun - Double Access

Double Doors



- Heavy-duty steel cabinet with toughened glass viewing screen and integral low voltage illumination.
- Two large side doors provide easy-access for bulkier items and includes Ø34mm dust extraction port for a clear view.
- Heavy gauntlets provide hand protection and cabinet is supplied with sand blasting gun with three spare ceramic nozzles.
- Includes pack of 10 screen covers.
- Overall Size (W x D x H): 695 x 580 x 625mm.
- **Model No. SB970**
- List Price £444.95

£339.95 Exc. VAT
£407.94 Inc. VAT

Shot Blasting Cabinet

Extraction Port



- Heavy-duty steel cabinet with toughened glass viewing screen and integral low voltage illumination.
- Large side door provides easy-access for bulkier items.
- Ø60mm Dust extraction port.
- Heavy gauntlets provide hand protection and cabinet is supplied with sand blasting gun, four ceramic nozzles and five visor covers.
- Suitable for glass beads, silicone carbide, aluminium oxide and shot blasting grit only.
- Capacity: 0.22m³.
- Overall Size (W x D x H): 890 x 570 x 1380mm.
- **Model No. SB973**
- List Price £619.95

£429.95 Exc. VAT
£515.94 Inc. VAT

THE SEALEY BUYING GUIDE TO MIG WELDERS



View our current range of MIG Welders here:

MIG welding involves a wire fed from a spool in the welder unit, which runs through a hose to a handheld torch. The wire performs two jobs; it supplies voltage to melt the metal being welded, and acts as a filler. The process offers high productivity, as the wire is continuously fed.

Gas is used to shield the weld from impurities which would cause the weld to become porous and weak. The gas is fed from a gas bottle mounted on the welder unit, up through the hose to a gas cup at the end of the torch. The gas can be easily blown away, particularly when working outdoors, resulting in poor quality welds. In recent years, Gasless MIG welders have become popular. They use a specialised flux coated wire to shield the weld, enabling them to be used outside.

WIRE

The wire performs two jobs; it supplies voltage to melt the metal being welded, and acts as a filler.

The main difference between flux-core and MIG welding is that flux-core welding does not require a shielding gas which makes it more portable. The self-shielding flux-cored wire provides the shielding gas when burned. This makes flux-core more suited to welding in windy conditions.



- FLUX-CORED WIRE**
- ✓ No gas bottle required.
 - ✓ Can be used outdoors.
 - ✓ Works through paint, rust and dirt.
 - ✗ Produces slag and spatter.
 - ✗ Cannot weld Aluminium.
 - ✗ More expensive.



- SOLID MIG WIRE**
- ✓ No slag, little spatter.
 - ✓ Handles thin metal well.
 - ✓ Produces cleaner welds.
 - ✗ Longer to set-up.
 - ✗ Needs clean surface.
 - ✗ Requires gas bottle.



TYPES OF GAS & INDUSTRIAL GAS SUPPLY



CO₂
CO₂ CARBON DIOXIDE
Used for mild steel.

CO₂/ARGON
CO₂/ARGON
A mixture of 20% Carbon Dioxide and 80% Argon which gives a smoother and cleaner weld than pure CO₂.

ARGON
ARGON
Used for aluminium.

THERE ARE THREE TYPES OF GAS USED:
If you plan to run your machine on gas, you need to consider how much welding you plan to do. Lower amperage machines tend to use small disposable or re-fillable bottles. If you plan to do a lot of welding, a large industrial gas bottle will be more economical. However, your welder will need to be converted to cater for the larger bottles. Larger amperage welders are designed for use with industrial gas bottles.

ENVIRONMENT & POWER SUPPLY

Location — **Gasless** — **Gas**

The first consideration when purchasing a MIG welder is where you intend to weld. If you plan to work outdoors, you need to purchase a MIG capable of gasless welding. Usually, these machines can be easily converted to run with or without gas.

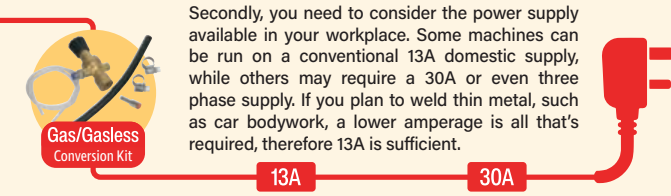

Secondly, you need to consider the power supply available in your workplace. Some machines can be run on a conventional 13A domestic supply, while others may require a 30A or even three phase supply. If you plan to weld thin metal, such as car bodywork, a lower amperage is all that's required, therefore 13A is sufficient.



TORCH & HOSE

EURO CONNECTION ENABLES QUICK AND SIMPLE PLUG CONNECTION TO WELDER.

EURO TORCH **NON LIVE TORCH**

Larger MIG welders include welding torches and hoses with a bayonet type connector. This allows the user to easily change between hoses/torches, which is particularly important if you frequently weld different types of metal i.e., mild steel to aluminium. Old school MIG welders have a permanently live torch, but most modern machines have a switch in the torch to turn on the voltage, feed the wire and turn on the gas supply. This is a safer and easier method and used in all SEALEY MIG welders.

DUTY CYCLE

The duty cycle of a welder reflects how long it can weld in a 10-minute period before it must cool down. For example, with a duty cycle of 60% at 100A the welder can be operated continuously for 6mins before it will need a 4min cool down period.

Generally, duty cycle isn't important for automotive repair work, as the amps tend to be low (higher duty cycle at lower amps). If you plan to carry out a lot of welding, the duty cycle is a very important consideration when comparing welders.

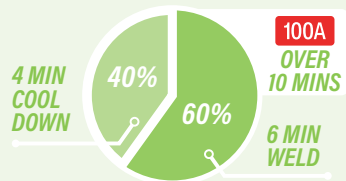

SAFETY

MIG welders create very hot temperatures and emit a very bright light, which can cause severe damage to both exposed skin and eyesight. Therefore, it is essential to wear the correct safety equipment.



- ✓ Welding Helmet
- ✓ Leather Welding Gauntlets
- ✓ Leather Welding Apron
- ✓ Spark Proof Welding Blanket
- ✓ Welding Curtain
- ✓ Fire Extinguishers
- ✓ Respiratory Protection

Please refer to our guide on PPE.

Auto Darkening Welding Helmets - Shade 9-13

Shade 9-13 Variable Grinding Function



Model No. PWH600



Model No. PWH601

- High quality variable shade 9-13 lens manufactured and tested to BS EN 379.
- Fully automatic switching from light to dark on striking arc.
- Features infinitely adjustable sensitivity and delay switches.
- Grinding function enables user to grind without removing mask.
- Deluxe contoured helmets approved to BS EN 175 which gives full neck protection.
- Comfortable headband and non-slip quick release ratchet mechanism.
- Suitable for MIG, TIG, arc and gas welding.

Model No.	List Price	Exc. VAT	Inc. VAT
PWH600	£79.95	£56.95	£68.34
PWH601	£79.95	£56.95	£68.34

Auto Darkening Welding Helmet Shade 11



Shade 11



- Complies to BS EN 379, BS EN 175 and DIN standards.
- Features automatic switching from light to dark on striking arc.
- Fitted with adjustable sensitivity and delay controls for switching light to dark.
- Deluxe contoured helmet with fully adjustable headband featuring front pad for added comfort.
- Suitable for MIG, TIG and arc welding.

£29.95	Exc. VAT
£35.94	Inc. VAT

Auto Darkening Welding Helmet with TH3 Powered Air Purifying Respirator (PAPR)

- PAPR (Powered Air-Purifying System) with Auto Darkening Welding Helmet with large viewing area.
- Lithium battery powered blower unit gives the user a cooling stream of air to their head and face for up to 8hr.
- The filter is designed to reduce or remove dust and particles but not vapours and gases.
- The kit meets performance class TH3 (Less than 0.2% inward leakage) according to EN 12941:1998.
- Adjustable airflow settings of 170 and 200L/min.
- Features a loud audible and visual alarm to alert user of low battery/low air.
- The welding helmet has adjustable shade control from 9-13.
- Fully automatic switching from light to dark on striking arc.
- Additional shades 5-8 for gas welding/cutting.
- Solar panel power supply.
- Features sensitivity and delay controls for switching light to dark.
- Contoured design helmet with adjustable headband for added comfort.
- Suitable for MIG, TIG, MMA/ARC welding, cutting and grinding.
- Complies with BS EN 379, BS EN 175, EN12941 and DIN standards.
- **Model No. PWH615**
- List Price £619.95



Shade 5-8 Switchable

Shade 9-13 Variable

£529.95	Exc. VAT
£635.94	Inc. VAT

Lined Leather Welding Gauntlets Pair



- Gauntlets offer superior protection from spatter and heat.
- Comfortable, durable and preferred by the professional welder.
- Conforms to BS EN 388 and BS EN 407.
- **Model No. SSP141**
- List Price £12.45

£8.95	Exc. VAT
£10.74	Inc. VAT

Professional MIG Welders

170A 190A 210A OR 250A



- Our professional range of MIGHTYMIG® welders all feature a heavy-duty high output transformer and forced air cooling to maximize duty cycle performance.
- MIGHTYMIG170, 190 and 210 are supplied with a high quality cool running Ergo 15.2 Euro torch thus ensuring a steadier weld bead, 2m earth cable, 1.4m of gas hose, twin gauged gas regulator, 0.6 and 0.8 tips. All three units are supplied set-up in gas mode, but can easily be switched to gasless mode by a simple change of polarity. Use in gasless mode will require the purchase of a spool of flux cored wire, a pack of 1mm tips and a 1mm wire feed roller.
- MIGHTYMIG250 is supplied with a high quality cool running BINZEL® MB25 Euro torch, 3m earth cable, 1.4m of gas hose, twin gauged gas regulator, 0.8 and 1mm tips. Set-up in the gas welding mode but can easily be switched to gasless. Use in gasless mode will require the purchase of a spool of flux cored wire.
- 3 Year Guarantee on the main units*.
- Lifetime guarantee on Transformer*.



Model No. MIGHTYMIG170



Model No. MIGHTYMIG250

Model No.	Welding Current	Duty Cycle	Wire Capacity	List Price	Exc. VAT	Inc. VAT
MIGHTYMIG170	40-170A	100% @ 55A, 60% @ 70A, 15% @ 140A	5kg	£599.95	£459.95	£551.94
MIGHTYMIG190	40-190A	100% @ 70A, 60% @ 90A, 15% @ 180A	5-15kg	£699.95	£559.95	£671.94
MIGHTYMIG210	45-210A	100% @ 80A, 60% @ 105A, 15% @ 210A	5-15kg	£739.95	£599.95	£719.94
MIGHTYMIG250	50-250A	100% @ 110A, 60% @ 140A, 15% @ 250A	5-15kg	£1,199.95	£899.95	£1,079.94

TIG/MMA Inverter Welders



- Lightweight, powerful and incredibly versatile.
- Inverters offer many advantages over traditional transformer type welders.
- These units use high quality state-of-the-art technology for the perfect weld.
- Fan-cooled DC power supply for TIG and arc welding applications.
- Suitable for welding steel, stainless steel, copper, nickel, titanium and their alloys.
- Outer cases manufactured from pressed steel with a powder coated finish for extra corrosion resistance.

Model No.	Power Output	Duty Cycle	Electrode Capacity	Absorbed Power	List Price	Exc. VAT	Inc. VAT
TIG130	20-130A	20% @ 130A, 60% @ 75A, 100% @ 60A	Ø1.6-3.2mm	4.25kW	£289.95	£219.95	£263.94
TIG160	20-160A	20% @ 160A, 60% @ 90A, 100% @ 70A	Ø1.6-4mm	5.1kW	£339.95	£279.95	£335.94

MMA Inverter Welders



- Lightweight, powerful and incredibly versatile, inverters offer many advantages over traditional transformer type welders.
- Inverters use state-of-the-art electronic components to produce fully portable power sources for arc welding.
- For example, Model No. MW160I will produce up to 160A at 20% duty cycle; a conventional 160A welder would have a duty cycle of around 10%.
- Manufactured from pressed steel with a powder coated finish for extra corrosion resistance, with ergonomically designed composite end for a stylish design and keeping weight below 7kg.
- Features a carry handle, ideal for mobile technicians.

Model No.	Welding Current	Duty Cycle	Electrode Capacity	List Price	Exc. VAT	Inc. VAT
MW160I	20-160A	100% @ 72A, 60% @ 92A, 20% @ 160A	Ø1.6-4mm	£199.95	£179.95	£215.94
MW180I	20-180A	100% @ 80A, 60% @ 104A, 20% @ 180A	Ø1.6-4mm	£239.95	£209.95	£251.94
MW200I	20-200A	100% @ 89A, 60% @ 115A, 20% @ 200A	Ø1.6-5mm	£269.95	£239.95	£287.94

200A MIG, TIG & MMA Inverter Welder with LCD Screen



- 3-in-1 welder - uses state-of-the-art inverter technology to achieve MIG/TIG/MMA (Arc).
- Inverter technology - offers many advantages over traditional transformer type welders, giving greater duty cycles and more power factor efficiency.
- Fan Cooled - DC power supply for MIG and TIG, suitable to weld steel, stainless steel, copper, nickel, titanium, and their alloys.
- Also suitable for MMA (Arc) welding - a variety of rods including rutile, basic and stainless from Ø1.6 to ø4mm.
- Fully functional - LCD front panel with easy to follow set-up.
- Up to four set-ups can be saved on the machine for fast loading.
- Switchable between MIG, TIG* or MMA* welding modes (*optional torches required).
- Supplied with 3m MIG torch, 3m 16mm² earth cable, both with 35-70 quick connectors, 4m gas hose and regulator.
- Model No. INVMIG200LCD
- List Price £999.95

£749.95 Exc. VAT
£899.94 Inc. VAT

200A MMA Inverter Welder & Battery Charger/Starter

200A MMA

NEW Product



- Three functions include a 160A MMA welder, 30A battery charger and a 200A start function.
- Unit can MMA weld a variety of rods including rutile, basic and stainless from Ø1.6mm up to Ø4mm.
- Features LED display, with thermal cut-out protection, anti-stick, arc force and hot start functions.
- Suitable for charging VRLA (Lead Acid), GEL, AGM/EFB and Leisure Batteries on 12 and 24V systems.
- Supplied with 1.6m 16mm² cable with electrode holder and a 1.4m 16mm² earth clamp and cable, 1m 200A charging clamps and 1.8m power cable.
- **Model No. MW160BC**
- List Price £199.95

£179.95 Exc. VAT
£215.94 Inc. VAT

Workshop Welding Curtains

1.8m Wide

OR

2.4m Wide

Model No. SSP993



- Amber welding screens manufactured to EN ISO 25980:2014.
- Suitable for use in workshops where the glare from welding and cutting may be a hazard to others.
- Curtain and frame supplied flat-packed.
- Assembles with ease.

Model No.	Frame Size	List Price	Exc. VAT	Inc. VAT
SSP992	1.8 x 1.75m	£209.95	£169.95	£203.94
SSP993	2.4 x 1.75m	£259.95	£209.95	£251.94

Oxy Acetylene Welding/Cutting Torch Set

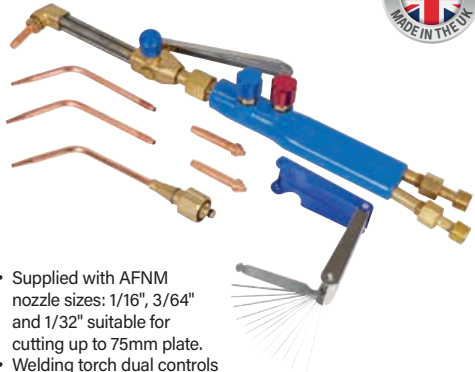

- Supplied with AFNM nozzle sizes: 1/16", 3/64" and 1/32" suitable for cutting up to 75mm plate.
- Welding torch dual controls allow for separate control over oxygen and acetylene flow creating different flames.
- Supplied with No's 2, 5 and 10 lightweight welding nozzles.
- Cleaning tool is designed for cleaning cutting nozzles.
- High quality lightweight copper cutting and welding nozzles.
- **Model No. SGA60**
- List Price £199.95

£164.95 Exc. VAT
£197.94 Inc. VAT

Oxy Acetylene Welding Hose Sets



Model No. WH10



- Pair of Ø10mm hoses fitted with 3/8" BSP swivel unions.
- Colour-coded red and blue hoses for easy identification of acetylene and oxygen.
- Conforms to BS EN 1256:2006 and BS EN 3821:2008.

Model No.	Length	List Price	Exc. VAT	Inc. VAT
WH05	5m	£61.95	£53.95	£64.74
WH10	10m	£99.95	£84.95	£101.94

Welding Chipping Hammer



- Pointed end for work where finer detail is required.
- Chisel face for a wider impact zone.
- Sprung handle absorbs impact and prevents kick back.
- **Model No. WCH02**
- List Price £5.95

£3.95 Exc. VAT
£4.74 Inc. VAT

Welding Bottle Trolleys



Model No. ST28S

Model No. ST28/B

- Lightweight tubular steel frames with large diameter wheels for easy transportation of heavy cylinders.

Model No.	Capacity	Cylinders	List Price	Exc. VAT	Inc. VAT
ST28S	1 Bottle	Ø250mm	£119.95	£99.95	£119.94
ST28/B	2 Bottle	Ø300mm	£149.95	£119.95	£143.94

Gas Cylinder Safety Cages

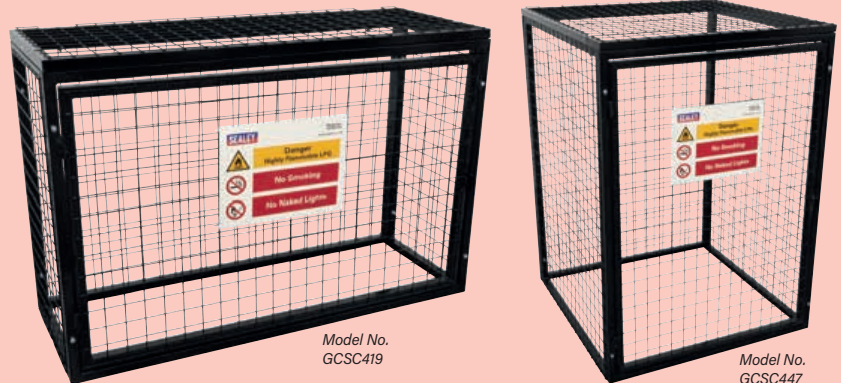

Model No. GCSC419

Model No. GCSC447

- Powder coated galvanised 30mm box frames with 50mm x 50mm x 3mm wire mesh.
- Hinged doors with hasp and staple for padlock (not provided).
- Pre-drilled fixing points for bolting to solid surface.
- Supplied flat-packed for easy self-assembly.
- Supplied with safety sign.

Model No.	Dimensions (W x D x H)	Capacity	List Price	Exc. VAT	Inc. VAT
GCSC419	1350 x 500 x 900mm	4 x 19kg	£319.95	£269.95	£323.94
GCSC447	1000 x 1000 x 1400mm	4 x 47kg	£369.95	£319.95	£383.94

COMPRESSOR BUYING GUIDE

OUTPUT

Each air tool has a cfm rating, which defines the amount of air required to power the tool in cubic feet per minute.

Determine the highest cfm rating of the air tools you intend to use. If you intend using more than one tool at the same time, you will need to add the ratings of both tools to calculate the total cfm rating.

A 50% safety margin then needs to be added e.g. a 4cfm tool would require a 6cfm output compressor.

Now you can look for the compressor that produces a high enough cfm output for your needs. When comparing models, ensure that you are reviewing the Free Air Delivery and not Air Displacement.

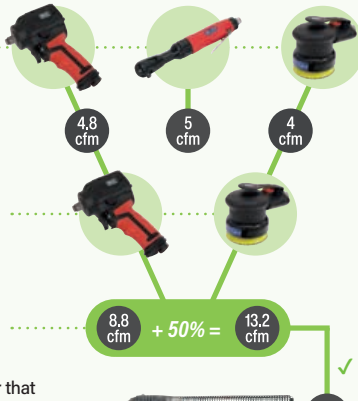

ELECTRIC OR PETROL DRIVEN

If you plan to use the compressor away from your premises, where there's no electrical supply, you will need to opt for a petrol version.



You will also need to check whether your power supply is adequate to run the compressor. Some larger compressors cannot be run from a 13A socket.



BELT DRIVE



DIRECT DRIVE

Compressors can be quite noisy.

Belt driven machines are quieter than direct drive versions, but some compressors have noise suppressing casings to reduce noise pollution. Screw compressors are even quieter. A low noise compressor is also an option, allowing use indoors and closer proximity to the unit, due to the increased exposure times to the noise levels being permitted.



SILENT COMPRESSOR

NOISE

OIL LUBRICATED OR OIL-FREE

Oil-free compressors need less maintenance compared to versions that require oil and therefore incur more regular servicing and increased running costs. Some applications will also need air that has no oil contaminants, so an oil-free compressor is essential for this. If running standard air power tools, then an oil lubricated compressor would not be an issue, and these can also have a longer life, due to less friction and wear within the unit.



WE STOCK A WIDE RANGE OF COMPRESSOR OIL FOR MOST COMPRESSORS.

AMOUNT OF USAGE

Compressors need to cool down between regeneration periods. Regeneration is when the pump replaces the air that has been used from the compressor's air tank. If you need to frequently/continuously run your compressor, such as on a production line or bodyshop, you may want to consider a screw compressor. These are designed for heavy-duty applications.



TANK SIZE

The size of the tank will determine how long you can use your air tools before needing to let the tank fill up again.



A longer job, such as sanding will require a larger compressor. Sanding with a 4cfm SA7/S will require a compressor with a minimum Free Air Delivery of 6cfm.

An air tool that requires a higher air output will drain the tank quicker than one that needs a lower air output, so the size you need depends on the job at hand and how long the task will take.

RECEIVER CAPACITY

HORSEPOWER

1.5hp 2hp 3hp 5.5hp 6.5hp

Air compressors typically have a horsepower rating between 1.5 and 6.5 and is a measure of the amount of work an engine can perform.

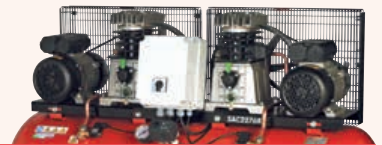

The higher the horsepower, the quicker the air is replaced in the air tank.

It is always worth looking at either the air accessories you already own or ones that would be great to accompany your new compressor.

This will allow less downtime between each job. It also allows the motor to work for shorter periods of time.

AIR HOSE REEL

Air hoses, or an air hose reel, will help the delivery of air to your tools. Different airline couplings may be required to allow the maximum potential from your air tools and to permit the use of multiple air lines from the one compressor.



AIR COUPLINGS



A regulator fitted in the airline to allow for a consistent pressure to be delivered to an air tool or a water trap, a lubricator or air filter may be worth investing in, depending on the application. Although, you must ensure that all accessories match the specifications of the compressor being purchased.



FILTER/REGULATOR/LUBRICATOR

AIR ACCESSORIES

Workshop Series Retractable PU Air Hose Reels

Auto Layering



- 6.5m
- 10m
- 12m
- OR
- 15m
- Ø6.5mm ID
- OR
- Ø8mm ID



Model No. SA814

- Double braided polyurethane hoses fitted with 1/4" BSP female inlets and 1/4" BSPT male outlets.
- Features auto-layering mechanism which distributes air hose evenly back into the reel housing preventing it from jamming.
- Supplied with mounting bracket and fixing kit for attachment onto walls or ceilings.

Model No.	Length	Hose Size (ID)	List Price	Exc. VAT	Inc. VAT
SA811	6.5m	Ø6.5mm	£81.95	£64.95	£77.94
SA812	12m	Ø6.5mm	£127.95	£99.95	£119.94
SA813	10m	Ø8mm	£141.95	£104.95	£125.94
SA814	15m	Ø8mm	£158.95	£119.95	£143.94

Retractable Air Hose Reels

Auto Layering

20m/10mm ID

OR

15m/12.5mm ID



Model No. SA94

- Solid brass internal spindle for added strength and durability.
- Self-layering system provides tangle-free operation.
- Auto-rewind mechanism.
- Positive latching at every full revolution of inner drum for hose length control.
- Reinforced braided PVC hose.
- Tough, durable design.
- Suitable for the professional workshop.
- Supplied with heavy-duty swivel mounted wall bracket and 2m inlet hose.

Model No.	Hose Length	Hose Size (ID/OD)	List Price	Exc. VAT	Inc. VAT
SA93	20m	Ø10/16mm	£284.95	£239.95	£287.94
SA94	15m	Ø12.5/18.5mm	£294.95	£244.95	£293.94

High-Visibility Hybrid Air Hoses with 1/4" BSP Unions

Silicone-Free Ø8mm ID OR Ø10mm ID



Model No. AHHC10



Model No. AHHC2038

- PVC and rubber blend offers more flexibility in temperatures as low as -40°C.
- High-visibility for added safety around the workplace.
- Manufactured in accordance with EN 5774.
- Features high grade TPR (Thermoplastic Rubber) inner tube and outer coating, offering lightweight, superior bend radius and durability.
- Fitted with 1/4" BSP female swivel unions.
- Silicone-free for use in bodysshops.

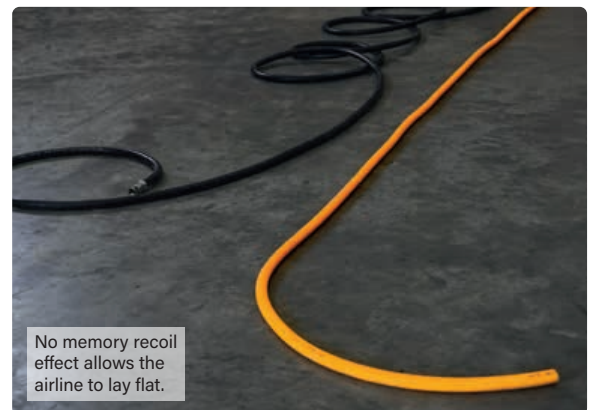

No memory recoil effect allows the airline to lay flat.

Model No.	Length	Bore	List Price	Exc. VAT	Inc. VAT
AHHC5	5m	Ø8mm	£22.95	£16.95	£20.34
AHHC10	10m	Ø8mm	£34.95	£26.95	£32.34
AHHC15	15m	Ø8mm	£47.95	£32.95	£39.54
AHHC20	20m	Ø8mm	£59.95	£42.95	£51.54
AHHC538	5m	Ø10mm	£25.95	£18.95	£22.74
AHHC1038	10m	Ø10mm	£40.95	£28.95	£34.74
AHHC1538	15m	Ø10mm	£54.95	£38.95	£46.74
AHHC2038	20m	Ø10mm	£69.95	£48.95	£58.74

SCAN TO EXPLORE OUR FULL RANGE OF INDIVIDUAL AIR HOSES



Couplings - Male Thread

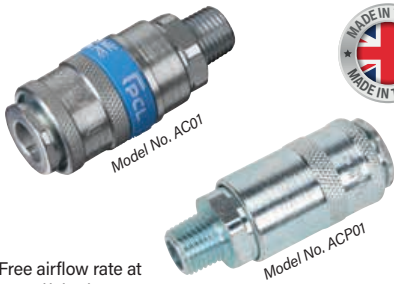

- Free airflow rate at 100psi(7bar): 35-43cfm(991-1218L/min).
- Ideal for workshop/engineering use with all types of wrenches, sanders and grinders.
- Model No. ACP01 is supplied in a pack of five.

Model No.	Thread Size	List Price	Exc. VAT	Inc. VAT
AC01	1/4"BSPT	£13.95	£9.45	£11.34
ACP01	1/4"BSPT	£64.95	£42.95	£51.54
AC62	3/8"BSPT	£17.95	£11.95	£14.34
AC63	1/2"BSPT	£17.95	£11.95	£14.34

Couplings - Female Thread

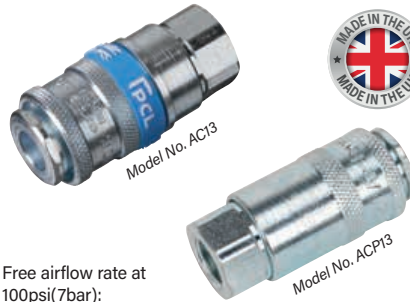

- Free airflow rate at 100psi(7bar): 35-43cfm(991-1218L/min).
- Ideal for workshop/engineering use with all types of wrenches, sanders and grinders.
- Model No. ACP13 is supplied in a pack of five.

Model No.	Thread Size	List Price	Exc. VAT	Inc. VAT
AC13	1/4"BSP	£13.95	£9.45	£11.34
ACP13	1/4"BSP	£64.95	£42.95	£51.54
AC64	3/8"BSP	£17.95	£11.95	£14.34
AC65	1/2"BSP	£17.95	£11.95	£14.34

Couplings - Tailpiece

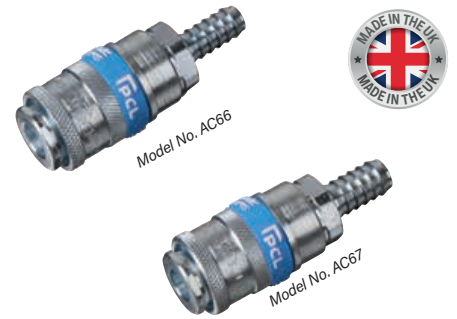

- Free airflow rate at 100psi(7bar): 35-43cfm(991-1218L/min).
- Ideal for workshop/engineering use with all types of wrenches, sanders and grinders.
- Adaptors will fit Vertex slim type coupling bodies.

Model No.	Hose Size	List Price	Exc.VAT	Inc.VAT
AC66	5/16"	£17.95	£11.95	£14.34
AC67	3/8"	£17.95	£11.95	£14.34

Screwed Adaptors Male Thread Packs of 5



- Free airflow rate at 100psi(7bar): 35-43cfm (991-1218L/min).
- Ideal for workshop/engineering use with all types of wrenches, sanders, and grinders.
- Adaptors will fit our airflow, vertex, safeflow, non-corrodible and our other standard coupling bodies.

Model No.	Thread Size	List Price	Exc. VAT	Inc. VAT
AC04	1/4"BSPT	£10.95	£6.95	£8.34
AC19	3/8"BSPT	£15.95	£10.45	£12.54
AC68	1/2"BSPT	£29.95	£19.95	£23.94

Screwed Adaptors Female Thread Packs of 5

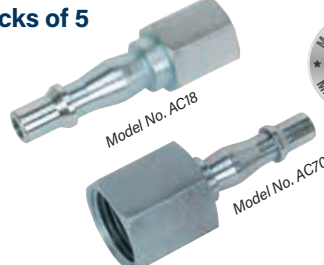

- Free airflow rate at 100psi(7bar): 35-43cfm (991-1218L/min).
- Ideal for workshop/engineering use with all types of wrenches, sanders, and grinders.
- Adaptors will fit our airflow, vertex, safeflow, non-corrodible and our other standard coupling bodies.

Model No.	Thread Size	List Price	Exc. VAT	Inc. VAT
AC18	1/4"BSP	£14.95	£9.95	£11.94
AC69	3/8"BSP	£24.95	£16.95	£20.34
AC70	1/2"BSP	£34.95	£22.95	£27.54

Adaptors - Tailpiece Packs of 5



- Free airflow rate at 100psi(7bar): 35-43cfm (991-1218L/min).
- Ideal for workshop/engineering use with all types of wrenches, sanders, and grinders.
- Adaptors will fit our airflow, vertex, safeflow, non-corrodible and our other standard coupling bodies.

Model No.	Hose Size	List Price	Exc. VAT	Inc. VAT
AC20	3/16"	£12.95	£8.95	£10.74
AC06	1/4"	£12.95	£8.95	£10.74
AC21	5/16"	£12.95	£8.95	£10.74
AC07	3/8"	£12.95	£8.95	£10.74
AC71	1/2"	£29.95	£19.95	£23.94

2pc 1/4"BSP Air Tool Coupling Kit



- Free airflow rate at 100psi(7bar): 35-43cfm(991-1218L/min).
- Kit comprising of female threaded coupling body and male threaded adaptor.
- Fitted with 1/4"BSP threads. Suitable for most air tool applications.
- Use in conjunction with whip/leader hose assembly, Model No. AH2R.
- **Model No. AC61**
- List Price £16.45

£10.95 Exc. VAT
£13.14 Inc. VAT

3pc 1/4"BSP Air Tool Coupling Kit



- Free airflow rate at 100psi(7bar): 35-43cfm(991-1218L/min).
- Kit comprising of male threaded coupling body together with male and female threaded adaptors.
- Fitted with 1/4"BSP threads.
- Suitable for most air tool applications.
- **Model No. AC60**
- List Price £17.95

£11.45 Exc. VAT
£13.74 Inc. VAT

Twin Coupling Bodies Y-Adaptor



- Ideal for workshop/engineering use with all types of wrenches, sanders and grinders.
- Adaptors will fit Vertex slim type coupling bodies.
- Free airflow rate at 100psi(7bar): 35-43cfm(991-1218L/min).
- **Model No. AC87**
- List Price £59.95

£39.95 Exc. VAT
£47.94 Inc. VAT

Belt Drive Air Compressors

100L 150L OR 200L



- Suitable for the professional workshop, these units are fitted with a genuine 3hp motor.
- Twin capacitors and a centrifugal switch aid trouble-free start-up on a 230V/13A supply (fitted with 3-pin plug).
- Pumps feature heavy-duty full cast cylinders, capped by alloy heads for improved heat dissipation and long-life.
- Heavy-duty drive guards protect belt and flywheel that is designed to force air over the pump to aid cooling.



Model No. SAC1103B



Model No. SAC1203B



Model No's SAC1153B and SAC1203B are heavy. Extra assistance must be provided at the delivery point to help safe delivery.

Model No.	Receiver Capacity	Motor Output	Minimum Rated Supply	Air Displacement	Max. Free Air Delivery	Max. Pressure	List Price	Exc. VAT	Inc. VAT
SAC1103B	100L	3hp	13A	13.4cfm(380L/min)	8.8cfm(249L/min)	145psi(10bar)	£779.95	£679.95	£815.94
SAC1153B	150L	3hp	13A	13.4cfm(380L/min)	8.8cfm(249L/min)	145psi(10bar)	£899.95	£819.95	£983.94
SAC1203B	200L	3hp	13A	13.4cfm(380L/min)	8.8cfm(249L/min)	145psi(10bar)	£999.95	£919.95	£1,103.94

Belt Drive Air Compressors

Cast Iron Cylinder Slow Running 3hp

100L 150L OR 200L

- Suitable for professional workshops these units are fitted with genuine 3hp motors.
- Twin capacitors and a centrifugal switch aid trouble-free start-up on a good 13A supply.
- All three models feature an easy-to-use control panel with two outlets, one regulated and one direct, along with heavy-duty pneumatic wheels with single front castor for easy manoeuvrability.
- All pumps feature heavy-duty full cast cylinders, capped by alloy heads for improved heat dissipation and long-life.
- Includes a drain valve for easy release of condensed water build-up in the tank.



Model No. SAC3103B



Model No. SAC3203B



These items are heavy. Extra assistance must be provided at the delivery point to help safe delivery.



Model No.	Receiver Capacity	Motor Output	Phase	Air Displacement	Max. Free Air Delivery	Max. Pressure	List Price	Exc. VAT	Inc. VAT
SAC3103B	100L	3hp	1ph	12.3cfm(347L/min)	9.5cfm(270L/min)	145psi(10bar)	£799.95	£729.95	£875.94
SAC3153B	150L	3hp	1ph	13.4cfm(347L/min)	10.9cfm(310L/min)	145psi(10bar)	£949.95	£869.95	£1,043.94
SAC3203B	200L	3hp	1ph	13.4cfm(380L/min)	10.9cfm(310L/min)	145psi(10bar)	£1,179.95	£999.95	£1,199.94

Belt Drive Air Compressors 3ph

Cast Iron Cylinder Slow Running

200L OR 270L



- Maximum Pressure: 145psi(10bar).
- Heavy-duty 3-phase units, suitable for professional workshops, these units are fitted with genuine 3hp, 5.5hp or 7.5hp motors.
- Twin capacitors and a centrifugal switch aid trouble free start up on a good 13A supply.
- Units give extra cfm pound for pound compared to standard 2-cylinder units.
- All pumps feature heavy-duty full cast cylinders, capped by alloy heads for improved heat dissipation and long-life.
- Each unit includes a drain valve for easy release of condensed water build-up in the tank.
- Model No. SAC3203B3PH has Heavy-duty pneumatic wheels with single front lockable castor for easy manoeuvrability.



Model No. SAC3203B3PH



Model No. SAC32775B



These items are heavy. Extra assistance must be provided at the delivery point to help safe delivery.



Model No.	Receiver Capacity	Motor Output	Air Displacement	Max. Free Air Delivery	List Price	Exc. VAT	Inc. VAT
SAC3203B3PH	200L	3hp	13.4cfm(380L/min)	10.9cfm(310L/min)	£1,149.95	£1,049.95	£1,259.94
SAC32055B	200L	5.5hp	20.7cfm(585L/min)	15.9cfm(450L/min)	£1,399.95	£1,249.95	£1,499.94
SAC32775B	270L	7.5hp	29.7cfm(840L/min)	26.2cfm(742L/min)	£2,149.95	£1,899.95	£2,279.94

Generation

These tools feature contoured, soft grip handles and housings which help reduce the effects of vibration and chill. The tools also include exhaust systems designed to reduce noise levels by baffling the noise or directing it away from the operator's environment. Generation Air Tools are backed with unrivalled, extensive aftersales care and 1 year guarantee*.

1/2" Sq Drive Composite Air Impact Wrench - Twin Hammer

1/2" Sq Drive Composite
Twin Hammer



- Fastening Torque: 737lb.ft(1000Nm).
 - Breakaway Torque: 1180lb.ft(1600Nm).
 - Twin hammer mechanism.
 - Lightweight and durable design.
 - Soft grip handle, with downward facing exhaust, reducing noise level and circulation of brake dust on wheel applications.
 - Fingertip control of power.
 - Direction via lever on rear of wrench.
- **Model No. GSA6006**
• List Price £129.95

£104.95 Exc. VAT
£125.94 Inc. VAT

Air Ratchet Wrenches

1/4" Sq Drive
3/8" Sq Drive
OR
1/2" Sq Drive



- Contoured handles to insulate user from chill and vibration.
- Finger operated trigger and textured grip allows added control, even with greasy hands.

Model No.	Drive	Length	List Price	Exc. VAT	Inc. VAT
GSA634	1/4" Sq	185mm	£51.95	£29.95	£35.94
GSA635	3/8" Sq	185mm	£51.95	£31.95	£38.34
GSA20	3/8" Sq	280mm	£54.95	£36.95	£44.34
GSA21	1/2" Sq	280mm	£54.95	£36.95	£44.34

Ø10mm Air Angle Drill with Keyless Chuck

Ø10mm



- 90° Angle is ideal for drilling in hard-to-reach areas.
 - Supplied with Ø10mm Jacobs keyless chuck for fast bit changes.
 - Directional, low noise air exhaust can be rotated 360°.
 - Contoured composite handle reduces effects of chill and vibration.
 - Fitted with safety trigger to prevent inadvertent operation.
- **Model No. GSA231**
• List Price £59.95

£36.95 Exc. VAT
£44.34 Inc. VAT

4pc Smart Eraser Air Tool Kit

Premier

3 YEAR GUARANTEE

Ø100mm



See page 90 for Ø100mm Wire Wheels.



- Complete kit for a variety of body preparation tasks.
 - Includes pinstripe removing pad, abrasive wheel and two wire wheels.
 - Air tool features two handles for maximum control during use.
 - Suitable for the professional workshop.
 - All pads/wheels available separately.
- **Model No. SA695**
• List Price £327.95

£249.95 Exc. VAT
£299.94 Inc. VAT

Air Die Grinders

Midi

- Soft handle grip for comfort and control.
- Adjustable exhaust outlet for control of exhaust direction.
- Trigger with safety catch to prevent accidental operation.
- Supplied with adjustment spanners.



Model No.	Type	List Price	Exc. VAT	Inc. VAT
GSA671	Standard	£43.95	£27.95	£33.54
GSA672	Long Reach	£59.95	£39.95	£47.94
GSA674	90° Angle	£54.95	£36.95	£44.34

42pc Air Angle Die Grinding/Sanding Kit

Ø50mm & Ø75mm

- Suitable for die grinding, sanding or panel preparation.
 - Generation Series 90° Air Angle Die Grinder (Model No. GSA674).
 - Safety trigger prevents inadvertent operation.
 - Contoured rubber handle for reducing vibration and added comfort.
 - 360° Rotating exhaust.
 - Includes a range of die grinding points, sanding rolls and Ø50/75mm preparation pads.
 - Replacement components readily available.
- **Model No. GSA674K**
• List Price £98.95



£69.95 Exc. VAT
£83.94 Inc. VAT

15pc 90° Angle Air Die Grinder Kit

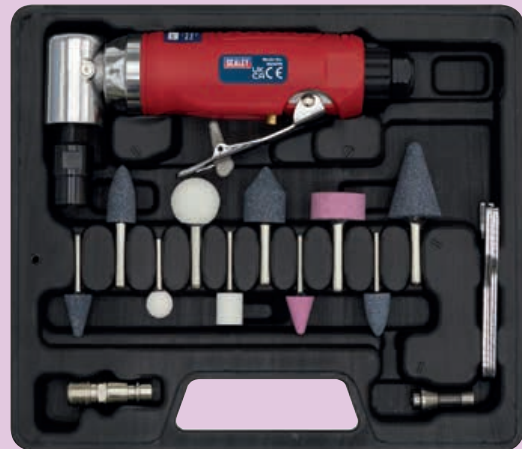

- Soft handle grip for comfort and control.
 - Adjustable exhaust outlet for control of exhaust direction.
 - Trigger with safety catch to prevent accidental operation.
 - Supplied with selection of popular grinding points, two spanners and storage case.
- **Model No. GSA675**
• List Price £62.45

£41.95 Exc. VAT
£50.34 Inc. VAT

Ø50mm Air Orbital Sander

Ø50mm



- Composite cover moulded around lightweight aluminium alloy housing reduces effects of chill on operator's hands and provides added control.
- Air motor with quality bearings for smooth and powerful operation.
- Fitted with safety release trigger control to prevent accidental operation.
- Exhaust outlet adjusts 360°.
- Free Speed: 15000rpm.
- Orbit Size: Ø3mm.
- Supplied with Ø50mm pad and installation spanner.
- **Model No. GSA70**
- List Price £54.95

£41.95 Exc. VAT
£50.34 Inc. VAT

Ø75mm Air Polisher

Ø75mm



- Textured grip and lightweight aluminium alloy housing provides comfort and control.
- Powerful air motor provides smooth operation under-load.
- Supplied with Ø75mm hook-and-loop pad and spanner.
- Use with Ø79mm buffing and polishing heads.
- **Model No. GSA722**
- List Price £56.95

£38.95 Exc. VAT
£46.74 Inc. VAT

Ø75mm Air Palm Orbital Sander

Ø75mm

VARIABLE SPEED



- Variable speed control lever for quick adjustment to suit workpiece.
- Supplied with hook-and-loop pad.
- **Model No. GSA003**
- List Price £60.95

£44.95 Exc. VAT
£53.94 Inc. VAT

Ø150mm Air Palm Random Orbital Sanders

Ø150mm

VARIABLE SPEED

Model No. GSA04



Model No. GSA05
Dust-Free

Model No. GSA06
Dust-Free Self-Contained

- Variable speed control lever for quick adjustment to suit workpiece.
- Features a 360° exhaust muffler to help reduce noise emission and redirect airflow away from operator.
- Supplied with Ø150mm hook-and-loop pad.
- Model No. GSA05 has a Dust-free outlet for use with centralised dust extraction systems.
- Model No. GSA06 Features a self-generated vacuum with hose and bag.

Model No.	Type	List Price	Exc. VAT	Inc. VAT
GSA04	Standard	£69.95	£54.95	£65.94
GSA05	Dust-Free	£76.95	£59.95	£71.94
GSA06	Dust-Free Self-Contained	£87.95	£64.95	£77.94

Air Hammer Kits

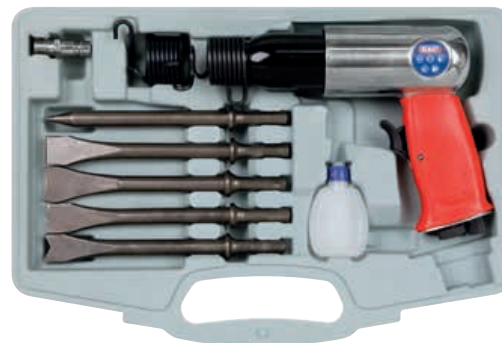

Model No. GSA11

MEDIUM STROKE
OR
LONG STROKE

- Handle exhaust reduces noise emission, and contoured, soft grip allows added comfort and control.
- Model No. GSA11 includes spring retainer, taper punch, long bladed panel cutter, weld buster, panel cutter and cold chisel.
- Model No. GSA12 includes spring retainers (x2), taper punch, special panel cutter, weld buster, panel cutter and cold chisel.

Model No.	Type	List Price	Exc. VAT	Inc. VAT
GSA12	Medium Stroke	£44.95	£31.95	£38.34
GSA11	Long Stroke	£54.95	£39.95	£47.94

Air Needle Scaler - Pistol Type

VARIABLE SPEED



- Generation series pistol type scaler suitable for cleaning heavy paint and rust scale from metal surfaces.
- Removable needle head allows use as a standard air hammer but requires additional chisel set and spring retainer (not included).
- Features variable speed trigger control.
- Replacement needle sets available.
- **Model No. SA50**
- List Price £74.95

£59.95 Exc. VAT
£71.94 Inc. VAT

Ø75mm Air Cut-Off Tools

Ø75mm



Model No. GSA25

Model No. GSA26

- Contoured handles insulate user from chill and vibration.
- Metal disc guard and rear air exhaust can be rotated 360°, giving operator added protection.
- Model No. GSA25 is ideal for cutting exhaust brackets.
- Model No. GSA26 Cutting disc is in-line with the handle for easier directional control.

Model No.	Type	List Price	Exc. VAT	Inc. VAT
GSA25	Standard	£39.95	£28.95	£34.74
GSA26	Straight	£59.95	£46.95	£56.34

Air/Hydraulic Riveters



Model No. GSA312

Model No. GSA314

HEAVY DUTY

- Suitable for aluminium, steel and stainless steel rivets.
- Trigger operated riveters with hardened steel jaw assembly and rivet shaft safety cap.
- Will handle heavy assembly work.
- Composite handles insulate user from chill and vibration.
- Model No. GSA312 supplied with four riveting nozzles and two spanners.
- Model No. GSA314 Ideal for heavy assembly work and is supplied with five riveting nozzles and two spanners.

Model No.	Rivet Sizes	List Price	Exc. VAT	Inc. VAT
GSA312	Up To 3/16"	£179.95	£89.95	£107.94
GSA314	Up To 1/4"	£249.95	£169.95	£203.94



10.8V 2Ah SV10.8 Series 3/8" Sq Drive Cordless Impact Wrench Kit



- Robust housing with soft grip to reduce vibration.
- Breakaway Torque: 220Nm(162lb.ft).
- No-Load Speed: 0-2700rpm.
- Integrated LED battery level indicator.
- Integrated LED worklight.
- Kit includes fast charge mains charger and 1 x 2Ah rechargeable lithium-ion battery.
- **Model No. CP108VCIW**
- List Price £74.95

3/8"
Sq Drive

220Nm
Torque

VARIABLE
SPEED

FAST
CHARGE

£57.95 Exc. VAT
£69.54 Inc. VAT

Body Only



- **Model No. CP108VCIWBO**
- List Price £41.95

£31.95 Exc. VAT
£38.34 Inc. VAT

10.8V 2Ah SV10.8 Series 1/4" Hex Drive Cordless Impact Driver Kit



- Variable speed gives more control during application.
- Maximum Torque: 120Nm.
- No-Load Speed: 0-2700rpm.
- Comfortable housing with soft grip to reduce vibration.
- Integrated LED battery level indicator.
- Integrated LED worklight.
- Kit includes fast charge mains charger and 1 x 2Ah rechargeable lithium-ion battery.
- **Model No. CP108VICID**
- List Price £72.95

For 1/4" Hex Bits

120Nm
Torque

VARIABLE
SPEED

FAST
CHARGE

£52.95 Exc. VAT
£63.54 Inc. VAT

Body Only



- **Model No. CP108VICIDBO**
- List Price £39.95

£28.95 Exc. VAT
£34.74 Inc. VAT

10.8V 2Ah SV10.8 Series Ø10mm Cordless Combi Drill Kit



- Two variable speeds and a locking function that gives more control during application.
- All metal gear construction for ultimate durability and performance to help you tackle the toughest of jobs.
- Maximum Torque: 28Nm with 21 Torque settings.
- No-Load Speed: 0-400/0-1300rpm.
- Comfortable housing with soft grip to reduce vibration.
- Integrated LED battery level indicator and LED worklight.
- Kit includes fast charge mains charger and 1 x 2Ah rechargeable lithium-ion battery.
- **Model No. CP108VDD**
- List Price £72.95

Ø10mm

28Nm
Torque

VARIABLE
SPEED

FAST
CHARGE

£59.95 Exc. VAT
£71.94 Inc. VAT

Body Only



- **Model No. CP108VDDBO**
- List Price £39.95

£29.95 Exc. VAT
£35.94 Inc. VAT

10.8V 2Ah SV10.8 Series 3/8" Sq Drive Cordless Ratchet Wrench Kit 45Nm



- Spindle locking that gives more control during application.
- Quick stopping function.
- Forward and reverse control.
- No-Load Speed: 0-300rpm.
- Maximum Torque: 45Nm(33lb.ft).
- Supplied with fast mains charger and 1 x 2Ah rechargeable lithium-ion battery.
- Robust housing with soft, comfortable grip.
- **Model No. CP108VCRW**
- List Price £87.95

3/8"
Sq Drive

45Nm
Torque

VARIABLE
SPEED

FAST
CHARGE

£67.95 Exc. VAT
£81.54 Inc. VAT

Body Only



- **Model No. CP108VCRWBO**
- List Price £54.95

£40.95 Exc. VAT
£49.14 Inc. VAT

10.8V 2Ah SV10.8 Series Ø75mm Cordless Polisher Kit



- Comfortable housing with soft grip to help reduce vibration.
- 2-Speed variable control trigger.
- No-Load Speed: 0-2600/0-7800rpm.
- Thread Size: M6.
- Kit includes fast charge mains charger and 1 x 2Ah rechargeable lithium-ion battery.
- **Model No. CP108VCP**
- List Price £75.95

Ø75mm

VARIABLE
SPEED

FAST
CHARGE

£59.95 Exc. VAT
£71.94 Inc. VAT

Body Only



- **Model No. CP108VCPBO**
- List Price £42.95

£29.95 Exc. VAT
£35.94 Inc. VAT

10.8V SV10.8 Series Lithium-ion Battery Packs



Model No.
CP108VBP

2Ah



Model No.
CP108VBP4

4Ah



Model No.	Description	List Price	Exc. VAT	Inc. VAT
CP108VBP	10.8V 2Ah Battery	£22.95	£17.95	£21.54
CP108VBP4	10.8V 4Ah Battery	£43.95	£33.95	£40.74

10.8V SV10.8 Series Fast Charge Lithium-ion Battery Chargers

Model No.
CP108VMC



Model No.
CP108VMC2

Model No.	Description	List Price	Exc. VAT	Inc. VAT
CP108VMC	Single Charger	£18.45	£13.95	£16.74
CP108VMC2	Dual Charger	£32.95	£22.95	£27.54

4 x 10.8V SV10.8 Series Cordless Combo Kit 2 Batteries



Package includes:

- CP108VDDBO - 10.8V SV10.8 Series Ø10mm Cordless Combi Drill - Body Only
- CP108VCRWBO - 10.8V SV10.8 Series 3/8" Sq Drive Cordless Ratchet Wrench Body Only
- CP108VCPBO - 10.8V SV10.8 Series Ø75mm Cordless Polisher - Body Only
- CP108VCIWBO - 10.8V SV10.8 Series 3/8" Sq Drive Cordless Impact Wrench Body Only
- CP108VBP - 10.8V 2Ah Lithium-ion Power Tool Battery for SV10.8 Series (x2)
- CP108VMC - 10.8V SV10.8 Series Fast Charge Lithium-ion Battery Charger
- Canvas Tool Storage Bag
- **Model No. CP108VCOMBO1**
- List Price £219.95

£159.95 Exc. VAT
£191.94 Inc. VAT

4 x 10.8V SV10.8 Series Cordless Combo Kit 2 Batteries



Package includes:

- CP108VDDBO - 10.8V SV10.8 Series Ø10mm Cordless Combi Drill - Body Only
- CP108VCRWBO - 10.8V SV10.8 Series 3/8" Sq Drive Cordless Ratchet Wrench Body Only
- CP108VICDBO - 10.8V SV10.8 Series 1/4" Hex Drive Cordless Impact Driver Body Only
- CP108VCIWBO - 10.8V SV10.8 Series 3/8" Sq Drive Cordless Impact Wrench Body Only
- CP108VBP - 10.8V 2Ah Lithium-ion Power Tool Battery for SV10.8 Series (x2)
- CP108VMC - 10.8V SV10.8 Series Fast Charge Lithium-ion Battery Charger
- Canvas Tool Storage Bag
- **Model No. CP108VCOMBO2**
- List Price £219.95

£159.95 Exc. VAT
£191.94 Inc. VAT

SV10.8 SERIES



The Sealey SV10.8 Series, powered by fast charging high output Lithium-ion batteries, designed to make everyday tasks quick and easy. These quality, stylish tools deliver outstanding performance and feature ergonomic housings with soft grips providing greater control and comfort.

SV12 SERIES

The Sealey SV12 Series offers a range of compact, powerful tools, ideal for use in tight spaces. Advanced Lithium-ion battery technology delivers more power and optimised tool run time for superior all-around performance. Ergonomic composite housings reduce vibration, providing enhanced operator comfort and control.

Scan to see our full range



12V SV12 Series Cordless Power Tool Kits



Storage Bag Included

Model No. CP1202KITB

Package includes:

- 1 x 12V SV12 Series Cordless Tool
- CP1200BP 12V 1.5Ah Lithium-ion Power Tool Battery (X2)
- CP1200BP3 12V 3Ah Lithium-ion Power Tool Battery
- CP1200MC 12V Battery Charger
- CP1200CB Canvas Tool Storage Bag

Model No.	Type	List Price	Exc. VAT	Inc. VAT
CP1202KITB	Ratchet Wrench	£161.95	£117.95	£141.54
CP1204KITB	Impact Wrench	£159.95	£115.95	£139.14
CP1205KITB	Polisher	£139.95	£107.95	£129.54

2 x 12V SV12 Series Cordless Power Tool Kits



Storage Bag Included

Model No. CP1200COMB08

Package includes:

- 2 x 12V SV12 Series Cordless Tool
- CP1200BP 12V 1.5Ah Lithium-ion Power Tool Battery
- CP1200BP4 12V 4Ah Lithium-ion Power Tool Battery
- CP1200MC 12V Battery Charger
- CP1200CB Canvas Tool Storage Bag

Model No.	Type	List Price	Exc. VAT	Inc. VAT
CP1200COMB06	Ø10mm Cordless Hammer Drill/Driver, 1/4"Hex Drive Cordless Impact Driver 80Nm	£199.95	£144.95	£173.94
CP1200COMB08	3/8"Sq Drive Cordless Impact Wrench 80Nm, 1/2"Sq Drive Cordless Ratchet Wrench 80Nm	£269.95	£197.95	£237.54

3 x 12V SV12 Series Cordless Power Tool Combo Kit 2 Batteries



Storage Bag Included

Package includes:

- CP1201 - 12V Ø10mm Cordless Hammer Drill/Driver - Body Only
- CP1205 - 12V Ø71mm Cordless Polisher - Body Only
- CP1210 - 12V Ø75mm Angle Grinder - Body Only
- CP1200BP - 12V 1.5Ah Lithium-ion Power Tool Battery
- CP1200BP3 - 12V 3Ah Lithium-ion Power Tool Battery
- CP1200MC - 12V Lithium-ion Battery Charger
- CP1200CB - Canvas Tool Storage Bag
- Model No. CP1200COMB07
- List Price £259.95

£192.95 Exc. VAT
£231.54 Inc. VAT

4 x 12V SV12 Series Cordless Power Tool Combo Kit 2 Batteries



Storage Bag Included

Package includes:

- CP1201 - 12V Ø10mm Hammer Drill/Driver - Body Only
- CP1202 - 12V 3/8"Sq Drive Ratchet Wrench - Body Only
- CP1203 - 12V 1/4"Hex Drive Impact Driver 80Nm - Body Only
- CP1204 - 12V 3/8"Sq Drive Impact Wrench 80Nm - Body Only
- CP1200BP - 12V 1.5Ah Lithium-ion Power Tool Battery
- CP1200BP4 - 12V 4Ah Lithium-ion Power Tool Battery
- CP1200MC - 12V Lithium-ion Battery Charger
- CP1200CB - Canvas Tool Storage Bag
- Model No. CP1200COMB0
- List Price £329.95

£239.95 Exc. VAT
£287.94 Inc. VAT

6 x 12V SV12 Series Cordless Power Tool Combo Kit 2 Batteries



Storage Bag Included

Package includes:

- CP1201 - 12V 10mm Hammer Drill/Driver - Body Only
- CP1202 - 12V 3/8"Sq Drive Ratchet Wrench - Body Only
- CP1203 - 12V 1/4"Hex Drive Impact Driver - Body Only
- CP1204 - 12V 3/8"Sq Drive Impact Wrench - Body Only
- CP1205 - 12V Ø71mm Polisher - Body Only
- CP1207 - 12V 49pc Rotary Tool & Engraver Kit - Body Only
- CP1200BP - 12V 1.5Ah Lithium-ion Power Tool Battery
- CP1200BP4 - 12V 4Ah Lithium-ion Power Tool Battery
- CP1200MC - 12V Lithium-ion Battery Charger
- CP1200CB - Canvas Tool Storage Bag
- Model No. CP1200COMB02
- List Price £399.95

£279.95 Exc. VAT
£335.94 Inc. VAT



20V SV20 Series Ø13mm Cordless Combi Drill/Driver Kits

- Ø2-13mm Keyless chuck.
- Three drill functions and 18 torque settings provide the control required to complete various tasks.
- Built-in LED worklight.
- Forward, reverse and trigger-lock.
- Supplied with belt hook for safer storage whilst not in use.
- Kits include mains charger and canvas tool storage bag.



Ø13mm

VARIABLE
SPEED

FAST
CHARGE

Storage Bag
Included

Model No. CP20VDDKIT1

Model No.	Batteries in Kit	List Price	Exc. VAT	Inc. VAT
CP20VDDKIT1	1 x 2Ah	£127.95	£108.95	£130.74
CP20VDDKIT	1 x 2Ah, 1 x 4Ah	£188.95	£160.95	£193.14

Body
Only

- Model No. CP20VDD
- List Price £54.95

£46.95 Exc. VAT
£56.34 Inc. VAT



20V 4Ah SV20 Series Cordless Impact Wrench Kits



Model No. CP20VXIWKIT1

- Breakaway torque of 1450Nm.
- Brushless motor which requires less maintenance than brushed equivalents.
- Durable composite housing with soft grip for added comfort.
- Variable speed trigger switch for easy control.
- 3-Speed control settings.
- All metal gear construction for ultimate durability and performance to help you tackle the toughest of jobs.
- Built-in LED worklight.
- Forward, reverse and trigger-lock.
- Fitted with electronic brake.
- Kits include mains charger and canvas tool storage bag.



Model No. CP20VXIWKIT

OUR MOST
POWERFUL
CORDLESS
WRENCH
EVER

Storage Bag
Included

Premier

3 YEAR
GUARANTEE

1/2"
Sq Drive

1450Nm
Torque

FAST
CHARGE

VARIABLE
SPEED

BRUSHLESS
MOTOR

Model No.	Batteries in Kit	List Price	Exc. VAT	Inc. VAT
CP20VXIWKIT	1 x 4Ah	£339.95	£288.95	£346.74
CP20VXIWKIT1	2 x 4Ah	£399.95	£339.95	£407.94

Body
Only

- Model No. CP20VXIW
- List Price £239.95

£203.95 Exc. VAT
£244.74 Inc. VAT



20V SV20 Series SDS Plus Cordless Rotary Hammer Drill Kits

- SDS Plus chuck.
- Two drilling functions, rotary and rotary with hammer.
- Built-in LED worklight.
- Forward, reverse and trigger-lock.
- Variable speed trigger for greater control.
- Kits include mains charger and canvas storage bag.



Storage Bag
Included

SDS
Plus

VARIABLE
SPEED

FAST
CHARGE

Model No. CP20VSDSKIT1

Model No.	Batteries in Kit	List Price	Exc. VAT	Inc. VAT
CP20VSDSKIT1	1 x 2Ah	£132.95	£112.95	£135.54
CP20VSDSKIT	1 x 2Ah, 1 x 4Ah	£193.95	£164.95	£197.94

Body
Only

- Model No. CP20VSDS
- List Price £59.95

£50.95 Exc. VAT
£61.14 Inc. VAT



20V SV20 Series Brushless Cordless Nut Riveter Kits

- Suitable for aluminium rivet nuts with a pulling force of up to 4000N.
- Brushless motor for improved performance.
- Three selectable power settings to help preserve the battery by only supplying the force required.
- Quick release mechanism which allows for speedy mandrel changes.
- LED battery level indicator.
- Supplied with seven sets of threaded mandrels from M3 to M12.
- Kits include mains charger and canvas tool storage bag.

Storage Bag
Included

BRUSHLESS
MOTOR

FAST
CHARGE

NEW
Products



Model No.
CP20VNRKIT1

Model No.	Batteries in Kit	List Price	Exc. VAT	Inc. VAT
CP20VNRKIT1	1 x 2Ah	£392.95	£334.95	£401.94
CP20VNRKIT	1 x 2Ah, 1 x 4Ah	£453.95	£384.95	£461.94

Body
Only

- Model No. CP20VNR
- List Price £319.95

£271.95 Exc. VAT
£326.34 Inc. VAT

NEW
Product





20V SV20 Series Ø125mm Cordless Orbital Palm Sander Kits

- 3-Speed settings gives control to complete various tasks.
- Features a self-contained dust extraction port with dust collection bag.
- Fitted with Ø125mm hook-and-loop backing pad and supplied with two sanding discs.
- Kits include mains charger and canvas tool storage bag.

Model No.	Batteries in Kit	List Price	Exc. VAT	Inc. VAT
CP20VOSKIT1	1 x 2Ah	£127.95	£108.95	£130.74
CP20VOSKIT	1 x 2Ah, 1 x 4Ah	£188.95	£160.95	£193.14



Ø125mm

FAST CHARGE

Storage Bag Included

Body Only



- Model No. CP20VOS
- List Price £54.95

£46.95 Exc. VAT

£56.34 Inc. VAT

20V 4Ah SV20 Series Ø125mm Cordless Orbital Polisher Kits

- Digital display and variable speed control from 2100-5000rpm.
- 15mm Orbit for greater polishing efficiency.
- Features a slide-button on/off switch allowing for a smooth comfortable main handle grip.
- Spindle lock for fast and easy pad changes.
- Double injection composite housing with rubber grip for added comfort.
- Supplied with Ø125mm backing pad.
- Kits include mains charger and canvas tool storage bag.



Storage Bag Included

Premier

3 YEAR GUARANTEE*

Ø125mm

VARIABLE SPEED

FAST CHARGE

Model No.	Batteries in Kit	List Price	Exc. VAT	Inc. VAT
CP20VOPKIT	1 x 4Ah	£213.95	£181.95	£218.34
CP20VOPKIT2	2 x 4Ah	£274.95	£233.95	£280.74

Body Only



- Model No. CP20VOP
- List Price £114.95

£97.95 Exc. VAT

£117.54 Inc. VAT

20V 4Ah SV20 Series Ø150mm Cordless Rotary Polisher Kits

- Digital display and variable speed control from 500-3000rpm.
- Features a slide-button on/off switch allowing for a smooth comfortable main handle grip.
- Spindle lock for fast and easy pad changes.
- Double injection composite housing with rubber grip for added comfort.
- Supplied with Ø150mm backing pad and side handle.
- Kits include mains charger and canvas tool storage bag.



Ø150mm

VARIABLE SPEED

FAST CHARGE

Storage Bag Included

Model No.	Batteries in Kit	List Price	Exc. VAT	Inc. VAT
CP20VRPKIT	1 x 4Ah	£198.95	£169.95	£203.94
CP20VRPKIT2	2 x 4Ah	£259.95	£220.95	£265.14

Body Only



- Model No. CP20VRP
- List Price £99.95

£84.95 Exc. VAT

£101.94 Inc. VAT

20V 4Ah SV20 Series Ø115mm Cordless Angle Grinder Kits

- Superbly balanced, lightweight and compact design.
- Heavy-duty alloy bevel gear head with aluminium gear casing.
- Spindle lock for quick disc changes and adjustable disc guard.
- Supplied with side handle and soft grip for added comfort and control.
- Motor Power: 700W.
- Free Speed: 10,000rpm.
- Kits include mains charger and canvas tool storage bag.
- Model No. CP20VAGBKIT includes CP20VCP - LED Light/USB Charge Port.



Ø115mm

FAST CHARGE

Storage Bag Included

Model No.	Batteries in Kit	List Price	Exc. VAT	Inc. VAT
CP20VAGBKIT1	1 x 4Ah	£166.95	£141.95	£170.34
CP20VAGBKIT	2 x 4Ah	£227.95	£193.95	£232.74

Model No. CP20VCP included with Model No. CP20VAGBKIT

Body Only



- Model No. CP20VAGB
- List Price £67.95

£57.95 Exc. VAT

£69.54 Inc. VAT

20V SV20 Series Cordless Oscillating Multi-Tool Kits

- Durable composite housing with soft grip for added comfort.
- One tool suitable for multiple tasks such as sanding, scraping and cutting various materials.
- Built-in LED worklight.
- Quick blade change system.
- Includes sanding paper, backing pad, plunge saw blade, segment saw blade and scraper.
- 6-Speed settings.
- Kits include mains charger and canvas tool storage bag.



VARIABLE SPEED

FAST CHARGE

Storage Bag Included

Model No.	Batteries in Kit	List Price	Exc. VAT	Inc. VAT
CP20VMTKIT1	1 x 2Ah	£127.95	£108.95	£130.74
CP20VMTKIT	1 x 2Ah, 1 x 4Ah	£188.95	£160.95	£193.14

Body Only



- Model No. CP20VMT
- List Price £54.95

£46.95 Exc. VAT

£56.34 Inc. VAT

20V 4Ah SV20 Series 3/8" Sq Drive Cordless Ratchet Wrench Kits - 60Nm

- Maximum Torque: 60Nm.
- No-Load Speed: 0-250rpm.
- Variable speed trigger for easy control.
- Forward and reverse rotation.
- Trigger-lock button.
- Fitted with electronic brake.
- Built-in LED work light for low visibility areas.
- Kits include mains charger and canvas tool storage bag.



Model No.
CP20VRWKIT

3/8"
Sq Drive

60Nm
Torque

VARIABLE
SPEED

FAST
CHARGE

Storage Bag
Included

Model No.	Batteries in Kit	List Price	Exc. VAT	Inc. VAT
CP20VRWKIT1	1 x 4Ah	£163.95	£139.95	£167.94
CP20VRWKIT	2 x 4Ah	£224.95	£190.95	£229.14

Body Only



- Model No. CP20VRW
- List Price £64.95

£54.95 Exc. VAT
£65.94 Inc. VAT

20V SV20 Series Cordless Hot Air Gun Kits

- Lightweight, cordless hot air gun with a maximum temperature of 550°C.
- Suitable for paint stripping, soft soldering, removing sticky labels and defrosting frozen pipes.
- Spring loaded, rotating end bezel for removing hot nozzles quickly and easily.
- Integrated belt hook.
- Built-in LED worklight.
- Supplied with fish tail nozzle, deflector nozzle and reduction nozzle.
- Kits include mains charger and canvas tool storage bag.



Model No.
CP20VHGKIT

FAST
CHARGE

Storage Bag
Included

Model No.	Batteries in Kit	List Price	Exc. VAT	Inc. VAT
CP20VHGKIT	1 x 2Ah	£132.95	£112.95	£135.54
CP20VHGKIT2	1 x 2Ah, 1 x 4Ah	£193.95	£164.95	£197.94

Body Only



- Model No. CP20VHG
- List Price £59.95

£50.95 Exc. VAT
£61.14 Inc. VAT

20V SV20 Series Cordless Reciprocating Saw Kits

- Powerful, lightweight cordless reciprocating saw suitable for cutting wood, board and soft metals.
- Built-in quick blade change system.
- Variable speed control trigger switch.
- Supplied with wood (6tpi) and metal (18tpi) cutting blades.
- 2-Stage operation switch for added safety.
- Kits include mains charger and canvas tool storage bag.



Model No.
CP20VRSKIT

Storage Bag
Included

VARIABLE
SPEED

FAST
CHARGE



Model No.	Batteries in Kit	List Price	Exc. VAT	Inc. VAT
CP20VRSKIT1	1 x 2Ah	£127.95	£108.95	£130.74
CP20VRSKIT	1 x 2Ah, 1 x 4Ah	£188.95	£160.95	£193.14

Body Only



- Model No. CP20VRS
- List Price £54.95

£46.95 Exc. VAT
£56.34 Inc. VAT

20V SV20 Series Ø150mm Cordless Circular Saw Kits

- Powerful, lightweight cordless circular saw suitable for cutting wood, board and soft metals.
- Durable composite housing with soft grip for added comfort.
- Tool-free adjustment of cutting angle, depth and width.
- Built-in laser guide for accurate cutting.
- Supplied with Ø150mm saw blade.
- 2-Stage operation switch for added safety.
- Kits include mains charger and canvas tool storage bag.



Model No. CP20VCSKIT

Ø150mm

FAST
CHARGE

Storage Bag
Included

Model No.	Batteries in Kit	List Price	Exc. VAT	Inc. VAT
CP20VCSKIT1	1 x 2Ah	£147.95	£125.95	£151.14
CP20VCSKIT	1 x 2Ah, 1 x 4Ah	£208.95	£177.95	£213.54

Body Only



- Model No. CP20VCS
- List Price £74.95

£63.95 Exc. VAT
£76.74 Inc. VAT

20V SV20 Series Cordless Jigsaw Kits

- Powerful, lightweight cordless jigsaw suitable for cutting wood, board, plastic and steel.
- Tool-free blade change system.
- Variable speed control trigger switch 0-2400spm.
- Features dust blow and extraction function, and parallel guide.
- Four pendulum settings.
- 2-Stage operation switch for added safety.
- Supplied with hex key and wood cutting blade.
- Kits include mains charger and canvas tool storage bag.



Model No.
CP20VJSKIT

VARIABLE
SPEED

FAST
CHARGE

Storage Bag
Included



Model No.	Batteries in Kit	List Price	Exc. VAT	Inc. VAT
CP20VJSKIT1	1 x 2Ah	£127.95	£108.95	£130.74
CP20VJSKIT	1 x 2Ah, 1 x 4Ah	£188.95	£160.95	£193.14

Body Only



- Model No. CP20VJS
- List Price £54.95

£46.95 Exc. VAT
£56.34 Inc. VAT

Storage Bag included with kits on pages 80-85, where stated.

Model No. CP1200CB



Storage Bag
Included



20V SV20 Series 18G Cordless Staple/Nail Gun Kits

- Drives up to 50mm 18G nails or 40mm 18G staples into wood, without compressed air or mains power supply.
- Features an adjustable drive depth wheel for accurate results.
- Selectable single or contact firing allows use for different applications.
- Two LED lights for use in low light areas.
- Quick and easy nail or staple loading system with low level indicator.
- Safety trigger device prevents accidental firing of nails or staples.
- Kits include mains charger and canvas tool storage bag.

Model No.	Batteries in Kit	List Price	Exc. VAT	Inc. VAT
CP20VNGKIT1	1 x 2Ah	£197.95	£167.95	£201.54
CP20VNGKIT	1 x 2Ah, 1 x 4Ah	£258.95	£219.95	£263.94



Body Only

- Model No. CP20VNG
- List Price £124.95

£105.95 Exc. VAT
£127.14 Inc. VAT



20V SV20 Series 650ml Cordless Handheld Vacuum Cleaner Kits

- Features soft comfortable grip and is convenient for use in the home, workshop or car.
- Removable collection chamber with easy release button to dispose of waste efficiently.
- Supplied with 4pc Accessory Pack; extension pipe, crevice nozzle, brush nozzle and floor brush with removable brush section.
- Kits include mains charger and canvas tool storage bag.

Model No.	Batteries in Kit	List Price	Exc. VAT	Inc. VAT
CP20VCVKIT1	1 x 2Ah	£116.95	£99.95	£119.94
CP20VCVKIT	1 x 2Ah, 1 x 4Ah	£177.95	£150.95	£181.14



Body Only

- Model No. CP20VCV
- List Price £43.95

£36.95 Exc. VAT
£44.34 Inc. VAT



20V 4Ah SV20 Series Cordless Wet & Dry Vacuum Kits

- Lightweight, portable and cordless making it convenient for use in the home, workshop or car, especially where mains power is not accessible.
- Other features include onboard accessory storage; separate battery housing and built-in blow function, which can be used for many applications.
- Supplied with brush head attachments (x2), 2m extendable hose, hose storage clips (x4), HEPA filter, dust and foam filters.
- Kits include mains charger and canvas tool storage bag.

Model No.	Batteries in Kit	List Price	Exc. VAT	Inc. VAT
CP20VWDVKIT1	1 x 4Ah	£141.95	£120.95	£145.14
CP20VWDVKIT	2 x 4Ah	£203.95	£172.95	£207.54



Body Only

- Model No. CP20VWDV
- List Price £63.95

£54.95 Exc. VAT
£65.94 Inc. VAT



20V 2Ah SV20 Series Cordless Glue Gun Kits

- Ready to use in 3 minutes.
- Cordless operation allows use anywhere in the workshop.
- Composite housing with soft grip for added comfort.
- Suitable for glue sticks between Ø10-12mm.
- On/off switch and trigger feed control.
- Kits include mains charger and canvas tool storage bag.

Model No.	Batteries in Kit	List Price	Exc. VAT	Inc. VAT
CP20VGGKIT1	1 x 2Ah	£107.95	£91.95	£110.34
CP20VGGKIT	2 x 2Ah	£142.95	£121.95	£146.34



Body Only

- Model No. CP20VGG
- List Price £34.95

£29.95 Exc. VAT
£35.94 Inc. VAT



20V SV20 Series 310ml Cordless Caulking Gun Kits

- Cordless 20V Caulking Gun with cartridge holder.
- 6-Speed variable settings.
- Flow rate from 0.7-11mm/s.
- Max. Dispensing force: 4500N.
- Suitable for 310ml cartridges.
- Composite housing with soft grip for added comfort.
- Kits include mains charger and canvas tool storage bag.

Model No.	Batteries in Kit	List Price	Exc. VAT	Inc. VAT
CP20VCGKIT1	1 x 2Ah	£172.95	£146.95	£176.34
CP20VCGKIT	1 x 2Ah, 1 x 4Ah	£233.95	£198.95	£238.74



Body Only

- Model No. CP20VCG
- List Price £99.95

£84.95 Exc. VAT
£101.94 Inc. VAT



20V SV20 Series Cordless 3-in-1 Garden Tool Kits

- Ergonomic design and lock-in function make it comfortable and easy-to-use.
- Three tool-less interchangeable functions.
- Grass shearing blade cutting width 90mm.
- Hedge trimmer blade for light trimming, cutting length 200mm.
- Raker length 100mm.
- Kits include mains charger and canvas tool storage bag.

Model No.	Batteries in Kit	List Price	Exc. VAT	Inc. VAT
CP20VGT3KIT1	1 x 2Ah	£109.95	£92.95	£111.54
CP20VGT3KIT	1 x 2Ah, 1 x 4Ah	£174.95	£148.95	£178.74



Body Only

- Model No. CP20VGT3
- List Price £39.95

£33.95 Exc. VAT
£40.74 Inc. VAT



20V SV20 Series Cordless Leaf Blower Kits

- Extremely powerful garden leaf blower makes gardening easy, clean and effective.
- Ideal for removing leaves and waste from driveways, patios and small gardens.
- Kits include mains charger and canvas tool storage bag.

Model No.	Batteries in Kit	List Price	Exc. VAT	Inc. VAT
CB20VCOMBO2	1 x 2Ah	£91.95	£77.95	£93.54
CB20VCOMBO4	1 x 4Ah	£119.95	£101.95	£122.34



Body Only

- Model No. CB20V
- List Price £42.95

£36.95 Exc. VAT
£44.34 Inc. VAT



20V SV20 Series Cordless Hedge Trimmer Kits

- Blade tip and blade head protector fitted for added user safety.
- Rear handle features a soft grip and swivel feature which can be adjusted through 3-positions, making it easier to get to the desired angle.
- Kits include mains charger and canvas tool storage bag.

Model No.	Batteries in Kit	List Price	Exc. VAT	Inc. VAT
CHT20VCOMBO2	1 x 2Ah	£111.95	£94.95	£113.94
CHT20VCOMBO4	1 x 4Ah	£139.95	£118.95	£142.74



Body Only

- Model No. CHT20V
- List Price £64.95

£54.95 Exc. VAT
£65.94 Inc. VAT



20V SV20 Series Cordless Strimmer Kits

- Fully adjustable in height and cutting angles.
- Head can be adjusted vertically between 0°-50° (four settings available).
- Head can also be rotated between 0°-90° both ways for applications such as lawn edge cutting.
- Kits include mains charger and canvas tool storage bag.

Model No.	Batteries in Kit	List Price	Exc. VAT	Inc. VAT
CS20VCOMBO2	1 x 2Ah	£99.95	£84.95	£101.94
CS20VCOMBO4	1 x 4Ah	£129.95	£110.95	£133.14



Comes with 10 x plastic blades. For replacements order Model No. CS20VB

Body Only

- Model No. CS20V
- List Price £54.95

£46.95 Exc. VAT
£56.34 Inc. VAT



20V 2Ah SV20 Series Cordless Pruning Shears Kits

- Brushless motor.
- Cuts through branches up to Ø25mm.
- Additional safety switch for extra protection.
- Power assisted pruning shears make pruning stems and branches quick and easy.
- Additional safety switch for extra protection.
- Kits include mains charger and canvas tool storage bag.

Model No.	Batteries in Kit	List Price	Exc. VAT	Inc. VAT
CP20VPSKIT1	1 x 2Ah	£179.95	£152.95	£183.54
CP20VPSKIT	2 x 2Ah	£214.95	£182.95	£219.54



BRUSHLESS MOTOR

FAST CHARGE

Storage Bag Included

Body Only

- Model No. CP20VPS
- List Price £114.95

£96.95 Exc. VAT
£116.34 Inc. VAT



Storage Bag included with kits on pages 80-85, where stated.

Model No. CP1200CB



Storage Bag Included

20V SV20 Series Cordless Pressure Washer Kits

- 6-Function nozzles, selected by turning spray head.
- 120L/hr Flow rate with a working pressure of 22bar.
- Ideal for cleaning muddy bikes and sports equipment, as well as gutters, conservatory roofs and other hard-to-reach places.
- 6m Water intake hose with float and filter can draw water from any remote source.
- Kits include soap pot, mains charger and canvas tool storage bag.

Storage Bag Included 120L/hr **FAST CHARGE**

Model No. CP20VPWKIT1



Body Only

- Model No. CP20VPW
- List Price £94.95

£80.95 Exc. VAT
£97.14 Inc. VAT

Model No.	Batteries in Kit	List Price	Exc. VAT	Inc. VAT
CP20VPWKIT1	1 x 2Ah	£167.95	£142.95	£171.54
CP20VPWKIT	1 x 2Ah, 1 x 4Ah	£228.95	£194.95	£233.94

20V SV20 Series Lithium-ion Power Tool Batteries



Model No. CP20VBP2 **2Ah**

Model No. CP20VBP4 **4Ah**

Model No. CP20VBP6 **6Ah**

Model No.	Power	Charge Time	List Price	Exc. VAT	Inc. VAT
CP20VBP2	2Ah	45mins	£39.95	£33.95	£40.74
CP20VBP4	4Ah	90mins	£69.95	£59.95	£71.94
CP20VBP6	6Ah	130mins	£89.95	£76.95	£92.34

20V SV20 Series Lithium-ion Battery Chargers



Model No. CP20VMC

Model No. CP20VMC2

Model No.	Charger Type	List Price	Exc. VAT	Inc. VAT
CP20VMC	Single	£19.95	£16.95	£20.34
CP20VMC2	Dual	£34.95	£29.95	£35.94

SV20 SERIES

40+ TOOLS

SEE PAGES
81-85



POWERFUL PERFORMANCE

The SV20 series is our most powerful One-Battery range - highly suited to heavy-duty tasks. High outputs are achieved without compromising on operating time. With the option of two batteries, our kits ensure you can keep working while you recharge.

VERSATILITY

With a variety of tool bodies, single or twin chargers and a choice of lithium-ion batteries, the SV20 series provides the most versatile way to build your own cordless tool kit over time.

MOBILITY

Our cordless tools offer greater manoeuvrability around your workspace, whilst design features ensure they are comfortable and easy-to-use. For protection and portability, our kits are supplied with a handy storage bag.



Brushless motors offer high efficiency, resulting in a better runtime, improved performance and greater durability. They are also quieter and lighter and require less maintenance than brushed equivalents.

The series provides a choice of lithium batteries ranging from 2Ah, for faster charge, up to 6Ah for longer-lasting runtimes.

For advice on selecting the right battery, scan the QR code.



Ø215mm Handheld Drywall Electric Sander 1050W

Ø215mm 1050W **VARIABLE SPEED**



- Variable speed control Drywall Sander with 1050W motor.
- Spring loaded sanding head with Ø215mm sanding pad.
- Suction regulator in sanding head.
- Fitted with 4m mains cable.
- Supplied with Ø225mm sanding discs (x8), flexible pipe for dust extraction, dust bag and side handle.
- **Model No. DWS215**
- List Price £114.95

£99.95 Exc. VAT
£119.94 Inc. VAT

Ø215mm Long Reach Drywall Electric Sander 600W

Ø215mm 600W **VARIABLE SPEED**

- Variable speed control extendable long reach drywall sander with 600W motor.
- Spring loaded sanding head with Ø215mm sanding pad for easy use on a large surface area.
- 0°-90° Pivoting head.
- Two pitch points allowing the user to work easily between 700-1000mm above head height.
- Fully extendable to 1650mm.
- To be used in conjunction with an extractor, see website for all models available.
- Fitted with 4m mains cable.
- Supplied with Ø225mm sanding disc and flexible pipe with connector for dust extraction.

- **Model No. TDWS600**
- List Price £169.95



£129.95 Exc. VAT
£155.94 Inc. VAT

Ø150mm Brushless Electric Palm Sander 350W

Ø150mm 350W **VARIABLE SPEED**



- Ergonomic and compact lightweight sander.
- Brushless motor with constant speed control even whilst under load.
- 7-Stage variable speed control.
- Digital display.
- Supplied with dust-free Ø150mm backing pad, four sanding discs and dust extraction hose.
- **Model No. DAS150PS**
- List Price £233.95



£199.95 Exc. VAT
£239.94 Inc. VAT

Ø150mm Dual Action Sander/Polisher 600W

Ø150mm Dual Action 600W **VARIABLE SPEED**

- Lightweight, compact sander with soft start.
- Variable speed control from 1500-6800rpm.
- Dual action orbit of Ø8mm helps cover more surface during use.
- On/off slide switch.
- Soft grip for added comfort.
- Supplied with 1.9m mains cable.
- Also suitable for polishing when fitted with Model No. PTC115VA516 Backing Pad (not included).
- **Model No. DAS149**
- List Price £124.95



£89.95 Exc. VAT
£107.94 Inc. VAT

Ø170mm Sander/Polisher 1300W

Ø170mm 1300W

VARIABLE SPEED

- 6-Position electronic variable speed control.
- Speed Range: 1400-3000rpm.
- Supplied with side handle, backing pad and disc spanner.
- **Model No. MS900PS**
- List Price £124.95



£84.95 Exc. VAT
£101.94 Inc. VAT

Ø180mm Sander/Polisher 1400W

Ø180mm 1400W

VARIABLE SPEED

- Soft start, constant power motor ideal for polishing or sanding.
- Variable speed control from 600-3000rpm, in 7-speed settings.
- Alloy gear head with protective rubber casing.
- Spindle lock for fast and easy pad/foam head changes.
- Supplied with over the top 'D' Handle, backing pad and bonnet.
- **Model No. MS925PS**
- List Price £139.95



£89.95 Exc. VAT
£107.94 Inc. VAT

Quick Change Oscillating Multi-Tool 300W

300W **VARIABLE SPEED**

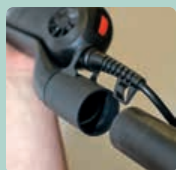

- Suitable for multiple tasks such as sanding, scraping and cutting various materials.
- Variable speed with 300W motor and sealed bearings.
- Quick release lever makes changing blades fast and simple.
- Includes four sanding discs, backing pad, cutting blade, scraper blade and dust extraction pipe.
- Supplied in a handy storage case.
- Full range of additional quick change accessories available.
- **Model No. SMT300Q**
- List Price £69.95

£41.95 Exc. VAT
£50.34 Inc. VAT

Spot Polisher Kit 600W

Premier

3 YEAR GUARANTEE

- Rotary spot polisher kit.
- Ergonomic slim body design.
- 6-Stage variable speed control from 700-2500rpm.
- Spindle lock for easy pad and shaft changes.
- Soft start for greater control.
- Fitted with 5m mains cable.
- Supplied with a selection of polishing pads, side handle and spare brushes.
- **Model No. SPK600**
- List Price £199.95



£139.95 Exc. VAT
£167.94 Inc. VAT

3.7V Vacuum Drill Dust Extractor



- Vacuum holds unit to the wall for easy drilling.
- Suitable for drill bits up to Ø12mm.
- Features a horizontal and vertical spirit level for accurate positioning.
- Laser light on the bottom for accurate positioning of holes, for example in a sequence or a square.
- Removable dust collection pod for easy emptying.
- Rechargeable lithium-ion powered battery with USB cable.
- **Model No. DDE01**
- List Price £33.95

£26.95 Exc. VAT
£32.34 Inc. VAT

Variable Speed Orbital Sanders 350W

350W **VARIABLE SPEED**



- Brushless motors adjust to the pressure applied maintaining a constant speed ensuring consistent sanding.
- Fitted with a dust extraction port.
- The well-balanced motors have very low vibration levels creating less user fatigue.
- Seven selectable speeds from 4,000-10,000rpm in 1,000rpm increments.
- LED digital display.
- Backing pad with 3mm orbit.
- Supplied with 1m dust extraction hose, hose adaptors (x2), 3mm hex key, sanding sheets (x6) (grits - P80, P100, P120, P150, P180, P240).
- For DAS152PS replacement sanding sheets, order Model No. SMTA10



Model No.	Backing Pad Size	List Price	Exc. VAT	Inc. VAT
DAS151PS	80 x 133mm	£199.95	£174.95	£209.94
DAS152PS	100 x 150mm Triangular	£199.95	£174.95	£209.94

Angle Grinders

Ø125mm 1100W

Model No. SAG125



Ø230mm 2000W

Model No. SAG230



- Suitable for a variety of trade applications.
- Both feature heavy-duty alloy bevel gear head with spindle lock for fast loading/unloading of discs.
- Vibration reducing double injection composite bodies with rubber coating for added comfort.
- Tool-less wheel guard adjustment.
- Built-in LED power indicator.
- Supplied with side handle and spanner.
- Fitted with over 2m of power cable and 3-pin plug.
- Model No. SAG230 features 2-stage trigger for added safety.
- Grinding discs not included, for SAG125 order Model No. PTC/125G and for SAG230 order Model No. PTC/230G

Model No.	Disc Size	Power	No-Load Speed	List Price	Exc. VAT	Inc. VAT
SAG125	Ø125mm	1100W	12000rpm	£64.95	£49.95	£59.94
SAG230	Ø230mm	2000W	6500rpm	£119.95	£84.95	£101.94

Ø115mm Angle Grinders 750W

Ø115mm 750W



- Both models Feature heavy-duty alloy bevel gear head with spindle lock for fast loading/unloading of discs.
- Vibration reducing double injection composite body with rubber coating for added comfort.
- Powerful 750W heavy-duty motor produces 11000rpm (no-load speed).
- Built-in LED power indicator.
- Supplied with side handle and spanner.
- Fitted with 1.8m of power cable and 3-pin plug.
- Grinding disc not included, order Model No. PTC/115G.

Model No.	Colour	List Price	Exc. VAT	Inc. VAT
SG115E	Red	£37.95	£29.95	£35.94
SG115EHV	Green	£37.95	£29.95	£35.94

Plastic Welding Kit including HS102 Hot Air Gun

Premier

3 YEAR GUARANTEE*



- Hot air gun Model No. HS102 with triple-range variable electronic temperature control.
- Suitable for plastic welding with nozzles provided and for paint stripping, soft soldering, removing sticky labels, defrosting frozen pipes etc.
- **Model No. HS102K**
- List Price £124.95

£99.95 Exc. VAT
£119.94 Inc. VAT

Variable Temperature

2000W Variable Temperature Hot Air Gun Kit

Variable Temperature



- 2-Step airflow control switch, with variable temperature range on both levels.
- Temperature Range: 50-450°C/90-600°C.
- Gun is designed to stand vertically, allowing use as a safe Bunsen burner alternative.
- Suitable for paint stripping, soft soldering, removing sticky labels and defrosting frozen pipes.
- Fitted 3-pin plug.
- Supplied with four nozzles and scraper all in a storage case.
- Airflow: 250, 500L/min.
- **Model No. HS107K**
- List Price £72.95

£53.95 Exc. VAT
£64.74 Inc. VAT

40W Electric Glue Gun

40W



- Composite housing with comfortable handle and trigger feed control.
- Fitted with 1.1m cable and 3-pin plug.
- Suitable for hardwoods, softwoods, plastics and other similar materials.
- Includes two glue sticks.
- **Model No. AK292**
- List Price £13.95

£9.95 Exc. VAT
£11.94 Inc. VAT

450W Glue Gun

450W



- Ready to use in less than 5mins.
- Unplug for cordless use once fully heated.
- On/off switch and trigger feed control.
- Composite housing with soft grip for added comfort.
- Suitable for Ø11 x 100mm glue sticks.
- Two glue sticks can be loaded at once.
- 25pc Glue stick packs available separately - Model No. AK292/2.
- Features magnets in handle base for adhering to metal stand when not in use.
- **Model No. AK2921**
- List Price £39.95

£31.95 Exc. VAT
£38.34 Inc. VAT

3.7V Cordless Glue Gun

3.7V



- Powered by a 3.7V 1.3Ah lithium-ion battery.
- Features LED light indicators to show when tool is ready to use.
- Ready to use in just 20 seconds.
- Operating time of 30mins on a full charge.
- Supplied with four glue sticks and USB charging cable.
- Suitable for Ø7.2mm glue sticks.
- **Model No. AK2923**
- List Price £29.95

£19.95 Exc. VAT
£23.94 Inc. VAT

All-Purpose Glue Stick - Pack of 25

- Hot melt glue sticks suitable for Sealey and other popular makes of glue guns.
- Overall Size: Ø11 x 100mm each.
- **Model No. AK292/2**
- List Price £5.95



£4.95 Exc. VAT
£5.94 Inc. VAT

Angle Driver

- Allows access with a power drill/driver to awkwardly positioned fixings.
- Suitable for 6mm hex bits and socket adaptors.
- Magnetic bit retention.
- **Model No. AK2104**
- List Price £9.95

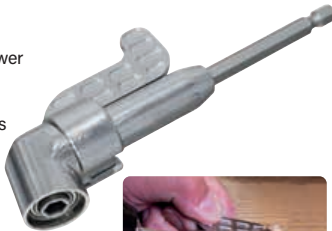

£7.95 Exc. VAT
£9.54 Inc. VAT

219pc Multipurpose Rotary Tool & Engraver Kit

VARIABLE SPEED

- Multipurpose high-speed power tool with on/off and electronic variable speed controls.
- Stepless control between 8,000 and 35,000rpm.
- Spindle lock for fast tool changes.
- Supplied with tips, wheels, sanding discs/bands, dressing stone and chuck spanner.
- Suitable for carving, shaping, deburring, drilling, engraving, cutting and tool sharpening.
- **Model No. E5188**
- List Price £74.95



£56.95 Exc. VAT
£68.34 Inc. VAT

18V 1/2" Sq Drive Cordless Impact Wrenches

18V **1/2" Sq Drive** **650Nm Torque**



Model No. CP650LI



Model No. CP650LIHV

- Variable speed trigger for greater control.
- Cast aluminium gearbox.
- Rubber gearhead cover.
- Thermal overload protection.
- Double injection body with rubber grips for added comfort.
- Brushless motor, which gives an improved performance and requires less maintenance than the brushed equivalent, giving you a more efficient, longer lasting tool.
- Produces torque of up to 650Nm(479lb.ft).
- Fitted with electronic brake.
- LED worklight illuminates work area when trigger is pressed.
- Supplied in storage case with 4Ah lithium-ion battery and fast charger.

Model No.	Colour	List Price	Exc. VAT	Inc. VAT
CP650LI	Red	£199.95	£139.95	£167.94
CP650LIHV	Green	£199.95	£139.95	£167.94

FAST CHARGE

VARIABLE SPEED

BRUSHLESS MOTOR

13W Tungsten Carbide Tipped Tool Engraver 230V



- Multipurpose high-speed engraver with on/off switch and variable stroke adjustment, which gives more control on workpiece.
- Suitable for engraving and etching on wood, metal, plastic and glass.
- Supplied with tip and two stencils.
- Fitted with 3-pin plug.
- **Model No. E541**
- List Price £32.95

£24.95 Exc. VAT
£29.94 Inc. VAT

90° Keyless Angle Driver

NEW Product



- 90° Angle allows access with a combi drill/driver to awkwardly positioned fixings.
- Ø9.5mm Drive shaft designed to fit any standard sized drill chuck.
- Adjustable handle can be mounted on both sides for fatigue-free working.
- Forward and reverse action keyless drill chuck for quick and efficient bit changes.
- Maximum speed of 500rpm.
- **Model No. AK2106**
- List Price £10.95

£8.95 Exc. VAT
£10.74 Inc. VAT

8pc Tile & Glass Drill Bit Set

NEW Product

- Able to drill into a range of materials including tiles, porcelain, ceramics and non-toughened glass.
- Blade tips manufactured from high quality YG6X tungsten carbide for a prolonged life.
- Carbon steel hex shank ensures anti-slip tight fit into electric, hand and bench drills.
- Spear tip shape for precise alignment.
- Designed to fit any standard sized drill chuck.
- Contents: Ø3-10mm in 1mm increments.
- **Model No. DBGC1**
- List Price £16.95

£11.95 Exc. VAT
£14.34 Inc. VAT



4pc Drill Brush Set

NEW Product



- Designed for scrubbing and cleaning a range of surfaces such as alloys, car seats, carpets, tiles and other surfaces.
- High quality PP bristles for tough scrubbing and cleaning.
- Drill brushes fixed to a 6.35mm (1/4") shank to fit any standard sized drill chuck.
- 150mm Quick chuck magnetic bit holder to allow for greater extension into hard-to-reach areas.
- **Model No. DBS4**
- List Price £8.95

£6.75 Exc. VAT
£8.10 Inc. VAT

Crimped Wire Wheels



Model No. BG150/WW1

- Brass coated steel wire wheels for 150 and 200mm bench grinders.
- Includes reduction bushes to fit 13, 16, 19, 22 and 25mm spindles (two of each size).
- Narrow wire wheel BG150/WW1 fits any 150mm Sealey brand grinder.
- Wide wire wheel BG150/WW2 will only fit BG150XW (Models prior to 1999).
- Narrow wire wheel BG200/WW1 fits any 200mm Sealey bench grinder and other popular brands.

Model No.	Size	List Price	Exc. VAT	Inc. VAT
BG150/WW1	Ø150 x 13mm	£21.95	£16.95	£20.34
BG150/WW2	Ø150 x 20mm	£25.95	£19.95	£23.94
BG200/WW1	Ø200 x 13mm	£25.95	£20.95	£25.14

Ø100mm Wire Wheels for SA695 Ø100mm

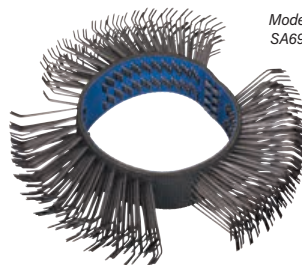

Model No. SA695WA

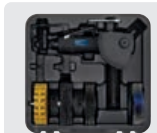

See page 76 for Smart Eraser Air Tool Kit. Model No. SA695



Model No. SA695WS

- Wire wheels for Model No. SA695 Smart Eraser Kit.
- Size: Ø100 x 25mm.

Model No.	Type	List Price	Exc. VAT	Inc. VAT
SA695WA	Angled	£34.95	£26.95	£32.34
SA695WS	Straight	£34.95	£26.95	£32.34

12pc 1/4" Shank Router Bit Set

NEW Product



Router not included.

- Assorted router bits with sturdy heads for long life.
- Sharp cutter heads made from YG8 alloy with a spray-painted surface to prevent accumulation of materials.
- Suitable for a wide variety of applications.
- Contents: Straight bits; 6, 12, 16mm, Bearing Flute Trim Bit; 12.7mm, 90° V Grooving Bit; 12.7mm, Dovetail Bit; 12.7mm, Roman Ogee Bit; R4mm, Cove Box Bit; R6.35mm, Bearing Cove Box Bit; R6.35mm, Round Over Bits; R6.35, R9.5mm, Bearing 45° Chamfer Bit; 32mm, Hexagon Key.
- **Model No. AK9912**
- List Price £29.95

£19.95 Exc. VAT
£23.94 Inc. VAT

SDS Plus Auger Wood Drill Bits

WORKSAFE by SEALEY

Model No. SA12X235



- SDS Plus auger wood drill bits are to the same specification as the auger drill bits but with the SDS Plus shank.
- Ideal for use with 2kg SDS Plus drills with hammer action switched off.
- Supplied in a plastic wallet.



Model No.	Size	Overall Length	List Price	Exc. VAT	Inc. VAT
SA8X200	Ø8mm	200mm	£3.00	£1.95	£2.34
SA10X235	Ø10mm	235mm	£3.55	£2.25	£2.70
SA12X235	Ø12mm	235mm	£3.75	£2.25	£2.70
SA13X235	Ø13mm	235mm	£3.95	£2.45	£2.94
SA14X235	Ø14mm	235mm	£4.55	£2.85	£3.42
SA16X235	Ø16mm	235mm	£5.55	£3.55	£4.26
SA19X235	Ø19mm	225mm	£6.25	£3.95	£4.74
SA20X235	Ø20mm	235mm	£6.75	£4.75	£5.70
SA22X235	Ø22mm	230mm	£7.75	£4.95	£5.94
SA25X235	Ø25mm	235mm	£9.25	£5.95	£7.14

Brassed Steel Crimped Wire Cup Brushes

Model No. CBC75



- Suitable for use with power tools.
- Crimped brass steel filaments add extra rigidity and cleaning power.

Model No.	Thread	Diameter	Max. Speed	List Price	Exc. VAT	Inc. VAT
CBC75	M10 x 1.5mm	Ø75mm	12500rpm	£7.95	£4.95	£5.94
CBC100	M14 x 2mm	Ø100mm	8500rpm	£13.95	£8.95	£10.74
CBC125	M14 x 2mm	Ø125mm	6500rpm	£15.95	£10.95	£13.14

Crimped Flat Wire Brushes Ø6mm Shaft



Model No. SFBS50

- Flat wire brushes with crimped stainless steel filaments with Ø6mm shaft.
- Maximum Speed: 4500rpm.

Model No.	Diameter	List Price	Exc. VAT	Inc. VAT
SFBS50	Ø50mm	£4.75	£2.95	£3.54
SFBS75	Ø75mm	£6.35	£3.95	£4.74
SFBS100	Ø100mm	£8.65	£5.95	£7.14

Ø75mm Twist Knot Flat Wire Wheel Ø6mm Shaft



- Twist knot flat wire wheel.
- Stainless Steel.
- Shaft: Ø6mm.
- Width: Ø75mm.
- Max. Speed: 12500rpm.
- **Model No. TKFBS75**
- List Price £8.95

£5.95 Exc. VAT
£7.14 Inc. VAT

Flap Wheels Ø6mm Shafts Packs of 5



Model No. FW4020405

- Aluminium oxide flap wheels on Ø6mm shaft, ideal for finishing curved and intricate metal surfaces.
- Suitable for use with power drills.
- Each model is supplied in a pack of five.

Model No.	Size	Grit	List Price	Exc. VAT	Inc. VAT
FW2510405	Ø25 x 10mm	40	£4.95	£3.65	£4.38
FW2510605	Ø25 x 10mm	60	£4.95	£3.65	£4.38
FW2510805	Ø25 x 10mm	80	£4.95	£3.65	£4.38
FW2510ASS	Ø25 x 10mm	40(x1), 60(x2), 80(x2)	£4.95	£3.65	£4.38
FW2520405	Ø25 x 20mm	40	£5.45	£3.95	£4.74
FW2520605	Ø25 x 20mm	60	£5.45	£3.95	£4.74
FW2520805	Ø25 x 20mm	80	£5.45	£3.95	£4.74
FW2520ASS	Ø25 x 20mm	40(x1), 60(x2), 80(x2)	£5.45	£3.95	£4.74
FW4020405	Ø40 x 20mm	40	£6.95	£4.95	£5.94
FW4020605	Ø40 x 20mm	60	£6.95	£4.95	£5.94
FW4020805	Ø40 x 20mm	80	£6.95	£4.95	£5.94
FW4020ASS	Ø40 x 20mm	40(x1), 60(x2), 80(x2)	£6.95	£4.95	£5.94
FW4030405	Ø40 x 30mm	40	£7.45	£5.45	£6.54
FW4030605	Ø40 x 30mm	60	£7.45	£5.45	£6.54
FW4030805	Ø40 x 30mm	80	£7.45	£5.45	£6.54
FW4030ASS	Ø40 x 30mm	40(x1), 60(x2), 80(x2)	£7.45	£5.45	£6.54
FW5025405	Ø50 x 25mm	40	£7.95	£5.95	£7.14
FW5025605	Ø50 x 25mm	60	£7.95	£5.95	£7.14
FW5025805	Ø50 x 25mm	80	£7.95	£5.95	£7.14
FW5025ASS	Ø50 x 25mm	40(x1), 60(x2), 80(x2)	£7.95	£5.95	£7.14
FW6030405	Ø60 x 30mm	40	£11.45	£8.45	£10.14
FW6030605	Ø60 x 30mm	60	£11.45	£8.45	£10.14
FW6030805	Ø60 x 30mm	80	£11.45	£8.45	£10.14
FW6030ASS	Ø60 x 30mm	40(x1), 60(x2), 80(x2)	£11.45	£8.45	£10.14
FW8040405	Ø80 x 40mm	40	£22.95	£15.95	£19.14
FW8040605	Ø80 x 40mm	60	£22.95	£15.95	£19.14
FW8040805	Ø80 x 40mm	80	£22.95	£15.95	£19.14
FW8040ASS	Ø80 x 40mm	40(x1), 60(x2), 80(x2)	£23.95	£16.95	£20.34

Decarbonising Crimped Wire Brushes

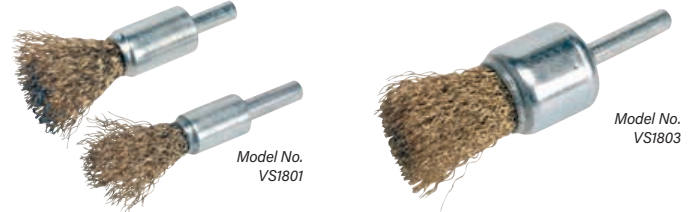

Model No. VS1801

Model No. VS1803

- Brassed and crimped steel brushes with flat and pointed fill.
- Suitable for decarbonising cylinder head ports and components.
- Shank Diameter: Ø6mm.

Model No.	Qty	Trim Diameter	Trim Length	List Price	Exc. VAT	Inc. VAT
VS1801	2pc	Ø15mm, Ø12mm	25mm	£6.95	£4.95	£5.94
VS1802	1pc	Ø13mm	20mm	£3.95	£2.75	£3.30
VS1803	1pc	Ø25mm	28mm	£4.35	£2.95	£3.54

100 x 600mm Hex Shank Mixer Paddle



- Designed to combine liquids so they're ready for use.
- Works great for paint, slurry, plaster, adhesives and textured coatings.
- Constructed using carbon steel with an electroplated finish.
- Fix the mixer into the chuck on your drill, then tighten.
- Use the rubber hanger supplied with the paddle mixer to store.
- **Model No. SR701**
- List Price £7.45

£4.95 Exc. VAT
£5.94 Inc. VAT

8pc Polishing Wheel Set



- Multipurpose accessory kit for buffing and polishing a variety of materials and objects.
- Able to be used on materials such as metal, aluminium, stainless steel, chrome, glass and more.
- Buffing and Polishing Wheel Set manufactured from soft grade cotton.
- Designed to fit any standard sized drill chuck.
- 6mm(1/4") Shank.
- Contents: Cloth Wheels; 50, 75, 100mm, 1/4" Shaft, 50mm Conical, 50mm Pattern, 38mm Cylindrical, 50mm Mushroom.
- **Model No. BGPW08**
- List Price £19.95

£13.95 Exc. VAT
£16.74 Inc. VAT

Deburring Tool with Blade



- Fast, effective and efficient way of deburring holes, slots and edges.
- Features aluminium body with pocket-clip and rotating replaceable cutting blade.
- For use on steel, copper, brass and plastic.
- Length: 147mm.
- **Model No. DB02**
- List Price £10.45

£6.95 Exc. VAT
£8.34 Inc. VAT

Deburring Tool with Spare Blade



- Composite handgrip with interchangeable swivel cutting bits.
- Spare cutter stored in handle.
- Suitable for deburring pipes and sheet materials.
- **Model No. DB01**
- List Price £14.95

£8.95 Exc. VAT
£10.74 Inc. VAT

7pc Multi-Tool Blade Set Metal & Wood



- 7pc Oscillating multifunction tool accessories set.
- Titanium coated.
- Contents: 69mm Bi-Metal blade WMT69 (x2), 34mm Bi-Metal Blade WMT34 (x2), 87mm Radial Bi-Metal Blade WMT87 (x1), 44mm Bi-Metal Blade WMT44 (x2).

- **Model No. WMTSET**
- List Price £29.95

£20.95 Exc. VAT
£25.14 Inc. VAT

3pc Quick Change Multi-Tool Cutting Blade Set



- Includes 10mm cutting blade, 32mm offset cutting blade and a 65mm offset cutting blade.
- Universal quick change fitting for use with Model No. SMT300Q and other leading brand multi-tools.
- Additional accessories available separately.
- **Model No. SMTC3**
- List Price £13.45

£8.95 Exc. VAT
£10.74 Inc. VAT

82pc Multi-Tool Sanding Set



- Contents: 80mm triangle sanding pad holder, 40 x 80mm triangle sanding pads - 80, 100, 120, 240Grit (10pc of each), finger sanding pad holder, 40 x finger sanding pads - 80, 100, 120, 240Grit (10pc of each).
- Suitable for use with CP20VMT and SMT300Q.
- **Model No. SMTA9**
- List Price £14.95

£11.95 Exc. VAT
£14.34 Inc. VAT

7pc All-Purpose Multi-Tool Blade Set



- Universal quick change fitting for use with Model No's SMT300Q, CP20VMT and other leading brand multi-tools.
- Includes: SMTA34FCW - 34mm HCS blade suitable for cutting wood, SMTA87W - 87mm HCS blade suitable for cutting wood, SMTA35TC - 35mm Carbide blade suitable for cutting ceramic, SMTA34W - 34mm HCS blade suitable for cutting wood, SMTA50TC - 50mm Stainless steel blade suitable for cutting ceramic, SMTA65TC - 65mm Carbide blade suitable for cutting ceramic, SMTA12 - 76mm Multi-Tool Triangle Backing Pad.
- Additional accessories available separately.
- **Model No. SMTS7**
- List Price £29.95

£19.95 Exc. VAT
£23.94 Inc. VAT

Ø115 x 1.2mm Cutting Disc Ø22mm Bore Pack of 10

Ø115mm



- General-purpose flat cutting disc recommended for use with Sealey and other manufacturers of grinding and cutting power tools.
- Suitable for cutting stainless steel.
- Supplied in metal tin.
- **Model No. PTC11510CET**
- List Price £12.95



£8.95 Exc. VAT
£10.74 Inc. VAT

115mm Production Sanding Rolls

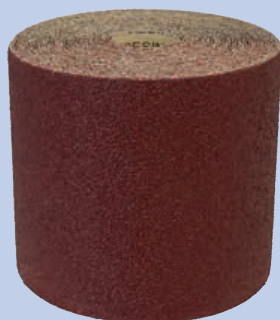

Model No. WSR1040



Model No. WSR1060

- Long lasting, heavy backing paper, suitable for orbital sanders.
- Industrial aluminium abrasive for use on wood, paint, plaster and fillers.

Model No.	Length	Type	Grit	List Price	Exc. VAT	Inc. VAT
WSR1040	10m	Extra Coarse	40	£9.95	£6.95	£8.34
WSR560	5m	Coarse	60	£5.75	£4.25	£5.10
WSR1060	10m	Coarse	60	£9.95	£6.95	£8.34
WSR10120	10m	Fine	120	£9.85	£6.95	£8.34
WSR5180	5m	Extra-Fine	180	£4.45	£3.35	£4.02
WSR10180	10m	Extra-Fine	180	£9.85	£6.95	£8.34
WSR5240	5m	Ultra-Fine	240	£5.25	£3.95	£4.74
WSR10240	10m	Ultra-Fine	240	£9.85	£6.95	£8.34

Sanding Belts - Packs of 5

- Aluminium oxide, super-flexible belts for Sealey and other belt sanders.

Model No.	Size	Grit	List Price	Exc. VAT	Inc. VAT
SA35/B40G	10 x 330mm	40	£9.45	£5.95	£7.14
SA35/B60G	10 x 330mm	60	£9.45	£5.95	£7.14
SA35/B80G	10 x 330mm	80	£9.45	£5.95	£7.14
SA35/B100G	10 x 330mm	100	£9.45	£5.95	£7.14
SA35/B120G	10 x 330mm	120	£9.45	£5.95	£7.14
SBS35/B40GW	12 x 456mm	40	£8.25	£6.45	£7.74
SBS35/B60GW	12 x 456mm	60	£8.25	£6.45	£7.74
SBS35/B80GW	12 x 456mm	80	£8.25	£6.45	£7.74
SBS35/B100GW	12 x 456mm	100	£8.25	£6.45	£7.74
SBS35/B120GW	12 x 456mm	120	£8.25	£6.45	£7.74
SA355/B60G	20 x 520mm	60	£12.45	£7.95	£9.54
SA355/B80G	20 x 520mm	80	£12.45	£7.95	£9.54
SA355/B100G	20 x 520mm	100	£12.45	£7.95	£9.54
SA355/B120G	20 x 520mm	120	£12.45	£7.95	£9.54

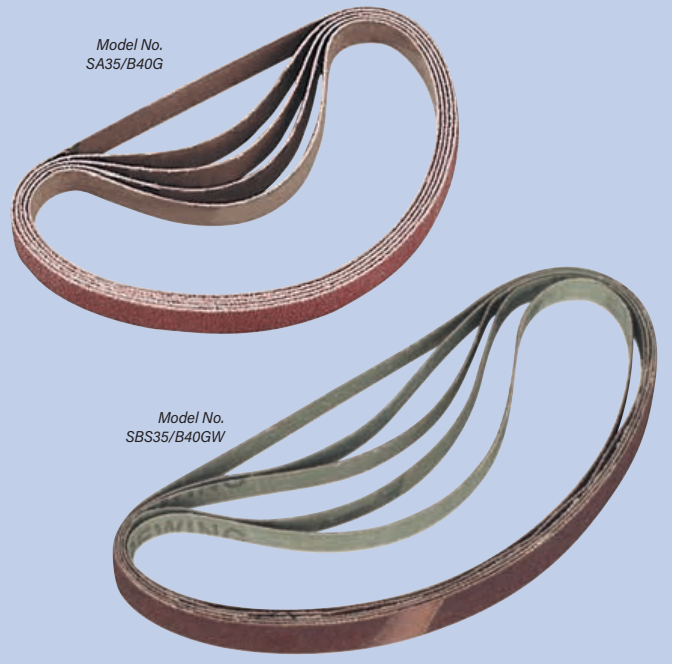

203 x 495mm Floor Sanding Sheets Packs of 5

NEW
Products

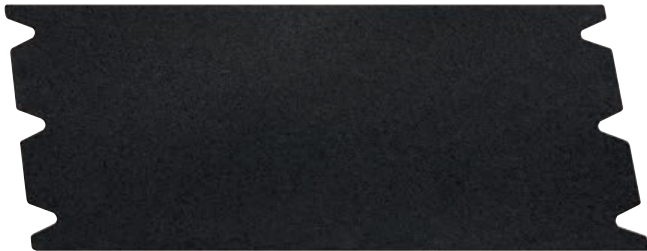

Model No. DU8405

- Heavy-duty silicone carbide paper.
- Suitable for renovating, sanding and fine finishing on wooden floors.
- For use with rotary drum sanders such as Clarke DU8, Clarke E2-8 and Hiretech HT-8.

Model No.	Grit	List Price	Exc. VAT	Inc. VAT
DU8405	40	£11.95	£4.25	£5.10
DU8605	60	£10.95	£3.95	£4.74
DU8805	80	£9.95	£3.75	£4.50

Multipurpose Wet & Dry Use Diamond Blades

- Suitable for cutting various building materials such as granite, masonry, concrete and hard bricks.
- Can be used for wet or dry cutting.
- 15mm Diamond segments allow for longer use per disc.



Ø115mm
Ø230mm
Ø300mm
OR
Ø350mm

Model No.	Diameter	Bore	List Price	Exc. VAT	Inc. VAT
WDMP115	Ø115mm	Ø22mm	£13.45	£6.95	£8.34
WDMP230	Ø230mm	Ø22mm	£38.95	£19.95	£23.94
WDMP300/20	Ø300mm	Ø20mm	£62.95	£32.95	£39.54
WDMP350/22	Ø350mm	Ø22mm	£76.95	£39.95	£47.94

Concrete Cutting Wet & Dry Use Diamond Blades

Ø115mm
Ø230mm
OR
Ø300mm



Model No. WDC230

- Ideal for cutting concrete.
- Cold pressed sintering allows the discs to be more durable.
- Can be used for wet or dry cutting.
- 15mm Diamond segments allow for longer use per disc.

Model No.	Diameter	Bore	List Price	Exc. VAT	Inc. VAT
WDC115	Ø115mm	Ø22mm	£12.45	£3.95	£4.74
WDC230	Ø230mm	Ø22mm	£23.95	£9.95	£11.94
WDC300/20	Ø300mm	Ø20mm	£57.95	£19.95	£23.94

Premium Blue WDA Diamond Blades

- Suitable for cutting abrasive materials including concrete blocks under 10Nm, concrete pavements, sandstone, arc block, limestone, green concrete, concrete roof tiles (under 10Nm) and breeze blocks.



Ø230mm
Ø300mm
Ø350mm
OR
Ø450mm

Model No.	Diameter	Bore	List Price	Exc. VAT	Inc. VAT
WDA230	Ø230mm	Ø22mm	£76.95	£31.95	£38.34
WDA300/20	Ø300mm	Ø20mm	£116.95	£64.95	£77.94
WDA300/22	Ø300mm	Ø22mm	£116.95	£64.95	£77.94
WDA350	Ø350mm	Ø25mm	£144.95	£79.95	£95.94
WDA450	Ø450mm	Ø25mm	£189.95	£104.95	£125.94

Our Rapid-Fit models are designed with a hinged system to fold-out from flat-pack to finish in minutes. They additionally feature:

- Stylish black MDF worktops and adjustable feet on base units.
- Magnetic door latches.
- Pegboard back panels for additional storage (except on stacking cabinet).
- Drawers feature ball-bearing drawer runners for smooth opening.
- Additional units are available to extend the storage system if required.

5 YEAR
GUARANTEE*

Superline
PRO



All of our modular units are heavy. Extra assistance must be provided at the delivery point to help safe delivery.

Some simple assembly required.



Rapid-Fit 2 Door Cabinet & Wall Cupboard



- Overall Size (W x D x H): 775 x 460 x 2080mm.
- **Model No. APMS2HFP**
- List Price £654.95

£499.95 Exc. VAT
£599.94 Inc. VAT

Rapid-Fit Dual Stacking Cabinets



- Comprised of two stackable units.
- Overall Size (W x D x H): 775 x 460 x 2080mm.
- **Model No. APMS2HFPS**
- List Price £599.95

£469.95 Exc. VAT
£563.94 Inc. VAT



Rapid-Fit 3.1m Modular Garage Storage System

5 YEAR
GUARANTEE*



- Can be freestanding or fixed to the wall.
- All 10 units supplied on a single pallet.
- Overall Size (W x D x H): 3100 x 460 x 2080mm.
- **Model No. APMS10HFP**
- List Price £2,479.95

£1,899.95 Exc. VAT
£2,279.94 Inc. VAT

Superline PRO® 3.24m Storage Systems



**5 YEAR
GUARANTEE***



Model No. APMSSTACK13W

Model No. APMSSTACK13SS



Superline PRO® Storage Systems

- ✓ Modular design to enable easy upgrading.
- ✓ Tough and durable construction with a hammered metal finish on the doors and drawers.
- ✓ Aluminium handles and drawer pulls.
- ✓ Ball-bearing slides throughout.
- ✓ Choice of worktop - pressed wood or stainless steel.
- ✓ Gas struts on wall cabinet doors or simple tambour front.
- ✓ Floor cabinets feature adjustable shelves.
- ✓ Each unit supplied with a lock and two keys (except wall cabinets).



Package includes:

- APMS55 - 600mm Full Height Modular Floor Cabinet (x2)
- APMS54 - 680mm Modular Wall Cabinet Tambour Front
- APMS53 - 680mm Modular Wall Cabinet (x2)
- APMS50BP - 615mm Modular Back Panel (x3)
- APMS50UCD - Modular System Upright Connector Double (x2)
- APMS50UCS - Modular System Upright Connector Single (x2)
- APMS64 - 1360mm 7 Drawer Modular Floor Cabinet
- APMS52 - 680mm 2 Door Modular Floor Cabinet

- APMS50WC - 2040mm Pressed Wood Worktop
- or
- APMS50SSC - 2040mm Stainless Steel Worktop

COMES WITH YOUR CHOICE OF WORKTOP, PRESSED WOOD OR STAINLESS STEEL.



Model No.	Worktop Material	List Price	Exc. VAT	Inc. VAT
APMSSTACK13W	Pressed Wood	£2,924.95	£1,949.95	£2,339.94
APMSSTACK13SS	Stainless Steel	£2,989.95	£2,049.95	£2,459.94

Superline PRO® 4.9m Storage Systems



**5 YEAR
GUARANTEE***



Model No. APMSSTACK16W

Model No. APMSSTACK16SS



Package includes:

- APMS64 - 1360mm 7 Drawer Modular Floor Cabinet
- APMS52 - 680mm 2 Door Modular Floor Cabinet
- APMS63 - 680mm Modular Reel Cabinet
- APMS66 - Modular Mobile Workshop Trolley
- APMS55 - 600mm Modular Full Height Floor Cabinet
- APMS56 - 915mm 2 Door Full Height Modular Floor Cabinet
- APMS54 - 680mm Modular Wall Cabinet Tambour Front (x2)
- APMS65 - 680mm 2 Door Modular Wall Cabinet
- APMS53 - 680mm Modular Wall Cabinet (x2)
- APMS50BP - 615mm Modular Back Panel (x5)
- APMS50UCD - Modular System Upright Connector Double (x4)
- APMS50UCS - Modular System Upright Connector Single (x2)

- APMS50WB - 1360mm Pressed Wood Worktop
- APMS50WC - 2040mm Pressed Wood Worktop
- or
- APMS50SSB - 1360mm Stainless Steel Worktop
- APMS50SSC - 2040mm Stainless Steel Worktop

COMES WITH YOUR CHOICE OF WORKTOP, PRESSED WOOD OR STAINLESS STEEL.

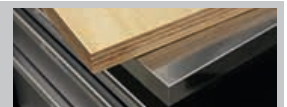

Model No.	Worktop Material	List Price	Exc. VAT	Inc. VAT
APMSSTACK16W	Pressed Wood	£4,249.95	£2,949.95	£3,539.94
APMSSTACK16SS	Stainless Steel	£4,379.95	£2,999.95	£3,599.94

Superline PRO® 2.04m Storage Systems

Superline PRO

5 YEAR GUARANTEE*

Ball Bearing Drawer Slides

Package includes:

- AMPS64 - 1360mm 7 Drawer Modular Floor Cabinet
- APMS65 - 680mm 2 Door Modular Wall Cabinet (x2)
- APMS54 - 680mm Modular Wall Cabinet Tambour Front
- APMS52 - 680mm 2 Door Modular Floor Cabinet
- APMS50BP - 615mm Modular Back Panel (x3)
- APMS50UCD - Modular System Upright Connector Double (x2)
- APMS50UCS - Modular System Upright Connector Single (x2)

Model No. APMSSTACK11W



Model No. APMSSTACK11SS

- APMS50WC - 2040mm Pressed Wood Worktop
- or
- APMS50SSC - 2040mm Stainless Steel Worktop



COMES WITH YOUR CHOICE OF WORKTOP, PRESSED WOOD OR STAINLESS STEEL.



Model No.	Worktop Material	List Price	Exc. VAT	Inc. VAT
APMSSTACK11W	Pressed Wood	£2,019.95	£1,449.95	£1,739.94
APMSSTACK11SS	Stainless Steel	£2,089.95	£1,499.95	£1,799.94

Superline PRO® 2.04m Storage Systems

Superline PRO

5 YEAR GUARANTEE*

Ball Bearing Drawer Slides

Package includes:

- APMS53 - 680mm Modular Wall Cabinet
- APMS54 - 680mm Modular Wall Cabinet Tambour Front
- APMS66 - Modular Mobile Workshop Trolley
- APMS50BP - 615mm Modular Back Panel (x3)
- APMS62 - 680mm 7 Drawer Modular Floor Cabinet
- APMS52 - 680mm 2 Door Modular Floor Cabinet
- APMS65 - 680mm 2 Door Modular Wall Cabinet
- APMS50UCD - Modular System Upright Connector Double (x2)
- APMS50UCS - Modular System Upright Connector Single (x2)

Model No. APMSSTACK12W



Model No. APMSSTACK12SS

- APMS50WC - 2040mm Pressed Wood Worktop
- or
- APMS50SSC - 2040mm Stainless Steel Worktop



COMES WITH YOUR CHOICE OF WORKTOP, PRESSED WOOD OR STAINLESS STEEL.



Model No.	Worktop Material	List Price	Exc. VAT	Inc. VAT
APMSSTACK12W	Pressed Wood	£1,779.95	£1,249.95	£1,499.94
APMSSTACK12SS	Stainless Steel	£1,849.95	£1,299.95	£1,559.94

Superline PRO® 1.96m Storage Systems



**5 YEAR
GUARANTEE***



Package includes:

- APMS64 - 1360mm 7 Drawer Modular Floor Cabinet
- APMS65 - 680mm Modular Wall Cabinet (x2)
- APMS55 - 600mm Full Height Modular Floor Cabinet
- APMS50BP - 615mm Modular Back Panel (x2)
- APMS50UCD - Double Modular System Upright Connector
- APMS50UCS - Single Modular System Upright Connector (x2)

Model No. APMSSTACK10W



Model No. APMSSTACK10SS

- APMS50WB - 1360mm Pressed Wood Worktop
or
- APMS50SSB - 1360mm Stainless Steel Worktop



COMES WITH YOUR CHOICE OF WORKTOP, PRESSED WOOD OR STAINLESS STEEL.



Model No.	Worktop Material	List Price	Exc. VAT	Inc. VAT
APMSSTACK10W	Pressed Wood	£1,889.95	£1,349.95	£1,619.94
APMSSTACK10SS	Stainless Steel	£1,939.95	£1,399.95	£1,679.94

Superline Pro® Topchest & Rollcab Combinations



**5 YEAR
GUARANTEE***



- Constructed from heavy gauged steel with steel inner walls for extra strength and durability.
- Heavy-duty 45mm ball-bearing drawer slides provide superior performance and carry heavier loads.
- Rust and solvent resistant powder coat paint finish.
- All drawers supplied with 2mm EVA drawer liner.
- One drawer safety system to prevent accidental tipping.
- Supplied with two keys.
- Rollcab design features perforated side panels for hanging tools and accessories (see B and C).
- Top and corners coated with plastic to avoid damage when moving around the workshop or garage.



Model No's AP3406 & AP3407 feature a plastic top tray with stainless steel insert.

Ref.	Model No.	Type	Drawers	Overall Size (W x D x H)	List Price	Exc. VAT	Inc. VAT	STACKS					
A	AP3401	Topchest	4	663 x 431 x 447mm	£384.95	£269.95	£323.94	Model No.	Package Includes	Overall Size (W x D x H)	List Price	Exc. VAT	Inc. VAT
B	AP3406	Rollcab	6	702 x 477 x 993mm	£664.95	£399.95	£479.94	AP3410STACK	AP3401, AP3406	702 x 477 x 1440mm	£979.95	£619.95	£743.94
C	AP3407	Rollcab	7	702 x 477 x 993mm	£664.95	£399.95	£479.94	AP3411STACK	AP3401, AP3407	702 x 477 x 1440mm	£999.95	£619.95	£743.94

SUPERLINE PRO® TOOL CHESTS



5 YEAR
GUARANTEE*

All heavy gauged steel construction and manufactured with steel inner walls for extra strength and durability. Heavy-duty 45mm ball-bearing drawer slides provide superior performance and carry heavier loads. Full height rear locking mechanism, locks full-length drawers in multiple locations. Added security provided by cylinder locks. Supplied with two keys. Rust and solvent resistant powder coat paint finish. Drawers ideally sized for fitting SEALY themed tool trays. Each drawer fitted with modern anodized black aluminium drawer pulls and supplied with non-slip liners.



5 Drawer Topchests



5 Drawer

- Overall Size (W x D x H): 660 x 435 x 490mm.
- Model No. AP26059TG - Grey
- Model No. AP26059THV - Green
- List Price £342.95

£259.95 Exc. VAT
£311.94 Inc. VAT

2 Drawer Mid-Boxes

- Overall Size (W x D x H): 670 x 440 x 210mm.
- Model No. AP26029TG - Grey
- Model No. AP26029THV - Green
- List Price £174.95



2 Drawer

£139.95 Exc. VAT
£167.94 Inc. VAT

7 Drawer Rollcabs



7 Drawer

- Includes four extra-heavy-duty Ø125mm PU/PP alloy wheels, two castors with large toe locks and two fixed wheels.
- Rollcabs feature a high polished chrome handle to enable smooth manoeuvrability.
- Also includes a 6mm thick top mat.
- Overall Size (W x D x H): 685 x 465 x 1005mm.
- Model No. AP26479TG - Grey
- Model No. AP26479THV - Green
- List Price £623.95

£479.95 Exc. VAT
£575.94 Inc. VAT

14 Drawer Topchest, Mid-Box & Rollcab Combinations



14 Drawer Combination

Packages include:

- 5 Drawer Topchest with Ball-Bearing Slides
- Overall Size (W x D x H): 660 x 435 x 490mm
- 2 Drawer Mid-Box with Ball-Bearing Slides
- Overall Size (W x D x H): 670 x 440 x 210mm
- 7 Drawer Rollcab with Ball-Bearing Slides
- Overall Size (W x D x H): 685 x 465 x 1005mm
- Model No. APSTACKTGR - Grey
- Model No. APSTACKTHV - Green
- List Price £1,089.95



These items are heavy. Extra assistance must be provided at the delivery point to help safe delivery.

£799.95 Exc. VAT
£959.94 Inc. VAT



Model No. APSTACKTGR

Push-to-Open Storage



4 Drawer Model No. APPD4G



4 Drawer Model No. APPD4O



7 Drawer Model No. APPD7G



11 Drawer Model No. APPDSTACKO

Topchests

- Rust and solvent resistant powder coat paint finish.
- Features a keyed lock with integrated side handles.
- Drawers include 45mm push-to-open ball bearing slides for hands-free operation.
- All drawers supplied with 2mm EVA drawer liner.
- Lid also features gas struts.

Rollcabs

- Constructed from heavy gauged steel with steel inner walls for extra strength and durability.
- Heavy-duty 45mm ball-bearing drawer slides provide superior performance and carry heavier loads.
- Fitted with Ø125mm castors with black chrome hubcaps, two swivel locking castors and two fixed.
- New and innovative 'Push-To-Open' drawer system for easy-opening, even when your hands are full.
- Rollcab design features perforated side panels for hanging tools and accessories.
- Rust and solvent resistant powder coat paint finish.
- All drawers supplied with 2mm EVA drawer liner.
- Top and corners coated with plastic to avoid damage when moving around the workshop or garage.
- Plastic top fitted with stainless steel insert.
- Fitted with cylinder locks and supplied with two keys.

Model No.	Type	Colour	Overall size (W x D x H)	List Price	Exc. VAT	Inc. VAT
APPD4G	Topchest	Green	662 x 431 x 477mm	£469.95	£369.95	£443.94
APPD4O	Topchest	Orange	662 x 431 x 477mm	£469.95	£369.95	£443.94
APPD7G	Rollcab	Green	702 x 477 x 993mm	£749.95	£529.95	£635.94
APPD7O	Rollcab	Orange	702 x 477 x 993mm	£749.95	£529.95	£635.94
APPDSTACKG	Combo	Green	APPD4G + APPD7G	£1,169.95	£849.95	£1,019.94
APPDSTACKO	Combo	Orange	APPD4O + APPD7O	£1,169.95	£849.95	£1,019.94

7 Drawer Rollcab with Graphics Pack Combos



Model No. AP26479TENG



Model No. AP26479TSCOT

Model No. AP26479TBWALES

Model No. AP26479TOIRE

Model No. AP26479TUJ

- Graphics are not pre-applied, but can be attached to the Rollcab easily using the two adhesive strips on the back of each piece.

Model No.	Rollcab Model No.	Graphics Pack Model No.	List Price	Exc. VAT	Inc. VAT
AP26479TENG	AP26479T	APTBG01 - Toolbox Graphics Pack - England	£659.95	£479.95	£575.94
AP26479TSCOT	AP26479TC	APTBG02 - Toolbox Graphics Pack - Scotland	£659.95	£479.95	£575.94
AP26479TBWALES	AP26479TB	APTBG03 - Toolbox Graphics Pack - Wales	£659.95	£479.95	£575.94
AP26479TOIRE	AP26479TO	APTBG04 - Toolbox Graphics Pack - Ireland	£659.95	£479.95	£575.94
AP26479TUJ	AP26479T	APTBG05 - Toolbox Graphics Pack - Union Jack	£659.95	£479.95	£575.94

Toolbox Graphics Packs

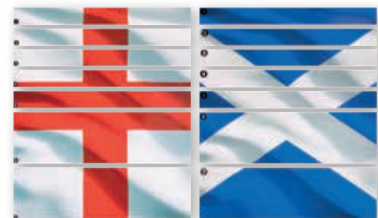

Model No. APTBG01

Model No. APTBG02



Model No. APTBG03

Model No. APTBG04

Model No. APTBG05

- Toolbox graphics packs compatible with Model No. AP26479T range of Rollcabs.
- Manufactured from 1.8mm reinforced, flexible and shatter resistant plastic.
- Fully resistant to water and oil.
- Two adhesive strips on the back of each piece make these easy to apply.

Model No.	Design	List Price	Exc. VAT	Inc. VAT
APTBG01	England	£87.95	£59.95	£71.94
APTBG02	Scotland	£87.95	£59.95	£71.94
APTBG03	Wales	£87.95	£59.95	£71.94
APTBG04	Ireland	£87.95	£59.95	£71.94
APTBG05	Union Jack	£87.95	£59.95	£71.94



15 Drawer Topchest & Rollcab Combinations with 148pc Tool Kit



Superline PRO
BLACK EDITION

15 Drawer Combination

Ball Bearing
Drawer Slides

5 YEAR GUARANTEE*

Toolchest comes with our 5 Year Guarantee*

LIFETIME GUARANTEE*

All Tool Tray contents come with our Lifetime Guarantee*



These items are heavy. Extra assistance must be provided at the delivery point to help safe delivery.

HEAVY DUTY

148pc TOOL KIT INCLUDED

- Heavy-duty 45mm ball-bearing drawer slides provide superior performance and carry heavier loads.
- Full height rear locking mechanism, locks full-length drawers in multiple locations.
- Overall Size (W x D x H): 685 x 465 x 1435mm.
- **Model No. APCOMBOBTK57 - Red**
- **Model No. APCOMBOBTK58 - Black**
- List Price £1,349.95

See www.sealey.co.uk for full contents.

£899.95 Exc. VAT
£1,079.94 Inc. VAT

9 Drawer 690mm Tower Cabinet with Soft Close Drawers & Power Strip

Superline PRO
BLACK EDITION

HEAVY DUTY

9 Drawer

5 YEAR GUARANTEE*

Ball Bearing
Drawer Slides



- All heavy-duty steel construction and manufactured with steel inner walls for extra strength and durability.
- Heavy-duty 45mm ball-bearing drawer slides provide superior performance, suitable for heavier loads.
- Full height rear locking mechanism, locks smooth running soft close drawers in place.
- Clamshell compartment has been specifically designed to be the perfect working height for diagnostic and data analysis screens.
- Rust and solvent resistant black crinkle effect finish.
- Supplied with a power strip (4 x 230V, 2 x 5V 2.4A USB sockets) which can be installed on either side.
- Fitted with four Ø125mm PP wheels with black chrome effect alloys, two castors with quick release anti-rotation toe locks and two fixed wheels.
- Side handle for added comfort when manoeuvring around the workplace.
- Each drawer features stylish black anodized heavy-duty drawer pulls and pre-cut non-slip liners.
- Supplied with two folding keys.
- This item is heavy. Extra assistance must be provided at the delivery point to help its safe delivery.
- **Model No. AP2709BE**
- List Price £1,139.95



£699.95 Exc. VAT
£839.94 Inc. VAT

Black Edition Tool Chest Combinations

Superline PRO
BLACK EDITION

5 YEAR GUARANTEE*

Ball Bearing
Drawer Slides

HEAVY DUTY



- All heavy gauged steel construction and manufactured with steel inner walls for extra strength and durability.
- Heavy-duty 45mm ball-bearing drawer slides provide superior performance.
- Full height rear locking mechanism, locks smooth running soft close drawers in place.

- Rollcabs are fitted with four Ø125mm PP wheels with black chrome effect alloys, two castors with quick release anti-rotation toe locks and two fixed wheels.
- Topchests feature robust side handles and are supplied with a power strip.

- Topchests also feature an independent drawer that can be locked separately.
- Drawers feature stylish black anodized heavy-duty drawer pulls and pre-cut non-slip liners.
- Supplied with two folding keys.



These items are heavy. Extra assistance must be provided at the delivery point to help safe delivery.

Model No.	Contents	Overall Size (W x D x H)	List Price	Exc. VAT	Inc. VAT
AP27BESTACK	AP2704BE - 4 Drawer 660mm Topchest with Soft Close Drawers & Power Bar, AP2705BE - 5 Drawer 680mm Rollcab with Soft Close Drawers	760 x 460 x 1620mm (inc. handle)	£1,179.95	£899.95	£1,079.94
AP36HBESTACK	AP36HBE - 910mm Toolbox Hutch with Power Strip, AP3606BE - 6 Drawer 915mm Rollcab with Soft Close Drawers	910 x 460 x 1615mm (inc. handle)	£1,349.95	£829.95	£995.94
AP36BESTACK	AP3607BE - 6 Drawer 910mm Topchest Soft Close Drawers & Power Strip, AP3606BE - 6 Drawer 915mm Rollcab with Soft Close Drawers	1001 x 458 x 1612mm (inc. handle)	£1,559.95	£1,099.95	£1,319.94
AP41HBESTACK	AP41HBE - 1030mm Toolbox Hutch with Power Strip, AP4111BE - 11 Drawer 1040mm Rollcab with Soft Close Drawers	1120 x 460 x 1695mm (inc. handle)	£1,599.95	£1,099.95	£1,319.94
AP41BESTACK	AP4106BE - 6 Drawer Topchest 1030mm with Soft Close Drawers & Power Bar, AP4111BE - 11 Drawer Rollcab 1040mm with Soft Close Drawers	1120 x 460 x 1650mm (inc. handle)	£1,799.95	£1,249.95	£1,499.94

14 Drawer Tool Chest Combinations with 446pc Tool Kit

**Superline
PRO**

**5 YEAR
GUARANTEE***

This modular 446pc tool kit offers a comprehensive range of Premier Platinum tools that are organised and easily accessible. There are seven spare drawers allowing storage of other tools not included in the trays.

- Premier Platinum Series tool trays are made from high quality EVA and provide superior protection and organisation for your tools.
- All heavy gauged steel construction and manufactured with steel inner walls.
- Heavy-duty 45mm ball-bearing drawer slides provide superior performance and carry heavier loads.
- Full height rear locking mechanism, locks full-length drawers in multiple locations.

Package includes:

- 5 Drawer Topchest with Ball-Bearing Slides
- Overall Size (W x D x H): 660 x 435 x 490mm
- 2 Drawer Mid-Box with Ball-Bearing Slides
- Overall Size (W x D x H): 670 x 440 x 210mm
- 7 Drawer Rollcab with Ball-Bearing Slides
- Overall Size (W x D x H): 685 x 465 x 1005mm
- 446pc Tool Kit
- TBTP02 - 91pc 1/4", 3/8" & 1/2" Sq Drive Socket Set with Tool Tray
- TBTP03 - 35pc Spanner Set with Tool Tray
- TBTP04 - 72pc Screwdriver Set with Tool Tray
- TBTP05 - 14pc Pliers Set with Tool Tray
- TBTP06UK - 13pc Hacksaw, Hammers & Punch Kit with Tool Tray
- TBTP07 - 177pc Specialised Bit & Socket Set with Tool Tray
- TBTP11 - 44pc Specialised Spanner Set with Tool Tray

• These items are heavy - extra assistance must be provided at the delivery point to help safe delivery.

- **Model No. TBTPCOMBO1 - Red**
- **Model No. TBTPCOMBO2 - Black**
- **Model No. TBTPCOMBO4 - Orange**
- **Model No. TBTPCOMBO5 - Blue**
- List Price £3,499.95

**446pc
TOOL KIT
INCLUDED**

£1,999.95 Excl. VAT
£2,399.94 Inc. VAT

**Premier
Platinum series**

**LIFETIME
GUARANTEE***

All Premier Tool Tray contents come with our Lifetime Guarantee*

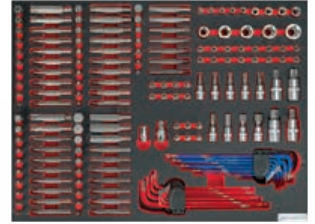

14 Drawer Extra-Wide Topchests



Model No. AP41149



Model No. AP41149B

14 Drawer
1025mm Extra-Wide



These items are heavy. Extra assistance must be provided at the delivery point to help safe delivery.

- All heavy gauged steel construction and manufactured with steel inner walls for extra strength and durability.
- Heavy-duty 45mm ball-bearing drawer slides provide superior performance and carry heavier loads.
- Full height rear locking mechanism, locks full-length drawers in multiple locations.
- Added security provided by tumbler lock, supplied with two folding keys.
- Rust and solvent resistant powder coat paint finish.
- Fitted with heavy-duty side handles.
- Each drawer features aluminium drawer pulls and non-slip liners.
- Overall Size (W x D x H): 1025 x 435 x 490mm.

Model No.	Colour	List Price	Exc. VAT	Inc. VAT
AP41149	Red	£749.95	£499.95	£599.94
AP41149B	Black	£749.95	£499.95	£599.94

16 Drawer Extra-Wide Rollcabs



16 Drawer

1050mm Extra-Wide



Model No. AP41169



Model No. AP41169B



These items are heavy. Extra assistance must be provided at the delivery point to help safe delivery.

- All heavy gauged steel construction and manufactured with steel inner walls for extra strength and durability.
- Heavy-duty 45mm ball-bearing drawer slides provide superior performance and carry heavier loads.
- Full height rear locking mechanism, locks full-length drawers in multiple locations.
- Added security provided by tumbler lock, supplied with two folding keys.
- Rust and solvent resistant powder coat paint finish.
- Includes four extra-heavy-duty Ø125mm PU/PP alloy wheels, two swivel castors with large toe locks and two fixed wheels.
- Features a high polished chrome handle to enable smooth manoeuvrability.
- Also includes a 10mm thick top mat.
- Each drawer features aluminium drawer pulls and non-slip liners.
- Overall Size (W x D x H): 1050 x 465 x 1005mm.

Model No.	Colour	List Price	Exc. VAT	Inc. VAT
AP41169	Red	£1,189.95	£849.95	£1,019.94
AP41169B	Black	£1,189.95	£849.95	£1,019.94

1 Drawer Extra-Wide Mid-Boxes

- All heavy gauged steel construction and manufactured with steel inner walls for extra strength and durability.
- Heavy-duty 45mm ball-bearing drawer slides provide superior performance and carry heavier loads.
- Full height rear locking mechanism, locks full-length drawers in multiple locations.
- Added security provided by tumbler lock, supplied with two folding keys.
- Rust and solvent resistant powder coat paint finish.
- Drawer features aluminium drawer pulls and non-slip liners.
- Overall Size (W x D x H): 1030 x 440 x 170mm.



Model No. AP41119



Model No. AP41119B

1 Drawer
1030mm Extra-Wide



Model No.	Colour	List Price	Exc. VAT	Inc. VAT
AP41119	Red	£197.95	£144.95	£173.94
AP41119B	Black	£197.95	£144.95	£173.94

10 Drawer Extra-Wide Topchests

- Extra-wide Topchests designed to take our modular tool trays.
- Overall Size (W x D x H): 1265 x 435 x 490mm.

Model No.	Colour	List Price	Exc. VAT	Inc. VAT
AP5210T	Red	£879.95	£624.95	£749.94
AP5210TB	Black	£879.95	£624.95	£749.94

13 Drawer Extra-Wide Rollcabs

- Extra-wide Rollcabs designed to take our modular tool trays.
- Overall Size (W x D x H): 1290 x 465 x 1005mm.

Model No.	Colour	List Price	Exc. VAT	Inc. VAT
AP5213T	Red	£1,389.95	£1,039.95	£1,247.94
AP5213TB	Black	£1,389.95	£1,039.95	£1,247.94

OR BUY AS A 23 DRAWER COMBINATION

Packages include:

- **AP52COMBO1** includes AP5210T and AP5213T - Red
- **AP52COMBO2** includes AP5210TB and AP5213TB - Black
- Overall Size (W x D x H): 1290 x 465 x 1495mm.

Model No.	Colour	List Price	Exc. VAT	Inc. VAT
AP52COMBO1	Red	£2,149.95	£1,399.95	£1,679.94
AP52COMBO2	Black	£2,149.95	£1,399.95	£1,679.94



Model No. AP52COMBO1



Model No. AP52COMBO2



These items are heavy. Extra assistance must be provided at the delivery point to help safe delivery.

Superline PRO® Black Edition Tool Storage

Superline
BLACK EDITION PRO

5 YEAR
GUARANTEE*

Model No.
AP6115BECOMBO2

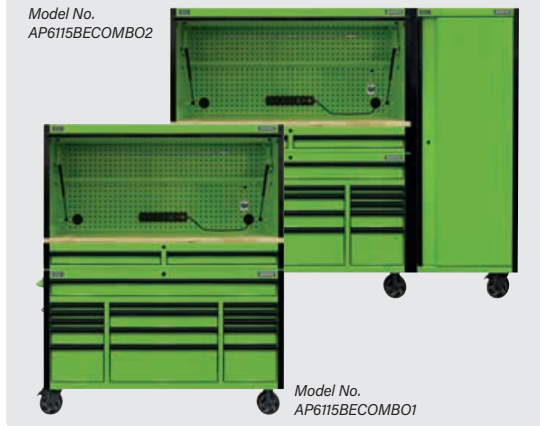

Model No.
AP6115BECOMBO1

- Modular storage system ideal for any garage/workshop.
- All heavy gauged steel construction and manufactured with steel inner walls for extra strength and durability.
- Heavy-duty 45mm ball-bearing drawer slides provide superior performance, suitable for heavier loads.
- Full height rear locking mechanism, locks smooth running, soft close drawers in place.
- Rust and solvent resistant gloss green finish.
- Rollcabs are fitted with four Ø152mm PP wheels with black chrome effect alloys, two castors with quick release anti-rotation toe locks and two fixed wheels.
- Hutch style topchests are supplied with a power strip (4 x 230V, 2 x 5V 2.4A USB sockets) which can be installed on either side.
- Topchests also fitted with gas struts for controlled opening/closing and are supplied with a two drawer mid-box with security lock.
- Throughout the Superline Pro® Black Edition range, each drawer features stylish black anodized heavy-duty drawer pulls and pre-cut non-slip liners. Supplied with two folding keys.

Model No. AP6103BE

2 Drawer

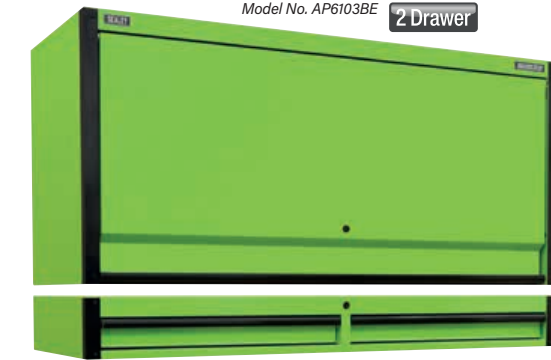

Model No. AP6115BE

15 Drawer



Model No.
AP6104BE

4 Shelves



These items are heavy. Extra assistance must be provided at the delivery point to help safe delivery.

Model No.	Type	External Dimensions (W x D x H)	List Price	Exc. VAT	Inc. VAT
AP6103BE	Top Hutch & 2 Drawer Riser	1549 x 584 x 716mm	£1,499.95	£1,349.95	£1,619.94
AP6104BE	Side Locker with Castors	698 x 584 x 1864mm	£1,199.95	£1,049.95	£1,259.94
AP6115BE	Mobile Trolley with Wooden Top	1549 x 584 x 979mm	£1,899.95	£1,749.95	£2,099.94
AP6115BECOMBO1	Combo	AP6103BE & AP6115BE	£3,199.95	£2,999.95	£3,599.94
AP6115BECOMBO2	Combo	AP6103BE, AP6104BE, AP6115BE	£4,299.95	£3,999.95	£4,799.94

10 Drawer Mobile Workstation

Superline
BLACK EDITION PRO

5 YEAR
GUARANTEE*

HEAVY
DUTY

Ball
Bearing
Drawer Slides

10 Drawer



- Heavy-duty steel construction and manufactured with steel inner walls for extra strength and durability.
- Fitted with four Ø125mm PP wheels with black chrome effect alloys, two fixed and two swivel with brakes.
- Rust and solvent resistant black crinkle effect finish with anodized black drawer and cupboard handles.
- Supplied with 25mm thick Rubberwood worktop.
- 10 Soft close drawers on 45mm ball bearing slides, two cupboards and pegboard back panel.
- Drawers and cupboard fitted with cylinder locks and each supplied with two keys.
- Some simple assembly required.
- Overall Size (W x D x H): 1421 x 650 x 1860mm.
- **Model No. AP5210BE**
- List Price £1,849.95

£1,379.95 Exc. VAT
£1,655.94 Inc. VAT



Self
Assemble



This item is heavy. Extra assistance must be provided at the delivery point to help safe delivery.

10 Drawer Topchests with 140pc Tool Kit



**140pc
TOOL KIT
INCLUDED**

- Topchests feature heavy gauged steel construction and steel inner walls.
- Heavy-duty ball-bearing drawer slides, aluminium drawer pulls and non-slip liners.
- Overall Size (W x D x H): 660 x 315 x 485mm.

See www.sealey.co.uk for full contents.

Model No.	Type	Colour	List Price	Exc. VAT	Inc. VAT
AP33109	Topchest Only	Red	£342.95	£299.95	£359.94
AP33109B	Topchest Only	Black	£342.95	£299.95	£359.94
AP33109COMBO	Combo	Red	£799.95	£479.95	£575.94
AP33109BCOMBO	Combo	Black	£799.95	£479.95	£575.94

Hang-On Lockers



- All heavy gauged steel construction and manufactured with steel inner walls for extra strength and durability.
- Full height rear locking mechanism, locks full-length drawers in multiple locations.
- Added security provided by tumbler locks, supplied with two folding keys.
- Rust and solvent resistant powder coat paint finish.
- Hang-on lockers suitable for Superline PRO® 12 and 16 drawer rollcabs.
- Features two adjustable shelves and a lockable drawer.
- Overall Size (W x D x H): 390 x 460 x 1325mm.
- **Model No. AP33519 - Red**
- **Model No. AP33519B - Black**
- List Price £464.95

£406.95 Exc. VAT
£488.34 Inc. VAT

7 Drawer Rollcabs with Ball-Bearing Slides



- Heavy-duty 45mm ball-bearing drawer slides provide superior performance and carry heavier loads.
- Full height rear locking mechanism, locks full-length drawers in multiple locations.
- Added security provided by tumbler locks, supplied with two folding keys.
- Includes four extra-heavy-duty Ø125mm PU/PP alloy wheels, two castors with large toe locks and two fixed wheels.
- Overall Size (W x D x H): 685 x 465 x 1005mm.
- **Model No. AP33479 - Red**
- **Model No. AP33479B - Black**
- List Price £623.95

£479.95 Exc. VAT
£575.94 Inc. VAT

3 Drawer Rollcab with 3 Drawer Utility Seat



- Constructed from heavy gauged steel with inner walls for extra strength and durability.
- Heavy-duty 45mm ball-bearing drawer slides.
- Fitted with Ø125mm castors with black chrome hubcaps, two swivel locking castors and two fixed.
- Rollcab design features two lockable side cabinets with pegboard and storage tray in each.
- Built-in storage for three drawer utility toolbox seat with 30mm cushion, two locking castors and two swivel.
- All drawers supplied with 2mm EVA drawer liner and 6mm EVA top mat.
- Supplied with two keys for main rollcab and two keys for utility seat.
- Overall Size (inc. castors): 679 x 461 x 986mm.
- **Model No. AP556CSHV**
- List Price £749.95

£499.95 Exc. VAT
£599.94 Inc. VAT

Super-Extra-Wide Toolchests with Ball-Bearing Slides



- Heavy-duty 45mm ball-bearing drawer slides provide superior performance and carry heavier loads.
- Non-slip liners for all drawers.
- Full height rear locking mechanism, locks drawers in multiple locations.
- Added security provided by cylinder locks, each supplied with two keys.
- Topchest features twin gas dampers keeps lid open for easy-access.
- Rollcab includes six extra-heavy-duty Ø125mm PU/PP alloy wheels, two fixed wheels and four swivel castors two of which are lockable.

75+ KG
HEAVY ITEM

Model No's AP6610 and AP6612 are heavy. Extra assistance must be provided at the delivery point to help safe delivery.

Model No.	Type	Overall Size (W x D x H)	List Price	Exc. VAT	Inc. VAT
AP6610	Topchest	1655 x 435 x 495mm	£1,039.95	£749.95	£899.94
AP6601	Mid-Box	1665 x 440 x 170mm	£327.95	£234.95	£281.94
AP6612	Rollcab	1680 x 465 x 1005mm	£1,679.95	£1,249.95	£1,499.94

4 Drawer Stainless Steel Mobile Tool Cabinet

Premier™ **STAINLESS STEEL** **HEAVY DUTY**
10 YEAR GUARANTEE* **4 Drawer** **Ball Bearing Drawer Slides**

- Anti-fingerprint stainless steel construction.
- Supplied with a 25mm thick wooden worktop.
- 45kg Drawer capacity.
- Two fixed and two locking swivel castors.
- Side handle for comfort and control when manoeuvring.
- Supplied with a lock and two keys.
- Overall Size (W x D x H): 1220 x 460 x 950mm.
- **Model No. AP4804SS**
- List Price £934.95

£699.95 Exc. VAT
£839.94 Inc. VAT

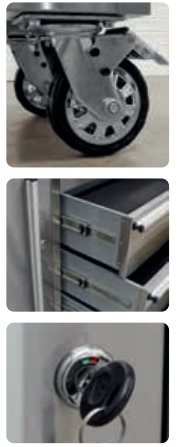

This item is heavy. Extra assistance must be provided at the delivery point to help safe delivery.

10 Drawer & 2 Wall Cupboard Stainless Steel Mobile Tool Cabinet with Backboard

Premier™ **STAINLESS STEEL** **HEAVY DUTY**
10 YEAR GUARANTEE* **Ball Bearing Drawer Slides**
10 Drawer

- Anti-fingerprint stainless steel construction.
- Supplied with a 38mm thick wooden worktop.
- 45kg Drawer capacity.
- Two fixed and two locking swivel castors.
- Pegboard back panel with gas strut wall cupboards.
- Side handle for comfort and control when manoeuvring.
- Supplied with locks and two keys each.
- Some simple assembly required.
- Overall Size (W x D x H): 1475 x 505 x 1860mm.
- **Model No. AP5520SS**
- List Price £1,669.95

£1,199.95 Exc. VAT
£1,439.94 Inc. VAT



This item is heavy. Extra assistance must be provided at the delivery point to help safe delivery.



Premier 3.55m Storage Systems

Premier™ **10 YEAR GUARANTEE*** **Ball Bearing Drawer Slides**
HEAVY DUTY

- APMS06 - 775mm Oak Worktop
- APMS07 - 1550mm Oak Worktop
- or
- APMS08 - 775mm Stainless Steel Worktop
- APMS09 - 1550mm Stainless Steel Worktop

Package includes:

- APMS13 - 775mm Heavy-Duty Modular Wall Cabinet
- APMS14 - 1550mm Heavy-Duty Modular Wall Cabinet
- APMS01 - 775mm Heavy-Duty Modular Floor Cabinet
- APMS04 - 1550mm Heavy-Duty 11 Drawer Modular Floor Cabinet
- APMS21 - 2108mm Heavy-Duty Modular Full Height Floor Cabinet (x2)
- APMS10 - 775mm Modular Back Panel
- APMS11 - 1550mm Modular Back Panel



These items are heavy. Extra assistance must be provided at the delivery point to help safe delivery.

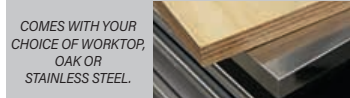

COMES WITH YOUR CHOICE OF WORKTOP, OAK OR STAINLESS STEEL.

Model No. APMSCOMBO7W

Model No. APMSCOMBO7SS



Model No.	Worktop Material	List Price	Exc. VAT	Inc. VAT
APMSCOMBO7W	Oak	£4,679.95	£3,399.95	£4,079.94
APMSCOMBO7SS	Stainless Steel	£4,899.95	£3,499.95	£4,199.94

PREMIER™ TOOL CHESTS

Premier™

10 YEAR
GUARANTEE

4 Drawer Heavy-Duty Topchests

Premier™

Heavy-duty welded steel construction for strength and durability, both solvent and rust resistant. Ball-bearing drawer slides provide superior performance and carry heavier loads, double sets on large drawers. All drawers have full width sand blasted aluminium 'Lift & Latch' drawer pulls. Supplied with non-slip drawer liners fitted to each drawer. Integral locking system locks all drawers with the turn of a key. Topchests feature heavy-duty exterior side handles. Gas struts fitted on lids for easy-opening. Rollcabs feature heavy-duty Ø125mm Mag style castors, two swivel with toe brakes and two fixed.



4 Drawer

Model No. PTB66004



4 Drawer

STAINLESS
STEEL



Model No. PTB66004SS

Ball
bearing
Drawer Slides

Lift
& Latch™
DRAWER PULLS

FULLY
EXTENDABLE
DRAWERS

HEAVY
DUTY

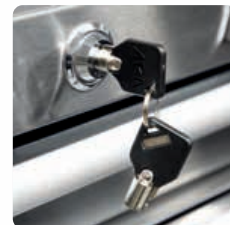

- Supplied with two keys.
- Model No. PTB66004 can be used with Model No. PTB67506 Rollcab or can be a standalone unit.
- Model No. PTB66004SS can be used with Model No. PTB67506SS Rollcab or can be a standalone unit.

Model No.	Finish	Drawers	Size (W x D x H)	List Price	Exc. VAT	Inc. VAT
PTB66004	Textured Powder Coat	4	660 x 450 x 565mm	£469.95	£329.95	£395.94
PTB66004SS	Stainless Steel	4	675 x 460 x 565mm	£624.95	£399.95	£479.94

6 Drawer Heavy-Duty Rollcabs

Premier™



6 Drawer

Model No. PTB67506



6 Drawer

Model No. PTB67506SS

STAINLESS
STEEL



- Supplied with two keys.
- Supplied with 12mm PVC coated MDF worktop for use as a workbench when not used with a topchest.
- Model No. PTB67506 can be used with Model No. PTB66004 Topchest or as a standalone unit.
- Model No. PTB67506SS can be used with Model No. PTB66004SS Topchest or as a standalone unit.

Model No.	Finish	Size (W x D x H)	List Price	Exc. VAT	Inc. VAT
PTB67506	Textured Powder Coat	675 x 460 x 1050mm	£759.95	£529.95	£635.94
PTB67506SS	Stainless Steel	675 x 460 x 1030mm	£914.95	£659.95	£791.94



Model No's PTB66004SS
and PTB67506SS

8 Drawer Extra-Wide Heavy-Duty Topchests

Premier™ 8 Drawer Extra-Wide



STAINLESS
STEEL



- Supplied with two keys.
- Model No. PTB104008 can be used with Model No. PTB105511 Rollcab or can be a standalone unit.
- Model No. PTB104008SS can be used with Model No. PTB105511SS Rollcab or can be a standalone unit.

Model No.	Finish	Size (W x D x H)	List Price	Exc. VAT	Inc. VAT
PTB104008	Textured Powder Coat	1040 x 450 x 570mm	£729.95	£549.95	£659.94
PTB104008SS	Stainless Steel	1055 x 450 x 565mm	£914.95	£679.95	£815.94

11 Drawer Extra-Wide Heavy-Duty Rollcabs

Premier™ 11 Drawer 1055mm Extra-Wide



STAINLESS
STEEL



These items are heavy. Extra assistance must be provided at the delivery point to help safe delivery.

- Supplied with two keys.
- Supplied with 12mm PVC coated MDF worktop for use as a workbench when not used with a topchest.
- Model No. PTB105511 can be used with Model No. PTB104008 Topchest or as a standalone unit.
- Model No. PTB105511SS can be used with Model No. PTB104008SS Topchest or as a standalone unit.



Model No.	Finish	Size (W x D x H)	List Price	Exc. VAT	Inc. VAT
PTB105511	Textured Powder Coat	1055 x 460 x 1050mm	£1,149.95	£899.95	£1,079.94
PTB105511SS	Stainless Steel	1055 x 460 x 1030mm	£1,349.95	£999.95	£1,199.94

**10 YEAR
GUARANTEE***

PREMIER™ TOOL CHESTS

Premier™

Retro Style Topchests, Mid-Boxes and Rollcabs with modern day functionality.

10 Drawer Retro Style Topchest, Mid-Box & Rollcab Combinations



Model No.
AP28COMBO2BWS

Model No.
AP28COMBO2BR

Model No.
AP28COMBO2



**HEAVY
DUTY**

**Ball
bearing
Drawer Slides**

**Lift
& Latch™
DRAWER PULLS**

4 DRAWER TOPCHEST

Overall Size (W x D x H):
700 x 450 x 495mm.

2 DRAWER MID-BOX

Overall Size (W x D x H):
710 x 460 x 270mm.

4 DRAWER ROLLCAB

Overall Size (W x D x H):
730 x 460 x 825mm.



These items are heavy.
Extra assistance must be
provided at the delivery point
to help safe delivery.

Package includes:

- AP28104BWS - 4 Drawer Retro Style Topchest
- AP28102BWS - 2 Drawer Retro Style Mid-Box
- AP28204BWS - 4 Drawer Retro Style Rollcab
- **Model No. AP28COMBO2BWS** - Blue with White Stripes
- List Price £1,299.95

or

- AP28104BR - 4 Drawer Retro Style Topchest
- AP28102BR - 2 Drawer Retro Style Mid-Box
- AP28204BR - 4 Drawer Retro Style Rollcab
- **Model No. AP28COMBO2BR** - Black with Red Anodised Drawer Pulls
- List Price £1,249.95

or

- AP28104 - 4 Drawer Retro Style Topchest
- AP28102 - 2 Drawer Retro Style Mid-Box
- AP28204 - 4 Drawer Retro Style Rollcab
- **Model No. AP28COMBO2** - Cream
- List Price £1,199.95

£899.95 Exc. VAT
£1,079.94 Inc. VAT

£849.95 Exc. VAT
£1,019.94 Inc. VAT

£849.95 Exc. VAT
£1,019.94 Inc. VAT

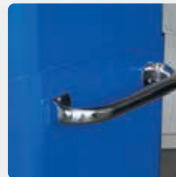

10 Drawer Retro Style Wide Topchest & Rollcab Combinations



4 DRAWER TOPCHEST

Overall Size (W x D x H):
1080 x 450 x 495mm.

6 DRAWER ROLLCAB

Overall Size (W x D x H):
1100 x 460 x 1040mm.



Package includes:

- AP41104BWS - 4 Drawer Wide Retro Style Topchest
- AP41206BWS - 6 Drawer Wide Retro Style Rollcab
- **Model No. AP41COMBOBWS** - Blue with White Stripes

or

- AP41104BR - 4 Drawer Wide Retro Style Topchest
- AP41206BR - 6 Drawer Wide Retro Style Rollcab
- **Model No. AP41COMBOBR** - Black with Red Anodised Drawer Pulls
- List Price £1,699.95

£1,349.95 Exc. VAT
£1,619.94 Inc. VAT



These items are heavy.
Extra assistance must be
provided at the delivery
point to help safe delivery.



Model No.
AP41COMBOBWS



Model No.
AP41COMBOBR

1830mm Heavy-Duty Steel Adjustable Workbenches

Premier™

10 YEAR GUARANTEE*

HEAVY DUTY

ADJUSTABLE HEIGHT

1.8m Table Width

1000kg



Model No. APMS22

- Manufactured from heavy gauge powder-coated steel, these adjustable workbenches are at the top end of our range, with a weight capacity of 1000kg (evenly distributed).
- Adjustable leg extensions allow worktop height to range from 680-1030mm.
- Base units can be placed underneath the worktop.
- Fitted with adjustable feet to ensure work surface is level, even if your floor is not.
- Order with your choice of worktop, Solid Wood or Stainless Steel.



Model No. APMS23

Model No.	Worktop Material	List Price	Exc. VAT	Inc. VAT
APMS22	32mm Thick Solid Wood	£644.95	£509.95	£611.94
APMS23	Stainless Steel	£729.95	£599.95	£719.94

8 Drawer Mobile Workstation with Ball-Bearing Slides

Premier™

Ball Bearing Drawer Slides

8 Drawer 2 Shelves

10 YEAR GUARANTEE*

Extra-Wide

- Heavy gauge steel with double wall construction for extra strength and durability.
- Fitted with oversized, heavy-duty Ø160mm wheels, two fixed and two locking castors.
- Ball-bearing drawer slides provide superior performance and carry heavier loads.
- Each drawer fitted with catch to prevent unexpected opening when being transported around the workshop.
- Added security provided by side mounted cylinder lock.
- Lockable cupboard with internal shelving for added storage.
- Supplied with four keys, two for drawers, two for cupboard.
- Heavy-duty stainless steel worktop makes these units very durable and a great workstation.
- Overall Size (W x D x H): 1130 x 565 x 1000mm.
- This item is heavy. Extra assistance must be provided at the delivery point to help its safe delivery.
- **Model No. AP2418**
- List Price £1,039.95



£799.95 Exc. VAT
£959.94 Inc. VAT

1600mm Mobile Tool Cabinet with Power Tool Charging Drawer

Superline BLACK EDITION PRO

HEAVY DUTY

5 YEAR GUARANTEE*

Ball Bearing Drawer Slides



- All heavy-duty steel construction and manufactured with steel inner walls for extra strength and durability.
- Heavy-duty 45mm ball-bearing drawer slides provide superior performance, suitable for heavier loads.
- Full height rear locking mechanism, locks smooth running soft close drawers in place.
- Rust and solvent resistant black crinkle effect finish.
- Fitted with six Ø125mm PP wheels with black chrome effect alloys, two fixed, two swivel and two swivel with brakes.
- Each drawer features stylish black anodized heavy-duty drawer pulls plus pre-cut non-slip liners.
- Power tool charging drawer fitted with 230V sockets (x4) and 5V 2.4A USB sockets (x2).
- Mounting points to fit additional four gang power strip - Model No. EL34USB (not included).
- Stainless steel 'flip-top' split equally into 2-sections providing a work surface and additional storage.
- Two cylinder locks allow drawers and power tool charging drawer to be locked separately.
- Overall Size (W x D x H): 1600 x 584 x 988mm.
- **Model No. AP6310BE**
- List Price £1,979.95



This item is heavy. Extra assistance must be provided at the delivery point to help safe delivery.



£1,499.95 Exc. VAT
£1,799.94 Inc. VAT

6 Drawer Mobile Tool Cabinets with Ball Bearing Slides

NEW Products

Available Mid April

Superline PRO

5 YEAR GUARANTEE*

Ball Bearing Drawer Slides

6 Drawer



Model No. AP366G



Model No. AP366HV

- Manufactured from double skin side walls.
- Full length locking bars secure all drawers when the lid is closed which can then be locked by the barrel lock supplied with two keys.
- Coated in high-gloss triple baked enamel for protection against oil, dirt and mild solvents.
- Full length TPR anti-shock protective bumpers on all corners prevent damage when moving around the workshop.
- Fitted with four stylish Ø5" x 2" castors, two fixed and two swivel with brakes and a durable shatterproof plastic side handle.
- Supplied with a can storage tray, waste bin and paper roll holder.
- Six soft close drawers each supplied with a cut-to-size non-slip liner.
- Deep storage compartment inside of the gas strut lid supplied with non-slip liner.
- Overall Size (W x D x H) - 973 x 482 x 1013mm.
- **Model No. AP366G - Grey**
- **Model No. AP366HV - Green**
- List Price £679.95

£579.95 Exc. VAT
£695.94 Inc. VAT



6 Drawer Rollcab with Ball-Bearing Slides & 298pc Tool Kit

Premier™ **Ball Bearing Drawer Slides** **HEAVY DUTY**

10 YEAR GUARANTEE*

LIFETIME GUARANTEE*

Rollcab comes with our 10 Year Guarantee*

All Tool Tray contents come with our Lifetime Guarantee*



298pc TOOL KIT INCLUDED **6 Drawer**

75+ KG HEAVY ITEM This item is heavy. Extra assistance must be provided at the delivery point to help safe delivery.

Package includes:

- Model No. AP2406
- 6 Drawer Rollcab with Ball-Bearing Slides
- Overall Size (W x D x H): 765 x 465 x 960mm

298pc Tool Kit includes:

- TBT01 - Tool Tray with 13pc Combination Spanner Set
- TBT02 - Tool Tray with 4pc Pliers Set
- TBT03 - Tool Tray with 4pc Circlip Pliers Set
- TBT07 - Tool Tray with 29pc Hex/Ball-End Hex Keys & Socket Bit Set
- TBT08 - Tool Tray with 35pc TRX-Star* Key, Socket Bit & Socket Set
- TBT09 - Tool Tray with 5pc Engineer's File Set
- TBT11 - Tool Tray with 60pc Security TRX-Star*/Hex/Ribe/Spline Bit Set
- TBT14 - Tool Tray with 6pc Screwdriver Set
- TBT17 - Tool Tray with 38pc Precision & Pick-Up Tool Set
- TBT19 - Tool Tray with 43pc 1/4"Sq Drive Socket Set
- TBT20 - Tool Tray with 35pc 3/8"Sq Drive Socket Set
- TBT21 - Tool Tray with 26pc 1/2"Sq Drive Socket Set
- **Model No. AP2406TBTC01**
- List Price £1,599.95

£949.95 Exc. VAT
£1,139.94 Inc. VAT

8 Drawer Rollcab with Ball-Bearing Slides & 707pc Tool Kit

Premier™ **Ball Bearing Drawer Slides** **HEAVY DUTY**

10 YEAR GUARANTEE*

LIFETIME GUARANTEE*

Rollcab comes with our 10 Year Guarantee*

All Tool Tray contents come with our Lifetime Guarantee*



707pc TOOL KIT INCLUDED **8 Drawer**



75+ KG HEAVY ITEM This item is heavy. Extra assistance must be provided at the delivery point to help safe delivery.

Package includes:

- Model No. AP2408
- 8 Drawer Rollcab with Ball-Bearing Slides
- Overall Size (W x D x H): 765 x 465 x 960mm

707pc Tool Kit arranged in 18 Modular Tool Trays, includes:

- Model No's: TBT01, TBT02, TBT03, TBT04, TBT07, TBT08, TBT09, TBT11, TBT13, TBT14, TBT16, TBT17, TBT18, TBT19, TBT20, TBT21, TBT23, TBT26
- **Model No. AP2408TTC08**
- List Price £2,299.95

£1,199.95 Exc. VAT
£1,439.94 Inc. VAT

14 Drawer Tool Chest Combination with 1233pc Tool Kit

Premier™

10 YEAR GUARANTEE*

Ball Bearing Drawer Slides **Extra Deep Topchest**

Rollcab comes with our 10 Year Guarantee*

HEAVY DUTY

LIFETIME GUARANTEE*

All Tool Tray contents come with our Lifetime Guarantee*

- Heavy gauge steel with double wall construction for extra strength and durability.
- Rust and solvent resistant powder coat paint finish.
- Ball-bearing drawer slides provide superior performance and carry heavier loads.
- Each drawer fitted with catch to prevent unexpected opening.
- Side mounted cylinder locks, supplied with two keys.
- Perforated side panels for hanging tools and accessories.

Package includes:

- Model No. AP2403
- 6 Drawer Topchest with Ball-Bearing Slides
- Overall Size (W x D x H): 690 x 465 x 535mm
- Model No. AP2408
- 8 Drawer Rollcab with Ball-Bearing Slides
- Overall Size (W x D x H): 766 x 465 x 960mm

1233pc Tool Kit arranged in 28 Modular Tool Trays includes:

- Model No's: TBT01, TBT02, TBT03, TBT04, TBT05, TBT06, TBT07, TBT08, TBT09, TBT11, TBT12, TBT13, TBT14, TBT15, TBT16, TBT17, TBT18, TBT19, TBT23, TBT24, TBT25, TBT26, TBT27, TBT28, TBT29, TBT30, TBT31, TBT32, TBTB.
- **Model No. APTTC02**
- List Price £3,999.95

75+ KG HEAVY ITEM This item is heavy. Extra assistance must be provided at the delivery point to help safe delivery.

1233pc TOOL KIT INCLUDED



6 Drawer

8 Drawer



£2,499.95 Exc. VAT
£2,999.94 Inc. VAT



5 Drawer Topchests with Ball-Bearing Slides



2 YEAR
GUARANTEE



5 Drawer



Model No. AP225B

Available
Mid April



Model No. AP225

- Features recessed carry handles, smooth 35mm ball-bearing slides and a cylinder lock with locking bar to secure the drawers in place for additional security.
- Supplied with two keys.
- Overall Size (W x D x H): 660 x 305 x 430mm.
- Small Drawer (x4): 565 x 270 x 45mm.
- Medium Drawer (x1): 565 x 270 x 70mm.
- **Model No. AP225 - Red**
- **Model No. AP225B - Black**
- List Price £233.95



£204.95 Exc. VAT
£245.94 Inc. VAT

6 Drawer Rollcabs with Ball-Bearing Slides



2 YEAR
GUARANTEE



6 Drawer



Model No. AP226



Model No. AP226B

- Features smooth 45mm ball-bearing drawer slides and a cylinder lock with locking bar to secure the drawers in place for additional security.
- Side handle and four castors (two fixed and two locking) to aid mobility around the workshop.
- Supplied with two keys.
- Overall Size (W x D x H): 680 x 460 x 950mm.
- **Model No. AP226 - Red**
- **Model No. AP226B - Black**
- List Price £467.95

£409.95 Exc. VAT
£491.94 Inc. VAT

3 Drawer Mid-Boxes with Ball-Bearing Slides



2 YEAR
GUARANTEE



3 Drawer



Model No. AP223B



Model No. AP223

- Additional storage to be used with Model No's AP225 Topchest and AP226 Rollcab.
- Features recessed carry handles, smooth 35mm ball-bearing slides and a cylinder lock with locking bar to secure the drawers in place for additional security.
- Supplied with two keys.
- Overall Size (W x D x H): 670 x 315 x 255mm.
- **Model No. AP223 - Red**
- **Model No. AP223B - Black**
- List Price £139.95

£122.95 Exc. VAT
£147.54 Inc. VAT

Complete Garage Storage System with 2 Mobile Trolleys



2 YEAR
GUARANTEE



- Complete garage and workshop storage solution.
- All units finished in tough and stylish black powder coating to protect against scratches, mild solvents and general day-to-day workshop use.
- Base units are fully mobile, fitted with 4" swivel castors to ensure your frequently used tools are always close by.
- All units are fully welded.
- Adjustable feet allow this storage unit to be levelled on uneven floors.
- Pegboard design wall panels offer extra storage.
- 1" Hardwood workbench.
- Some simple assembly required.
- **Model No. APMS120P**
- List Price £1,499.95

£1,179.95 Exc. VAT
£1,415.94 Inc. VAT



NEW
Product

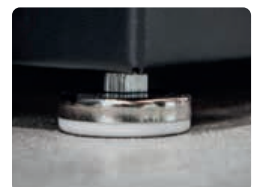

AMERICAN PRO® TOOL CHEST COMBOS



6 Drawer Topchest and Rollcab Combinations with 170pc Tool Kits. The economical way to buy American PRO® Ball-Bearing quality Tool Chests. Supplied packed one inside the other. These mid-size combos have smooth 25mm ball-bearing slides and all the features of the professional chests, except that the rollcab is not lockable and the castors are Ø75mm.



6 Drawer & Cupboard Combination

6 Drawer Topchest & Rollcab Combinations with 170pc Tool Kit



**170^{PC}
TOOL KIT
INCLUDED**

**2 YEAR
GUARANTEE***

Toolchests come with our 2 Year Guarantee*

**LIFETIME
GUARANTEE***

All Tool Tray contents come with our Lifetime Guarantee*



See www.sealey.co.uk for full contents.

- These boxes are not interchangeable with the rest of the American PRO® Ball-Bearing Range (except for the AP22309BB range of mid-boxes).
- 4 Drawer Topchest - Overall Size (W x D x H): 600 x 260 x 340mm.
- 2 Drawer Rollcab - Overall Size (W x D x H): 615 x 295 x 700mm.

Model No.	Colour	List Price	Exc. VAT	Inc. VAT
AP2200BBCOMBO	Red	£549.95	£329.95	£395.94
AP2200COMBOCP	Purple	£549.95	£329.95	£395.94
AP2200COMBOHV	Green	£549.95	£329.95	£395.94



6 Drawer Topchest & Rollcab Combinations with 170pc Tool Kit

**2 YEAR
GUARANTEE***

Toolchests come with our 2 Year Guarantee*

**LIFETIME
GUARANTEE***

All Tool Tray contents come with our Lifetime Guarantee*



**170^{PC}
TOOL KIT
INCLUDED**

- These mid-size combos have smooth 25mm ball-bearing slides and all the features of the professional chests except that the rollcab is not lockable and the castors are Ø75mm.
- These boxes are not interchangeable with the rest of the American PRO® Ball-Bearing Range.

Packages include:

- 4 Drawer Topchest
Overall Size (W x D x H): 600 x 260 x 340mm
- 2 Drawer Rollcab
Overall Size (W x D x H): 615 x 295 x 700mm
- LED091 - 1W SMD LED Penlight
- 9-in-1 Multi-Tool
- S0433 - 3pc 275mm Needle Nose Pliers Set
- S0437 - 275mm Offset Needle Nose Pliers
- S0447 - 3pc Plier Set
- S0448 - 3pc Adjustable Wrench Set
- S0465 - 25pc Hex Key Set
- S0865 - 2pc Engineer's Hacksaw Set
- AK2311 - Ø110mm Magnetic Collector
- S0529 - Retractable Utility Knife
- S0562 - 11pc Combination Spanner Set
- S0598 - 23pc Soft Grip Screwdriver & Bit Set
- S0610 - 2pc Pick-Up Tool Set
- S01210 - 94pc 1/4" & 1/2" Sq Drive Socket Set

Model No.	Colour	List Price	Exc. VAT	Inc. VAT
AP22HVGCOMBO	Green	£549.95	£369.95	£443.94
AP22RCOMBO	Red	£549.95	£369.95	£443.94
AP22BKCOMBO	Black	£549.95	£369.95	£443.94

3 Drawer Portable Tool Chests with Ball-Bearing Slides



2 YEAR
GUARANTEE



3 Drawer



Model No. AP9243BBHV



Model No. AP9243BB

- Storage capacity of a tool chest coupled with the versatility of a carry-type toolbox.
- Features tough composite top handle, smooth 25mm ball-bearing drawer slides and two strong locking hasps which can be locked using a padlock (not included).
- Overall Size (W x D x H): 510 x 225 x 300mm.
- Medium Drawer (x3): 455 x 190 x 45mm.
- **Model No. AP9243BB - Red**
- **Model No. AP9243BBHV - Green**
- List Price £114.95

£89.95 Exc. VAT
£107.94 Inc. VAT

6 Drawer Topchest & Rollcab Combinations with Ball-Bearing Slides



2 YEAR
GUARANTEE



- The economical way to buy American PRO® Ball-Bearing quality tool chests.
- Supplied packed one inside the other.
- These mid-size combos have smooth 25mm ball-bearing slides and all the features of the professional chests except that the rollcab is not lockable and the castors are Ø75mm.
- Overall Sizes (W x D x H): Topchest - 600 x 260 x 340mm, Rollcab - 615 x 295 x 700mm.
- Not interchangeable with the rest of the American PRO® Range (except for the AP22309BB range of mid-boxes).
- **Model No. AP2200BB - Red**
- **Model No. AP2200BBCP - Purple**
- **Model No. AP2200BBHV - Green**
- List Price £239.95

£194.95 Exc. VAT
£233.94 Inc. VAT

Magnetic Cable Tie Holders

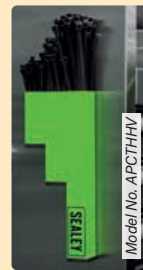

Model No. APCTHHV

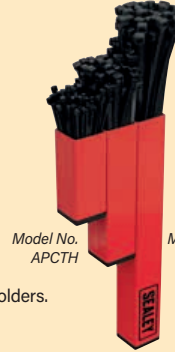

Model No. APCTH

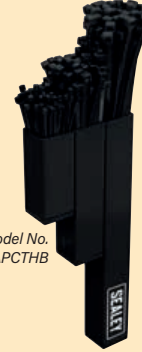

Model No. APCTHB



Model No. APCTHRLX

NEW Product

- Steel cable tie holders.
- Attaches to any ferrous surface.
- Magnetic fixings with rubber pads to prevent slipping.
- Industrial powder coated finish.
- Model No's APCTH, APCTHHV and APCTHB supplied with 200 cable ties in three sizes: 100, 160, 300mm.
- Model No APCTHRLX supplied with 500 cable ties in five sizes – 100 x 2.5mm, 160 x 4.5mm, 250 x 4.5mm, 300 x 4.5mm and 380 x 4.5mm.

Model No.	Colour	Capacity	List Price	Exc. VAT	Inc. VAT
APCTH	Red	200 Cable Ties	£27.95	£22.95	£27.54
APCTHHV	Green	200 Cable Ties	£27.95	£22.95	£27.54
APCTHB	Black	200 Cable Ties	£27.95	£22.95	£27.54
APCTHRLX	Red	500 Cable Ties	£49.95	£43.95	£52.74

6 Drawer Topchest & Rollcab Combinations with Ball-Bearing Slides



2 YEAR
GUARANTEE



- The economical way to buy American PRO® Ball-Bearing quality tool chests.
- Supplied packed one inside the other.
- These mid-size combos have smooth 25mm ball-bearing slides and all the features of the professional chests except that the rollcab is not lockable and the castors are Ø75mm.
- Overall Sizes (W x D x H): Topchest - 600 x 260 x 340mm, Rollcab - 615 x 295 x 700mm.
- Not interchangeable with the rest of the American PRO® Range.
- **Model No. AP22R - Red**
- **Model No. AP22HVG - Green**
- **Model No. AP22O - Orange**
- **Model No. AP22B - Blue**
- **Model No. AP22BK - Black**
- List Price £239.95

£189.95 Exc. VAT
£227.94 Inc. VAT

Adjustable Height Mobile Workstation



- Features four compartments, one large for main workpiece and three equal sized smaller sections for accessories.
- Rubber lining on the table helps prevent damage to the unit and workpiece.
- Supplied with four castor wheels.
- Table Size (W x D): 730 x 505mm.
- Min./Max. Height: 890/1190mm.
- **Model No. AP200**
- List Price £144.95

25kg Capacity

ADJUSTABLE HEIGHT

£114.95 Exc. VAT
£137.94 Inc. VAT

Portable Folding Workbench



- Powder coated steel foldable workbench with wooden work surface.
- Built-in storage bar for easy storage and access to tools.
- Folds and unfolds in seconds for quick set-up wherever required.
- Ergonomic composite handle and lightweight at only 14kg for ease of carrying.
- Worktop marked with 960mm measuring scale and 180° protractor.
- Supplied with slot in cross bar for added stability.
- Worktop area (W x L): 1000 x 600mm.
- Maximum weight capacity: 100kg.
- **Model No. FWB1000**
- List Price £109.95

1m Table Width

Folding

£84.95 Exc. VAT
£101.94 Inc. VAT

Wall Mounted Foldable Workbenches



Model No. APWMW01



Model No. APWMW02

- Heavy-duty hammered metal workbenches with 100kg capacity.
- Supplied with 600mm wall mount bracket and hardware pack.
- Back panel pegboard design compatible with Sealey TTS Hooks with a 10cm deep gap for tool storage.
- Lockable design for added security of contents within.
- Features two cable and plug grommet holes either side for corded tools or power strip.

Model No.	Overall Size (W x D x H)	List Price	Exc. VAT	Inc. VAT
APWMW01	914 x 620 x 560mm	£199.95	£149.95	£179.94
APWMW02	1100 x 670 x 610mm	£249.95	£189.95	£227.94



5 YEAR GUARANTEE*



Heavy-Duty Steel Workbench with 25mm MDF Top



- Thick 25mm MDF top and powder coated steel frame.
- Four adjustable feet for levelling on uneven ground.
- Maximum Load 500kg distributed evenly.
- Size (W x D x H): 1800 x 600 x 910mm.
- Some simple assembly required.
- **Model No. AP0618**
- List Price £489.95

1.8m Table Width

HEAVY DUTY

£399.95 Exc. VAT
£479.94 Inc. VAT

Woodworking Bench



- Made from oak with a varnished finish.
- Features tool well, shelf, tool drawer, front and end vices, four metal bench stops and four wooden board jacks.
- Vice Dimensions (x2): 280mm Wide x 190mm Opening.
- Bench Dimensions (W x D x H): 1520 x 620 x 850mm.
- Worktop Dimensions (W x D): 1390 x 355mm.
- **Model No. AP1520**
- List Price £209.95

£179.95 Exc. VAT
£215.94 Inc. VAT

1.2m Workstation with Drawers

1.2m Table Width

Ball Bearing Drawer Slides

100kg Capacity

- Boltless designed frame makes the unit easy to assemble, with minimal tools being required.
- Pegboard rear panel, plus hooks for convenient tool storage.
- Two half drawers, with ball-bearing slides, and shelf below worktop.
- Worktop: 1205 x 600mm.
- Capacity of Worktop and Bottom Shelf: 100kg.
- 230mm Shelf above pegboard.
- Size (W x D x H [Overall/Worktop]): 1215 x 610 x 1500/900mm.
- **Model No. AP12600**
- List Price £209.95

£139.95 Exc. VAT
£167.94 Inc. VAT



3-Level Composite Workshop Trolley with Parts Storage



- Composite garage workshop trolley featuring aluminium corner posts.
- Each shelf features three compartments with removable dividers, seven tool holder slots, four additional compartments for small fixings and two cup/can holders.
- These features allow for all of your tools and equipment to be on-hand and easily accessed.
- Quick and easy to assemble, with four swivel castors, two featuring brakes.
- Overall Size (W x D x H): 570 x 455 x 895mm.
- **Model No. CX313**
- List Price £124.95



30kg
PER LEVEL

£89.95 Exc. VAT
£107.94 Inc. VAT

3-Level Folding Workshop Trolley

Folding

- Folding composite garage workshop trolley with a 25kg capacity per shelf.
- Walls on all four sides to stop items from sliding off the trolley.
- Four large castors, two locking.
- Can also be used as a janitorial trolley.
- Folds up in seconds for easy storage when not in use.
- Overall Size (W x D x H): 670 x 430 x 855mm.
- **Model No. CX314**
- List Price £134.95



25kg
PER LEVEL

£99.95 Exc. VAT
£119.94 Inc. VAT

2 Drawer Heavy-Duty Mobile Tool & Parts Trolleys with Lockable Top

Superline PRO

HEAVY DUTY

Ball Bearing Drawer Slides

5 YEAR GUARANTEE*

- Garage or workshop trolleys with two shelves and a lockable gas sprung supported lid, which allows for items to be kept safe when not in use.
- Two 40kg capacity drawers with ball-bearing slides.
- Additional screwdriver holder.
- Lower storage shelves can be installed base down or base up.
- Four heavy-duty 4" PU castors, two of which are locking.
- Overall Size inc. Handle (W x D x H): 925 x 440 x 900mm.
- **Model No. AP760MHV - Green**
- **Model No. AP760M - Red**
- **Model No. AP760MO - Orange**
- List Price £354.95



£259.95 Exc. VAT
£311.94 Inc. VAT

4-Level Multipurpose Trolley for Diagnostics

Superline PRO

5 YEAR GUARANTEE*

- Ideal for diagnostics and general use around the workshop.
- Tough industrial powder coated finish.
- Four open shelves with 10mm EVA liner on top shelf.
- Lockable compartment supplied with two keys.
- Two front steering swivel castors and two rear fixed wheels.
- Supplied with side tray and paper towel holder.
- Side pegboard panel which will work with the Sealey TTS range of hooks.
- Compact design.
- Size (W x D x H): 435 x 522 x 1178mm.
- **Model No. APDT435**
- List Price £459.95



£349.95 Exc. VAT
£419.94 Inc. VAT

Heavy-Duty Mobile Tool & Parts Trolleys with 5 Drawers & Lockable Top

Superline PRO

HEAVY DUTY

Ball Bearing Drawer Slides

5 YEAR GUARANTEE*



- Overall capacity of 320kg evenly distributed.
- Five drawers are lined with non-slip liners and come with ball-bearing slides.
- Features rear locking mechanism adding extra security.
- Extra hand tool storage slots are situated on either side within the top compartment.
- Lined lower shelf is ideal for larger parts or tool storage.
- Fitted with a side handle, two fixed castors and two swivel castors with toe brakes to aid manoeuvrability around the workshop or garage.
- Overall Size (W x D x H): 940 x 515 x 1050mm.
- **Model No. AP890M - Red**
- **Model No. AP890MHV - Green**
- List Price £479.95

£399.95 Exc. VAT
£479.94 Inc. VAT



Composite Heavy-Duty Trolleys



113kg
PER LEVEL

Model No. CX202

- Manufactured from extra-strong impact resistant plastic.
- Features deep wall shelves and tool storage compartments built into the contoured handle.
- Fitted with four large rubber wheels, two fixed and two swivel castors.



83kg
PER LEVEL

Model No. CX203

HEAVY DUTY

3pc Heavy-Duty Mobile Storage System Set

HEAVY DUTY

NEW Product

- Heavy-duty toolbox stack manufactured from shockproof plastic.
- Bottom box fitted with two 7" rubber coated castors and a 3-stage aluminium handle.
- Each of the three toolboxes have internal rubber seals and metal locking clasps to keep tools inside protected against light showers.
- Top two boxes can be stacked in an order to suit your preference and each has its own carry handle.
- **Model No. AP890**
- List Price £179.95



Model No.	No. of Levels	Capacity	Overall Size (W x D x H)	List Price	Exc. VAT	Inc. VAT
CX202	2	113kg/level	1000 x 440 x 850mm	£229.95	£179.95	£215.94
CX203	3	83kg/level	1000 x 440 x 850mm	£289.95	£199.95	£239.94

£139.95 Exc. VAT
£167.94 Inc. VAT

2-Level Heavy-Duty Trolley with Lockable Drawer

Superline PRO

5 YEAR GUARANTEE*

HEAVY DUTY

Ball Bearing Drawer Slides



80kg
PER LEVEL

- Garage or workshop trolley with an 80kg capacity per shelf.
- Deep-walled shelves, which may be installed base down or base up to give either tool and component security or unobstructed access.
- Full-width, lockable drawer with ball-bearing slides.
- Four large castors, two fitted with a brake.
- Size (W x D x H): 760 x 410 x 900mm.
- **Model No. CX101D**
- List Price £219.95

£174.95 Exc. VAT
£209.94 Inc. VAT

2-Level Heavy-Duty Trolley with Lockable Top & 2 Drawers

Superline PRO

5 YEAR GUARANTEE*

HEAVY DUTY

Ball Bearing Drawer Slides



80kg
PER LEVEL

TOOLS NOT INCLUDED

- Workshop trolley with an 80kg capacity per shelf.
- Upper shelf has liner and lockable top.
- Lower shelf may be installed base down or base up to give either tool and component security or unobstructed access.
- Two lockable drawers with ball-bearing slides and liners, give additional tool security.
- Four large castors, two fitted with a brake.
- Size (W x D x H): 815 x 410 x 985mm.
- **Model No. CX1042D**
- List Price £314.95

£259.95 Exc. VAT
£311.94 Inc. VAT

45L Weatherproof Trailer Storage Box with Lock

NEW Product

45L



- Easy to use combination lock ensures contents are secure from theft or damage.
- Weatherproof compression locking seal makes sure contents are fully protected.
- Supplied with brackets and hardware to mount to a trailer.
- Features a water and dust-tight foam gasket.
- Designed to utilise the space on a trailers A-frame, for securely storing tools and equipment.
- Manufactured from high quality polypropylene which is highly resistant to UV rays and well suited to a wide range of temperatures.
- **Model No. STB690**
- List Price £84.95

£74.95 Exc. VAT
£89.94 Inc. VAT

Cargo Storage Cases



Model No. RMC710



Model No. RMC870

- Rotationally moulded from heavy-duty polypropylene material, which is also UV stabilized and impact resistant.
- Features a water and dust-tight rubber seal.
- Recessed latches for added security to help prevent the use of bolt croppers.
- Ideal for the safe storage of tools, electronics and photographic equipment.
- Cases will not rust or dent and are resistant to water, dust, chemicals and oil.
- Suitable for a variety of applications including pickup trucks, shipping, storage and use with roof racks.
- Specially designed base and lid enables cases to be stacked efficiently and reduces movement when in transit.

Model No.	Capacity	External Size (W x D x H)	List Price	Exc. VAT	Inc. VAT
RMC710	62L	710 x 425 x 330mm	£229.95	£189.95	£227.94
RMC870	131L	870 x 530 x 425mm	£364.95	£299.95	£359.94
RMC1020	237L	1020 x 620 x 510mm	£519.95	£439.95	£527.94

Multipurpose Storage Hook Kits



Model No.
APHKIT2

- Contain wall mountable hook rails with predrilled mounting holes.
- Ideal for use in a garage, shed or around the home to save space.
- Powder coated to prevent oxidation.
- PVC Wrapped to avoid damage to tools and equipment.
- Easy to install and easy to relocate.
- Each hook holds up to 20kg. Overall maximum load on single hook rail 110kg.



Model No.
APHKIT2



Model No.
APHKIT3

Model No.	Qty	Kit Contents	List Price	Exc. VAT	Inc. VAT
APHKIT2	10pc	APH01 - Wall Mountable Storage Rail (x3), APH03 - Large J Storage Hook (x2), APH04 - Double Prong Storage Hook (x2), APH08 - Double S Storage Hook (x1), APH09 - Single Prong Storage Hook (x2)	£54.95	£24.95	£29.94
APHKIT3	9pc	APH01 - Wall Mountable Storage Rail (x2), APH02 - Storage Hook for Power Tool, APH03 - Large J Storage Hook, APH11 - Single S-Prong Storage Hook (x2), APH14 - Storage Basket, APH13 - 4-Way Storage Hook, APH12 - Dual Utility Storage Hook	£66.95	£29.95	£35.94

Modular Van Storage Systems



**5 YEAR
GUARANTEE**



Model No.
APMSVCOMBO1



Model No.
APMSVCOMBO2



Model No.
APMSVCOMBO3



- Universally designed to fit medium and large vans.
- Versatile shelves and dividing system allows you to maximize your storage space with minimal effort with lockable door (APMSV03) included.
- Designed to fit close to the interior walls of the van freeing up precious floor space.
- Robust steel construction.
- Perforated tool side panels to maximize space.
- Four shelves that can be height adjusted in 25mm increments.
- Supplied flat-packed with six brackets to ensure security and rigidity.
- Overall Size (W x D x H): 926 x 380 x 1300mm.

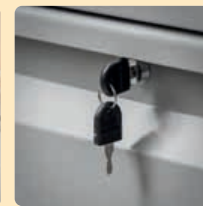

Model No.	Kit Contents	List Price	Exc. VAT	Inc. VAT
APMSVCOMBO1	APMSV01 - 925mm Modular Flat Shelf Van Storage Unit (x1), APMSV03 - 845mm Modular Lockable Storage Door (x1)	£329.95	£229.95	£275.94
APMSVCOMBO2	APMSV02 - 925mm Modular Slanted Shelf Van Storage Unit (x1), APMSV03 - 845mm Modular Lockable Storage Door (x1)	£299.95	£219.95	£263.94
APMSVCOMBO3	APMSV01 - 925mm Modular Flat Shelf Van Storage Unit (x1), APMSV02 - 925mm Modular Slanted Shelf Van Storage Unit (x1), APMSV03 - 845mm Modular Lockable Storage Door (x1)	£589.95	£419.95	£503.94

15A Accessory Circuit Fuse Holder Links Packs of 2

15A

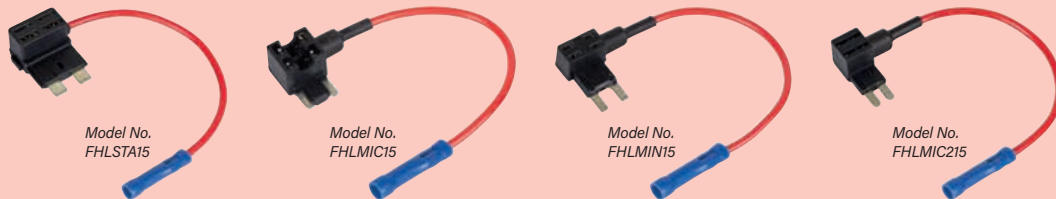

- Range of fuse holders for quick and easy installation of an accessory circuit.
- Simply remove an existing fuse and insert the fuse holder.
- Contains two fuse slots, one for the vehicles existing fuse and a second fuse slot for the accessory.
- Made from nylon and supplied with 150mm of 16 gauge wire.
- Maximum rated current 15A.

Model No.	Type	List Price	Exc. VAT	Inc. VAT
FHLSTA15	Standard	£6.45	£4.95	£5.94
FHLMIC15	Micro	£7.65	£5.95	£7.14
FHLMIN15	Mini	£6.45	£4.95	£5.94
FHLMIC215	Micro II	£7.65	£5.95	£7.14

Cable Ties - Packs of 100



- Ties manufactured from nylon 66 making them heat resistant over the temperature range -40°C to +85°C.

Model No.	Size	Colour	List Price	Exc. VAT	Inc. VAT
CT20048P100	200 x 4.8mm	Black	£4.35	£2.95	£3.54
CT20048P100W	200 x 4.8mm	White	£4.35	£2.95	£3.54
CT20048P100Y	200 x 4.4mm	Yellow	£4.35	£2.95	£3.54
CT20048P100R	200 x 4.4mm	Red	£4.35	£2.95	£3.54
CT20048P100G	200 x 4.4mm	Green	£4.35	£2.95	£3.54
CT20048P100B	200 x 4.4mm	Blue	£4.35	£2.95	£3.54

Heat Shrink Tubing Assortments Black



- Thin wall heat shrink tubes.
- RoHS compliant.
- Shrink Ratio: 2:1.

Model No. HST501B

Model No.	Qty	Lengths	Size (Approx. Quantity)	List Price	Exc. VAT	Inc. VAT
HST100B	95pc	100mm	Ø3.2 (x30), Ø4.8 (x40), Ø6.4 (x10), Ø9.5 (x10), Ø12.7mm (x5)	£13.45	£8.95	£10.74
HST501B	180pc	50, 100mm	50mm: Ø3.2 (x60), Ø4.8 (x40), Ø6.4mm (x20) 100mm: Ø3.2 (x30), Ø4.8 (x20), Ø6.4mm (x10)	£13.95	£9.95	£11.94

335pc Aluminium Rivet Assortment

NEW Product



- Standard and large flange.
- Quantity: 335.
- Sizes (Approximate Quantity): Standard Flange; Ø3.2 x 10 (x50), 4.8 x 13 (x65), 4.8 x 16.5 (x50), 4.8 x 19 (x50), 4.8 x 27 (x30), 6.4 x 18mm (x20); Large Flange; Ø4.8 x 13 (x30), 4.8 x 19mm (x40).
- Model No. AB079AR
- List Price £24.95

£19.95 Exc. VAT
£23.94 Inc. VAT

95pc 100mm Heat Shrink Tubing Assortment Black & Red



- Thin wall heat shrink tubes.
- RoHS compliant.
- Shrink Ratio: 2:1.
- Length: 100mm.
- Size (Approximate Quantity): Ø3.2 (x30), Ø4.8 (x40), Ø6.4 (x10), Ø9.5 (x10), Ø12.7mm (x5).
- Model No. HST100BR
- List Price £13.45

£8.95 Exc. VAT
£10.74 Inc. VAT

1L Pressure Sprayer with Viton® Seals

1L



- Suitable for use with most brake cleaners, detergents, traffic film removers, penetrating oils and weed killers.
- Viton® seals allow use with a wide range of semi volatile chemicals that would deteriorate standard seals.
- Adjustable nozzle enables a mist to jet pattern, which allows an easy and direct application of liquid exactly where it is required.
- Robust composite construction with a 1L capacity container.
- Model No. SCSG02
- List Price £23.95

£14.95 Exc. VAT
£17.94 Inc. VAT

200mm Heat Shrink Tubing - Packs of 100



Model No. HST200MC

- Thin wall heat shrink tubes.
- RoHS compliant.
- Shrink Ratio: 2:1.
- Length: 200mm.



All models supplied in a pack.

Model No.	Colour	Sizes (Approx. Quantity)	List Price	Exc. VAT	Inc. VAT
HST200B	Black	Ø3.2 (x30), Ø4.8 (x30), Ø6.4 (x20), Ø9.5 (x10), Ø12.7mm (x10)	£12.45	£7.95	£9.54
HST200BR	Black, Red	Ø3.2 (x30), Ø4.8 (x30), Ø6.4 (x20), Ø9.5 (x10), Ø12.7mm (x10)	£12.95	£7.95	£9.54
HST200MC	Black, Blue, Red, White, Yellow	Ø3.2 (x30), Ø4.8 (x30), Ø6.4 (x20), Ø9.5 (x10), Ø12.7mm (x10)	£13.45	£8.95	£10.74

Aluminium Silicate Blasting Media



NEW
Products

- General purpose abrasive, can be used on a wide variety of materials including ferrous metals, wood, stone and brickwork.
- Leaves less of a dark residue when blasting compared to other blast media.

Model No.	Size	Weight	List Price	Exc. VAT	Inc. VAT
ASF25KG	0.09-0.25mm	25kg	£34.95	£29.95	£35.94
ASM25KG	0.20-0.50mm	25kg	£34.95	£29.95	£35.94

150m Steering Wheel Protection Film with Applicator Handle

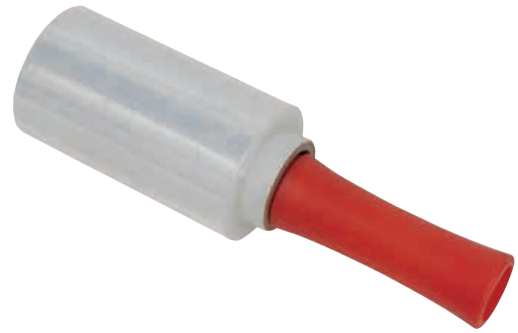

- Steering wheel protection film with applicator handle.
- 150m x 125mm Film.
- Comfort grip handle for easy and fast application.
- **Model No. SWPH150**
- List Price £12.45

£7.95 Exc. VAT
£9.54 Inc. VAT

19mm x 20m PVC Insulating Tape - Packs of 10

- RoHS Compliant insulating tape.
- Thickness: 0.15mm.
- Elongation: 125%.
- Tensile Strength: 22N/100mm.
- Temperature Rating: -18°C to 150°C.

Model No.	Colour	List Price	Exc. VAT	Inc. VAT
ITMIX10	Red, Black, White, Yellow, Blue (2 of each)	£14.45	£8.95	£10.74
ITRED10	Red	£14.45	£8.95	£10.74
ITBLK10	Black	£14.45	£8.95	£10.74
ITWHT10	White	£14.45	£8.95	£10.74
ITYEL10	Yellow	£14.45	£8.95	£10.74
ITBLU10	Blue	£14.45	£8.95	£10.74



80mm x 100m Non-Adhesive Hazard Warning Barrier Tape

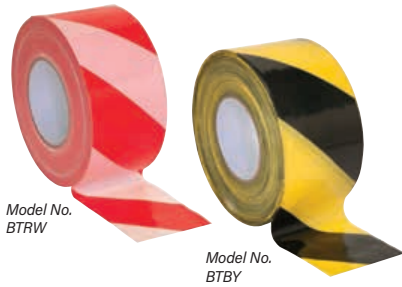

Model No. BTRW

Model No. BTBY

- Non-adhesive PE film.

Model No.	Colour	List Price	Exc. VAT	Inc. VAT
BTRW	Red/White	£5.75	£3.75	£4.50
BTBY	Black/Yellow	£5.75	£3.75	£4.50

50mm x 33m Hazard Warning Tape

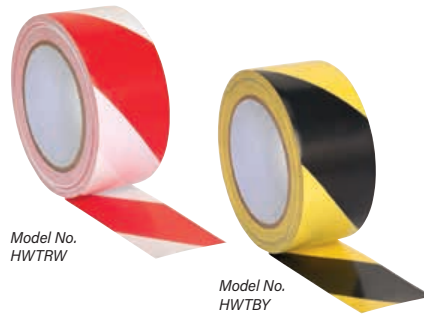

Model No. HWTRW

Model No. HWTBY

- Adhesive PVC film.

Model No.	Colour	List Price	Exc. VAT	Inc. VAT
HWTRW	Red/White	£4.75	£3.25	£3.90
HWTBY	Black/Yellow	£4.75	£3.25	£3.90

500ml Clear Multipurpose Fine Oil Lubricant



- Clear fine oil suitable for wire rope, chains, cables, hinges, springs and slides.
- Cleans, lubricates and protects against rust.
- General application for all types of machinery.
- Higher grade general-purpose lubricant, accurate and economical application.
- Anti-corrosive.
- **Model No. SCS019S**
- List Price £11.95

£6.95 Exc. VAT
£8.34 Inc. VAT

500ml Stone Chip Paint



- Outstanding covering power.
- Fast drying.
- Protects ferrous metals from corrosion.
- Adheres to metal and plastic surfaces.
- For use on sills, wheel arches and underbodies.
- **Model No. SCS060S**
- List Price £12.95

£8.95 Exc. VAT
£10.74 Inc. VAT

500ml Filler Primer Paint



- Outstanding covering power.
- Excellent adhesion to metal, rigid plastic and wood surfaces.
- High build primer fills small scratches and dents for a smooth finish.
- Use to prepare surfaces prior to top coating.
- **Model No. SCS061S**
- List Price £12.95

£8.95 Exc. VAT
£10.74 Inc. VAT

500ml Grey Etch Primer Paint



- Outstanding covering power.
- Maximum adhesion to metal surfaces.
- Protects ferrous metals from corroding.
- Use to prepare surfaces prior to top coating.
- **Model No. SCS062S**
- List Price £12.95

£8.95 Exc. VAT
£10.74 Inc. VAT

360° 4W & 3W SMD LED Rechargeable Inspection Lights



SMD LED

400 LUMENS

Magnetic



- Unique and innovative 360° swivel and tilt function enables the light source to be positioned in any direction.
- 4W SMD LED providing up to 400 lumens output with 120° spread of light.
- High power 3W LED directional torch.
- Features two swivel hooks and three rubber covered magnets for hands-free operation.
- High quality 2.2Ah lithium-ion battery.
- Micro USB charging port.
- Supplied with USB cable.
- Operating Time Side (High/Low)/Top: (3/7)/8hr.
- Charging Time: 3.5hr.
- Min./Max. Length: 255/270mm.



Model No.	Colour	List Price	Exc. VAT	Inc. VAT
LED3602R	Red	£49.95	£37.95	£45.54
LED3602G	Green	£49.95	£37.95	£45.54
LED3602	Black	£49.95	£37.95	£45.54
LED3602B	Blue	£49.95	£37.95	£45.54
LED3602Y	Yellow	£49.95	£37.95	£45.54



360° 8W & 1W SMD LED Rechargeable Inspection Lights



SMD LED

600 LUMENS

Magnetic



- Unique and innovative 360° swivel and tilt function enables the light source to be positioned in any direction.
- Exclusive patented design owned by and registered to SEALEY.
- Features super bright 8W SMD LEDs providing up to 600 lumens through the adjustable rotary switch and a 1W LED directional torch.
- Slimline design with minimum thickness of 9mm.
- Features a single hanging hook, magnetic base allowing hands-free operation and battery level indicator.
- High quality 3.7V 2.6Ah lithium-ion battery for longer life.
- Supplied with a high quality braided USB lead.
- Model No. LED3604UV includes a four LED UV light.

Model No.	Colour	UV End Light	List Price	Exc. VAT	Inc. VAT
LED3604R	Red	X	£59.95	£40.95	£49.14
LED3604G	Green	X	£59.95	£40.95	£49.14
LED3604	Black	X	£59.95	£40.95	£49.14
LED3604UV	Blue	✓	£69.95	£44.95	£53.94

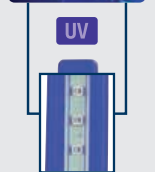
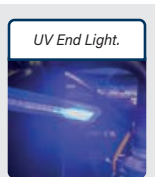

3W SMD LED Flexi Rechargeable Magnetic Pick-Up Tool Light

SMD LED

280 LUMENS

Magnetic



- High power 3W SMD LED produces up to 280 lumens in tight spaces like engine compartments.
- Features a 300mm heavy-duty flexible neck with the ability to hold its position wherever you need it.
- Magnetic ring around light for use as a pick-up tool.
- Features a magnetic base with an adjustable hook for storage.
- On/off switch controls two lighting options.
- Supplied with USB Type-C Cable.
- Over charge and over discharge protection.
- **Model No. LEDFLEXPT**
- List Price £34.95

£24.95 Exc. VAT
£29.94 Inc. VAT

SEE OUR NEW LEDFLEX ADD-ONS BELOW

NEW
Products

LED Pick-Up Tool Mirrors

- Useful addition to the Sealey Flexi LED Pick-up Tool - LEDFLEXPT.
- Suitable for use in low-lit and confined spaces.
- Clip-on feature saves time over conventional threaded attachments.
- Mirrors can rotate 360° and be angled on different axis through more than 180°.
- Can be angled to redirect the torch beam into inaccessible areas.



Model No. LEDFLEXPT & LEDFLEXM2

Model No.	Mirror Type	List Price	Exc. VAT	Inc. VAT
LEDFLEXM1	49 x 26mm - Narrow	£3.95	£2.95	£3.54
LEDFLEXM2	Ø51mm - Round	£4.95	£3.95	£4.74



Model No. LEDFLEXPT & LEDFLEXM1



Model No. LEDFLEXPT & LEDFLEXM1

3W COB LED Aluminium Mini Hand Torch

COB LED

500 LUMENS

Magnetic



- Side-mounted push-button to switch between two brightness settings of 100 or 300 lumens.
- Press and hold button for 500 lumens super beam.
- Features a magnet on the end, along with a metal belt clip on the back for hands-free operation.
- Battery: 3.7V 600mAh lithium-ion.
- Charging Time: 2.5hr.
- Operating Time (High/Low): 1.5/3hr.
- Micro USB charging port.
- Supplied with charging lead.
- **Model No. LED500SB**
- List Price £22.45

£16.95 Exc. VAT
£20.34 Inc. VAT

30W COB LED Rechargeable Portable Floodlight & Power Bank

30W COB LED

3000 LUMENS



- 30W COB LED Compact portable floodlight.
- Three modes of light ranging from 300-3000lm.
- Rechargeable high quality 3.7V battery.
- 180° Curve for a wide spread of light.
- Adjustable stand for positioning of light.
- Supplied with 500mm Type-C USB Charging cable.
- Charging Time: 8.5hr.
- Water (IPX5) and Impact (1M) resistant.
- Power Bank Output: 5V=1A.
- **Model No. LED3000**
- List Price £49.95

£36.95 Exc. VAT
£44.34 Inc. VAT

13W SMD LED Rechargeable Under-Bonnet Light

SMD LED

1200 LUMENS

Magnetic



- Rechargeable Under-Bonnet 1200 Lumen SMD LED worklight with three brightness settings.
- 180° Swivel handle for adjustable lighting angle.
- Each end has a 360° swivel/hanging hook and a magnet.
- 3.7V 4.4Ah Lithium-ion battery.
- 1.8m USB charging cable.
- Includes LED charge indicator.
- Max. 4hr run time.
- **Model No. LED139**
- List Price £58.95



£46.95 Exc. VAT
£56.34 Inc. VAT

3W COB & 1W SMD LED Rechargeable Aluminium Pocket Light with UV

COB LED

SMD LED

220 LUMENS

Magnetic

Ultraviolet



- Powerful 3W COB with 1W SMD and 2 x UV SMD.
- USB rechargeable lithium-ion battery with small green/red charging indicator light.
- Made from aluminium, anodized and finished with rubber coating for a more premium feel.
- A strong magnet in the pocket/belt clip allows for hands-free use as well as a second strong magnet in the base.
- Two longwave UV-A SMDs at 390-400nm.
- Lumen Output: 220lm.
- Battery: 3.7V 2.2Ah.
- Charging Time: 3hr.
- **Model No. LED220UV**
- List Price £29.95

£17.95 Exc. VAT
£21.54 Inc. VAT

3W COB & 2W SMD LED Rechargeable Inspection Light

COB LED

SMD LED

NEW Product

200 LUMENS

Magnetic



- Lightweight light featuring a super bright 3W COB LED, which gives an even and constant spread of light, producing up to 200 lumens.
- 2W High power SMD LED torch producing up to 100 lumens.
- Integral hanging hook/belt clip and a magnetic base which can rotate through 180° for hands-free applications.
- Rechargeable 3.7V 1.2Ah lithium-ion battery for longer product life.
- Operating Time: 2-4hr.
- Charging Time: 4hr.
- Supplied with 300mm USB TYPE-C charging cable.
- **Model No. LED301**
- List Price £14.95

£11.95 Exc. VAT
£14.34 Inc. VAT

10W COB LED Rechargeable Pocket Floodlight with Power Bank

COB LED

UP TO 1000 LUMENS

Magnetic



- Compact, lightweight design with a massive 1000lm output.
- Made with a tough ABS plastic housing with flip-out magnetic bracket that hides a small carabiner, which can be used when no ferrous surface is available.
- Includes USB 5V=1A output for secondary use as a power bank.
- Magnetic bracket can be angled at a range of 120°.
- Three light output settings; full 1000lm, half 500lm and flashing.
- Features LED battery level indicator.
- Fitted with a high quality 3.7V 4.5Ah lithium-ion battery.
- Operating Time: 4hr.
- Charging Time: 3.5hr.
- Charges via a Micro USB lead. (Supplied with micro USB cable).
- **Model No. LED1000PB**
- List Price £29.95

£20.95 Exc. VAT
£25.14 Inc. VAT

24W SMD LED Super Beam Rechargeable Pocket Light

NEW Product

24W **SMD LED**

2500 LUMENS Magnetic

FOUR MODES OF LIGHT; LOW, MEDIUM, HIGH AND SUPER BEAM MODE.

POWERFUL 24W TORCH WITH 2500LM OUTPUT.

INTELLIGENT LED CHARGING INDICATOR.

LIGHTWEIGHT ALUMINIUM HOUSING.

- Convenient small pocket size for easy transportation.
- Rechargeable battery with 2hr charge time (supplied with 500mm USB-C charging cable).
- Includes strong magnet on the base to aid hands-free use.
- Impact resistance: 1M.
- Dust/water resistance: IP44.
- **Model No. LED2500SB**
- List Price £29.95



£22.95 Exc. VAT
£27.54 Inc. VAT

10W Portable Power Banks

10W **10000mAh** OR **20000mAh**

- Pocket-size ideal for charging mobile phones whilst on the go.
- Suitable for both Micro USB and Type-C input cables (Type-C Cable not included).
- Includes built-in Li-poly battery and battery level indicator.
- Supplied with Micro USB Charging cable.



Model No. SPB101



Model No. SPB102



Model No. SPB102

Phone not included.

Model No.	Capacity	List Price	Exc. VAT	Inc. VAT
SPB101	10,000mAh	£21.95	£17.95	£21.54
SPB102	20,000mAh	£33.95	£27.95	£33.54

SMD LED Extra-Slim Solar Floodlights with Wall Bracket

SMD LED

Solar Powered

Model No. LED20S

20W

2000 LUMENS



Model No. LED30S

30W

3000 LUMENS



- Extra-Slim Solar floodlight with wall bracket.
- Solar panels with high quality ETFE solar panel glass cover for improved longevity.
- Features both daylight (CDS) and motion (PIR) sensors to switch on automatically.
- Motion sensor can detect up to 6m.
- Model No. LED20S has an extra-slim ABS housing with steel wall bracket and a 3.7V Lithium-ion battery with a 3Ah capacity.
- Model No. LED30S has an extra-slim aluminium die casting housing with steel wall bracket and has two 3.7V Lithium-ion batteries with a capacity of 2.6Ah each.
- Run time of 10hr and has a 30sec timer upon sensing motion.
- All year-round solar charging regardless of cloud cover.

Model No.	LED Type	Lumen Output	Solar Panel	List Price	Exc. VAT	Inc. VAT
LED20S	20W SMD	2000	2W	£29.95	£21.95	£26.34
LED30S	30W SMD	3000	4W	£49.95	£36.95	£44.34

115Wh Lithium AC Power Pack 160W

USB



160W



Laptop not included.



- Easily fits in a glove box or backpack, weighing 1.5kg.
- Multiple high amperage outputs, fitted with a 115Wh battery.
- This unit can also supply multiple full charges to both smartphones and tablets.
- Fully charges in 8 hours on USB Type-C.
- Inputs: QC3.0 (1 x Micro USB, 1 x TYPE-C, both cables included).
- Outputs: 230V~50HZ AC, 2 x 12V 10A DC Outputs (120W MAX.), Standard USB 5V=2A, QC3.0 (5V=2A, 9V=2A, 12V=1.5A), Type-C Output (5V=2A).
- **Model No. SPB160W**
- List Price £189.95

£149.95 Exc. VAT
£179.94 Inc. VAT

2200W Portable Power Station

NEW Product 2200W

- LiFePO4 battery can be charged and discharged 3000 times before it starts to lose performance.
- The power station is capable of charging an average phone battery over 100 times or supplying power to a car fridge for 12hrs (based on a 60W Continuous draw).
- 12 Different outlets mean you are able to connect up to 12 devices at once.
- Integral light with five different modes; high, medium, low, flashing and SOS.
- Supplied with smart jump cables so the power station can be used to jump start a vehicle.
- There are eight forms of built-in protection including; over-charge, short-circuit, reverse polarity, temperature protection and more.
- Includes battery link cable which allows you to expand the unit's capacity with additional power stations.
- Audible alarm will sound at 10% battery power to help make sure you never run out of battery.
- The power station will charge to full in 8hrs.
- Supplied with AC-DC transformer charger and 12V DC auxiliary car charger.
- **Model No. SPB2200W**
- List Price £1,299.95



£999.95 Exc. VAT
£1,199.94 Inc. VAT

Bench Mounting Saw Blade Sharpener



- Free Speed: 5300rpm.
- Suitable for sharpening TCT saw blades in range from Ø90-400mm.
- Fitted with a Ø100mm diamond coated grinding disc for optimising TCT saw blade performance.
- Supplied with optional ceramic disc for non TCT blades.
- Precision 0-25° angle adjustment allowing each tip to be sharpened exactly the same.
- **Model No. SMS2003**
- List Price £124.95

£99.95 Exc. VAT
£119.94 Inc. VAT

Ø150mm Heavy-Duty Bench Grinder with Wire Wheel 450W

Ø150mm Stone Ø150mm Wire Wheel Induction Motor



HEAVY DUTY

- Fitted with copper wound induction motor drive.
- Suitable for general workshop grinding/sharpening and descaling/cleaning use.
- One coarse aluminous oxide grinding stone and one wire wheel.
- Fitted with stone guards and spark arrestors.
- Eye shields included.
- Supplied with 3-pin plug.
- **Model No. BG150XW/99**
- List Price £194.95

£139.95 Exc. VAT
£167.94 Inc. VAT

Ø200mm Heavy-Duty Bench Grinder 600W

Ø200mm Stone Induction Motor



HEAVY DUTY

- Fitted with copper wound induction motor drive.
- Suitable for general workshop grinding and sharpening use.
- Two aluminous oxide grinding stones, coarse and fine.
- Fitted with stone guards and spark arrestors.
- Eye shields included.
- Supplied with 3-pin plug.
- **Model No. BG200/99**
- List Price £269.95

£189.95 Exc. VAT
£227.94 Inc. VAT

Oscillating Spindle/Bobbin Sander 450W



- For all types of curved sanding both in deep and wide workpieces.
- All sanding parts and accessories have allocated slots in the housing for storage.
- A vacuum hose can be attached to the back of the spindle for dust extraction.
- Includes six sanding sleeves, five bobbin drums and six table inserts.
- Bobbin sizes range from 13-76mm.
- Oscillating speed 60/min. Spindle speed 2057rpm.
- Supplied with a 2m mains cable.
- **Model No. SM1200**
- List Price £124.95

£119.95 Exc. VAT
£143.94 Inc. VAT

915 x 100mm Belt/Ø150mm Disc Sander 370W

915 x 100mm Belt

Ø150mm Disc



- Bench mounting semi-portable belt and disc sander suitable for general woodworking applications.
- Powerful induction motor with smooth, bearing-mounted drive pulleys gives quiet operation.
- The sanding belt can be used in a vertical or horizontal position or at any other angle in between.
- The sanding disc table can be tilted to any angle up to 45° and is supplied with a mitre gauge for accurate angle sanding.
- **Model No. SM914**
- List Price £199.95

£139.95 Exc. VAT
£167.94 Inc. VAT

25mm x 762mm Belt/Ø125mm Disc Sander

25 x 762mm Belt

Ø125mm Disc



- Bench mounting semi-portable belt and disc sander suitable for general woodworking applications.
- Powerful induction motor with smooth, bearing-mounted drive pulleys gives quiet operation.
- 250W/230V Induction motor.
- Sanding disc table tilts to 45° and is supplied with mitre gauge for accurate angle sanding.
- Sanding belt is positioned vertically.
- **Model No. SM750**
- List Price £109.95

£79.95 Exc. VAT
£95.94 Inc. VAT

35mm Magnetic Drilling Machines



- Lightweight and compact units made from heavy-duty die-cast magnesium alloy.
- Fitted with a powerful magnet to ensure unit stays adhered at any angle.
- Includes safety fixing strap, 10mm twist drill chuck and integrated coolant system to extend the life of cutters and increase the quality of the cut.
- Designed for use in fabrication, construction and other applications when drilling ferrous metal.
- **Model No. MAG110V - 110V**
- **Model No. MAG230V - 230V**
- List Price £499.95

Magnetic

Model No. MAG110V



£379.95 Exc. VAT
£455.94 Inc. VAT



**SCAN TO
DISCOVER
OUR
COMPLETE
RANGE OF
PILLAR
DRILLS**

5-Speed Pillar Drill 350W

- 5-Speed
- 13mm
- 350W



- 13mm (1/2") Capacity chuck.
- Compact bench drill powerful enough to cut through wood, plastic and metal.
- Easy to operate, smooth and quiet in operation.
- 5-Speed settings between 580 and 2650rpm.
- Safety is ensured by protection guard and no-volt safety switch.
- Height: 580mm.
- Chuck to Column: 104mm.
- Motor Power: 185W, Input Power: 350W.
- Column Diameter: Ø46mm.
- Spindle Travel: 50mm.
- Weight: 15.2kg.
- **Model No. SDM30**
- List Price £149.95

£109.95 Exc. VAT
£131.94 Inc. VAT

1/2" Hollow Chisel Mortiser



- Bench mounting mortising machine suitable for cutting mortises for joints and also for locks and dead-bolts.
- No-volt release switch to prevent accidental restart after power failure or jam.
- Includes table, workpiece clamp and mortising chisel and chuck for standard drill bits.
- Recommended height of work item is at least 55mm for secure placement in clamp.
- **Model No. SM94**
- List Price £299.95

£239.95 Exc. VAT
£287.94 Inc. VAT

Premier Pillar Drills



3 YEAR GUARANTEE*

- 12-Speed OR 16mm
- 16-Speed OR 20mm

Worklight

Model No's PDM155B, PDM210F, PDM240F and PDM260F are fitted with an integral worklight which illuminates the drilling table.



Model No. PDM125B



Model No. PDM170F

75+ KG HEAVY ITEM
PDM240F and PDM260F are heavy. Extra assistance must be provided at the delivery point to help safe delivery.

- Models feature heavy-duty aluminium-bodied motors for long and reliable performance.
- No-volt release switch to prevent inadvertent start-up and pulley cover protected by microswitch to prevent drill operating when cover is open.
- All models supplied with an electrically interlocked chuck guard.
- Large sized square tables fitted with precision rack and pinion height adjustment.

720W Bench Pillar Drill with Digital Display & Laser

- 720W 13mm 2-Speed **LED**



- Great workspace illumination and accuracy thanks to the integrated LED light and laser.
- Easy-to-read LCD display shows rpm as well as spindle travel for exact drilling depth (maximum 100mm stroke).
- Superior control from two gears giving speed adjustment from 170 to 880rpm and 490 to 2600rpm.
- Convenient quick release 1.5 to 13mm chuck.
- Maximum throat distance is 280mm.
- Wide (300 x 330mm) aluminium base gives increased stability and is corrosion free.
- Integrated laser for easy and precise drilling.
- Integrated LED for perfect illumination.
- Digital display for accurate drilling.
- **Model No. PDM10B**
- List Price £199.95

£169.95 Exc. VAT
£203.94 Inc. VAT

Model No.	Type	Spindle Centre to Column	No. of Speeds	Speed Range	Column Diameter	Collar Diameter	Motor Power (Start)	Weight	List Price	Exc. VAT	Inc. VAT
PDM125B	Bench	165mm	16	190-3000rpm	Ø73mm	Ø55mm	370W(600W)	45kg	£549.95	£409.95	£491.94
PDM155B	Bench	190mm	16	190-3000rpm	Ø80mm	Ø60mm	370W(600W)	55kg	£619.95	£459.95	£551.94
PDM170F	Floor	170mm	16	190-3000rpm	Ø73mm	Ø55mm	370W(600W)	47kg	£599.95	£409.95	£491.94
PDM210F	Floor	190mm	16	190-3000rpm	Ø80mm	Ø60mm	370W(600W)	62kg	£699.95	£519.95	£623.94
PDM240F	Floor	216mm	16	160-3000rpm	Ø80mm	Ø75mm	750W(1000W)	76kg	£899.95	£649.95	£779.94
PDM260F	Floor	260mm	12	120-3480rpm	Ø92mm	Ø85mm	1100W(1500W)	110kg	£1,299.95	£999.95	£1,199.94

406mm Throat Variable Speed Scroll Saw

406mm **VARIABLE SPEED**



- Quality cast rounded table, suitable for precise and intricate cutting.
- Features parallel arm design and quick blade changing system.
- Variable speed operation to cut multiple types of material.
- Fitted with adjustable safety guard.
- Flexible dust blower to keep a dust-free work area.
- Supplied with a pinned blade.
- **Model No. SM1302**
- List Price £139.95

£99.95 Exc. VAT
£119.94 Inc. VAT

Ø255mm Sliding Compound Mitre Saw

Ø255mm

2000W

ASER GUIDE



- Powerful 2000W motor.
- Features integral aluminium workpiece supports which store inside the aluminium base to save space and prevent loss.
- Fitted with a 40-tooth TCT blade for fresh wood.
- Can be fitted with Model No. SMS255B multipurpose blade for use with mild steel, aluminium and wood with nails.
- Features double slides which can be locked at different lengths allowing greater control over the desired length of cut.
- Max. Cut of up to 315mm at 0° bevel.
- Unit is also fitted with a laser guide to help produce accurate cuts.
- Supplied with workpiece clamp, dust extraction bag and fitted with carry handle.
- Features locking increments at mitre stops 0°, 15°, 22.5°, 31.6°, 45° Left and Right.
- Cross Cut (0° Bevel x 0° Table): 90 x 315mm.
- Mitre Cut (0° Bevel x 45° Table): 90 x 215mm.
- Bevel Cut (45° Bevel x 0° Table): 40 x 215mm.
- **Model No. SMS255**
- List Price £249.95

£139.95 Exc. VAT
£167.94 Inc. VAT



150mm Capacity

150mm 3-Speed Metal Cutting Bandsaw with Quick Lock Vice & Stand



Stand Included

Professional Bandsaws



Model No. SM1303
200mm



- Dust Extraction Diameter: Ø40mm.
- Steel chassis with locking blade wheel covers.
- Suitable for cutting wood and plastics.
- Fitted with blade wheel brush to prevent dust accumulation.
- Bearing-mounted blade wheels and direct drive induction motor provide smooth operation.
- Features rip fence, mitre gauge and push stick.



Model No. SM1304

245mm

Stand Included

Model No.	Throat Depth	Max. Cutting Height	List Price	Exc. VAT	Inc. VAT
SM1303	200mm	80mm	£149.95	£124.95	£149.94
SM1304	245mm	100mm	£299.95	£239.95	£287.94

Ø355mm Cut-Off Machines

2480W

Model No. SM355B

Ø355mm

- TCT blade cuts slow and cold without the need for coolant fluid.
- Will handle steel, wood, brass, aluminium and most plastics, without the need to change blades.
- Even hidden nails and screws in timber are no longer a problem.
- Cast alloy base for added strength, while retaining portability.
- Features heavy-duty saw arm and quick action mitring vice.
- Fully guarded and fitted with a dead man's trigger control to prevent accidental starting.
- Motor: 2480W.
- Weight: 21kg.

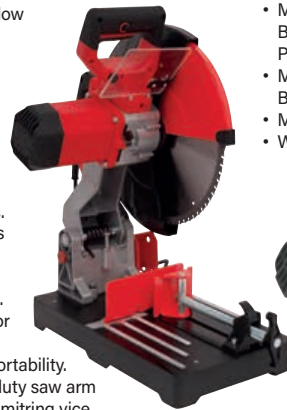

Model No. SM355D

Ø355mm

Model No.	No-Load Speed	Disc	Disc Type	List Price	Exc. VAT	Inc. VAT
SM355B	1450rpm	SM355B72	Blade	£569.95	£429.95	£515.94
SM355D	3800rpm	PTC/355C	Abrasive	£269.95	£189.95	£227.94

- Swivel cutting arm saves space when cutting angled work, ideal for the smaller workspace or engineer's shop which is short on space.
- Professional type quick-grip vice included as standard - put the work on the vice, push the jaw up to the workpiece, then pull the cam-action lever to lock.
- Benchtop mounting on anti-vibration feet and oil bath gearbox for smooth running and long-life.
- Roller bearing blade guides for precision cutting.
- **Model No. SM65**
- List Price £649.95

£479.95 Exc. VAT
£575.94 Inc. VAT

Bench Mounting Metal Bender



- Manually operated, bench mounting metal bender.
- Radiused and angled bends in strips up to 50mm wide.
- Radiused bends in round/square stock up to 16mm diameter/side.
- Supplied with seven dies, 1" to 3".
- **Model No. PBB04**
- List Price £164.95

£129.95 Exc. VAT
£155.94 Inc. VAT

Floor Mounting Metal Bender



- Manually operated, floor mounting metal bender.
- Radiused and angled bends in strips up to 50mm wide.
- Radiused bends in round or square stock up to 16mm thickness.
- Supplied with seven dies, 1" to 3".
- **Model No. PBF04**
- List Price £239.95

£189.95 Exc. VAT
£227.94 Inc. VAT

9 Tonne Industrial Hydraulic Pipe Bender with Stand

9 Tonne Capacity Maximum
Capacity Ø50mm



2 SPEED PUMP



- Tripod mounted pipe bender suitable for bending pipes up to 180°.
- Integral 9 Tonne ram.
- Suitable for bending DIN classified medium and heavy pipe.
- 2-Speed hydraulic pump gives fast pipe positioning and the power to bend 50mm pipe.
- Supplied with six (15mm(1/2") - 50mm(2")) interchangeable dies.
- Packed in a heavy wooden crate for easy transportation.
- **Model No. PBS90**
- List Price £559.95

£469.95 Exc. VAT
£563.94 Inc. VAT

Ø254mm Table Saw



Ø254mm
1500W



- Powder coated aluminium table with one rear and two side extension tables.
- Supplied with 40-tooth TCT blade and 1500W motor.
- Cutting capacity: 80mm at 90° and 55mm at 45°.
- Includes quick lock rip-fence, mitre gauge, dust extraction port, push stick and sturdy metal stand.
- Fitted with 3-pin plug.
- **Model No. TS10P**
- List Price £229.95

Supplied with
Stand & Extension
Tables

£149.95 Exc. VAT
£179.94 Inc. VAT

Metalworking Lathe 300mm Between Centres

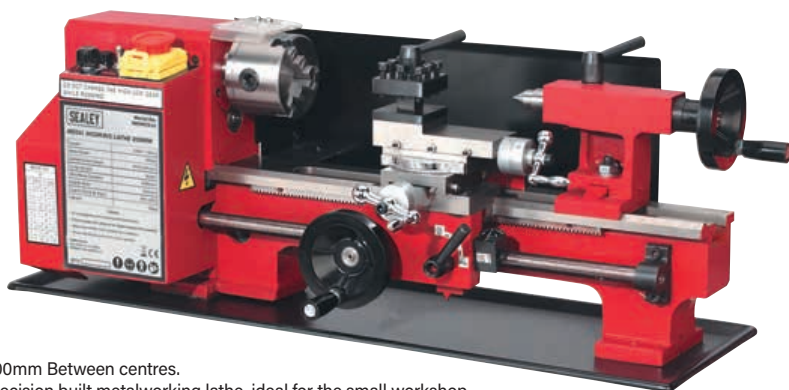

- 300mm Between centres.
- Precision built metalworking lathe, ideal for the small workshop, professional or home engineer and model maker.
- Powered by a 300W motor this compact unit features variable speed reversible drive and powered cutting facility for right and left-hand threads.
- Supplied with self-centring 3-jaw chuck, 4-way tool post, swarf tray and rear splash guard.
- Supplied with emergency stop button and chuck guard.
- Optional stand is available, order Model No. SM3002ST.
- **Model No. SM3002**
- List Price £1,169.95

£999.95 Exc. VAT
£1,199.94 Inc. VAT

Steady Rests for SM3002

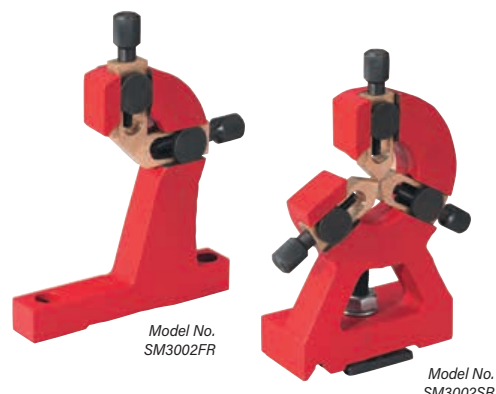

- Comprehensive ranges of high quality accessories for Model No. SM3002 metalworking lathe.

Model No.	Type	List Price	Exc. VAT	Inc. VAT
SM3002FR	Moving Steady Rest	£42.95	£39.95	£47.94
SM3002SR	Fixed Steady Rest	£57.95	£52.95	£63.54

Mini Drilling/Milling Machine



- Bench mounting machine with the flexibility to handle most materials.
- Features include a 350W motor, variable speed drive, working table with T-slots to enable clamping of workpieces and metric graduated compound scales.
- Incorporates a tilting column which allows drilling/milling of workpiece at $\pm 45^\circ$ from vertical.
- Supplied with 13mm chuck and accessory kit for adjusting and setting.
- An optional stand is available, order Model No. SM3002ST.
- **Model No. SM2502**
- List Price £1,299.95

£999.95 Exc. VAT
£1,199.94 Inc. VAT

Stand for SM3002, SM2502, SM2503



- One of a comprehensive range of high quality accessories for Model No's SM3002, SM2502 and SM2503 metalworking lathes.
- Overall Size (W x D x H): 800 x 355 x 880mm.
- **Model No. SM3002ST**
- List Price £134.95

£119.95 Exc. VAT
£143.94 Inc. VAT

Mini Lathe & Drilling Machine



- Bench mounting multifunction mini drill, mill and lathe with variable speed giving flexibility to handle most materials.
- Features two 150W motors, one to operate the drill/mill and the other to power the lathe.
- The lathe cutting feed can be power driven or advanced manually.
- Thread cutting may also be undertaken with the optional thread cutting kit.
- Supplied with Metric graduated scales and all necessary tools required for setting and adjusting.
- Complies with Machinery Directive and is fully CE approved.
- Optional stand available, order Model No. SM3002ST.
- **Model No. SM2503**
- List Price £1,399.95

£1,129.95 Exc. VAT
£1,355.94 Inc. VAT

Steady Rests for SM2503

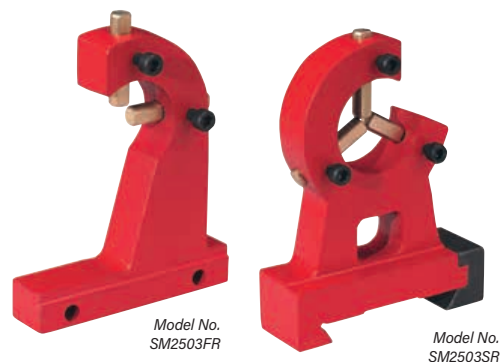

- Comprehensive ranges of high quality accessories for Model No. SM2503 mini lathe/drilling machine.

Model No.	Type	List Price	Exc. VAT	Inc. VAT
SM2503FR	Moving Steady Rest	£42.95	£39.95	£47.94
SM2503SR	Fixed Steady Rest	£54.95	£49.95	£59.94

28pc Tap & Drill Bit Set - Metric

NEW Product **MM**

- Comprehensive set suitable for both drilling and tapping.
- Manufactured from high quality alloy steel.
- Stored in a portable steel storage case with internal organisers.
- Contents: 7 x Taps (Taper, secondary and bottoming): 3 x 0.5, 4 x 0.7, 5 x 0.8, 6 x 1.0, 8 x 1.25, 10 x 1.5, 12 x 1.75,
- 7 x Metric HSS drill bits: 2.5, 3.3, 4.2, 5.0, 6.8, 8.5, 10.2mm.
- **Model No. AK3023**
- List Price £49.95

£34.95 Exc. VAT
£41.94 Inc. VAT



Universal External Thread Restorer/Chaser Metric/Imperial

Premier

MM & IMP

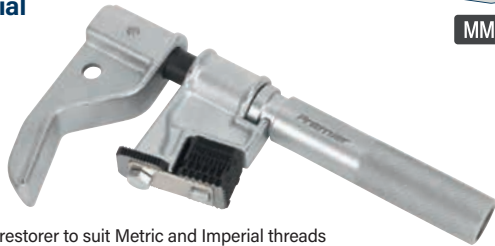

- Adjustable thread restorer to suit Metric and Imperial threads from Ø31.75-127mm(1-1/4"-5") external diameter.
- Simply attach to undamaged section of thread, then wind back the thread with the knurled adjuster and the chaser will restore the damaged thread section.
- Built-in storage for six dies.
- **Model No. AK315**
- List Price £159.95

£114.95 Exc. VAT
£137.94 Inc. VAT

50mm Portable Bench & Table Vice with 360° Swivel Base

- Portable vice, ideal for home, workshop and professional use. Perfect for woodworking, sawing, drilling, metalworking, sanding or planing.
- 360° Swivel base, perfect for a wide range of clamping angles. Rotate the vice into the perfect position to work on.
- Bench clamp, making it quick and easy to install and remove from any workbench. Can be used both indoors and outdoors.
- 50mm vice opening and 50mm wide jaw.
- **Model No. CV50**
- List Price £32.95



£18.95 Exc. VAT
£22.74 Inc. VAT

150mm Cast Iron Multifunction Swivel Base Vice

2 YEAR GUARANTEE*

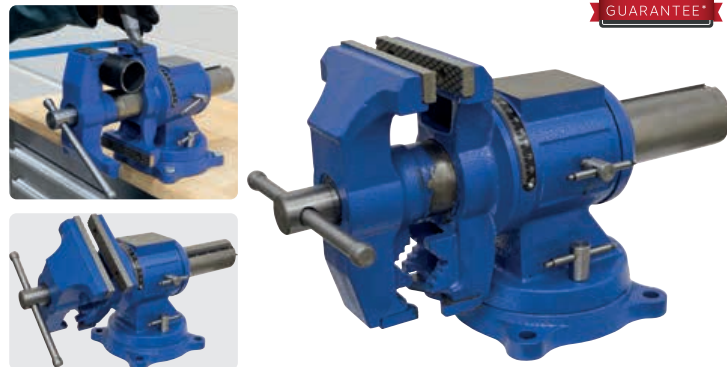

- Bench mounting vice with cast iron body and replaceable, diamond pattern face jaws.
- Features a 360° moving body and swivel base.
- A choice of 3-jaws: straight jaws, pipe jaws or V-jaws.
- Includes a large anvil and two scale rulers for accurate work.
- Suitable for workshop, garage and machine shop use.
- Jaw Opening: 125mm.
- Jaw Width: 150mm.
- 2 Year guarantee* against breakage.
- **Model No. MFV150**
- List Price £249.95

£179.95 Exc. VAT
£215.94 Inc. VAT

60pc Tap & Die Set - Metric & Imperial

Split Dies **MM & IMP**



- High quality alloy steel taps and dies.
- Split dies with machined lead-ins for ease of use.
- Die holder features self-centring mechanism for straight and accurate thread cutting.
- Contents: Taps and Dies; 3 x 0.5, 4 x 0.7, 5 x 0.8, 6 x 1.0, 7 x 1.0, 8 x 1.25, 9 x 1.25, 10 x 1.5, 10 x 1, 12 x 1.75mm, 4-40, 6-32, 8-32, 10-24, 10-32, 12-24, 1/4"-20, 1/4"-28, 5/16"-18, 5/16"-24, 3/8"-16, 3/8"-24, 7/16"-14, 7/16"-20, 1/2"-13, 1/2"-20, 1/8"-27, Die Handle, Double End Tap Wrench, T-handled Tap Wrench, Metric Screw Pitch Gauge, Imperial Screw Pitch Gauge and slotted 5mm Screwdriver.
- Supplied in heavy-duty storage case.
- **Model No. AK3060**
- List Price £103.95

£69.95 Exc. VAT
£83.94 Inc. VAT

Folding Workbench - 235mm Capacity



- Multifunctional worktop.
- Quick and easy-to-use.
- Strong construction.
- Handy tool storage on fold flat legs.
- Working height: 785mm.
- Width: 605mm.
- Simple to assemble.
- **Model No. FWB1**
- List Price £41.95

£24.95 Exc. VAT
£29.94 Inc. VAT

8pc Brass Pin Punch Set

MM & IMP



- Used for non-marring applications.
- Sizes: 1/16"/1.6mm, 3/32"/2.4mm, 1/8"/3.2mm, 5/32"/4mm, 3/16"/4.8mm, 7/32"/5.5mm, 1/4"/6.4mm, 5/16"/8mm.
- Supplied in pouch.
- Overall length 89mm.
- **Model No. AKB08**
- List Price £24.95

£19.95 Exc. VAT
£23.94 Inc. VAT

14pc All-Purpose Punch Set

MM & IMP



- Includes: 5-Piece Long Drive Pin Punch Set, Automatic Centre Punch, 8-Piece Brass Drive Pin Punch Set.
- Brass Punch Set Sizes: 1/16"/1.6mm, 3/32"/2.4mm, 1/8"/3.2mm, 5/32"/4mm, 3/16"/4.8mm, 7/32"/5.5mm, 1/4"/6.4mm, 5/16"/8mm.
- Long Drive Punch Sizes: 1/8"/3.2mm, 3/16"/4.8mm, 1/4"/6.3mm, 5/16"/8mm, 3/8"/9.5mm.
- Automatic Centre Punch length: 125mm.
- Supplied in a plastic pouch.
- **Model No. AKB14**
- List Price £34.95

£29.95 Exc. VAT
£35.94 Inc. VAT

5pc Brass Punch Set

MM & IMP

NEW
Product



- Ideal for the professional where a precise and accurate pin drive is required.
- Each punch has a slightly different size each end - one metric and other imperial.
- Brass is ideal where a non-marring application is needed.
- Sizes: 1/4"/6mm, 3/8"/10mm, 1/2"/13mm, 5/8"/16mm, 3/4"/19mm.
- Knurled grip for greater precision and control.
- **Model No. AKB05**
- List Price £59.95

£47.95 Exc. VAT
£57.54 Inc. VAT

File Cleaning Brush

- Ideal for cleaning woodwork rasps and metalwork files.
- Removes material shavings and swarf from file teeth quickly.
- 20cm Wooden handle with metal file card.
- **Model No. FB01**
- List Price £4.95



£3.95 Exc. VAT
£4.74 Inc. VAT

Rasp File Sets

Premier

LIFETIME GUARANTEE

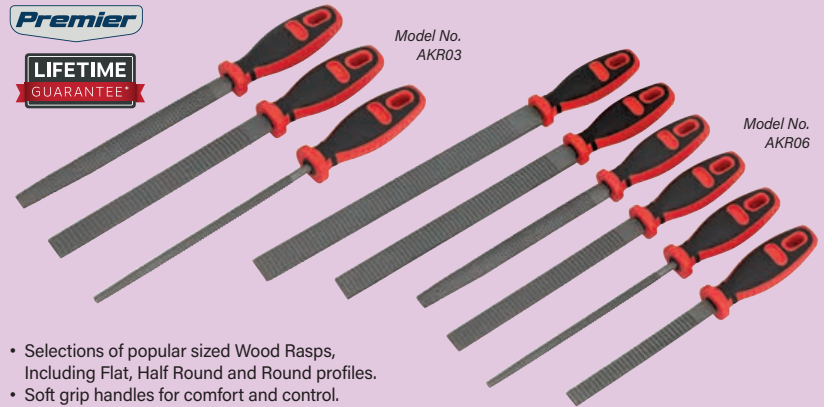

- Selections of popular sized Wood Rasps, Including Flat, Half Round and Round profiles.
- Soft grip handles for comfort and control.

Model No.	Qty	Contents	List Price	Exc. VAT	Inc. VAT
AKR03	3pc	200mm Flat Rasp, 200mm Round Rasp, 200mm Half Round Rasp	£14.95	£9.95	£11.94
AKR06	6pc	200mm Flat Rasp, 200mm Round Rasp, 200mm Half Round Rasp, 150mm Flat Rasp, 250mm Flat Rasp, 300mm Flat Rasp	£29.95	£21.95	£26.34

2pc Impact Stud Extractor Set

3/8" & 1/2" Sq Drive



- For use with 1/2" Sq and 3/8" Sq Drive impact wrenches.
- Fits studs from 6-12mm (1/4"-1/2").
- Carbon Steel casing with Chrome Molybdenum jaws.
- **Model No. AK7182**
- List Price £51.95

£34.95 Exc. VAT
£41.94 Inc. VAT

26pc Nut & Bolt Thread Checker - Metric/Imperial

MM & IMP

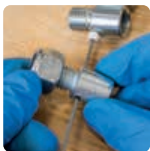

- Easily identify nut and bolt sizes in Imperial (14-piece) or Metric (12-piece).
- Thread checkers on a wire lanyard for quick and precise measuring.
- White beads between gauges to indicate the Metric sizes and blue to indicate Imperial.
- Convenient loops on each end for hanging.
- Imperial Sizes UNC/UNF: 6-32, 8-32, 10-24, 10-32, 1/4"-20, 1/4"-28, 5/16"-18, 5/16"-24, 3/8"-16, 3/8"-24, 7/16"-14, 7/16"-20, 1/2"-13, 1/2"-20.
- Metric Sizes: M4-0.7, M5-0.8, M6-1, M7-1, M8-1.25, M10-1, M10-1.25, M10-1.5, M12-1.25, M12-1.5, M12-1.75.
- **Model No. AK70NBC**
- List Price £32.95

£22.95 Exc. VAT
£27.54 Inc. VAT

6pc Telescopic Bore Gauge Set



- For measuring bore diameter.
- Spring loaded plunger expands within the bore which is then locked.
- The plunger can then be removed and measured with a micrometer.
- Satin chrome finish.
- Range: 8-150mm (5/16"-6").
- Supplied in wallet with marked ranges.
- **Model No. AK10115**
- List Price £41.95

£29.95 Exc. VAT
£35.94 Inc. VAT

49pc 3/8" Sq Drive Master Extractor Set

3/8" Sq Drive

MM & IMP



- Left-handed HSS drill bits, used to drill pilot holes (reversible drill is required).
- Spiral flute extractors for use with bolts/fasteners.
- Multi-spline extractors when higher torque or restricted access is required.
- 3/8" Sq Drive reverse spiral bolt extractors designed for maximum grip of bolt and nuts.
- Contents: 5/64", 7/64", 1/8", 5/32", 3/16", 7/32", 1/4", 9/32", 19/64", 5/16", 11/32", 3/8", 13/32", 7/16", 15/32", 1/2", Spiral Flutes; #1, #2, #3, #4, #5, #6, Multi-Spline Extractors; 1/8", 5/32", 3/16", 7/32", 1/4", 9/32", 5/16", 11/32", 3/8", 13/32", 7/16", 15/32", 1/2", Reverse Spiral Bolt Extractors; 1/4", 5/16" (8mm), 3/8", (10mm), 7/16" (11mm), 12mm, 1/2", 13mm, 9/16" (14mm), 5/8" (16mm), 17mm, 11/16", 3/4" (19mm).
- **Model No. AK8149**
- List Price £164.95

£119.95 Exc. VAT
£143.94 Inc. VAT

Wire Brush with Steel Fill

LIFETIME GUARANTEE*



- Composite stocked brush with a contoured soft grip handle and hanging hole.
- Black high carbon steel filled head suitable for general-purpose applications.
- **Model No. WB102**
- List Price £5.45

£3.95 Exc. VAT
£4.74 Inc. VAT

3pc Miniature Wire Brush Set

LIFETIME GUARANTEE*



- Composite stocked brush set with contoured soft grip handles and hanging holes.
- Stainless steel, nylon and brass filled heads suitable for cleaning spark plugs and smaller engineering components.
- **Model No. WB100**
- List Price £6.25

£4.45 Exc. VAT
£5.34 Inc. VAT

3pc Auto Engineer's Wire Brush Set



- Composite handles with hanging holes.
- Small and medium (35 and 90mm headed) brass filled brushes, for components such as glow/spark plugs and contacts, and a large steel filled brush (90mm head) for removal of rust and welding slag.
- **Model No. AK9801**
- List Price £6.75

£4.95 Exc. VAT
£5.94 Inc. VAT

300mm Combination Square

LIFETIME GUARANTEE* **MM & IMP**

- Adjustable, machined stainless steel blade with zinc alloy head.
- Head fitted with scriber, level vial and brass locking screw.
- Permanently marked with Metric and Imperial graduations.
- Suitable for woodworking trades.
- **Model No. AK6095**
- List Price £15.45



£10.95 Exc. VAT
£13.14 Inc. VAT

200mm(8") Digital Angle Rule

MM & IMP

- An angle finder that doubles as a rule.
- Perfect for finding both internal and external angles.
- The digital display is clear with easy calibration.
- Measuring range from 0° to 360°.
- Metric/Imperial rule which can be locked in any position.
- Rule Length: 200mm(8").
- **Model No. AK7200**
- List Price £49.95



£29.95 Exc. VAT
£35.94 Inc. VAT

1000mm/40" Steel Rule

LIFETIME GUARANTEE* **MM & IMP**

- High quality steel rule permanently marked in Metric and Imperial graduations.
- Includes hanging hole.
- **Model No. AK9643**
- List Price £22.95

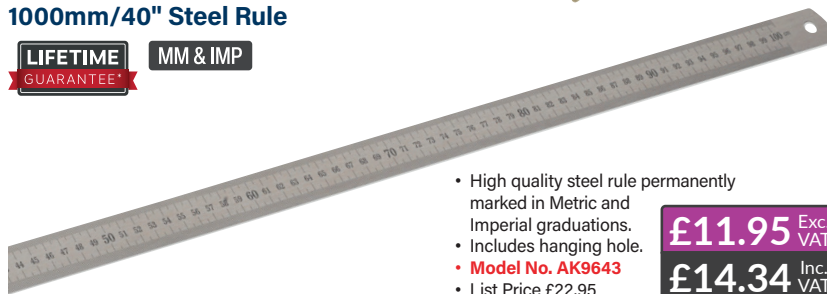

£11.95 Exc. VAT
£14.34 Inc. VAT

300mm Professional Hacksaws

Premier

LIFETIME GUARANTEE*



- Composite handles with comfortable rubberised grip.
- Lightweight metal frames with integral blade storage facility.
- Multi-angle adjustment for fast and accurate cutting.
- Supplied with high carbon steel blade suitable for cutting a variety of materials.

Model No.	Adjustable Blade	List Price	Exc. VAT	Inc. VAT
AK8684	✓	£30.95	£19.95	£23.94
AK8685	✗	£32.95	£21.95	£26.34

Magnetic Stand with Fine Adjustment without Indicator

LIFETIME GUARANTEE*

Magnetic



- Precision ground stand base with rotary controlled magnet.
- Fine arm adjustment allows close control.
- Suitable for use with scribers and dial gauges.
- **Model No. AK9581**
- List Price £49.95

£31.95 Exc. VAT
£38.34 Inc. VAT

Sheet Metal Disc Cutter



- Bench mounting, 8mm plate-steel disc cutter suitable for cutting up to 16 gauge steel sheet.
- Deep throat and small cutting disc allows tighter curves to be cut than traditional straight blade cutters. Ratchet action cutter blade.
- Suitable for car restoration work as well as general workshop use.
- **Model No. DC16**
- List Price £66.95

£54.95 Exc. VAT
£65.94 Inc. VAT

4" Mini Desk Fan



- Manufactured from durable composite material, ergonomically designed to pivot on a 180° axis, maximising the volume and direction of airflow.
- Single speed setting to keep a constant airflow around the room.
- Fitted with 3-pin plug.
- **Model No. SFF04**
- List Price £15.95



£12.95 Exc. VAT
£15.54 Inc. VAT

6" Oscillating USB Desk Fan



- Manufactured from composite materials with a steel fan guard.
- Oscillation control switch and pivot head allow the user to control how the airflow is distributed.
- Brushless motor keeps the fan quiet, making it ideal for office environments.
- 3-Speed settings.
- Supplied with a USB cable for powering by laptop or mobile power bank, alternatively can be powered by 3 x AA batteries (not included).
- **Model No. SFF6USB**
- List Price £24.95



£20.95 Exc. VAT
£25.14 Inc. VAT

8" Clip-On Fan



- Features tilt and swivel head for optimum air circulation.
- Switch control and fully guarded fan blades for extra safety.
- Smooth running motor powers fan blades.
- Maximum Airflow: 15m³/min.
- **Model No. SCF8W**
- List Price £22.95



£18.95 Exc. VAT
£22.74 Inc. VAT

Desk/Floor/Wall Fans

16"

Model No. SFF16



- Manufactured from durable composite material, ergonomically designed to pivot on a 180° axis, maximising the volume and direction of airflow.
- Can also be wall mounted.
- All three fans feature 3-speed settings.
- Fitted with 3-pin plug.

Model No.	Diameter	List Price	Exc. VAT	Inc. VAT
SFF08	Ø200mm(8")	£27.95	£23.95	£28.74
SFF12	Ø300mm(12")	£51.95	£41.95	£50.34
SFF16	Ø400mm(16")	£61.95	£44.95	£53.94



8"

Model No. SFF08



12"

Model No. SFF12



8" Portable Clip Fan with Worklight

8" 8W Magnetic

- Strong clip and magnet base, can position the fan in any place at any time.
- Four easy to use wind speed modes.
- 360° Rotation in all directions.
- Two light modes.
- Battery operated and is supplied with a 3.7V 4000mAh battery.
- Power Bank function with 5V=1A output.
- Run time: up to 10hrs on a full charge.
- Supplied with USB-A to USB-C port and cable; fully charged - 5hrs.
- Size (W x D x H): 216 x 95 x 251mm.
- **Model No. SCFBWL**
- List Price £35.95



NEW Product



£29.95 Exc. VAT
£35.94 Inc. VAT

Wall Fans with Remote Control



16" OR 18"

Available Early May

- Both fans feature tilt and oscillating head.
- Sleep mode for gradual reduction of fan speed.
- 3-Speed settings.
- Timer Function: 30mins-4hrs.
- Supplied with wall bracket.
- Supplied with electronic remote control.



Model No. SWF16WR

Model No.	Diameter	Max. Airflow	Power	List Price	Exc. VAT	Inc. VAT
SWF16WR	Ø400mm(16")	45m ³ /min	45W	£59.95	£44.95	£53.94
SWF18WR	Ø450mm(18")	97m ³ /min	65W	£69.95	£49.95	£59.94



Model No. SWF18WR

12" Oscillating Desk Tower Fan

- 12"
- 2-Speed
- Oscillation Function

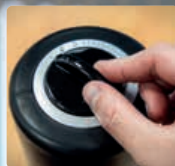

- Slimline fan design ideal for desktop use.
- Matte finish with 2-speed and oscillating functions.
- Smooth running highly durable copper motor powers fan blades and oscillating motor to aid powerful and even air distribution.
- Fitted with 3-pin plug.
- **Model No. STF12C**
- List Price £29.95

£19.95 Exc. VAT
£23.94 Inc. VAT

Oscillating Tower Fans



Model No. STF42
42" 3-Speed
Includes Remote

Model No. STF43Q
43" 5-Speed
QUIET RUNNING Includes Remote

Model No. STF30
30" 3-Speed



- Slimline fan design, suitable for floor or desktop.
- Smooth running motor powers fan blades and oscillating gearbox to aid powerful and even air distribution.
- Model No. STF30 has a built-in carry handle and up to 2hr auto-shut-off timer.
- Model No. STF42 has 3-speeds and an 8hr timer.
- Model No. STF43Q has five carefully programmed modes including - Sleep, Calm, Refresh, Cool, Power.
- Fitted with 3-pin plug.

Model No.	Size	Speeds	Remote	List Price	Exc. VAT	Inc. VAT
STF30	30"	3	✗	£51.95	£44.95	£53.94
STF42	42"	3	✓	£77.95	£67.95	£81.54
STF43Q	43"	5	✓	£114.95	£84.95	£101.94

Air Cooler/Heater/Air Purifier/Humidifier with Remote Control



- 4-in-1 Air cooler, heater, air purifier and humidifier.
- Remote control and panel control.
- Large 12L water tank supplied with ice pack.
- Generates negative ions to purify and sterilise output air.
- Hi-tech PTC heating element assures safer and rapid heating with two power options (1000/2000W).
- Adjustable airflow direction.
- Three selectable fan speeds.
- Fitted with castor wheels.
- Up to 12hr timer.
- **Model No. SAC41**
- List Price £199.95



£149.95 Exc. VAT
£179.94 Inc. VAT

Air Cooler/Purifier/Humidifier



- 3-in-1 Air cooler, air purifier and humidifier.
- Active carbon filter.
- 4L Water tank supplied with two ice packs.
- Adjustable airflow direction.
- Three selectable fan speeds.
- **Model No. SAC04**
- List Price £82.95



£54.95 Exc. VAT
£65.94 Inc. VAT

Air Cooler/Purifier/Humidifier with Remote Control



Includes Remote



- 3-in-1 Air cooler, air purifier and humidifier.
- Active carbon filter.
- Large 13L water tank supplied with two ice packs.
- Adjustable timer ranging from 30mins - 7.5hr.
- Adjustable airflow direction.
- Three selectable fan speeds.
- Supplied with electronic remote control.
- **Model No. SAC13**
- List Price £134.95



£94.95 Exc. VAT
£113.94 Inc. VAT

230V/20V SV20 Series 16" 2-in-1 Cordless/Corded High Velocity Drum Fan Kit



- Part of the SV20 Series designed for the professional, offering heavy-duty, high performance, durable tools with lightweight composite designs for superior control and comfort.
- Mains or cordless power means increased versatility in positioning cooling where it is most required.
- Handle and 360° tilting stand allowing control of airflow to exactly where it is needed.
- Carefully balanced and fully guarded aluminium blades provide quiet and safe operation.
- Running Time: 4Ah - 3.5hr, 6Ah - 5hr (On High Speed).
- To run cordless, body only requires compatible 20V battery and mains charger (sold separately). Kit is supplied with mains charger and 6Ah battery.

Model No.	Type	Batteries	List Price	Exc. VAT	Inc. VAT
HVD16CCOMBO	Kit	1 x 6Ah	£274.95	£139.95	£167.94
HVD16C	Body Only	-	£179.95	£89.95	£107.94

SEE PAGES 81-86 FOR MORE OF OUR 20V ONE-BATTERY-FITS-ALL RANGE.



Portable Air Conditioner/Dehumidifier/Air Coolers with Window Sealing Kit



- Thermostatically controlled with built-in 24hr timer and sleep mode.
- Self-evaporating system allows better efficiency, low maintenance and powerful cooling.
- Water-full indicator with auto-shut-off.
- Supplied with extendable exhaust ducting with window kit for ventilation and continuous drain hose.
- Air conditioning temperature range 16-32°C.
- Washable filter.
- Auto-defrost function at low ambient temperature.
- Mounted on castor wheels for manoeuvrability.



Model No. SAC7000

Model No.	Cooling Capacity	Maximum Water Extraction Rate	List Price	Exc. VAT	Inc. VAT
SAC7000	7,000Btu/hr	14.6L/day	£349.95	£274.95	£329.94
SAC9002	9,000Btu/hr	25L/day	£419.95	£329.95	£395.94

Window Sealing Kit for Air Conditioner Ducting



- Suitable for all types of hinged windows and skylights up to 300cm total perimeter.
- Easy to install using the supplied roll of self-adhesive hook-and-loop tape.
- Double zip makes positioning the ducting at any height easy.
- Saves energy by making the air conditioner or dryer more effective.
- **Model No. SACWK1**
- List Price £19.95

£14.95 Exc. VAT
£17.94 Inc. VAT

Portable Air Conditioner/Dehumidifier/Air Cooler/Heaters with Window Sealing Kit



- Thermostatically controlled with built-in 24hr timer and sleep mode.
- Soft-touch control panel with LED digital display and remote control.
- Self-evaporating system allows better efficiency, low maintenance and powerful cooling.
- Water-full indicator with auto-shut-off.
- Supplied with extendable exhaust ducting with window kits for extraction.
- Dehumidifying function including continuous drain hose.
- Eco-Friendly R290 refrigerant.
- Air conditioning temperature range 16-32°C.
- Washable filter.
- Auto-defrost function at low ambient temperature.
- Fitted with castor wheels. £649.95

Model No. SAC16000

NEW Product

3-Speed

Available Early May



Model No. SAC12000



Model No.	Speeds	Cooling Capacity	Maximum Water Extraction Rate	List Price	Exc. VAT	Inc. VAT
SAC12000	2	12,000Btu/hr	30.3L/day	£579.95	£439.95	£527.94
SAC16000 NEW Product	3	16,000Btu/hr	50.4L/day	£649.95	£499.95	£599.94

Portable Ventilators with 5m Ducting

Model No. VEN250



- Ideal for use where high-volume clean air delivery is required.
- Especially designed to easily ventilate hot or fume laden work areas, creating a cleaner and more pleasant working environment.
- Supplied with 5m ducting. Optional 10m ducting available, but not supplied (see right).
- Can be used across multiple industries including, but not exclusive to; marine, roof spaces and building sites, cable/pipe ducts and workshops.
- Lightweight in construction with large carry handles, making these units easily portable.
- Fitted with 2m cable and 3-pin plug.

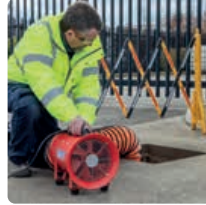

Model No.	Diameter	Motor	Static Pressure	Airflow	List Price	Exc. VAT	Inc. VAT
VEN200	Ø200mm	115W/230V	3.1mbar	20.55m ³ /min(725cfm)	£199.95	£109.95	£131.94
VEN250	Ø250mm	300W/230V	3.0mbar	45m ³ /min(1589cfm)	£219.95	£139.95	£167.94
VEN300	Ø300mm	500W/230V	3.9mbar	65m ³ /min(2295cfm)	£249.95	£169.95	£203.94

Flexible Ducting

Available Late April

(applies to VEN300AK1 only)

Ø200mm Ø250mm OR Ø300mm
5m OR 10m



Model No. VEN300AK1

Model No.	Application	Length	List Price	Exc. VAT	Inc. VAT
VEN200AK1	VEN200	5m	£64.95	£54.95	£65.94
VEN200AK2	VEN200	10m	£119.95	£99.95	£119.94
VEN250AK1	VEN250	5m	£74.95	£64.95	£77.94
VEN250AK2	VEN250	10m	£139.95	£124.95	£149.94
VEN300AK1	VEN300	5m	£84.95	£69.95	£83.94
VEN300AK2	VEN300	10m	£159.95	£124.95	£149.94

Portable Air Cooler



250W

NEW Product



Side View

- Water evaporation technology with air movement to provide more economical cooling without refrigerants.
- Maximum Airflow: 6000m³/hr.
- Three easy touch wind speeds.
- Two modes of swing and cooling function.
- 60L Water tank with inlet float valve and shortage alarm.
- Electronic ambient temperature display.
- Timing function from 1-12hr.
- Easy-clean with removable honeycomb cooling pads on all three sides.
- Manual or hose filling options
- Fitted with castor wheels.
- Supplied with remote control (batteries not included).
- **Model No. SAC100**
- List Price £599.95

£529.95 Exc. VAT
£635.94 Inc. VAT

Commercial Portable Air Cooler



- Portable, robust commercial air cooling unit.
- Useful for Indoor applications.
- Using water evaporation technology with air movement to provide more economical cooling without refrigerants.
- Three easy touch wind speeds.
- Features two modes, Swing and Cool, allowing you to oscillate the fan and initiate the evaporation technology.
- Maximum Airflow: 9000m³/hr.
- Large 125L water tank with inlet float valve.
- Water shortage alarm.
- Easy clean with removable high quality dust filters and honeycomb cooling pads.
- Castor wheels.
- **Model No. SAC125**
- List Price £799.95

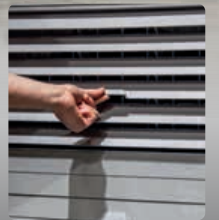

£679.95 Exc. VAT
£815.94 Inc. VAT

Desk & Pedestal Fans



Model No. SFF12DP
Desk Height

- Versatile fans manufactured from durable composite material with three height stages and 3-speeds.
- Adding or removing threaded extension sections converts the fan between a stand, low stand and desk fan with no need for tools.
- Fan head pivots vertically through 180° to control the direction of airflow.
- Fitted with 3-pin plug.



Model No. SFF12DP

Model No. SFF16DP

ADJUSTABLE HEIGHT

Model No.	Diameter	Speed Range	Adjustable Height	List Price	Exc. VAT	Inc. VAT
SFF12DP	Ø300mm(12")	1200-1350rpm	530/740/1000mm	£57.45	£43.95	£52.74
SFF16DP	Ø400mm(16")	1120-1300rpm	750/980/1275mm	£77.95	£59.95	£71.94

16" Quiet High Performance Oscillating Pedestal Fan

- 16" Oscillation Function
- Includes Remote



ADJUSTABLE HEIGHT

- High performance pedestal fan with advanced aerodynamic blades for maximum air movement.
- Quiet operation and high durability motor.
- Five carefully programmed modes include - Sleep, Calm, Refresh, Cool, Power.
- Offers quiet oscillation and adjustable fan head allowing great airflow in any room.
- Additional features include an 8hr timer, auto-dimming LED control panel and fully functional remote control and remote storage.
- Metal grill and height adjustment up to 1.4m(55").
- Ideal for home, bedroom and office environments.
- Weighted base for extra stability, tool-free and easy-to-assemble.
- Model No. SFF16Q
- List Price £89.95

£69.95 Exc. VAT
£83.94 Inc. VAT

18" Industrial High Velocity Floor Fan



- 3-Speed high output industrial fan at 1020, 1130 or 1300rpm.
- Balanced three blade propeller.
- Ideal for industrial, commercial, automotive and agricultural use.
- Maximum Airflow: 107m³/min(3760cfm).
- Fitted with 3-pin plug.
- Model No. HVF18
- List Price £99.95

£67.95 Exc. VAT
£81.54 Inc. VAT

20" Industrial High Velocity Floor Fan



- Maximum airflow up to 110m³/min.
- 3-Speed settings at 1100, 1225 or 1350rpm.
- Blade cradle tilts within frame.
- Fully guarded blades for safety.
- Mains cable storage.
- Suitable for industrial, commercial, agricultural, workshop and showroom applications.
- Model No. HVF20
- List Price £114.95

£84.95 Exc. VAT
£101.94 Inc. VAT

18" Industrial High Velocity Floor Fan with Internal Oscillation



- High velocity fan suitable for movement of huge volumes of air.
- Patented design with internally oscillating blades.
- Covers more than twice the area of a conventional non-oscillating fan.
- Provides constant airflow to complete area compared to standard oscillating fan which covers only 1/4 of the area at any one time.
- 3-Speed power selection with switchable oscillation control.
- Robust cradle stand enables secure positioning.
- Maximum Airflow: 55m³/min(1118cfm).
- Suitable for industrial, commercial, agricultural, automotive workshop and showroom applications.
- Model No. HVF18IS
- List Price £109.95

£74.95 Exc. VAT
£89.94 Inc. VAT

20" Industrial High Velocity Pedestal Fan

20"



- 3-Speed settings at 1100, 1250 or 1350rpm.
- Blade cradle tilts through 135° angle.
- Height-adjustable stand from 1300-1410mm.
- Large diameter base for added stability.
- Fully guarded blades for safety.
- Mains cable storage.
- Suitable for industrial, commercial, agricultural, workshop and showroom applications.
- Maximum airflow up to 138m³/min.
- **Model No. HVF20P**
- List Price £134.95



£99.95 Exc. VAT
£119.94 Inc. VAT

20" Industrial High Velocity Oscillating Pedestal Fan

20" Oscillation Function



- 3-Speed settings at 1050, 1150 or 1350rpm.
- Features tilting and oscillating head.
- Height-adjustable stand from 1080-1410mm.
- Fully guarded blades for safety.
- Suitable for industrial, commercial, agricultural, workshop and showroom applications.
- Maximum airflow up to 110m³/min.
- **Model No. HVF20PO**
- List Price £169.95



£119.95 Exc. VAT
£143.94 Inc. VAT

30" Industrial High Velocity Oscillating Pedestal Fan

30" Oscillation Function

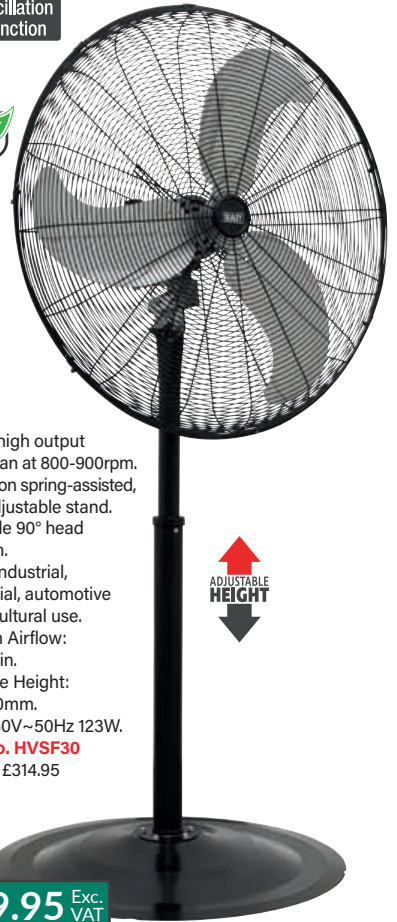

- 2-Speed high output pedestal fan at 800-900rpm.
- Mounted on spring-assisted, height-adjustable stand.
- Switchable 90° head oscillation.
- Ideal for industrial, commercial, automotive and agricultural use.
- Maximum Airflow: 288m³/min.
- Adjustable Height: 1610-2030mm.
- Motor: 230V~50Hz 123W.
- **Model No. HVSF30**
- List Price £314.95



£229.95 Exc. VAT
£275.94 Inc. VAT

Industrial High Velocity Drum Fans

Premier

3 YEAR GUARANTEE*



Model No. HVD24P 24"

Model No. HVD30P 30"

Model No. HVD36P 36"



- Robust units with heavy-duty gauge steel casing, guard and frame.
- Handle, wheels and tilt function cradle stand, allow the control of airflow where it is needed.
- Carefully balanced and fully guarded blades provide safe operation.
- Suitable for industrial, commercial, agricultural, automotive and showroom applications.
- Fitted with 3-pin plug.

IMPROVED EFFICIENCY

High efficiency industrial fans with improved motor and blade design, resulting in higher velocity with up to 30% more area coverage and reach.



Model No.	Diameter	Speeds	Max. Airflow	Power	List Price	Exc. VAT	Inc. VAT
HVD24P	Ø610mm(24")	2	266m ³ /min(9,420cfm)	330W	£329.95	£269.95	£323.94
HVD30P	Ø760mm(30")	2	288m ³ /min(10,175cfm)	315W	£459.95	£339.95	£407.94
HVD36P	Ø915mm(36")	2	363m ³ /min(12,855cfm)	410W	£559.95	£419.95	£503.94

Industrial High Velocity Drum Fans

A



16"
230V
3-SPEED

B



20"
230V
3-SPEED
360° Swivel Action

C



24"
230V
2-SPEED

D



24"
230V
2-SPEED
360° Swivel Action

E



30"
230V
2-SPEED
360° Swivel Action



Orbital Drums on HVF20S, HVF24S & HVF30S allow the fans to rotate through 360° for maximum versatility.

- High velocity industrial drum fans suitable for movement of huge volumes of air.
- Model No. HVD16 - lightweight, portable and robust unit fitted with rubber feet for stability.
- Robust units with heavy-duty gauge steel casing, guard and frame.
- Carefully balanced and fully guarded blades provide safe operation.
- Suitable for use in industrial, commercial, agricultural, automotive workshop and showroom applications.
- Fitted with 3-pin plug (Model No. HVD30110V fitted with 16A 110V plug).
- Featuring a 360° tilt function allowing for the direction of airflow to be positioned anywhere on a 360° axis.



30"
230V
2-SPEED



30"
110V
2-SPEED

Ref.	Model No.	Diameter	Speeds	Speed Range	Max. Airflow	Power	Voltage	360° Swivel	360° Tilt	List Price	Exc. VAT	Inc. VAT
A	HVD16	Ø400mm(16")	3	800-1225rpm	64.9m ³ /min(2292cfm)	124W	230V	✗	✓	£99.95	£51.95	£62.34
B	HVF20S	Ø550mm(20")	3	1150-1350rpm	123.5m ³ /min(4361cfm)	108.6W	230V	✓	✓	£169.95	£99.95	£119.94
C	HVD24	Ø610mm(24")	2	1350-1450rpm	155.3m ³ /min(5484cfm)	116.32W	230V	✗	✓	£239.95	£149.95	£179.94
D	HVF24S	Ø610mm(24")	2	1100-1350rpm	155.3m ³ /min(5484cfm)	116.32W	230V	✓	✓	£299.95	£199.95	£239.94
E	HVF30S	Ø760mm(30")	2	800-900rpm	283.4m ³ /min(10008cfm)	118.6W	230V	✓	✓	£439.95	£299.95	£359.94
F	HVD30	Ø760mm(30")	2	800-900rpm	283.4m ³ /min(10008cfm)	118.6W	230V	✗	✓	£319.95	£229.95	£275.94
G	HVD30110V	Ø760mm(30")	2	800-900rpm	284.8m ³ /min(10057cfm)	115.8W	110V	✗	✓	£359.95	£259.95	£311.94

Diamond Grip Extra-Thick Nitrile Powder-Free Gloves - Packs of 50



Model No. SSP56L



Model No. SSP57L

- Extra-thick 10mil nitrile for heavy-duty protection, ideal for automotive and industrial applications.
- Diamond Grip gloves for superior grip in wet and oily conditions.
- Chemical resistant.
- Powder-free for those with relevant dermatological conditions.
- Ambidextrous, conveniently fits either hand.

Model No.	Size	Colour	List Price	Exc. VAT	Inc. VAT
SSP56L	Large	Orange	£19.95	£9.95	£11.94
SSP56XL	X-Large	Orange	£19.95	£9.95	£11.94
SSP57L	Large	Black	£19.95	£9.95	£11.94
SSP57XL	X-Large	Black	£19.95	£9.95	£11.94

Anti-Cut PU Gloves (Cut Level C)



- Highest cut resistance - (Cut Level C) provides maximum protection against cuts and abrasions.
- Polyurethane-coated palm for improved grip.
- The whole liner is cut resistant, including the back of the glove.
- CE Marked and conforms to BS EN 388:2016 4-4-4-3-C.

Model No.	Size	List Price	Exc. VAT	Inc. VAT
9139L	Large	£5.25	£3.45	£4.14
9139XL	X-Large	£5.25	£3.45	£4.14

PVC Knit Wrist Gloves Pairs



- Knitted wrist waterproof gloves with PVC coating palm and back for excellent protection against abrasion.
- Wide-ranging applications, as waterproof coating repels oil, grease and non-corrosive liquids.
- CE Marked and conforms to BS EN 388:2016 3-1-2-1-X.

Model No.	Size	List Price	Exc. VAT	Inc. VAT
9106L	Large	£2.85	£1.95	£2.34
9106XL	X-Large	£2.85	£1.95	£2.34

Super Grip Knitted Gloves Latex Palm - Pairs



- Latex coating with poly cotton lining gives superior grip in wet and dry conditions.
- Breathable open back.
- Enhanced tear resistance.
- CE Marked and conforms to BS EN 388:2016 2-1-3-1-X.

Model No.	Size	List Price	Exc. VAT	Inc. VAT
9121L	Large	£1.85	£1.25	£1.50
9121XL	X-Large	£1.85	£1.25	£1.50

Super Cool Hide Gloves Pairs



- Full grain cowhide.
- Breathable back, with an elasticated wrist.
- Supple, hard-wearing premium glove.
- Conforms to BS EN ISO 21420:2020 and BS EN388:2016 - Levels 1143X.

Model No.	Size	List Price	Exc. VAT	Inc. VAT
9136L	Large	£9.95	£4.95	£5.94
9136XL	X-Large	£9.95	£4.95	£5.94

Brow Guard with Full Face Shield



- Ratchet adjustable headband with brushed nylon comfort band.
- Competitive quality for automotive, agricultural and industrial applications.
- Can be used with standard glasses.
- Conforms to BS EN 166, Optical Class 1, Impact Grade F.
- Model No. SSP10E
- List Price £18.95

£10.95 Exc. VAT
£13.14 Inc. VAT

Deluxe Brow Guard with Aspherical Polycarbonate Full Face Shield



- Ratchet adjustable headband with front and back padding for extra comfort.
- Polycarbonate visor for increased protection, stability and durability.
- Stepped angle adjustment on visor which simply flips up out of the way when not in use.
- Can be used with standard glasses.
- Premium quality for automotive, agricultural and industrial applications.
- Conforms to BS EN 166, Optical Class 1, Impact Grade F.
- Order Model No. SSP78.V2R for Replacement Visor.
- Model No. SSP78
- List Price £30.95

£17.95 Exc. VAT
£21.54 Inc. VAT

Reflective Rigger's Gloves - Pair



- Strong stitching, a generous fit and quality materials make this an ideal glove for heavy trade use.
- Bright dual coloured backing and reflective bands for increased visibility.
- Conforms to BS EN 21420:2020 and 388:2016 Level 2242X.
- Model No. SSP14HV
- List Price £4.75

£2.95 Exc. VAT
£3.54 Inc. VAT

Standard Goggles - Indirect Vent



- Clear polycarbonate safety lens with indirect ventilation in the frame.
- Conforms to BS EN 166, optical class 1, impact grade B.
- **Model No. 201**
- List Price £5.25

£3.25 Exc. VAT
£3.90 Inc. VAT



Hard Shell Gel Knee Pads - Pair



- Hard-wearing composite front cover for extended life with an anti-slip grip design.
- Adjustable wide straps.
- Anti-compression gel foam gives maximum cushioning for added comfort.
- **Model No. 9711**
- List Price £24.95

£14.95 Exc. VAT
£17.94 Inc. VAT



Corded Ear Plugs



Model No. 402/1 is supplied in plastic storage case.



- Triple flange design manufactured from a soft pliable material providing a comfortable fit.
- Corded for convenient carrying and helps prevent loss of plugs.
- Model No. 402/1 is supplied in plastic storage case.
- Model No. 402/50 are individually wrapped and supplied in bags of 50.
- SNR Rating: 32dB.
- Conforms to BS EN 352.

Model No.	Pack Qty	List Price	Exc. VAT	Inc. VAT
402/1	1	£1.45	£1.20	£1.44
402/50 NEW Product	50	£59.95	£39.95	£47.94

FFP1 Masks - Packs of 3



Model No. 9329/3

Model No. 9309/3

Model No. 9331/3

- Class FFP1 NR.
- Protects against non-toxic dusts and water-based aerosols.
- Fitted with adjustable band, nose liner and aluminium nose clip to fit all face contours.
- Filter Efficiency ≥ 80%
- Manufactured to BS EN 149:2001+A1:2009.

Model No.	Mask Type	Pack Qty	List Price	Exc. VAT	Inc. VAT
9329/3	Fold Flat	3	£3.45	£1.85	£2.22
9309/3	Cup	3	£3.55	£2.55	£3.06
9331/3	Cup Valved	3	£4.85	£3.25	£3.90

FFP2 Masks - Packs of 3



Model No. 9304/3

Model No. 9305/3

Model No. 9332/3

- Class FFP2 NR.
- Protects against slightly toxic or irritant aerosols and/or liquids.
- Fitted with adjustable band, nose liner and aluminium nose clip to fit all face contours.
- Filter Efficiency ≥ 94%.
- Manufactured to BS EN 149:2001 + A1:2009.

Model No.	Mask Type	Pack Qty	List Price	Exc. VAT	Inc. VAT
9304/3	Fold Flat	3	£4.15	£2.95	£3.54
9305/3	Fold Flat Valved	3	£4.85	£3.45	£4.14
9332/3	Cup Valved	3	£5.85	£3.95	£4.74

FFP3 Masks - Packs of 3



Model No. 9333/3

Model No. 9334/3

- Class FFP3 NR
- Protects against solid aerosols and/or liquids listed as toxic.
- Fitted with adjustable band, nose liner and aluminium nose clip to fit all face contours.
- Also fitted with breathing vent to provide more comfort and better communication as well as reducing heat build-up.
- Filter Efficiency ≥ 99%.
- Manufactured to BS EN 149:2001 + A1:2009.

Model No.	Type	Pack Qty	List Price	Exc. VAT	Inc. VAT
9333/3	Fold Flat Valved	3	£12.45	£8.95	£10.74
9334/3	Cup Valved	3	£15.45	£7.95	£9.54

Safety Helmets - Vented



- Ratchet suspension harness.
- Pop, twist and lock fitting system prevents unintentional loosening of headband.
- Material webbing cradle rather than rigid plastic means greater comfort when wearing all day.
- Conforms to BS EN397.
- Hearing and face shield accessories available.

Model No.	Colour	List Price	Exc. VAT	Inc. VAT
502B	Blue	£13.45	£8.95	£10.74
502BLK	Black	£13.45	£8.95	£10.74
502W	White	£13.45	£8.95	£10.74

General-Purpose Shovel with 900mm Metal Handle

HEAVY DUTY

- Heavy-duty spark-free shovel with forged metal shaft and YD handle.
- Large 365 x 470mm composite head ideal for use with snow, wood chips, compost, grain and debris.
- **Model No. SS01**
- List Price £47.95

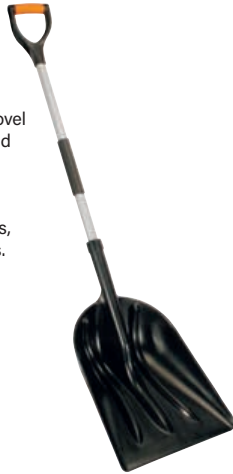

£34.95 Exc. VAT
£41.94 Inc. VAT

General-Purpose Shovel with 900mm Wooden Handle

HEAVY DUTY

- Heavy-duty spark-free shovel with hardwood shaft and YD handle.
- Large 365 x 470mm composite head ideal for use with snow, wood chips, compost, grain and debris.
- **Model No. SS02**
- List Price £51.95



£37.95 Exc. VAT
£45.54 Inc. VAT

26L Heavy-Duty Flexi Tub with Metal Handle - Black

26L



- Manufactured from heavy-duty polyethylene with a versatile, flexible construction.
- Ideal for a wide range of domestic and industrial applications.
- **Model No. SFT26H**
- List Price £8.45

£7.75 Exc. VAT
£9.30 Inc. VAT

Heavy-Duty Flexi Tubs

Model No. SFT30

30L



Model No. SFT40

40L



Model No. SFT65

65L



Model No. SFT40Y

40L



- Manufactured from heavy-duty polyethylene with a versatile, flexible construction.
- Ideal for a wide range of domestic and industrial applications.

Model No.	Capacity	Colour	List Price	Exc. VAT	Inc. VAT
SFT30	30L	Black	£7.75	£6.45	£7.74
SFT40	40L	Black	£9.45	£8.45	£10.14
SFT40Y	40L	Yellow	£12.45	£10.95	£13.14
SFT65	65L	Black	£15.45	£12.95	£15.54

Wheelbarrows

Model No. WB65

65L



Model No. WB85

85L

Model No. WBR01

100L

HEAVY DUTY



- Our wheelbarrows use air filled pneumatic tyres, perfect for absorbing impact and ideal for use on uneven surfaces and rough terrain.
- Constructed with strong tubular steel frame and rubber gripped handles.

Model No.	Capacity	Wheel Size	List Price	Exc. VAT	Inc. VAT
WB65	65L	Ø340mm	£79.95	£67.95	£81.54
WB85	85L	Ø405mm	£99.95	£79.95	£95.94
WBR01	100L	Ø390mm	£129.95	£109.95	£131.94

190mm Wire Rope/ Spring Cutter

Ø0-5mm

Premier

LIFETIME GUARANTEE



- High carbon steel blades, hardened, tempered and polished.
- Cuts up to Ø5mm wire rope and Ø1.5mm spring wire.
- Spring loaded handles with vinyl grip and safety lock.
- **Model No. AK503**
- List Price £25.95

£17.95 Exc. VAT
£21.54 Inc. VAT

260mm Fencing Pliers

Premier

LIFETIME GUARANTEE



- Manufactured from hardened and heat treated carbon steel.
- Finely ground heads with a fully polished finish.
- Head incorporates a striking face, pincer and clamp on top jaw.
- Vinyl dipped handles for comfort and control.
- **Model No. AK5450**
- List Price £19.95

£12.95 Exc. VAT
£15.54 Inc. VAT

1200mm Long Handled Fencing Spade



- Professional carbon steel fencing spade designed for digging post holes.
- Overall size of 1.5m helps to reduce back strain and offers long reach for added depth.
- Spade is very versatile and can break all ground types and chop through roots.
- Shovel Head Size: 300 x 170mm.
- **Model No. SFS01**
- List Price £39.95

£19.95 Exc. VAT
£23.94 Inc. VAT

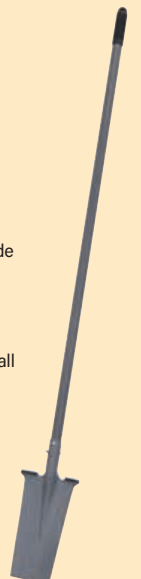

2-Stroke Petrol Earth Auger



- Drills holes up to 800mm deep and 200mm wide, ideal for seating trees, garden posts and fence supports into the ground.
- 52cc 2hp Petrol motor.
- Three different diameter bore sizes - Ø100, 150, 200mm.
- Twin ergonomic handles for comfort and ease of use (by one or two people).
- Auger brake automatically stops the bit from turning if hard underground impediment is hit.
- 1.2L Fuel tank capacity.
- **Model No. PHA100**
- List Price £249.95

£219.95 Exc. VAT
£263.94 Inc. VAT



250mm Earth Auger Drill

- Ideal for seating trees, garden posts and fence supports into the ground.
- Durable and strong for maximum digging performance.
- For use with Sealey Model No. PHA100.
- **Model No. HA250**
- List Price £62.95



NEW
Product

£49.95 Exc. VAT
£59.94 Inc. VAT

Ø100mm 2-Stroke Petrol Post Driver

Ø100mm



- Heavy-duty and easy-to-use post driver, designed to knock posts up to Ø100mm into the ground.
- Powered by a lightweight, compact and powerful 2-stroke 52cc air cooled single cylinder engine.
- Recoil start and a fuel capacity of 1.3L.
- Especially useful when installing large numbers of posts, or where accessibility is restricted for heavier machinery.
- Supplied with three sets of post rings: 20 x Ø49mm, 50 x Ø69mm, 70 x Ø100mm, allowing the machine to be used with a wide range of diameter posts.
- Supplied complete with storage case with integral wheels for ease of transport, as well as full tool kit and fuel mixing container.
- **Model No. PPD100**
- List Price £589.95

£459.95 Exc. VAT
£551.94 Inc. VAT



Pressure Washers with TSS & Rotablast® Nozzles

AUTOMATIC TOTAL STOP SYSTEM

ROTABLAST NOZZLE

Included with combos:
SCS090 - Whiteout
Detailing Snow Foam



- Quick release nozzle system allows for fast selection between fan and Rotablast® nozzle.
- Pressure gun includes lock to avoid accidental start.
- Automatic Total Stop System (TSS) which switches the motor on and off when the trigger is operated, prolonging motor life.
- Supplied with 5m pressurized hose for ease of use and 5m power cable for extended reach.

Model No.	Contents	List Price	Exc. VAT	Inc. VAT
PW1610	Pressure Washer Only	£99.95	£84.95	£101.94
PW1610COMBO	PW1610 - Pressure Washer 100bar 390L/hr with TSS & Rotablast® Nozzle, SCS090 - Whiteout Detailing Snow Foam	£119.95	£104.95	£125.94
PW1860	Pressure Washer Only	£129.95	£114.95	£137.94
PW1860COMBO	PW1860 - Pressure Washer 130bar 420L/hr with TSS & Rotablast® Nozzle, SCS090 - Whiteout Detailing Snow Foam	£149.95	£129.95	£155.94
PW2400	Pressure Washer Only	£319.95	£249.95	£299.94
PW2400COMBO	PW2400 - Pressure Washer 170bar 450L/hr Lance Controlled Pressure with TSS & Rotablast® Nozzle, SCS090 - Whiteout Detailing Snow Foam	£339.95	£269.95	£323.94

Premier Snow Foaming Pressure Sprayer Kit

- Ideal for creating a thick snow foam when cleaning vehicles.
- Premium quality pump made from highly resistant materials.
- Safety valve with depressurization option.
- Large 60mm opening for easy refilling and reduced spillage.
- Translucent tank with level indicators.
- Supplied with three mixers which vary the ratio of air to cleaning fluid in the foam generation.



0.75L Premier



Model No. SCSG08COMBO

Model No.	Contents	List Price	Exc. VAT	Inc. VAT
SCSG08	Pressure Sprayer Only	£44.95	£21.95	£26.34
SCSG08COMBO NEW Product	SCSG08 - Pressure Sprayer, SCS090 - 5L Whiteout Detailing Snow Foam	£69.95	£41.95	£50.34

140bar Pull-Along Pressure Washer with TSS

400L/hr

AUTOMATIC TOTAL STOP SYSTEM



- Lightweight and powerful unit, designed for domestic and light trade use.
- Ideal for a range of applications including cleaning vehicles, patios, decking, motorbikes and barbecues.
- Fitted with a powerful 1800W motor with 400L/hr water flow rate and a maximum pressure output of 140bar.
- Includes Total Stop System.
- Fitted with accessory storage to ensure unit stays clutter-free and mobile.
- Supplied with 5m hose, spray gun and lance.
- Sits on two castor wheels and two fixed wheels for easy manoeuvrability.
- Rotablast option available with purchase of PWA02 (Rotablast Lance) and PW2500.32 (Compatible Pressure Gun).
- **Model No. PW2000PA**
- List Price £182.95



£149.95 Exc. VAT
£179.94 Inc. VAT

Pressure Washers with TSS & Rotablast® Nozzle 230V

400L/hr OR 438L/hr

AUTOMATIC TOTAL STOP SYSTEM

ROTABLAST NOZZLE



Model No. PW2200

- Professional, heavy-duty unit designed for extensive domestic and light commercial use.
- Automatic Total Stop System (TSS) which switches the motor on and off when the lance trigger is operated using less water and electricity and therefore prolonging the motor life.
- Fitted with 5m hose reel, accessory storage on back of unit and side mounted gun and lance holder.
- Features high quality polished chrome and brass fittings.
- Supplied with 5m hose, variable nozzle and Rotablast® nozzle.
- Supply: 230V - 13A.
- Supplied with power cable fitted with 3-pin plug.

Model No.	Motor	Flow Rate	Max. Pressure	List Price	Exc. VAT	Inc. VAT
PW2200	1800W	400L/hr	140bar	£299.95	£219.95	£263.94
PW2500	2500W	438L/hr	170bar	£364.95	£269.95	£323.94

Accessories for PW2200 & PW2500



Model No.	Type	List Price	Exc. VAT	Inc. VAT
PWA01	Variable Lance	£24.95	£19.95	£23.94
PWA02	Rotablast® Lance	£13.45	£10.95	£13.14
PWA03	Fixed Brush	£8.25	£5.95	£7.14
PWA04	Rotary Brush	£18.95	£12.95	£15.54
PWA05	Floor Brush with Detergent Tank	£48.95	£37.95	£45.54

150bar Pressure Washer Twin Pump with TSS & Rotablast® Nozzle

- Features two pumps and twin nozzle for up to 70% faster cleaning.
- Eco Soft cleaning mode only activates one pump for light use.
- Fast cleaning mode activates both pumps together and, with the twin flow nozzle, gets rid of the toughest dirt and stains.
- Quick release nozzle system allows fast selection between single or twin nozzle.
- Fitted with two 1250W motors with total 810L/hr water flow rate and a maximum pressure output of 150bar.
- Features Automatic Total Stop System (TSS) which switches the motor on and off when the trigger is operated, prolonging motor life.
- Supplied with 8m high pressure hose and reel, detergent bottle, 5m power cable and heavy-duty wheels.
- **Model No. PWTF2200**
- List Price £384.95



810L/hr

ROTABLAST® NOZZLE

£289.95 Exc. VAT

£347.94 Inc. VAT

Pressure Washers

- Suitable for commercial and domestic applications with 5m pressure hose, gun, lance and adjustable nozzle.
- Low-pressure liquid detergent injection system.
- Safety latch on trigger.
- Unit stands on two sucker feet to prevent movement and two wheels for easier mobility with an integral handle.
- N.B. Engine oil not included.
- PWM2500SP is a Self Priming model.
- PWDM3600 is heavy. Extra assistance must be provided at the delivery point to help safe delivery.



Model No.	Output Pressure	Flow Rate	Fuel Type	List Price	Exc. VAT	Inc. VAT
PWM1300	110bar(1595psi)	360L/hr	Petrol	£479.95	£349.95	£419.94
PWM2500	175bar(2538psi)	540L/hr	Petrol	£729.95	£499.95	£599.94
PWM2500SP	175bar(2538psi)	540L/hr	Petrol	£999.95	£659.95	£791.94
PWDM3600	250bar(3625psi)	900L/hr	Diesel	£1,999.95	£1,599.95	£1,919.94

Professional Pressure Washers

- Ideal for a wide variety of applications including commercial and agricultural use.
- Features Automatic Total Stop System (TSS) technology which switches the motor on and off when the lance trigger is operated, prolonging motor life.
- Fitted with hose reel, built-in pressure gauge and adjustable pressure controls.
- Supplied with stainless steel lance with adjustable spray nozzle.
- Supply: 230V - 13A.
- Supplied with 5m power cable fitted with 3-pin plug.



Model No. PW3500

420L/hr

Model No. PW5000

510L/hr



Accessories for PW3500COMBO
 PWA06 - Rotary Brush
 PWA07 - Fixed Brush
 PWA10 - Water Suction Kit

Model No.	Motor	Flow Rate	Max. Pressure	Accessories	List Price	Exc. VAT	Inc. VAT
PW3500	2100W	420L/hr	140bar	✗	£549.95	£359.95	£431.94
PW3500COMBO	2100W	420L/hr	140bar	✓	£579.95	£369.95	£443.94
PW5000	2500W	500L/hr	150bar	✗	£1,219.95	£899.95	£1,079.94

Hot/Cold Water Pressure Washers

- Professional, heavy-duty hot/cold water pressure washers designed for extensive domestic and light/heavy commercial use.
- Ideal for a range of applications including cleaning vehicles, commercial equipment, motorbikes, patios and decking.
- Fitted with a heavy-duty, upgraded induction electric motor with a diesel water heater.
- Double motor (pump and burner) with three high durability steel pistons and aluminium axial pump.
- Automatic temperature regulation.
- Features an ergonomic handle with accessory holder, detergent tank is built-in for direct suction.
- Features an automatic Total Stop System (TSS) which switches the motor and heater on and off when the lance trigger is operated, prolonging the motor life.
- Fitted with 8m hose reel.
- Manufactured with heavy-duty plastic wheels for transportation over rough terrain.
- Supply: 230V
- PW2500HW is heavy. Extra assistance must be provided at the delivery point to help its safe delivery.



Model No. PW2000HW

2300W

420L/hr

Model No. PW2500HW

3000W

540L/hr

75+ KG
HEAVY ITEM

Model No.	Motor	Flow Rate	Max. Pressure	Tank Capacity	List Price	Exc. VAT	Inc. VAT
PW2000HW	2300W	420L/hr	135bar	4.9L	£1,249.95	£999.95	£1,199.94
PW2500HW	3000W	540L/hr	170bar	16L	£2,699.95	£2,199.95	£2,639.94

Water Spray Gun - 9-Pattern



- Soft rubber grip handle with locking trigger on/off switch.
- Rotating spray head gives nine different options including straight, jet, mist, shower, angle, flat horizontal, flat vertical, fan and tap.

- **Model No. CC79**
- List Price £9.45

£7.45 Exc. VAT
£8.94 Inc. VAT

Water Spray Gun



- Manufactured from lightweight plastic with soft rubber grip handle.
- Features two adjustable pressure settings and flow rate control nozzle.
- Fitted with male inlet coupling.

- **Model No. CC86**
- List Price £11.45

£6.45 Exc. VAT
£7.74 Inc. VAT

Water Dispensing Gun



**Available
End Of April**

- Connects to water hose for dispensing mains pressure water.

- **Model No. SA928**
- List Price £43.95

£29.95 Exc. VAT
£35.94 Inc. VAT

Garden Hose Trolley 60m Capacity

60m Capacity



- Lightweight tubular steel frame with tough plastic snap-together parts - no tools required.
- Fitted with two composite wheels for easy manoeuvrability and two angled 1/2" hose connectors.
- Reel holds up to 60m of Ø13mm hose.

- **Model No. GH60**
- List Price £43.95

£29.95 Exc. VAT
£35.94 Inc. VAT

Water Hoses with Fittings

- 15m
- 30m
- OR
- 80m



- Green PVC hoses with Ø12mm bore.
- Polyester fibre reinforced 3-ply construction for added strength.
- Includes spray/jet nozzle, female connector, waterstop connector and threaded tap connector.

Model No.	Hose Length	List Price	Exc. VAT	Inc. VAT
GH15R/12	15m	£24.95	£18.95	£22.74
GH30R	30m	£43.95	£34.95	£41.94
GH80R	80m	£103.95	£79.95	£95.94

Premium Ø17mm Expandable Garden Hoses

Ø17mm

- 15m
- OR
- 30m



- Latex material increases the strength and durability of the garden hose. Weave design prevents tears when under tension.
- Supplied with brass fittings that can stop the build-up of rust, and stop the hose from cracking, leaking or corroding.
- Spray nozzle features comfortable trigger and handle as well as 10 different settings to suit a variety of tasks.
- Suitable for watering, gardening, pool cleaning, vehicle cleaning and much more.

Model No.	Hose Length	List Price	Exc. VAT	Inc. VAT
GH15E	15m	£34.95	£29.95	£35.94
GH30E	30m	£49.95	£39.95	£47.94

Auto-Rewind Control Garden Hose Reels

- Controlled Rewind
- Auto Layering
- Length Control



- 20m
- OR
- 30m

- Controlled, slow rewind which, unlike traditional retractable reels, returns the water hose at a safe speed.
- Auto layering mechanism distributes water hose evenly back into reel housing preventing it from jamming.
- Hose can be extended and stopped at any length.
- Fitted with 20m Ø13mm PVC garden hose with spray/jet nozzle.
- Composite housing with heavy-duty wall mounting swivel bracket.
- Supplied with 2m leader hose with quick coupler and tap connector.

Model No.	Hose Length	List Price	Exc. VAT	Inc. VAT
RWH20	20m	£169.95	£139.95	£167.94
RWH30	30m	£199.95	£164.95	£197.94

15m Heavy-Duty Retractable Water Hose Reel Ø13mm ID Rubber Hose

- 15m
- HEAVY DUTY**
- Ø13mm ID
- Steel Case



- Heavy-duty durable steel case.
- Fitted with heavy-duty 15m Ø13mm ultra-light, super-strong rubber hose with 2m leader hose.
- Features metal spray gun with nine pattern spray/jet nozzle.
- Finger grip bend restrictors for ease of use.
- Handles hot water up to 90°C and remains flexible in cold temperature as low as -40°C.
- Heavy-duty ratchet mechanism enables safe storage and use.
- Swivel wall mounting bracket included.
- **Model No. WHR1512**
- List Price £259.95

£209.95 Exc. VAT
£251.94 Inc. VAT

2pc Hose Guide Set



- 2-Piece set of hose guides helps stop air hoses, water hoses and electric cables from catching on tyres.
- Can be mounted on a wall so hoses and cables can be stored.
- **Model No. SHG01**
- List Price £9.95

£4.95 Exc. VAT
£5.94 Inc. VAT

Heavy-Duty Hot & Cold Rubber Water Hose

- HEAVY DUTY**
- 5m 15m OR 30m



Ø19mm

- Lightweight hose constructed with high strength polyester braided reinforcement for extreme durability.
- Suitable for all agricultural and workshop applications.
- Designed to remain flexible in extreme conditions from -40°C to 90°C.
- High flow Ø19mm hose is ideal for livestock and farming applications.
- Fitted with 3/4" BSP brass fittings to fit conventional water outlets.
- Anti-kink octagonal shaped hose helps reduce kinking and increase abrasion resistance.
- High pressure rating of 500psi.

Model No.	Length	List Price	Exc. VAT	Inc. VAT
HWH5M	5m	£30.95	£10.95	£13.14
HWH15M	15m	£77.95	£23.95	£28.74
HWH30M	30m	£144.95	£39.95	£47.94

Heavy-Duty Hose Reel Cart

HEAVY DUTY

- Lightweight and durable tubular steel design.
- Perfect for keeping longer water hoses neat and tidy.
- Includes a 1.8m leader hose with 3/4" BSP brass fittings.
- Can hold up to 120m of Ø13mm standard water hose or 50m of Ø19mm H/D hose (hose not included).
- Features a non-slip handle and a storage basket for frequently used tools.
- Fitted with easy-rolling 10" puncture proof PU wheels and solid axle for rough terrain.
- **Model No. HRCHD**
- List Price £199.95



£149.95 Exc. VAT
£179.94 Inc. VAT

Heavy-Duty Hose Reel Carts with Heavy-Duty Ø19mm Hot & Cold Rubber Water Hoses



- HEAVY DUTY**
- 5m 15m OR 30m



Model No.	Kit Contents	List Price	Exc. VAT	Inc. VAT
HRKIT5	HRCHD - Heavy-Duty Hose Reel Cart, HWH5M - 5m Heavy-Duty Ø19mm Hot & Cold Rubber Water Hose	£219.95	£149.95	£179.94
HRKIT15	HRCHD - Heavy-Duty Hose Reel Cart, HWH15M - 15m Heavy-Duty Ø19mm Hot & Cold Rubber Water Hose	£264.95	£159.95	£191.94
HRKIT30	HRCHD - Heavy-Duty Hose Reel Cart, HWH30M - 30m Heavy-Duty Ø19mm Hot & Cold Rubber Water Hose	£327.95	£169.95	£203.94

Large Sponge



- General-purpose bone-shaped sponge.
- **Model No. CC64**
- List Price £2.85

£2.45 Exc. VAT
£2.94 Inc. VAT

Aqua Flexi-Blade



- Cuts drying time in half.
- Removes excess water prior to chamoising.
- Blade Length: 300mm.
- **Model No. CC65**
- List Price £10.45

£6.95 Exc. VAT
£8.34 Inc. VAT

Genuine Chamois



- Genuine chamois leathers are a superior professional product, cut, conditioned, sized and 100% cod oil tanned.
- Genuine chamois is soft, supple and will leave surfaces lint and scratch-free.

Model No.	Size	List Price	Exc. VAT	Inc. VAT
CC72	2.5ft ²	£18.95	£14.95	£17.94
CC73	3.5ft ²	£20.95	£16.95	£20.34

10L Plastic Watering Can

10L



- Strong and durable 10L plastic watering can with easy carry handle for greater flow control.
- Includes detachable rose.
- **Model No. WCP10**
- List Price £14.45

£9.95 Exc. VAT
£11.94 Inc. VAT

14L Composite Bucket



14L



- Manufactured from highly durable thick walled polypropylene.
- Features pouring spout making it easier to empty contents.
- Fitted with plastic comfort grip handle.
- **Model No. BM16**
- List Price £7.25

£5.95 Exc. VAT
£7.14 Inc. VAT

2.5ft² PVA Chamois



- Absorbs water to remove residue and streaks for a spotless finish.
- 100% machine washable to clean and reuse.
- After cleaning, put back in storage case to keep soft until next use.
- **Model No. CC92**
- List Price £7.95

£5.95 Exc. VAT
£7.14 Inc. VAT

Microfibre Clay Bar Cloth



- Clay backed microfibre cloth designed as an alternative to clay bar detailing.
- Perfect for removing surface contaminants such as tree sap, rain stains, light rust, pollen and bugs leaving a smooth finish to your paint.
- High quality material allows for extended use compared to using a regular clay bar.
- Designed for use with clay bar lubricants.
- **Model No. CBC01**
- List Price £12.45

£9.95 Exc. VAT
£11.94 Inc. VAT

Sheen Microfibre Cloth



- Sheen Microfibre cloth attracts, holds and lifts dust from any surface.
- Double-sided cloth, particularly suitable for car interiors.
- Size: 400 x 400mm.
- **Model No. CC71**
- List Price £3.05

£2.65 Exc. VAT
£3.18 Inc. VAT

Large Interior Brush



- Sturdy bristles scrub away stains from upholstery, floor mats and vinyl tops.
- Angled design to reach corners easily.
- Contoured rubber grip for added comfort and control.
- **Model No. CC61**
- List Price £5.75

£4.95 Exc. VAT
£5.94 Inc. VAT

Long Handle Dip & Wash Brush



- Fine, split-top bristles gently loosen and brush away dirt.
- Does not mark expensive clear coats or painted finishes.
- Long handle for access to hard-to-reach areas.
- **Model No. CC52**
- List Price £9.45

£7.95 Exc. VAT
£9.54 Inc. VAT

Forta Microfibre Cloth



- Developed by professional detailers for fast removal of dust and wax from the car surface.
- Ultra-fine fibres, attract, lift and hold dirt, dust and grease with just a little water.
- Size: 400 x 400mm.
- **Model No. CC68**
- List Price £3.05

£2.25 Exc. VAT
£2.70 Inc. VAT

2-in-1 Shaggy Microfibre Mitt



- Double-sided mitt with shaggy microfibre strands on one side, superb for removing dirt or general cleaning.
- Non-abrasive mesh cloth on the other side, ideal for bugs and obstinate grime.
- **Model No. CC77**
- List Price £4.95

£3.95 Exc. VAT
£4.74 Inc. VAT

Flo-Thru Brushes

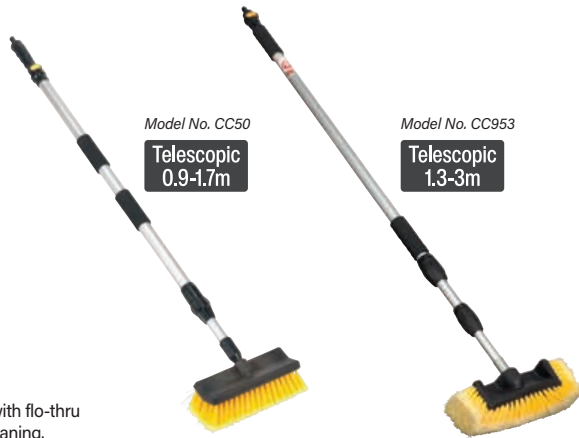

- Manufactured from tough, lightweight structural plastic that will not crack, bend or break.
- Super-soft synthetic bristles are safe to use on any surface.
- Leak resistant aluminium handle with flo-thru feature gives fast and thorough cleaning.

Model No.	Description	List Price	Exc. VAT	Inc. VAT
CC50	1.7m Large Angled Flo-Thru Brush with Telescopic Handle	£38.95	£29.95	£35.94
CC50BH	Flo-Thru Brush Head for CC50	£10.45	£8.45	£10.14
CC953	3m 5-Sided Flo-Thru Brush with Telescopic Handle	£48.95	£36.95	£44.34
CC953BH	Flo-Thru Brush Head for CC953	£17.95	£14.45	£17.34

10L Wet & Dry Vacuum Cleaner 1000W/230V

10L 1000W



- Powerful 1000W motor.
- 10L High-impact composite drum.
- Blower connection.
- Four castors to aid manoeuvrability.
- Tool and hose storage points on head.
- Ideal for vehicle cleaning, home cleaning and general workshop use.
- Supplied with crevice and floor tools, washable cloth filter, 3m cable and 3-pin plug.
- **Model No. PC102HV**
- List Price £82.95

£61.95 Exc. VAT
£74.34 Inc. VAT

10L Wet & Dry Vacuum Cleaner 1000W

10L 1000W



- Wet and dry operation.
- Powerful 1000W motor.
- 10L High-impact composite drum.
- Blower connection.
- Tool and hose storage points on head.
- Ideal for vehicle cleaning and general workshop use.
- Crevice and floor tools, cloth and foam filters, 2m cable and 3-pin plug.
- **Model No. PC100**
- List Price £76.95

£54.95 Exc. VAT
£65.94 Inc. VAT

Washable Cloth Filter for PC102HV

- **Model No. PC102CF**
- List Price £4.95

£3.95 Exc. VAT
£4.74 Inc. VAT



20L Wet & Dry Vacuum Cleaner 1200W Stainless Drum

20L

1200W

STAINLESS STEEL



- High powered, lightweight unit with blower facility.
- Constructed from stainless steel, the drum unit is mounted on four castor wheels.
- Tool storage points on head and base.
- Supplied with 4m cable, 3-pin plug and accessory tool kit, including three rigid extension tubes, wet-use foam filter and cloth filter.
- **Model No. PC195SD**
- List Price £99.95

£81.95 Exc. VAT
£98.34 Inc. VAT

Locking Cartridge Filter for PC195SD

- **Model No. PC195SDCFL**
- List Price £21.95

£13.95 Exc. VAT
£16.74 Inc. VAT



Foam Filter for PC195SD Pack of 10

- Pack of ten foam filters for Model No. PC195SD.
- **Model No. PC195SDF10**
- List Price £18.95

£11.95 Exc. VAT
£14.34 Inc. VAT



20L Wet & Dry Vacuum Cleaner 1250W

20L 1250W



- High powered, lightweight unit with blower facility.
- Powerful 1250W motor head gives incredible suction through Ø35mm hosing.
- Constructed from high-impact plastic, the drum unit is mounted on two castor and two fixed wheels.
- Tool storage points on head and base.
- Designed for use with cartridge filter or dust collection bag (optional) for fast and clean disposal of waste.
- Supplied with cartridge filter and wet-use foam filter.
- **Model No. PC200**
- List Price £124.95

£99.95 Exc. VAT
£119.94 Inc. VAT

30L Wet & Dry Vacuum Cleaner 1100W

30L 1100W



- High powered, lightweight unit with blower facility.
- Constructed from high-impact plastic, the drum unit is mounted on four castor wheels.
- Tool storage points on the base.
- Supplied with 4m cable with 3-pin plug, tool kit, wet and dry cartridge filter.
- **Model No. PC300**
- List Price £144.95

£109.95 Exc. VAT
£131.94 Inc. VAT

Dust Collection Bag for PC200 Series - Pack of 5

- Pack of five dust collection bags for Model No's. PC200, PC200SD, PC200SDAUTO.
- **Model No. PC200PB5**
- List Price £22.95

£12.95 Exc. VAT
£15.54 Inc. VAT



Dust Bag for PC300.V2 - Pack of 3

- Dust bag for Model No. PC300.V2 Vacuum Cleaner.
- **Model No. PC300V2DB**
- List Price £22.95

£14.95 Exc. VAT
£17.94 Inc. VAT



Locking Cartridge Filter for PC200 Series

- Locking cartridge filter for later PC200 Series models.
- **Model No. PC200CFL**
- List Price £23.95

£14.95 Exc. VAT
£17.94 Inc. VAT



Plastic Filter Cartridge for PC300.V2

- Plastic filter cartridge for Model No. PC300.V2 Vacuum Cleaner.
- **Model No. PC300V2CF**
- List Price £32.95

£21.95 Exc. VAT
£26.34 Inc. VAT



2000W Steam Cleaner 1.8L Tank

2000W 1.8L Capacity

- Using only tap water, this unit produces pressurized steam up to a maximum of 160°C, which cleans, sanitizes and sterilizes.
- Standard Accessories: 2pc Extension Tube, Floor Scrub Brush, Floor Scrub Brush Cleaning Cloth, Floor Scrub Brush Adaptor, Small Tip Adaptor, Medium Brush, Small Brush, Small Power Jet Tip - Angled, Rotating Brush, Window Squeegee, Cloth for Window Squeegee, Wave Brush, Funnel and Measuring Jug.



STEAM LEAVES NO TOXIC RESIDUES.

IDEAL FOR SMALL BUT STUBBORN STAINS.

HEATS UP TO FULL TEMPERATURE IN ONLY 8 MINUTES.

PRODUCES PRESSURIZED STEAM UP TO A MAXIMUM OF 160°C.



- **Model No. VMSC01**
- List Price £207.95

£149.95 Exc. VAT
£179.94 Inc. VAT

20L 3-in-1 Ash Vacuum Cleaner 1200W/230V

20L

- Ideal for the collection of ash or fire debris from fireplaces, stoves, wood burners, BBQs, grills, brickwork, plasterboard, sawdust and fine dust.
- A powerful 1200W motor provides great suction performance whilst also acting as a blower.
- With a 20L capacity, the lightweight tank features quick release clips for ease of emptying.
- A 1.2m flexible metal lined suction hose allows the suction of ash up to a temperature of 40°C(100°F).
- Easily switch to blow function by using the outlet on the top of the vacuum.
- Fitted with unique, easy filter cleaning system; just place the hose end nozzle in the blower socket and press the black cleaning button at the same time.
- Includes a HEPA filter with metal cover preventing the leaking of ash and dust and round aluminium nozzle.
- Cable length 2.5m.
- **Model No. PC200A**
- List Price £84.95



£64.95 Exc. VAT
£77.94 Inc. VAT

5m Vacuum Hose



- 5m Vacuum hose extension.
- Suitable for use with Model No's PC200, PC200SD, PC200SDAUTO, PC200SD110V, PC300SD, PC300SDAUTO.
- **Model No. VACHOSE5M**
- List Price £27.95

£17.95 Exc. VAT
£21.54 Inc. VAT

HEPA Cartridge Filter for PC200A



- HEPA cartridge filter for use with PC200A ash vacuum.
- **Model No. PC200ACF**
- List Price £13.95

£10.95 Exc. VAT
£13.14 Inc. VAT

Dust Collection Bag for PC300 Series Pack of 5

- Dust collection bags for Model No's. PC300SD, PC300SDAUTO.
- **Model No. PC300PB5**
- List Price £29.95



£14.95 Exc. VAT
£17.94 Inc. VAT

Foam Filter for PC200 & PC300 Series - Pack of 10

- Pack of ten foam filters for Model No's PC200, PC200SD and PC300SD.
- **Model No. PC200FF10**
- List Price £19.95

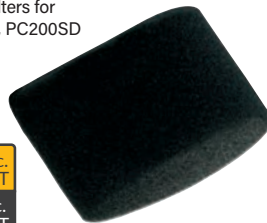

£13.95 Exc. VAT
£16.74 Inc. VAT

Fine Dust Cartridge Filter

- Cartridge filter for fine particles down to 1micron.
- Suitable for use with PC200 Series.
- **Model No. PC200CFF**
- List Price £30.95



£22.95 Exc. VAT
£27.54 Inc. VAT

Wet & Dry Industrial Vacuum Cleaners



STAINLESS STEEL

Model No. PC200SD
20L 1250W



Model No. PC300SD
30L 1400W



- Powerful motor head gives incredible suction through Ø35mm hosing.
- Blower facility.
- Tool storage points on head and base.
- Designed for use with cartridge filter or dust collection bag (optional) for fast and clean disposal of waste.
- Supplied with cartridge filter and wet-use foam filter.



Model No.	Motor Power	List Price	Exc. VAT	Inc. VAT
PC200SD	1250W	£144.95	£119.95	£143.94
PC300SD	1400W	£199.95	£159.95	£191.94

Wet & Dry Industrial Vacuum Cleaners 1400W with Stainless Drum & Auto Start



1400W

STAINLESS STEEL

Model No. PC200SDAUTO
20L

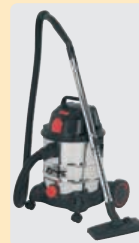

Model No. PC300SDAUTO
30L



- Powerful 1400W motor head gives incredible suction through Ø35mm hosing.
- Blower facility.
- Integral 3-pin socket provides power supply for dust-free tools up to 1400W.
- Auto-starts when dust-free tool is started and auto-stops 10 seconds after tool is switched off - to ensure tool and hose are left free of dust.
- Tool storage points on head and base.
- Supplied with cartridge filter and wet-use foam filter.

Model No.	Motor Power	List Price	Exc. VAT	Inc. VAT
PC200SDAUTO	1400W	£197.95	£139.95	£167.94
PC300SDAUTO	1400W	£259.95	£179.95	£215.94

30L Bagless Wet & Dry Industrial Vacuum Cleaner 1200W Stainless Steel Drum

30L 1200W STAINLESS STEEL

- Wet and dry vacuum cleaner powered by an efficient and powerful double stage 1200W motor.
 - Features multi-cyclonic technology which optimises airflow ensuring best suction at all times, producing outstanding cleaning results whilst using less energy than a standard cleaner.
 - 30L Stainless steel collection drum allows longer continuous cleaning before needing to be emptied.
 - Fitted with an integral 230V~50Hz (1800W) power outlet allowing the vacuum to be used in unison with a power tool.
 - Further features include on-board tool storage facilities, removable handle, large drain plug, quick release clasps and blower.
 - Supplied with a 4m cable and 3-pin plug, hose assembly, metal telescopic tube, wet and dry floor nozzle, crevice tool and multi-brush.
- **Model No. PC300BL**
• List Price £228.95

£199.95 Exc. VAT
£239.94 Inc. VAT



60L Wet & Dry Vacuum Cleaner 2400W Stainless Steel Drum

60L 2000W STAINLESS STEEL

- Industrial stainless steel drum with tough composite base and head.
 - Supplied with 1.5m EVA hose, wet floor nozzle, dry floor nozzle, crevice tool, stainless steel rigid tubes, cloth filter, cloth bag and vac brush.
 - Tank has easy empty cap with screw-on hose.
 - Fitted with two castor and two fixed wheels.
 - Cable storage hooks mounted on frame, accessories and extension tube holders on base.
- **Model No. PC460**
• List Price £434.95

£349.95 Exc. VAT
£419.94 Inc. VAT



Foam Filter for PC300BL Pack of 10

- **Model No. PC300BLFF10**
• List Price £18.95

£9.95 Exc. VAT
£11.94 Inc. VAT



Panel Filter for PC300BL

- **Model No. PC300BLPF**
• List Price £19.95

£10.95 Exc. VAT
£13.14 Inc. VAT



Foam Filter for PC460

- **Model No. PC460.ACC7**
• List Price £5.95

£4.95 Exc. VAT
£5.94 Inc. VAT



77L Wet & Dry Industrial Vacuum Cleaner 2400W Stainless Steel Drum with Swivel Emptying

77L 2400W STAINLESS STEEL



- Twin motors offer superior vacuuming power.
 - Suitable for industrial and commercial applications.
 - Stainless steel drum with dual filtration system for superior performance.
 - Features safety shut-off for wet operation.
 - Trolley with swivel drum and two rear locking wheels for easy emptying.
 - Front castors for added manoeuvrability.
 - Ø38mm Accessory kit, 5m cable with 3-pin plug, cloth and paper cartridge filters.
 - Optional front mounting squeegee with foot operated adjustment - Model No. PC477AK1.
- **Model No. PC477**
• List Price £769.95

£574.95 Exc. VAT
£689.94 Inc. VAT



Cloth Filter Assembly for PC477

- **Model No. PC477.CF**
• List Price £32.95

£24.95 Exc. VAT
£29.94 Inc. VAT



Reusable Cartridge Filter for PC477

- **Model No. PC477.PF**
• List Price £37.95

£29.95 Exc. VAT
£35.94 Inc. VAT



Front Mounting Squeegee for PC477



- Designed for improved floor cleaning results, particularly for liquids.
- **Model No. PC477AK1**
• List Price £174.95

£134.95 Exc. VAT
£161.94 Inc. VAT

30L Wet & Dry Valeting Machines

30L Remote Function 230V



- High powered units ideal for cleaning carpets, car interiors, fabrics and upholstery.
- Supplied with carpet lance, handheld lance, full wet and dry vacuum accessory kit including adjustable stainless steel rigid extension tube, cartridge filter and foam filter.
- Large capacity drum with external detergent tank for easy filling.
- Features remote operation controls on nozzle, enabling switching between vacuum and detergent modes uninterrupted.



Model No.	Drum Type	Motor Power	List Price	Exc. VAT	Inc. VAT
VMA914	Plastic	1300W	£384.95	£199.95	£239.94
VMA915	Stainless Steel	1500W	£489.95	£299.95	£359.94

M Class Cartridge Filter



- M Class cartridge filter suitable for Model No's PC380M and PC380M110V Industrial Vacuum Cleaners.
- **Model No. PC380MCF**
- List Price £46.95

£31.95 Exc. VAT
£38.34 Inc. VAT

Foam Filter Pack of 3



- Suitable for Model No's PC380M and PC380M110V Industrial Vacuum Cleaners.
- **Model No. PC380MFF**
- List Price £14.45

£9.95 Exc. VAT
£11.94 Inc. VAT

M Class Dust Bag Pack of 5



- Suitable for Model No's PC380M and PC380M110V Industrial Vacuum Cleaners.
- 38L Capacity.
- **Model No. PC380MDB**
- List Price £48.95

£34.95 Exc. VAT
£41.94 Inc. VAT

M Class Tank Liner Pack of 5

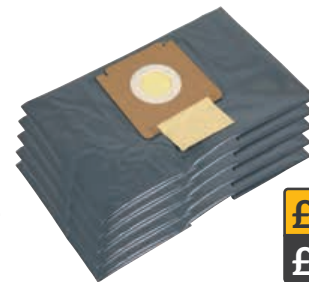

- Suitable for Model No's PC380M and PC380M110V Industrial Vacuum Cleaners.
- 38L Capacity.
- **Model No. PC380MTL**
- List Price £15.45

£10.95 Exc. VAT
£13.14 Inc. VAT

38L Dust-Free Wet & Dry Industrial Vacuum Cleaners

38L

STAINLESS STEEL



- Automatic electric power tool dust extractor/vacuum cleaners.
- M class filtration to 1 micron.
- Perfect for use as a regular industrial vacuum cleaner as well as for automatic use with electric sanders and all power tools with dust extraction outlets.
- Variable power tool adaptor to fit most power tools with inlet diameter of Ø27, 32 or 35mm included.
- Just insert power tool plug into socket on vac for automatic use.
- Removes 99.95% of hazardous dust with particles greater than 0.1mg/m³.
- Excellent for workshop or building site.
- Warning light shows when filter needs cleaning of hazardous dust.
- Filter self-cleaning system.
- Supplied with complete anti-static tool kit including round brush, multi-surface floor nozzle, power tool adaptor and 2.5m hose.
- Spare consumables: Dust Bags (x5), Tank Liners (x5), Foam Filter for wet use (x1) all included.

Model No.	Drum Type	Motor Power	List Price	Exc. VAT	Inc. VAT
PC380M	Stainless Steel	1500W	£364.95	£269.95	£323.94
PC380M110V	Stainless Steel	1100W	£364.95	£269.95	£323.94

Model No. PC380M
1500W
230V



Model No. PC380M110V
1100W
16A 110V



Aluminium Mop with Disposable Head

Disposable

- Allows for effortless cleaning when dealing with oil or other viscous substances.
- Mop head is completely removed and replaced by twisting the threaded mop handle.
- A replacement pack of five heads can be ordered, see Model No. DKM05.
- **Model No. BM14**
- List Price £13.45

£10.95 Exc. VAT
£13.14 Inc. VAT



350g Cotton Mop

- Lightweight highly absorbent cotton head, ideal for cleaning wooden, ceramic, stone and vinyl flooring.
- Features detachable mop head and 1330mm plastic handle.
- Replacement mop head available separately, order Model No. BM17R.
- **Model No. BM17**
- List Price £18.95

£14.95 Exc. VAT
£17.94 Inc. VAT



350g Mop Head



- Mop head for Model No. BM17.
- **Model No. BM17R**
- List Price £8.85

£6.95 Exc. VAT
£8.34 Inc. VAT

225g Pure Yarn Cotton Mop



- Highly absorbent, 100% pure yarn cotton head.
- Features straight-grained wooden handle with galvanized steel socket.
- Head Weight: 225g.
- **Model No. BM02**
- List Price £8.85

£5.95 Exc. VAT
£7.14 Inc. VAT



340g Pure Yarn Cotton Mop



- Highly absorbent, 100% pure yarn cotton head.
- Features straight-grained wooden handle with galvanized steel socket.
- Head Weight: 340g.
- **Model No. BM05**
- List Price £11.45

£8.95 Exc. VAT
£10.74 Inc. VAT

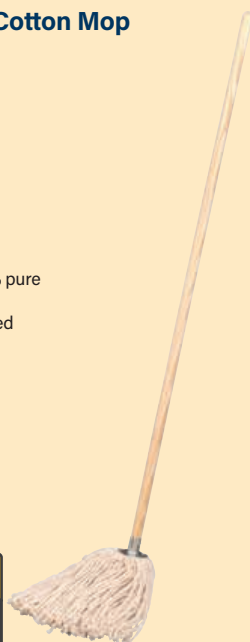

12L Stainless Steel Mop Bucket

12L

STAINLESS STEEL



- Manufactured from heavy-duty stainless steel grade 202.
- Perfect for domestic and industrial applications.
- 12L capacity.
- **Model No. BM8L**
- List Price £19.95

£15.95 Exc. VAT
£19.14 Inc. VAT

450g Kentucky Mop



- Extra thick, highly absorbent, 100% cotton head.
- Features straight-grained wooden handle with metal locking clip.
- Head Weight: 450g.
- **Model No. BM03**
- List Price £18.95

£14.95 Exc. VAT
£17.94 Inc. VAT

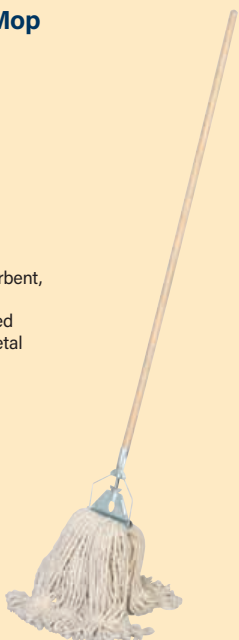

13L Galvanized Mop Bucket

13L



- Manufactured from heavy-duty galvanized steel with a 13L capacity.
- Fitted with mop head wringer and carry handle.
- Ideal for domestic and industrial applications.
- **Model No. BM08**
- List Price £39.95

£29.95 Exc. VAT
£35.94 Inc. VAT

20L Mop Bucket

20L



- Heavy-duty composite construction with detachable side press wringer and mop holder.
- Features Ø50mm non-marking castor wheels for added manoeuvrability.
- Fitted with carry handle.
- Maximum Capacity: 20L
- **Model No. BM09**
- List Price £82.95

£61.95 Exc. VAT
£74.34 Inc. VAT

15L Mop Bucket - 2-Compartment

15L



- Manufactured with two compartments featuring removable mop head wringer.
- Ideal for keeping clean water and dirty water separate while cleaning.
- Fitted with carry handles.
- Maximum Capacity: 15L.
- **Model No. BM07**
- List Price £30.95

£23.95 Exc. VAT
£28.74 Inc. VAT

Composite Dustpan & Brush Set



- Brush features long-life flexible bristles and locks onto pan for easy storage.
- Pan features rubber squeegee edge to ensure all dirt can be swept up with ease.
- **Model No. BM04**
- List Price £6.25

£4.95 Exc. VAT
£5.94 Inc. VAT

Metal Dustpan & Brushes



- Supplied with soft and hard bristle brushes.
- Heavy-duty, metal dustpan suitable for picking up dirt, dust and larger debris.
- **Model No. BM26**
- List Price £25.95

£19.95 Exc. VAT
£23.94 Inc. VAT

Floor Squeegees

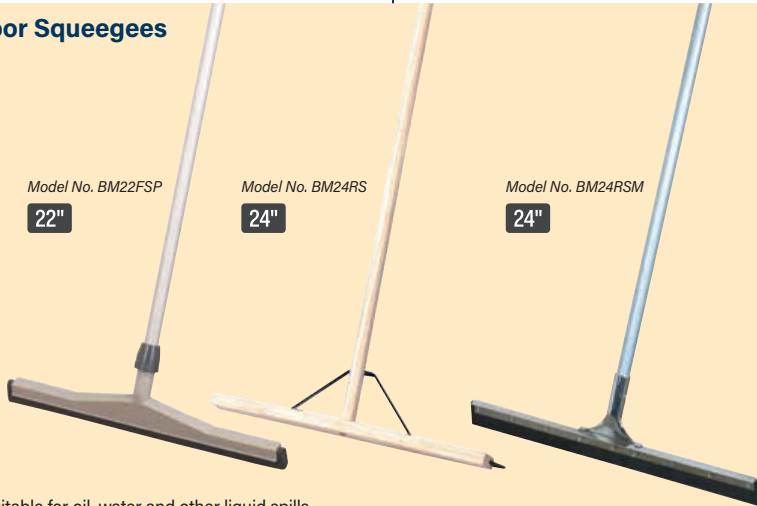

- Suitable for oil, water and other liquid spills.

Model No.	Type/Fill	Handle	Head Size	List Price	Exc. VAT	Inc. VAT
BM22FSP	Foam	Aluminium	22"(560mm)	£24.95	£19.95	£23.94
BM24RS	Rubber	Wood	24"(600mm)	£23.95	£18.95	£22.74
BM24RSM	Rubber	Aluminium	24"(600mm)	£30.95	£23.95	£28.74

Bulldozer Yard Dustpan & Brush Set



- Hard-wearing, dual purpose, split-tip polypropylene and PVC fibres ideal for indoor and outdoor surfaces.
- Large industrial pan with a rubber squeegee edge to ensure all media can be swept with ease.
- **Model No. BM04HX**
- List Price £20.95

£14.95 Exc. VAT
£17.94 Inc. VAT

Janitorial Trolley



- Robust unit fitted with two castors and two rubber wheels.
- Designed to accommodate mop buckets, brooms, brushes, cleaning agents and other necessary items.
- Fitted with hooks to hang refuse bags and lid to contain any odours.
- **Model No. BM30**
- List Price £139.95

£99.95 Exc. VAT
£119.94 Inc. VAT

300mm Workshop Floor Scraper

HEAVY DUTY

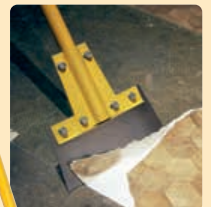

- Heavy-duty floor scraper suitable for use in both domestic and industrial environments.
- Carbon steel blade ideal for removing grease, dirt and other remains from tiled, concrete and laminate flooring.
- Strong, lightweight fibreglass handle with comfortable grip.
- Blade Size: 300mm.
- Length: 1500mm.
- **Model No. WFS02**
- List Price £32.95

£21.95 Exc. VAT
£26.34 Inc. VAT



Brooms

Model No. BM11S
11"



Model No. BM12H
12"



Model No. BM12S
12"



Model No.	Bristle	List Price	Exc. VAT	Inc. VAT
BM11S	Soft	£7.75	£4.95	£5.94
BM12H	Hard	£11.95	£8.95	£10.74
BM12S	Soft	£11.45	£8.45	£10.14

13"(325mm) Brooms Stiff/Hard Bristles

13"



Model No. BM13H



Model No. BM13HX



- Saddle back head.
- Ideal for indoor or outdoor use.
- Heavy-duty use in yards and gardens.

Model No.	Material	List Price	Exc. VAT	Inc. VAT
BM13H	PVC	£27.95	£21.95	£26.34
BM13HX	Cane	£21.95	£17.95	£21.54

24"(610mm) Brooms

24"



- Fitted with metal handle strengthening support.

Model No.	Bristle	List Price	Exc. VAT	Inc. VAT
BM16P	Hard-wearing PVC	£15.95	£12.95	£15.54
BM24H	Stiff/Hard	£26.95	£21.95	£26.34
BM24S	Soft	£25.95	£20.95	£25.14

36"(900mm) Brooms

36"



- Fitted with metal handle strengthening support.

Model No.	Bristle	List Price	Exc. VAT	Inc. VAT
BM36H	Hard	£33.95	£25.95	£31.14
BM36S	Soft	£30.95	£23.95	£28.74

24"(600mm) Bulldozer Yard Broom

24"

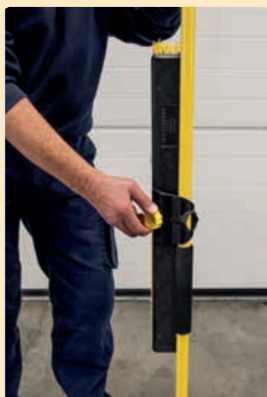

- Hard-wearing, dual purpose, split-tip polypropylene and PVC fibres ideal for indoor and outdoor surfaces.
- Stiff inner fibres sweep concrete, asphalt and other rough surfaces.
- Soft outer fibres are ideal for sweeping fine dirt and dust.
- Features high quality steel handle with grip bracket to secure and prevent damage to handle and resin block.
- Fitted with handle storage clips for easy storage.
- Model No. BM24HX
- List Price £34.95



£26.95 Exc. VAT
£32.34 Inc. VAT

16"(405mm) Heavy-Duty Stiff/Hard Bristle Broom with Scraper

16"



- Ideal for indoor or outdoor use, particularly for heavy-use in yards and gardens.
- Features scraper, ideal for ice and snow.
- Model No. BM16SC
- List Price £14.45



£11.95 Exc. VAT
£14.34 Inc. VAT

8"(200mm) Scrubbing Brush

8"



- Heavy-duty 8" scrubbing brush manufactured from hardwood.
- Contains stiff bassine fibres, great for rough surfaces.
- Suitable for indoor and outdoor use and ideal for use on patios, block paving, decking and laminate flooring.
- Model No. BM27
- List Price £3.95

£3.25 Exc. VAT
£3.90 Inc. VAT

11" Hand Brushes

11"



- Features ergonomic handle and hanging hole for easy storage.

Model No.	Bristle	List Price	Exc. VAT	Inc. VAT
BM25H	Hard	£4.25	£3.45	£4.14
BM25S	Soft	£4.25	£3.45	£4.14

Refuse/Storage Bins

50L 75L OR 95L



Model No. BM75G



Model No. BM95R



Model No. BM50



Model No. BM75G

Model No. BM50B

- Durable refuse/storage bins made from polypropylene.
- Fitted with lid latches to keep lid secure and carry handles.
- Suitable for outdoor use.

Model No.	Capacity	Colour	List Price	Exc. VAT	Inc. VAT
BM50	50L	Black	£25.95	£19.95	£23.94
BM50B	50L	Blue	£25.95	£19.95	£23.94
BM50G	50L	Green	£25.95	£19.95	£23.94
BM50R	50L	Red	£25.95	£19.95	£23.94
BM75	75L	Black	£35.95	£24.95	£29.94
BM75B	75L	Blue	£35.95	£24.95	£29.94
BM75G	75L	Green	£35.95	£24.95	£29.94
BM75R	75L	Red	£35.95	£24.95	£29.94
BM95	95L	Black	£44.95	£34.95	£41.94
BM95B	95L	Blue	£44.95	£34.95	£41.94
BM95G	95L	Green	£44.95	£34.95	£41.94
BM95R	95L	Red	£44.95	£34.95	£41.94

100L Refuse/Wheelie Bins



100L

- Durable refuse/wheelie bins made from polypropylene.
- Model No's BM100PR, BM100PG, BM100P, BM100PB feature a quick release foot pedal.
- Solid rear axle with two Ø200mm wheels and three robust handles allow the bins to be moved easily even when full.
- Dimensions (W x D x H): 595 x 570 x 765mm.

FOOT PEDAL

Ref.	Model No.	Colour	List Price	Exc. VAT	Inc. VAT
A	BM100PR	Red	£64.95	£53.95	£64.74
B	BM100PG	Green	£64.95	£53.95	£64.74
C	BM100P	Black	£64.95	£53.95	£64.74
D	BM100PB	Blue	£64.95	£53.95	£64.74

NO FOOT PEDAL

Ref.	Model No.	Colour	List Price	Exc. VAT	Inc. VAT
E	BM100R	Red	£59.95	£48.95	£58.74
F	BM100G	Green	£59.95	£48.95	£58.74
G	BM100	Black	£59.95	£48.95	£58.74
H	BM100B	Blue	£59.95	£48.95	£58.74

10m Layflat Water Hoses

10m



Model No. LFH1050

- High quality PVC hose reinforced with synthetic fibres.
- Suitable for water discharge only.

Model No.	Size	List Price	Exc. VAT	Inc. VAT
LFH1025	25mm x 10m	£19.95	£16.95	£20.34
LFH1032	32mm x 10m	£22.95	£18.95	£22.74
LFH1038	38mm x 10m	£26.95	£21.95	£26.34
LFH1050	50mm x 10m	£29.95	£24.95	£29.94

Submersible Water Pumps

Auto Cut-Out

- Manufactured from corrosion resistant materials with stainless steel motor case and Noryl® base cover.
- Designed for clean water, will accept small particles up to 5mm.
- Automatic low water cut-out.
- Suitable for the effective drainage of cellars, sinks, cisterns, baths and the general transfer of water.



Model No. WPC250A

Model No.	Max. Output	Max. Head	Min. Water Depth	List Price	Exc. VAT	Inc. VAT
WPC100A	100L(22gal)/min	6m	20mm	£64.95	£56.95	£68.34
WPC150A	167L(36gal)/min	8m	20mm	£74.95	£61.95	£74.34
WPC235A	208L(45gal)/min	8.5m	20mm	£84.95	£74.95	£89.94
WPC250A	250L(55gal)/min	9.5m	20mm	£94.95	£84.95	£101.94

100L/min Submersible Clean Water Pump

6000L/hr



- Max. Output: 100L/Min.
- Max. Pump Head: 6m.
- Minimum Water Depth: 5mm.
- Model No. WPC100
- List Price £59.95

£52.95 Exc. VAT
£63.54 Inc. VAT

225L/min Automatic Submersible Dirty Water Pump 230V

For Dirty Water

Auto Cut-Out

13500L/hr

- Manufactured from corrosion resistant materials with steel motor case and polypropylene base cover.
- Max. Output: 225L/Min.
- Max. Head: 8m.
- Min. Water Depth: 40mm.
- Automatic low water cut-out.
- Designed for operation in dense and dirty water.
- Suitable for the effective drainage of cellars, sinks, cisterns, baths and the general transfer of water and dense liquids.
- Model No. WPD235A
- List Price £89.95



£76.95 Exc. VAT
£92.34 Inc. VAT

Automatic Stainless Submersible Water Pumps

Auto Cut-Out

Model No. WPS225A

For Dirty Water

Model No. WPS250A

15000L/hr



- Min. Water Depth: 30mm.
- Automatic low water cut-out.



Model No.	Max. Output	Max. Head	List Price	Exc. VAT	Inc. VAT
WPS225A	225L/Min	7.5m	£124.95	£107.95	£129.54
WPS250A	250L/min.	8m	£134.95	£114.95	£137.94

92L/min 40m Head Automatic Submersible Stainless Water Pump

5520L/hr

Auto Cut-Out

40m Head

STAINLESS STEEL

- Manufactured from corrosion resistant materials with stainless steel body and motor case.
- Fitted with automatic low water cut-out.
- Designed for clean water although these pumps will accept small particles up to 0.5mm.
- Suitable for the effective drainage of cellars, sinks, cisterns, baths and the general transfer of water.
- Model No. WPS92A
- List Price £132.95



£109.95 Exc. VAT
£131.94 Inc. VAT

50L/min Submersible Water Butt Pump

3000L/hr

Auto Cut-Out

- Manufactured from corrosion resistant materials with a stainless steel motor case and Noryl® base cover.
- Supplied with a 2-piece aluminium swan neck extension pipe, adjustable flow control feature and snap on connector.
- Max. Output: 50L(13gal)/min.
- Max. Head: 10m.
- Model No. WPB50A
- List Price £74.95



£61.95 Exc. VAT
£74.34 Inc. VAT

117L/min Automatic Low Level 2mm Submersible Water Pump

7020L/hr

Auto Cut-Out

Low Level

- Manufactured from corrosion resistant materials with stainless steel motor case and Noryl® base cover.
- Max. Output: 117L(26gal)/min.
- Max. Head: 8m.
- Min. Water Depth: 2mm.
- Designed for clean water, will accept small particles up to 5mm.
- Automatic low water cut-out.
- Suitable for the effective drainage of cellars, sinks, cisterns, baths and the general transfer of water.
- Model No. WPL117A
- List Price £79.95



£67.95 Exc. VAT
£81.54 Inc. VAT

Surface Mounting Water Pumps

HEAVY DUTY

Model No. WPS060

3000L/hr



Model No. WPS062S

3300L/hr



- Suction pumps suitable for drawing brackish water.
- Suitable for lifting water up to 8m.

Model No.	Max. Output	Max. Head	Max. Particle Size	List Price	Exc. VAT	Inc. VAT
WPS060	50L(11gal)	35m	1mm	£129.95	£109.95	£131.94
WPS062S	55L(12gal)	38m	1mm	£139.95	£119.95	£143.94

Solid Wall Suction Hoses



Model No. WPS060HS



Model No. WPS060HL

- Solid wall hoses for use on suction side of water pumps.
- Suitable for use with Ø25mm inlets and outlets.

Model No.	Length	Size (ID/OD)	List Price	Exc. VAT	Inc. VAT
WPS060HS	4m	Ø25/30mm	£34.95	£27.95	£33.54
WPS060HL	7m	Ø25/30mm	£49.95	£41.95	£50.34

Surface Mounting Booster Pumps

Auto Cut-Out

- Ideal for boosting or maintaining water pressure within the home or garden water supplies.
- Fitted with automatic pressure cut-off valve.
- Suitable for lifting water up to 8m.



Model No. WPB050

3000L/hr



Model No. WPB062S

3300L/hr

STAINLESS STEEL

Model No.	Max. Output	Max. Head	Max. Particle Size	List Price	Exc. VAT	Inc. VAT
WPB050	50L(11gal)/min	35m	1mm	£229.95	£189.95	£227.94
WPB062S	55L(12gal)/min, 3300L(726gal)/hr	38m	1mm	£279.95	£224.95	£269.94

Inlet Filters for Surface Mounting Pumps

Model No. WPF2

2L



Model No. WPF1

1L



- High quality filters with a composite case. Includes a screw top lid to reveal the easy clean filter element. Ideal for fitting to Sealey and other brands of surface mounting pumps. Includes two female to male adaptors.

Model No.	Capacity	List Price	Exc. VAT	Inc. VAT
WPF1	1L	£23.95	£19.95	£23.94
WPF2	2L	£27.95	£22.95	£27.54

Ø50mm Water Pump 7hp Petrol

600L/min



Rear view.



- Economically designed petrol powered water pump with recoil starting.
- Suitable for on site applications where mains power supply is not available.
- Featuring 50mm inlet/outlet with 28m pumping head offering a high flow rate up to 600L/min of water.
- Protected by frame from accidental damage.
- **Model No. EWP050**
- List Price £349.95

£279.95 Exc. VAT
£335.94 Inc. VAT

Ø50mm x 5m Solid Wall Suction Hose for EWP050



- Solid wall hose for use on suction side of water pumps.
- Suitable for use with EWP050.
- Dimensions: Ø50mm ID x Ø60mm OD x 5m.
- **Model No. EWP050SW**
- List Price £77.95

£64.95 Exc. VAT
£77.94 Inc. VAT

36pc Screwdriver Set with Tool Tray



Siegen

LIFETIME GUARANTEE*



- Tray Size (W x D x H): 510 x 270 x 40mm.
- Model No. **S01128**
- List Price £79.95

£26.95 Exc. VAT
£32.34 Inc. VAT

15oz One-Piece Steel Claw Hammer

Premier

LIFETIME GUARANTEE*



- Model No. **CLHX15**
- List Price £36.95

£12.95 Exc. VAT
£15.54 Inc. VAT

16oz One-Piece Ball Pein Hammer

Premier

LIFETIME GUARANTEE*



- Model No. **BPHX16**
- List Price £34.95

£12.95 Exc. VAT
£15.54 Inc. VAT

9pc Anti-Slip Jumbo Spline Key Set

LIFETIME GUARANTEE*

M4 - M18 Jumbo Keys Magnetic



- Model No. **AK7189**
- List Price £109.95

£29.95 Exc. VAT
£35.94 Inc. VAT

1.5lb Hand Axe with Hickory Shaft

Premier

LIFETIME GUARANTEE*



- Model No. **AXH98**
- List Price £27.95

£9.95 Exc. VAT
£11.94 Inc. VAT

Small Motorcycle Cover 1830 x 890 x 1300mm

- Model No. **MCS**
- List Price £27.45

£7.45 Exc. VAT
£8.94 Inc. VAT



5m Electric Vehicle Portable Chargers & Cables

5m 10A **ev**

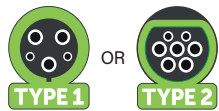

Model No.	Type	Current	Electrical Class	List Price	Exc. VAT	Inc. VAT
EVPC1	1	10A	1ph	£329.95	£129.95	£155.94
EVPC2	2	10A	1ph	£329.95	£179.95	£215.94

5m Type 1 to Type 2 EV Charger Cables

5m Model No. **EVCC1216** 16A



Model No. **EVCC1232** 32A

Model No.	Current	Electrical Class	List Price	Exc. VAT	Inc. VAT
EVCC1216	16A	1ph	£179.95	£74.95	£89.94
EVCC1232	32A	1ph	£204.95	£84.95	£101.94

Mechanic's Utility Seat & Toolbox

3 Drawer



- Model No. **SCR18Y**
- List Price £164.95

£89.95 Exc. VAT
£107.94 Inc. VAT



5m Type 2 to Type 2 EV Charging Cables

5m **ev** Model No. **EVCC2216** 16A



Model No. **EVCC22323** 32A



16A



Model No. **EVCC2232** 32A

Model No.	Current	Electrical Class	List Price	Exc. VAT	Inc. VAT
EVCC2216	16A	1ph	£179.95	£74.95	£89.94
EVCC22323	32A	3ph	£224.95	£114.95	£137.94
EVCC2232	32A	1ph	£204.95	£89.95	£107.94

12V Diagnostic Socket Memory Safe EOBD

12V



- Model No. VS2076
- List Price £99.95

£37.95 Exc. VAT
£45.54 Inc. VAT

Automotive Induction Probe



- Model No. VS5272
- List Price £25.95

£7.95 Exc. VAT
£9.54 Inc. VAT

Injector Removal Tool - Mercedes M271 Engine



- Model No. VS9033
- List Price £34.95

£2.95 Exc. VAT
£3.54 Inc. VAT

20pc Locking Wheel Nut Key Sets

Model No. SX214



Model No. SX216



• For distribution to bona fide vehicle dealers and repair centres only.

Model No.	Type	Contents	List Price	Exc. VAT	Inc. VAT
SX214	Vauxhall-A	Keys: Z16512 - 101, 102, 103, 104, 105, 106, 107, 108, 109, 110, 111, 112, 113, 114, 115, 116, 117, 118, 119, 120	£189.95	£39.95	£47.94
SX216	Vauxhall-C	Keys: Z16512 - 181, 182, 183, 184, 185, 186, 187, 188, 189, 190, 191, 192, 193, 194, 195, 196, 197, 198, 199, 200	£189.95	£39.95	£47.94

Diesel Injector Puller - Bosch



- Model No. VS7950
- List Price £12.95

£1.95 Exc. VAT
£2.34 Inc. VAT

12mm 3/8" Sq Drive Turbocharger Wrench - VAG

3/8" Sq Drive



- Model No. VS2033
- List Price £19.95

£2.95 Exc. VAT
£3.54 Inc. VAT

Workshop Series HVLP Suction Feed Spray Gun 1.7mm Set-Up

HVLP



- Model No. HVL740
- List Price £82.95

£27.95 Exc. VAT
£33.54 Inc. VAT

Workshop Series Gravity Feed Spray Gun - 2mm Set-Up



- Model No. SSG5
- List Price £61.95

£24.95 Exc. VAT
£29.94 Inc. VAT

140A MMA Inverter Welder

140A

MMA



- Model No. MW140I
- List Price £169.95

£99.95 Exc. VAT
£119.94 Inc. VAT

Premier

100A Gasless Inverter MIG Welder

100A

NON LIVE TORCH

MIG

Gasless



- Model No. MINIMIG100
- List Price £219.95

£124.95 Exc. VAT
£149.94 Inc. VAT

**400 x 400mm
Polypropylene
Floor Tiles
Packs of 9**

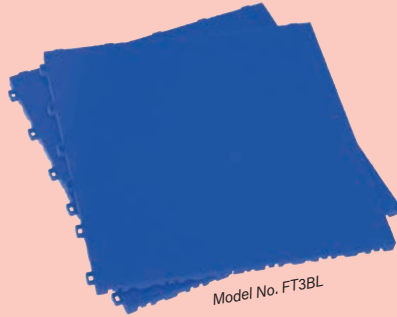

Model No. FT3BL

Model No.	Colour	List Price	Exc. VAT	Inc. VAT
FT3BL	Blue	£49.95	£15.95	£19.14
FT3W	White	£49.95	£15.95	£19.14
FT3GR	Green	£49.95	£15.95	£19.14

Fast-Fix Fillers & Adhesives



Model No. SCS910

Model No. SCS909

Model No. SCS906

Model No.	Filler Type	List Price	Exc. VAT	Inc. VAT
SCS910	White	£6.45	£2.95	£3.54
SCS909	Grey	£6.45	£2.95	£3.54
SCS906	Clear	£6.45	£2.95	£3.54

1W SMD LED Penlight 9-in-1 Multi-Tool

SMD LED Batteries Included



- Model No. LED091
- List Price £9.95

£4.75 Exc. VAT
£5.70 Inc. VAT

10W 10000mAh Portable Power Bank

10000mAh

10W



- Model No. SPB101
- List Price £21.95

£17.95 Exc. VAT
£21.54 Inc. VAT

RCD Safety Adaptor 230V



- Model No. RCD981
- List Price £19.95

£9.95 Exc. VAT
£11.94 Inc. VAT

Assortment Cases with Compartments



Model No. APAS16C



Model No. APAS24C

Model No.	Compartments	Size (W x D x H)	List Price	Exc. VAT	Inc. VAT
APAS16C	16	326 x 48 x 257mm	£9.95	£7.45	£8.94
APAS24C	24	510 x 71 x 347mm	£18.95	£12.95	£15.54

Parts Storage Case with Fixed & Removable Compartments



- Overall Size: 430 x 110 x 350mm.
- Model No. APAS10R
- List Price £34.95

£19.95 Exc. VAT
£23.94 Inc. VAT

Heavy-Duty HDPE Professional Tool Case

**HEAVY
DUTY**



- Size (W x D x H):
460 x 350 x 160mm.
- Model No. AP616
- List Price £103.95

£36.95 Exc. VAT
£44.34 Inc. VAT

840-1020mm Back Support Belt - Medium

WORKSAFE
SEALEY



- Model No. 9707M
- List Price £9.95

£1.95 Exc. VAT
£2.34 Inc. VAT

16" High Velocity Drum Fan

16"



ErP
compliant



- Model No. HVD16
- List Price £99.95

£51.95 Exc. VAT
£62.34 Inc. VAT

**Face Masks
Packs of 10**



Model No. 9304/10

Model No. 9305/10

Model No.	Mask Type	List Price	Exc. VAT	Inc. VAT
9304/10	FFP2 Fold Flat	£10.45	£4.15	£4.98
9305/10	FFP2 Valved Fold Flat	£11.95	£4.95	£5.94
9309/10	FFP1 Cup	£8.95	£3.85	£4.62
9329/10	FFP1 Fold Flat	£8.45	£3.85	£4.62
9331/10	FFP1 Valved Cup	£11.95	£4.15	£4.98
9333/10	FFP3 Valved Fold Flat	£30.95	£8.45	£10.14
9334/10	FFP3 Valved Cup	£37.95	£16.95	£20.34

**2 Tonne High Lift Low Profile
Trolley Jack**

2 Tonne
HIGH LIFT
LOW PROFILE
80mm



- Model No. 2200HL
- List Price £669.95

£369.95 Exc. VAT
£443.94 Inc. VAT

**25L 12V Pressure
Washer**

12V
36W
180L/hr



AUTOMATIC
TOTAL STOP
SYSTEM

- Model No. PW2512
- List Price £79.95

£32.95 Exc. VAT
£39.54 Inc. VAT

20m Water Hose Reel

20m
Auto Layering



- Model No. WR92
- List Price £119.95

£36.95 Exc. VAT
£44.34 Inc. VAT

**18m Retractable
Water Hose
Reel**

18m
HEAVY
DUTY



- Model No. RGH18
- List Price £289.95

£114.95 Exc. VAT
£137.94 Inc. VAT

**Automatic
Submersible
Clean
Water
Pumps**



Model No.
WPC150P

Auto Cut-Out
6000L/hr
11000L/hr
OR
13000L/hr
HEAVY
DUTY

Model No.	Max. Output	List Price	Exc. VAT	Inc. VAT
WPC100P	100L/min	£89.95	£41.95	£50.34
WPC150P	183L/min	£99.95	£44.95	£53.94
WPC235P	217L/min	£119.95	£64.95	£77.94

**Workshop
Bicycle
Stand**



HEAVY
DUTY

- Model No. BS103
- List Price £103.95

£44.95 Exc. VAT
£53.94 Inc. VAT

3.3 x 7.5 x 2.9m Instant Car Port Shelter

7.5m Length



- Model No. CPS02
- List Price £849.95



This item is heavy.
Extra assistance must be
provided at the delivery
point to help
safe delivery.

£439.95 Exc. VAT
£527.94 Inc. VAT

**300ml Fuel System
Cleaner - Petrol
Engines**



- Model No. FSCP300
- List Price £10.45

£2.95 Exc. VAT
£3.54 Inc. VAT



**300ml Oil System Cleaner
Petrol & Diesel Engines**



- Model No. OSCL300
- List Price £10.45

£2.95 Exc. VAT
£3.54 Inc. VAT



SEE INSIDE FOR GREAT DEALS...



Model No.
VS881

£19.95 Exc. VAT
£23.94 Inc. VAT

NEW Product SEE PAGE **39**

- OBDII/EOBD compliant vehicles Petrol 2001 and Diesel 2004 onwards.
- CAN enabled retrieves generic P0, P2, P3 and U10 codes and picks up manufacturer specific P1, P3 and U1 codes.
- This easy-to-use tool will then turn off the MIL light, clear codes and reset monitors.

EOBD Code Reader

SEE PAGE **123** **NEW Product**

Model No.
LED2500SB



2500 LUMENS

- Powerful 24W torch with 2500lm output.
- Four modes of light: low, medium, high and super beam mode.
- Convenient small pocket size for easy transportation.
- Intelligent LED charging indicator.
- Rechargeable battery with 2hr charge time.
- Includes strong magnet on the base to aid hands-free use.

24W SMD LED Super Beam Rechargeable Pocket Light

£22.95 Exc. VAT
£27.54 Inc. VAT



Model No.
S01266

NEW Product SEE PAGE **5**

- Comprehensive range of frequently used hand tools.
- 1/4" and 1/2" Sq drive reversible ratchet wrenches.
- Includes 1/4" and 1/2" Sq drive sockets, hex keys, combination spanners, screwdrivers, bit set, inspection mirror, magnetic pick up tool, ball-pein hammer, pliers and accessories.

3 Drawer Portable Tool Chest with 98pc Tool Kit

£259.95 Exc. VAT
£311.94 Inc. VAT

SEE PAGE **57** **NEW Product**



Model No.
RS2000

- Powered by lithium-ion technology and fully protected against short circuit, overload and reverse polarity.
- Fitted with a 20,000mAh lithium-ion battery and two USB Type-A outlets (5V/2A, 9V1.5A), Type-C input and output leads (5V/3A, 9V/3A, 12V/3A, 15V/3A, 20V/2.25A) and DC output 15V/10A.

2000A 12V RoadStart® Jump Starter Power Pack

£164.95 Exc. VAT
£197.94 Inc. VAT

SEE PAGE **27** **NEW Product**



Model No.
ES680D

- This engine stand accepts a wide variety of engines and transmissions.
- The geared handle drive allows for easy and accurate 360° rotation in order to access all parts of the engine.
- Mounting head has four fully adjustable arms with bolt holes to accommodate various load sizes.
- Fitted with screw lock to ensure load is secured.

680kg Folding 360° Rotating Engine Stand with Geared Handle Drive

£429.95 Exc. VAT
£515.94 Inc. VAT



Model No.
SAC100

NEW Product SEE PAGE **135**

- Portable air-cooling unit with a modern and robust design.
- Water evaporation technology with air movement to provide more economical cooling without refrigerants.
- Maximum Airflow: 6000m³/hr.
- Three easy touch wind speeds.
- Two modes of swing and cooling function.
- 60L Water tank with inlet float valve and shortage alarm.
- Electronic ambient temperature display.
- Timing function from 1-12hr.

Portable Air Cooler

£529.95 Exc. VAT
£635.94 Inc. VAT



Browse the Tool Promotion on our website.

YOUR LOCAL STOCKIST

Promotion valid:
1st April to 30th June 2024

Reference Code: TP2-2024

Call +44 (0)1284 757500
Email sales@sealey.co.uk
Web www.sealey.co.uk
Post SEALEY GROUP, Kempson Way, Suffolk Business Park, Bury St Edmunds, Suffolk. IP32 7AR



recycle

When you have finished with this publication please recycle it.

[f](#) [i](#) [o](#) [i](#) @sealeytools

Offers will be withdrawn when stock is sold. Prices exclude VAT unless otherwise stated. We reserve the right to withdraw offers, substitute products and change pricing at any time. Specifications and descriptions on this promotion are given in good faith but may change without notice and do not form any part of a sale contract, E & OE.

*Please refer to www.sealey.co.uk/guarantee for more information on guarantees. TRX-STAR, TRX-T5 and TRX-P tools are suitable for driving TORX® and TORX PLUS® fasteners respectively. TORX® and TORX PLUS® are registered trademarks of Acument Intellectual Properties, LLC.