



JOB DONE!

Workshop consumables and tools
to accelerate your productivity.

unitedindustrial.co.uk

2022/23 CATALOGUE



WE ARE United Industrial Supplies

Your one stop supplier for workshop consumables, tools, chemicals and janitorial products

With over 8,000 products, our catalogue is our biggest ever and offers a vast range of choice from a single source.

Who We Are

- Specialists in the automotive & industrial markets
- Established in 1976, acquired by Berner in 2012 and privately owned since April 2018
- Our Headquarters and Warehouse in Dunfermline, Scotland

Our Service

- Area Sales Managers for face to face contact and expert advice across the UK
- Online shop with over 10,000 products
- Source non-stocked items from current suppliers
- Bera Racking – the perfect workshop solution for storing parts
- ISO 9001: 2015 certified

Quality products
& competitive
pricing



Order Online

Unitedindustrial.co.uk

- View over 10,000 products
- Full product details
- View live stock availability
- 24/7 ordering

Order by Phone

01383 729814

- Monday – Thursday:.....8am to 5pm
- Friday:9am to 3pm

Contact us by Email

sales@unitedindustrial.co.uk

- Open a credit account online or call 01383 729814

FREE Delivery on orders over £75

Next Day to most of the UK

- Order by 3pm Monday – Thursday or 2pm on Friday for next business day delivery
- Restrictions apply for remote areas, Ireland and pallets

Our Brands

- We are the exclusive distributor of Berner product in the UK and stock a wide range of Berner tools, chemicals and consumables

- We also have various other brands of products available, including:



Abrasives	168-173
6 Hole Grip Discs	169
Abranet Grip Discs	169
Abranet Grip Triangles	168
Autonet Grip Discs	168
Backing Pads	169
Belts	170
Cutting Discs	170
Emery Rolls	173
Fibre Discs	169
Finishing Pads	172
Flap Discs	170
Flap Wheels	172
Fleece Grinders	172
Grinding Discs	170
Grinding Stones	172
Grinding Wheel Dresser	172
Production Paper	173
Roloc Discs	171
Rust Removal Discs	171
Sanding Discs	169
Steel Wool	172
Wet & Dry Paper	173
Wire Brushes	171

Access Equipment	212-217
Bridging Steps	215
Scaffold Towers	216
Step Ladders	212-214
Warehouse Steps	216-217
Work Platform	215

Airline Fittings	144-147
100 Series	145
60 Series	144
Airflow	144
Air Hoses	147
Double Union Nuts	146
InstantAir	145
Parallel Sockets	146
PF	145
Reducing Bushes	146
Reducing Unions	146
Safeflow	146
Standard Adaptors	147
Tail Adaptors	147
Vertex	144
Water Traps	147
Whip Hoses	147
XF	146

Air Brake Fittings	196-202
Blanking Plugs	196
Compact Coils	197
Elbow Connectors	197
Elbow Studs	197
Palm Couplings	197
Raufoss Fittings	198-202
Straight Connectors	197
Stud Connectors	197
Studs, Plugs & Couplings	196
Tube Supports	196

Air Hose Reels	148
Air Connectors	148
Air Tool Oil	148

Air Tools	149-151

Assortments	44-62

Batteries	18
Button	18
Lantern	18
Procell	18
Rechargeable	18

Bera Storage System	86-88
BERA CLIC+ Cases	88
Racking	86-87
Storage Bins	86

Body Repair	180-183
Fibre Matting	180
Fillers	181
Masking Paper	180
Masking Tape	180
Onion Board	180
Preparation & Finishing Materials	180
Resins	180
Rust Treatments	182
Stone Chip	182
Trim Clips	183
Trim Removal Tools	182
Underbody Coating Gun	182
Underbody Coatings	182

Brakes	204-205
Brake Cleaner	204
Brake Nuts	205
Brake Shoe Hold Down Pins	205
Brake Shoe Hold Down Washers	205
Brake Springs	204
Brake Tubing	205
Copper Tubing	205
DOT 4	204
Engine & Parts Cleaner	204
Wire Brush	204

Bulb Guide	265

Burrs	161

Bus, Truck & Trailer	190-193
Anti-slip Mat	192
Budget Lock	193
Budget Tee Key	193
Cones	192
Hub Puller	193
MOT Holder	192
Steering Wheel Covers	191
Wheel Chocks	193
Wheel Nut Indicators	190
Wheel Stud Service Kit	193

Cable & Accessories	28-29
110V	29
230V	28

Chargers & Boosters	256-257

Conversion Tables	262-264

Drills	154-160
Cobalt Drills	156
Drill Sets	160
Holes Saws	158
HSS - Bright Finish Silver Metric	156
HSS - Imperial	154
HSS - Metric	154
HSS - Tin Coated Imperial	155
HSS - Tin Coated Metric	155
HSS - TOPLine Silver Drills Metric	156
Long Series	159
Multifunction	157
Pop Rivet Double Ended Drills	159
Reduced Shank	156
Sluggers Bits	160
Step Drills	159

Electrical	6-17
Autocable - Multicore	14
Autocable - Single Core	14
Autocable - Thin Wall	14
Autocable - Thin Wall Twin	14
Autocable - Twin Core	14
Auto Circuit Breakers	6
Battery Terminal Covers	16
Battery Terminals	16
Cable	14
Cable Clips	13
Cable Lugs	16
Cable Ties	13
Cable Ties Accessories	13
Connector Strips	12
Convoluted Tubing	15
Crimping Tools	15
Crocodile Clips	12
DT Connectors	17
Electrical Sprays	13
Fuse Holders	7, 9
Fuse Pullers	7
Fuse Testers	7
Fuses	6
Fuses - Cartridge	8
Fuses - Continental	9
Fuses - Domestic	9
Fuses - Glass	9
Fuses - Maxi Blade	7
Fuses - Mega	8
Fuses - Micro Blade	7
Fuses - Micro2 Blade	6
Fuses - Midi	8
Fuses - Mini Blade	7
Fuses - PAL	8
Heatshrink	17
Spiral Binding	15
Starter Cable	14
Strip Fuses	9
Superseal Connectors	6
Switches	9
Terminals - Heatshrink	12
Terminals - Insulated	10-11
Terminals - Non Insulated	12

Fasteners	63-84
Acme Screws	80
Antiluce Fasteners	84
Ball Joint Sockets	83
Bolts	66-69
Chipboard Screws	84
Cladfast Screws	80
Cotter Pins	82
Linch Pins	81
Machine Screws	72-73
Number Plate Fixings	81
Nut Protectors	78
Nuts	73-74
Nuts - Flange	74
Nuts - Nyloc	74
Nutserts	83
O-Rings	77
Panel Screws	84
Parker Screws	80
R Clips	81
Rivets	82-83
Screwed Rod	73
Self Drilling Screws	80
Self Tappers	78-80
Serrated Flange Bolts	71-72
Set Screws	64-65,68
Socket Screws & Buttons	69-72
Speed Fasteners	81
Split Pins	81-82
Taptite Screws	80
Thru Locking Pins	84
Washers	75-77
Washers - Copper	76
Washers - Dowty	77
Washers - Fibre	77
Washers - Flat	75
Washers - Nord-Lock	77
Washers - Repair	75-76
Washers - Spring	76
Washer - Surface Screw Cup	78
Wire Rope Grips	84
Fire Safety	240
Fire Blankets	240
Fire Extinguishers	240
Safety Signs	240
First Aid Kits	241
Grease & Lubricants	30-35
Copper Grease	33
General Grease	33
Grease Guns & Components	34 - 35
Oils	33
Penetrating Fluids	30-32

Hand Care	243
Hand Tools	90-137
Bits	112-113
Blades	127
Bolt Cutters	128
Clamps	121
Crimping Tools	125
Extension Bars	100
Files	130
Hammers	117-119
Hex Keys	90-92
Knives	127-128
Locking Pliers	124
Loop Ratchet	99
Nut Drivers	110
Oil Filter Tools	109
Pick Up Tools	135
Pliers & Cutters	122-123
Punches	120
Ratchets	111
Rivet Nut Tool	134
Riveters	134
Saw & Saw Blades	129
Scrapers	126
Screwdriver Sets	116
Screwdrivers	114-116
Shears	128
Sockets	100-102
Socket Bits	98
Socket Sets	107-108
Sockets - Impact	103-106
Spanners	94-96
Spanners - Sets	97
Tape Measures	132
T-Handles	93
Thermometers	133
TX Keys	90-92
Universal Joints	100
VDE Tools	136-137
Vernier Gauges	132
Vices	121
Wire Brushes	131
Wire Strippers	125
Wrenches	110
Heaters	218-219
Hose Clips	210-211
Fuel Hose - Overbraided	211
Fuel Hose - Rubber	211
Hose Clips - Jubilee	210
Hose Clips - Stainless Steel	211
Hose Clips - Zinc	211
Mini Hose Clips	211
Rubber Lined P Clips	210

Janitorial	220-227
Air Fresheners	225
Bins	227
Bleach	223
Blue Industrial Roll	221
Brooms	227
Buckets	226
Centrefeed Rolls	221
Deb Hand Care	220
Glass & Mirror Cleaner	223
Graffiti Remover	225
Hand Wipes	225
Mops	226
Nail Brushes	226
Paper Hand Towels	222
Refuse Sacks	227
Scourers	224
Shovels	227
Surface Cleaner	223
Swarfega	220
Toilet Brushes	224
Toilet Cleaner	223
Toilet Rolls	222
Urinal Blocks	224
Washing Up Liquid	223
Window Cleaning Products	224
Karcher	232-233
Pressure Washers	232
Scrubber Dryers	233
Upholstery Cleaners	233
Vacuums & Dryers	233
Window Vacs	232
Lifting Slings & Belts	188
Lighting	19-27
Beacons	26
Bulbs 12V	20-23
Bulbs 24V	24-25
Dichroic Bulbs	27
Floodlights	27
Fluorescent Tubes	27
Fluorescent Tube Starters	27
Torches	19
Liquid Handling	234-235
Anti-freeze Recovery Unit	235
Barrel Pumps	235
Funnels	234
Oil Cans	234
Pump Sprayers	234
Waste Oil Collection Units	235
Watering Cans	234

Mains Electrical	27
Extension Lead	27
Extension Reel	27
Plugs	27
Maintenance & Repair	40-42
Additives	40
Cooling System & Metal Repair	41
Exhaust Clamps	42
Exhaust Repair	41-42
General Maintenance Sprays	40
Jointing Compounds & Instant Gasket	41
Paint	174-179
Acrylic Topcoats (RAL)	176-177
General Paints	174
Line Marking Paint	178
Mixing Cups	179
Paint Brushes	178
Paint Kettle	179
Paint Markers	178
Paint Rollers	179
Paint Trays	179
Thinners	178
VHT Topcoats	175
Pallet & Sack Trucks	187
Personal Protection (PPE)	244-253
Boilersuits	253
Coveralls	248
Ear Protection	249
Face Masks	247
Footwear	250
Gloves	244
Head Protection	249
Hi-Vis Clothing	251
Jackets	252
Knee Protection	248
Safety Spectacles	249
Sweatshirts/Hooded Sweatshirts	252
Thermal Clothing	253
Power Tools	152-153
Quick Connectors	143
Ratchet Straps	189
Safety Cabinets	85

Sanitisers	242
Alcohol Hand Gel	242
Anti-Bacterial Aerosols	242
De-misting Machine	242
Disinfectant Wipes	242
Sealants & Adhesives	36-39
Caulking Gun	38
Glue	36
Mastic Guns	38
Plastic Repair Adhesives	36
PU Sealants	37
RTV Sealants	37
Seam Sealers	37
Sika Products	39
Silicone Sealants	37
Thread Lockers	36
Windscreen Sealants	39
Slugger Bits	160
Soldering	142
Speedfit Couplings	195
Assorted Boxes	195
Nylon Elbows	195
Nylon Straights	195
Nylon T Pieces	195
Push-Fit Plugs	195
Push-Fit Reducers	195
Reducing Straight Connectors	195
Spill Control	236-239
Absorbent Pads & Rolls	236
Drain Covers	236
Drum Spill Pallets	237
Drum Top Mats	236
Spill Kit Packs	238-239
Spillpods & Refills	238
Storage & Security	89
Locks & Accessories	89
Storage Bins	89
Sump Plugs & Washers	43

Tapes	184-186
Amalgamating Tape	185
Anti-Slip Tape	185
Barrier Tape	186
Cable Fabric Tape	186
Conspicuity Tape	184
Curtain Repair Tape	184
Double Sided Tape	184
Expanding Foam Tape	184
Fine Line Tape	185
Gaffer Tape	185
Hazard Tape	186
Masking Tape	185
PVC Tape	186
Packing Tape	186
Single Sided Foam Tape	185
Thread Sealing Tape	186
Upholstery Tape	185
Taps & Dies	164-166
Thread Repair	162-163
Tubing	194
Nylon Tubing	194
Silicone Elbows	194
Silicone Hose	194
Valeting	228-231
Bumper & Wing Covers	231
Disposable Seat Covers	230-231
Floor Mats	231
Glass Cleaner	229
Microfibre Cloths	228
Rags	228
Rim Cleaner	229
Sponges	228
Steering Wheel Covers	231
Tyre Foam	229
Upholstery Cleaner	229
Vehicle Shampoo	229
Washing Brushes	228
Welding	138-141
Anti-Spatter Spray	140
Arrestors	141
Chalk	140
Contact Tips	141
Crack Detection Sprays	140
Cutting Torch	141
Hoses	141
Nozzles	140
PPE	138-139
Regulators	141
Rods	140
Welder	138

Wheel Nut Indicators	190
Wheels & Tyres	206-209
Axle Stands	209
Bottle Jacks	209
Buffing Stone	207
Plug Patches	207
Tyre Fitting Paste	207
Tyre Gauges	206
Tyre Inflators	206
Tyre Markers	208
Tyre Repair	207
Tyre Valve Extensions	207
Wheel Dolly	209
Wheel Removal Trolleys	208
Wheel Weights	207
Windscreen	259
Glass Sucker	259
Mirror Arm Puller	259
Windscreen Repair Kits	259
Winter Essentials	254-255
Antifreeze Tester	255
Coolant Tester	255
De-Icer	254
Fluid Testers	255
Ice Scraper	254
Multimeter	255
Refractometer	255
Screen Wash	254
Snow Shovels	254
Wiper Blades & Mirrors	258
Mirror Arms	258
Mirrors	258
Wiper Blades	258

Conversion Charts

SEE PAGES 262-264

- Conversion Factors
- Socket Set Conversions
- Metric Thread Pitch Sizes
- Hex Key/Socket Size Guide
- Tap Drills & Screw Thread Chart
- Screw Gauge Conversion
- Size Conversion

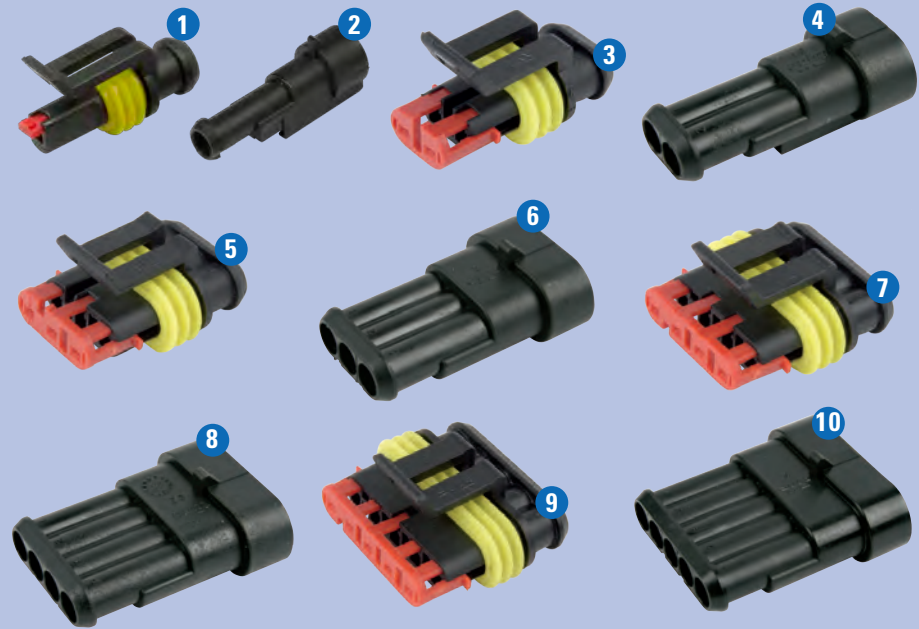

Part No.	Description	Qty	Price
1	B116666 1.5mm 1-way Female	1	£2.19
2	B116667 1.5mm 1-way Male	1	£2.19
3	B166676 1.5mm 2-way Female	1	£2.80
4	B166671 1.5mm 2-way Male	1	£2.83
5	B166677 1.5mm 3-way Female	1	£2.93
6	B166672 1.5mm 3-way Male	1	£3.30
7	B166678 1.5mm 4-way Female	1	£3.79
8	B166673 1.5mm 4-way Male	1	£4.13
9	B166679 1.5mm 5-way Female	1	£5.07
10	B166674 1.5mm 5-way Male	1	£4.60
11	B166680 1.5mm 6-way Female	1	£5.55
12	B166675 1.5mm 6-way Male	1	£5.07

20pc Pin and Socket Extraction Tool Kit



- For the dismantling of uninsulated cable clamps, (waterproof) connectors and plugs
- Applications: Audi, BMW, Ford, VVV, Vauxhall, Mercedes, Renault, Seat and Skoda
- Compact and ergonomic handles

£145.40

Part No. B335435

Ratchet Crimping Tool for Superseal Connectors



- For use with superseal connectors
- Soft grip handles
- H2 Die for 22-20 and 16 AWG (0.35 - 0.5mm² & 1.5mm²)
- H3 Die for 17 - 18 AWG (0.75mm² & 1mm²)

£95.40

Part No. BT007002

Auto Circuit Breakers



- Extends the benefits of a circuit breakers performance and convenience
- Materials: Tin plated zinc alloy
- Voltage rating: 32V DC max
- Operating temperature: -40 to + 85°C

Auto Reset

Part No.	Description	Qty	Price
517050	5A Light Brown	1	£5.69
517052	7.5A Brown	1	£5.69
517054	10A Red	1	£5.69
517056	15A Blue	1	£5.69
517058	20A Yellow	1	£5.69
517060	25A White	1	£5.69
517062	30A Green	1	£5.69

Manual Reset

Part No.	Description	Qty	Price
517064	5A Light Brown	1	£7.15
517066	7.5A Brown	1	£7.15
517068	10A Red	1	£7.15
517070	15A Blue	1	£7.15
517072	20A Yellow	1	£7.15
517074	25A White	1	£7.15
517076	30A Green	1	£7.15

Micro2 Blade Fuses

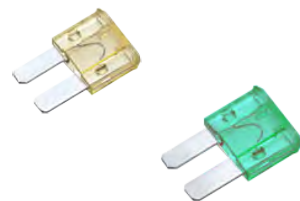

- Designed primarily for the latest vehicles to save space and weight
- Materials: Tin plated zinc alloy
- Voltage rating: 32V DC max
- Operating temperature: -40 to +105°C

Part No.	Description	Qty	Price
517020	5A Tan	50	£4.70
517022	7.5A Brown	50	£4.70
517024	10A Red	50	£4.70
517026	15A Blue	50	£4.70
517028	20A Yellow	50	£4.70
517030	25A White	50	£4.70
517032	30A Green	50	£4.70

Micro Blade Fuses



- Designed primarily for the latest vehicles to save space and weight
- Materials: Tin plated zinc alloy
- Voltage rating: 32V DC max
- Operating temperature: -40 to +105°C

Part No.	Description	Qty	Price
517000	2A Grey	100	£9.41
517002	3A Violet	100	£9.41
517004	4A Pink	100	£9.41
517006	5A Orange	100	£9.41
517008	7.5A Tan	100	£9.41
517010	10A Red	100	£9.41
517012	15A Blue	100	£9.41
517014	20A Yellow	100	£9.41
517016	25A Natural	100	£9.41
517018	30A Green	100	£9.41

Mini Blade Fuses

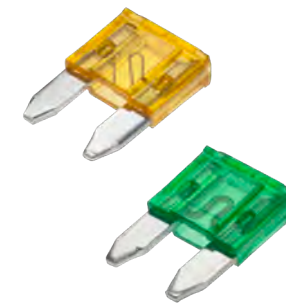

- Designed primarily for automobiles
- Materials: Tin plated zinc alloy
- Voltage rating: 32V DC max
- Operating temperature: -40 to +105°C

Part No.	Description	Qty	Price
B176830-100	1A Dark Green	100	£4.99
B176831-100	2A Grey	100	£4.99
B176832-100	3A Violet	100	£4.99
B930636-100	4A Pink	100	£4.99
B768430-100	5A Tan	100	£4.99
B768448-100	7.5A Brown	100	£4.99
B768456-100	10A Red	100	£4.99
B768464-100	15A Blue	100	£4.99
B768472-100	20A Yellow	100	£4.99
B768480-100	25A Natural	100	£4.99
B768499-100	30A Green	100	£4.99

Standard Blade Fuses



- Designed primarily for automobiles
- Materials: Tin plated zinc alloy
- Voltage rating: 32V DC max
- Operating temperature: -40 to +105°C

Part No.	Description	Qty	Price
B106129-100	1A Light Grey	100	£5.21
B543460-100	2A Grey	100	£5.21
B176893-100	3A Violet	100	£5.21
B176894-100	4A Pink	100	£5.21
B176895-100	5A Orange	100	£5.21
B176877-100	7.5A Brown	100	£5.21
B176869-100	10A Red	100	£5.21
B176850-100	15A Blue	100	£5.21
B176842-100	20A Yellow	100	£5.21
B176834-100	25A Natural	100	£5.21
B176826-100	30A Green	100	£5.21
B176829-100	40A Tan	100	£5.21

Maxi Blade Fuses



- Designed to protect high current circuits up to 100A
- Materials: Tin plated zinc alloy
- Voltage rating: 32V DC max
- Operating temperature: -40 to +105°C

Part No.	Description	Qty	Price
B781690-10	20A Yellow	10	£6.06
B781692-10	30A Green	10	£6.06
B781720-10	40A Saffron	10	£6.06
B781711-10	50A Red	10	£6.06
B781703-10	60A Blue	10	£6.06
B781704-10	70A Brown	10	£6.06
B836524-10	80A White	10	£6.06
B836525-10	100A Purple	10	£6.06

Standard Blade Fuse Holders

- Used for standard blade fuses
- Suitable for clipping together or fixing using a mounting plate
- Voltage rating: 32V

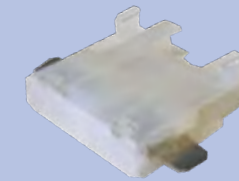

Part No.	Colour	Qty	Price
517436	White	10	£7.02
517438	Black	10	£7.02

Add A Circuit Fuse Holders



Part No.	Description	Qty	Price
516404	Standard	10	£28.19
516400	Micro	10	£28.19
516402	Mini	10	£28.19

Splash Proof Blade Fuse Holders

- Fitted with a lid to prevent ingress of water



Part No.	Description	Qty	Price
517450	20A Standard	10	£20.81
516304	30A Standard	10	£20.81
517452	30A Mini	10	£20.81
517454	80A Maxi	5	£17.64

Blade Fuse Pullers & Tester

- Suitable for standard blade fuses
- Material: PVC



Part No.	Description	Qty	Price
517460	Yellow	10	£8.60
517462	Red	10	£8.60
VANEFBK	Extractor/Tester	3	£24.42

PAL Fuses - Female



- Designed primarily for automobiles
- Material: Copper

Part No.	Description	Qty	Price
517100	20A White	10	£7.40
517102	30A Pink	10	£7.40
517104	40A Green	10	£7.40
517106	50A Red	10	£7.40
517108	60A Yellow	10	£7.40
517110	80A Black	10	£7.40
517112	100A Blue	10	£7.40

PAL Fuses - Male



- Designed primarily for automobiles
- Material: Copper

Part No.	Description	Qty	Price
517114	20A White	10	£7.40
517116	30A Pink	10	£7.40
517118	40A Green	10	£7.40
517120	50A Red	10	£7.40
517122	60A Yellow	10	£7.40
517124	80A Black	10	£7.40
517126	100A Blue	10	£7.40

PAL Fuses - Male Screw Fit

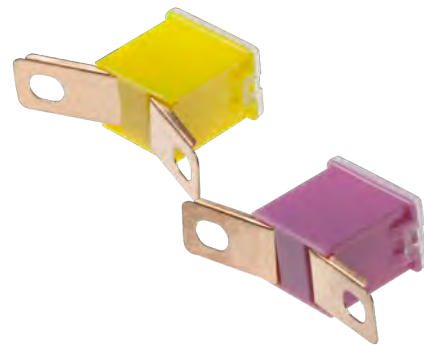

- Designed primarily for automobiles
- Material: Copper

Part No.	Description	Qty	Price
517128	20A White	10	£7.40
517130	30A Pink	10	£7.40
517132	40A Green	10	£7.40
517134	50A Red	10	£7.40
517136	60A Yellow	10	£7.40
517138	80A Black	10	£7.40
517140	100A Blue	10	£7.40

Standard & Low Profile Cartridge Fuses (JCASE Type)



- Designed primarily for automobiles
- Voltage rating: 32V DC max
- Provides increased time delay and low voltage drop to protect against excess current
- Operating temperature: -40 to +125°C
- Low profile: space and weight saving compared to standard size

Part No.	Description	Qty	Price
517412	20A Blue	10	£9.45
517414	25A White	10	£9.45
517416	30A Pink	10	£9.45
517418	40A Green	10	£9.45
517420	50A Red	10	£9.45
517422	60A Yellow	10	£9.45
517424	20A Blue Low Profile	10	£9.45
517426	25A White Low Profile	10	£9.45
517428	30A Pink Low Profile	10	£9.45
517430	40A Green Low Profile	10	£9.45
517432	50A Red Low Profile	10	£9.45
517434	60A Yellow Low Profile	10	£9.45

Mega Fuses



- Designed for high current circuit protection (up to 500A)
- Voltage rating: 32V

Part No.	Description	Qty	Price
517300	100A Yellow	10	£28.23
517302	125A Green	10	£28.23
517304	150A Orange	10	£28.23
517306	175A White	10	£28.23
517308	200A Blue	10	£28.23
517310	225A Light Brown	10	£28.23
517312	250A Pink	10	£28.23
517314	300A Grey	10	£28.23
517316	400A Black	10	£28.23
517318	500A Brown	10	£28.23

Midi Fuses



- Designed for high current circuit protection (up to 150A)
- Voltage rating: 32V

Part No.	Description	Qty	Price
517320	30A Orange	10	£9.54
517322	40A Green	10	£9.54
517324	50A Red	10	£9.54
517326	60A Yellow	10	£9.54
517328	70A Brown	10	£9.54
517330	80A White	10	£9.54
517332	100A Blue	10	£9.54
517334	125A Pink	10	£9.54
517336	150A Black	10	£9.54

Glass Fuses



- Suitable for automobile application
- Used for component surge protection
- Voltage rating: 250V
- Quick blow fuses
- Operating temperature: -55 to +125°C

Part No.	Description	Qty	Price
517200	2A Auto (30mm)	100	£6.30
517202	5A Auto (30mm)	100	£6.30
517204	10A Auto (30mm)	100	£6.30
517206	15A Auto (30mm)	100	£6.30
517208	20A Auto (30mm)	100	£6.30
517210	25A Auto (30mm)	100	£6.30
517212	35A Auto (30mm)	100	£6.30
517214	50A Auto (30mm)	100	£6.30
517216	1A Radio (20mm)	100	£5.94
517218	1.5A Radio (20mm)	100	£5.94
517220	2A Radio (20mm)	100	£5.94
517222	3A Radio (20mm)	100	£5.94
517224	5A Radio (20mm)	100	£5.94
517226	10A Radio (20mm)	100	£5.94

Auto Glass Fuse Holders

- Pack of 10
- Used for 30mm auto glass fuses
- Maximum current rating: 10A

£7.00

Part No. 517456

Fuse Holder for Mega Type Fuses

- For the MEGA range of fuses up to 500 amp rating, M8 studs

£11.85

Part No. 516306

Mains/Domestic Plug Fuses BS1362



- Domestic plug fuse
- Voltage rating: 240V

Part No.	Description	Qty	Price
517142	1A Red	50	£10.98
517144	2A Red	50	£10.98
517146	3A Red	50	£10.98
517148	5A Black	50	£10.98
517150	7A Black	50	£10.98
517152	10A Black	50	£10.98
517154	13A Brown	50	£10.98

Strip Fuses



- Used for diesel vehicles
- Suitable for protecting higher current circuits up to 100A
- Voltage rating: 32V

Part No.	Description	Qty	Price
517400	30A	50	£6.48
517402	40A	50	£6.48
517404	50A	50	£6.48
517406	60A	50	£6.48
517408	80A	50	£6.48
517410	100A	50	£6.48

Continental Fuses



- Used in the electrical systems of older cars
- Voltage rating: 32V

Part No.	Description	Qty	Price
516234	5A Yellow	100	£10.84
516238	8A White	100	£10.84
516242	16A Red	100	£10.84
516244	25A Blue	100	£10.84

Round Rocker Switch LED Red 12/24V

- Single pole switch
- 12/24 volt red LED indicator
- 4.8mm blade terminals
- Snap fits into 20mm diameter panel hole
- 10A at 12V DC rating



£4.29

Part No. 410260

On/Off Single Pole Rocker Switch 12/24V Amber LED Indicator

- Amber with work lamp symbol
- Snap fits into 20mm diameter panel hole
- 4.8mm blade terminals
- 10A at 12V DC rating



£9.02

Part No. 410266

On/Off Beacon Rocker Switch Round 12/24V Amber LED Indicator

- Amber with beacon symbol
- Snap fits into 20mm diameter panel hole
- 4.8mm blade terminals
- 10A at 12V DC rating



£9.65

Part No. 410265

Butt Connector

Part No.	Ø	Qty	Price
514266	4mm	100	£3.45

Female Push On (Spade)

Part No.	Ø	Qty	Price
514326	2.8mm	100	£5.54
514330	4.7mm	100	£5.07
514246	6.3mm	100	£4.43

Fully Insulated Female Push On (Spade)

Part No.	Ø	Qty	Price
514412	4.8mm	50	£6.16
514338	6.3mm	100	£5.18

Male Push On (Spade)

Part No.	Ø	Qty	Price
514392	6.3mm	100	£4.82

Female Bullet

Part No.	Ø	Qty	Price
514362	4mm	100	£5.65

Male Bullet

Part No.	Ø	Qty	Price
514358	4mm	100	£4.27

Rings

Part No.	Ø	Qty	Price
514230	3.5mm	100	£3.42
514400	4mm	100	£2.82
514236	5mm	100	£2.65
514420	6mm	100	£4.45

Fork

Part No.	Ø	Qty	Price
514286	3.5mm	100	£2.62

Butt Connector

Part No.	Ø	Qty	Price
514270	4.5mm	100	£3.90

Female Push On (Spade)

Part No.	Ø	Qty	Price
514250	6.3mm	100	£4.98

Fully Insulated Female Push On (Spade)

Part No.	Ø	Qty	Price
514318	6.3mm	100	£5.50

Male Push On (Spade)

Part No.	Ø	Qty	Price
514294	6.3mm	100	£4.56

Female Bullet

Part No.	Ø	Qty	Price
514306	5mm	100	£5.22

Male Bullet

Part No.	Ø	Qty	Price
514298	5mm	100	£4.97

Rings

Part No.	Ø	Qty	Price
514399	3.7mm	50	£1.52
514234	5mm	100	£3.56
514354	6mm	100	£4.88
514396	8mm	100	£4.85

Fork

Part No.	Ø	Qty	Price
514290	5mm	100	£3.26

Butt Connector

Part No.	Ø	Qty	Price
514274	6.8mm	100	£7.07

Female Push On (Spade)

Part No.	Ø	Qty	Price
514254	6.3mm	100	£8.85
514258	9.5mm	100	£7.19

Fully Insulated Female Push On (Spade)

Part No.	Ø	Qty	Price
514340	6.3mm	100	£8.69

Male Push On

Part No.	Ø	Qty	Price
514416	6.3mm	100	£7.85

Male Bullet

Part No.	Ø	Qty	Price
514610	5mm	100	£5.83
514615	5mm	100	£6.78

*514615: long internal copper sleeve

Rings

Part No.	Ø	Qty	Price
514310	5mm	100	£6.80
514238	6mm	100	£7.83
514242	8mm	100	£8.25
514322	10mm	100	£10.21
514366	12mm	100	£13.39

Piggyback Terminal Blue

Part No.	Ø	Qty	Price
514262	6.3mm	100	£6.26

12mm Connector Pin Blue

Part No.	Ø	Qty	Price
514282	12mm	100	£4.33

220mm Ratchet Crimping Tool (Insulated Terminals)

- Professional crimping tool for making good electrical connections
- Approved by SCM (Foundation for Certification of Vehicle Security)
- Suitable for insulated cable clamps from 0.5 - 6mm²

£28.37

Part No. B187739

220mm Ratchet Crimping Tool (Non-insulated Terminals)

- Professional crimping tool for making good electrical connections
- Approved by SCM (Foundation for Certification of Vehicle Security)

£34.64

Part No. B724351

860pc Electrical Terminals

£78.03

Part No. 168912

200pc Heat Shrink Terminals

£81.94

Part No. 168967

Butt Connectors



Part No.	Ø	Qty	Price
514406	0.5-1mm ²	25	£8.15
514403	0.5-1mm ²	100	£60.01
336815-100	0.5-1mm ²	100	£32.41

Ring Terminals



Part No.	Ø	Qty	Price
514536	4mm	25	£2.86
514233	5mm	25	£6.99
514540	6mm	25	£5.96

Butt Connectors



Part No.	Ø	Qty	Price
514402	1.5-2.5mm ²	25	£9.27
514404	1.5-2.5mm ²	100	£60.01
336823-100	1.5-2.5mm ²	100	£35.71

Ring Terminals



Part No.	Ø	Qty	Price
514348	5mm	25	£2.68
514508	6mm	25	£8.54

Butt Connectors



Part No.	Ø	Qty	Price
0-001-51	3-6mm ²	25	£18.51
514596	4-6mm ²	25	£10.16

Ring Terminals



Part No.	Ø	Qty	Price
514572	6mm	25	£12.27
514580	10mm	25	£12.27

Solder Butt Connectors



Part No.	For Cable	Qty	Price
514425	0.6-2mm	10	£11.63
514428	1.82-2.5mm	10	£11.63
514429	2.4-4.5mm	10	£11.63

Push On Connector Male



Part No.	Ø	Qty	Price
514560	6.3mm	25	£10.02

Push On Connector Female



Part No.	Ø	Qty	Price
514336	6.3mm	25	£7.56

Push On Connector Male



Part No.	Ø	Qty	Price
514528	6.3mm	25	£8.36

Push On Connector Female



Part No.	Ø	Qty	Price
514328	6.3mm	25	£9.26

Push On Terminal



Part No.	Ø	Qty	Price
514434	6.3mm	50	£6.71

Push On Terminal and Tag



Part No.	Ø	Qty	Price
514454	6.3mm	50	£7.19

Blade Terminal



Part No.	Ø	Qty	Price
514432	6.3mm	100	£12.45

Connector Strips

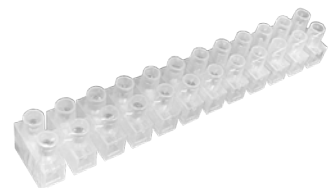

- 12 way terminal blocks
- Wire diameter: 6mm²

Part No.	Description	Qty	Price
514346	5A	10	£6.53
514350	15A	10	£10.67

Crocodile Clips



Part No.	Description	Qty	Price
512210	5A	25	£9.94
512218	50A	25	£13.51

Black Cable Ties



Part No.	Description	Qty	Price
574219	2.5 x 100mm	100	£0.92
808766	2.5 x 200mm	100	£1.20
574223	3.5 x 200mm	100	£2.52
574221	3.6 x 140mm	100	£1.43
0-002-55	3.6 x 295mm	100	£2.51
574233	4.8 x 120mm	100	£2.83
574235	4.8 x 160mm	100	£2.65
574243	4.8 x 200mm	100	£2.74
994300	4.8 x 295mm	100	£3.45
574240	4.8 x 295mm	200	£6.36

Natural Cable Ties

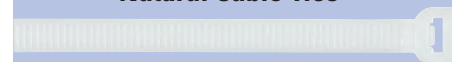

Part No.	Description	Qty	Price
574210	2.5 x 100mm	100	£1.16
574220	3.6 x 140mm	100	£1.72
574209	3.5 x 200mm	100	£3.08
574234	4.7 x 200mm	100	£1.30
574222	4.8 x 120mm	100	£2.65
574236	4.8 x 200mm	200	£4.16
574242	4.8 x 200mm	1000	£23.75

Coloured Cable Ties



Part No.	Description	Qty	Price	Part No.	Description	Qty	Price
574298	4.7 x 390mm	100	£10.63	574340	4.8 x 200mm	100	£3.02
574300	4.8 x 200mm	100	£3.02	574320	4.8 x 200mm	100	£3.02
9-104078	4.8 x 300mm	100	£6.65	575032	7.9 x 362mm Stainless Steel	100	£33.04
574360	4.8 x 200mm	100	£3.02				
9-104077	4.8 x 300mm	100	£6.65				

Sticky-Back Cable Tie Fixing Bases



Part No.	Description	Qty	Price
634320	3.5mm White	50	£5.12
634322	4.7mm White	50	£8.43
0-002-41	5mm Black	25	£8.98

Self-Adhesive Cable Clips



Part No.	Description	Qty	Price
634254	Small - 6mm	100	£10.27
634245	Medium - 11.5mm	50	£8.98

400ml Electronic Spray (Cleans)

- Cleans electrical components, circuit boards, connectors etc.
- Works quickly and effectively
- Removes resinous contact fats, oxide and sulphide
- Eliminates contact resistance
- Protects against oxidation
- Silicone and AOX free



£6.56

Part No. B409469

400ml Contact Spray (Protects)

- Eliminates and prevents contact resistance and faults with cable connections and plugs
- Strong, water-repellent effect
- Ensures good current flow
- Prevents oxidation and the formation of sulphide layers
- Prevents leaking current and loss of voltage
- Works on iron, metal, aluminium and plastics



£5.89

Part No. B408114

400ml Compressed Air Spray

- Removes dust, loose particles and fluff from electrical components, connectors, relays, switches, keyboards etc.
- Clean, dry and oil-free
- Residue free
- Will spray at 30° angle
- Silicone and AOX free



PACK OF 6

£22.47

Part No. B408517-6

10m Flexi Starter Cable



- PVC Hi-Flex Battery/Starter Cables
- Manufactured from Plain Copper Conductors
- PVC Insulation
- Temperature Range: -15°C to 70°C

Part No.	Description	Qty	Price
610510	Black 224/0.30mm 16mm ²	1	£48.70
610511	Red 224/0.30mm 16mm ²	1	£48.70
610470	Red 196/0.40mm 25mm ²	1	£62.34
610472	Black 196/0.40mm 25mm ²	1	£62.34
610512	Black 451/0.30mm 35mm ²	1	£104.84
610513	Red 451/0.30mm 35mm ²	1	£104.84
610514	Black 315/0.40mm 40mm ²	1	£124.07
610515	Red 315/0.40mm 40mm ²	1	£124.07
610516	Black 640/0.30mm 50mm ²	1	£129.05
610517	Red 640/0.30mm 50mm ²	1	£129.05
610518	Black 905/0.30mm 70mm ²	1	£164.01
610519	Red 905/0.30mm 70mm ²	1	£164.01
610520	Red 684/0.40mm 95mm ²	1	£209.04
610521	Black 684/0.40mm 95mm ²	1	£209.04

Thin Wall Autocable



Part No.	Description	Qty	Price
611000	Black 32/020 50m	1	£16.06
611002	Blue 32/020 50m	1	£16.06
611004	Brown 32/020 50m	1	£16.06
611006	Green 32/020 50m	1	£16.06
611008	Purple 32/020 50m	1	£16.06
611010	Red 32/020 50m	1	£16.06
611012	White 32/020 50m	1	£16.06
611014	Yellow 32/020 50m	1	£16.06
611016	Black 28/030 50m	1	£31.13
611018	Blue 28/030 50m	1	£31.13
611020	Brown 28/030 50m	1	£31.13
611022	Green 28/030 50m	1	£31.13
611024	Purple 28/030 50m	1	£31.13
611026	Red 28/030 50m	1	£31.13
611028	White 28/030 50m	1	£31.13
611030	Yellow 28/030 50m	1	£31.13
611032	Red/Black Twin 32/020 30m	1	£23.47
611034	Red/Black Twin 32/020 100m	1	£74.61
611036	Red/Black Twin 28/030 30m	1	£39.51
611038	Red/Black Twin 28/030 100m	1	£102.36

Single Core Autocable

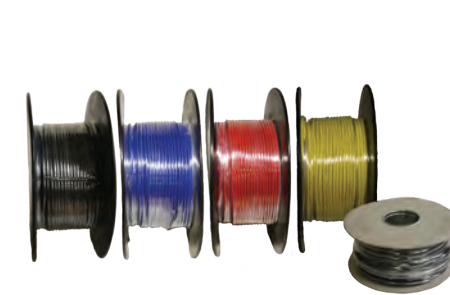

Part No.	Description	Qty	Price
610240	Black 14/0.3mm 8.75A 50m	1	£16.38
610264	White 14/0.3mm 8.75A 50m	1	£16.38
610244	Blue 14/0.3mm 8.75A 50m	1	£16.38
610247	Brown 14/0.3mm 8.75A 50m	1	£16.38
610268	Yellow 14/0.3mm 8.75A 50m	1	£16.38
610252	Green 14/0.3mm 8.75A 50m	1	£16.38
610256	Red 14/0.3mm 8.75A 50m	1	£16.38
610320	Black 28/0.3mm 17.5A 50m	1	£28.21
610332	Green 28/0.3mm 17.5A 50m	1	£23.72
610336	Red 28/0.3mm 17.5A 50m	1	£28.21

Twin Core Autocable



Part No.	Description	Qty	Price
610376	Black 9/0.3mm 5.75A 30m	1	£21.00
610382	Black 14/0.3mm 8.75A 30m	1	£22.32
610386	Black 14/0.3mm 8.75A 100m	1	£56.01
610392	Black 28/0.3mm 17.5A 30m	1	£35.72

Multicore Auto Cable

3 Core 50m 1.5mmsq Black PVC Cable



- Plain annealed flexible copper conductors
- Rubber insulated
- Generally for use at -25°C to +60°C, mains 110 - 240V

£80.55

Part No. 120233

Black 5 Core 4 x 14/0.3 PVC Cable 30m



- PVC insulation with copper conductor, for use at -30°C to +70°C - 12 & 24V systems
- Resistant to petrol, lubricating oils & diluted acids

£47.76

Part No. 610415

5 Core Thin Wall Cable 4x32/0.2mm + 1x28/0.3mm 100m

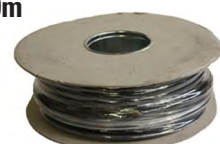

- PVC insulation with copper conductor
- Sheathed: 70°C
- Manufactured to ISO 6722-1:2011 (class B) 105°C

£164.48

Part No. 610381

7 Core Cable PVC Black 6 x 14/0.3 30m



- PVC insulation with copper conductor
- Sheathed: 70°C
- Manufactured in accordance with BS6862 Part 1 1971

£71.99

Part No. 610416

Black Convoluted Split Nylon Tubing



- Protects cables and looms against external elements
- Flame retardant
- Temperature range -40° to 120°C

Part No.	Description	Qty	Price
0-331-07	7.5NW x 50m	1	£40.88
442240	10NW x 50m	1	£43.35
0-331-13	13NW x 50m	1	£70.11
0-331-22	22NW x 50m	1	£114.83
0-331-26	26NW x 25m	1	£97.31

Convoluted Split Black Polypropylene Tubing



Part No.	Description	Qty	Price
0-328-07	7.5NW x 50m	1	£41.53
0-328-10	10NW x 50m	1	£50.61

Convoluted HD Unsplit Black Nylon Tubing



Part No.	Description	Qty	Price
0-330-07	7.5NW x 50m	1	£60.06
0-330-10	10NW x 50m	1	£67.77

12.7mm x 30m Black Spiral Binding



£32.51

Part No. 634260

6.0mm x 5m Black Spiral Binding



£3.29

Part No. B105456

6.4mm x 30m Small Spiral Rap Black



£12.65

Part No. 634264

Battery Terminal Crimping Tool



- A quick and effective way of crimping battery terminals using either a hammer or vice
- Wide throat and spring controlled punch securely holds terminal in place for added security
- Compatible with battery terminals with a cross sectional area of 6, 10, 16, 25, 35 and 50mm²

£29.38

Part No. AK422



Copper Tube Terminal Crimping Tools



- For crimping press cable eyes and pipe cable plugs, but also cable eyes made of fine-wire conductors
- For solderless electrical connections according to DIN
- Works easily and effortlessly with optimal lever transmission

Part No.	Description	Qty	Price
514652	390mm (6 - 50mm ²)	1	£116.04
B167175	660mm (25 - 120 mm ²)	1	£348.99

303pc Copper Tubing Cable Lugs Kit 6mm - 16mm²



FULL CONTENTS ONLINE

230mm Copper Tube Terminal Crimp Tool 2.5 - 16mm²

- Pressure adjustable tensioner
- Replaceable jaws
- Die material: SCM440 (HRC 42)
- Polypropylene handles

Cable Lugs

- Excellent corrosion resistance and conductivity
- Bell mouth for easy cable entry
- Used for terminating onto studs or bolts for heavy duty applications
- Terminal has an inspection hole

£88.25

Part No. 542324

252pc Copper Tubing Cable Lugs Kit 6mm - 50mm²



FULL CONTENTS ONLINE

390mm Copper Tube Terminal Crimp Tool 6 - 50mm²

- Die material: SCM440 (HRC 40-45)
- Electroplated die surface
- Handles covered with PVC

Cable Lugs

- Excellent corrosion resistance and conductivity
- Bell mouth for easy cable entry
- Used for terminating onto studs or bolts for heavy duty applications
- Terminal has an inspection hole

£171.22

Part No. 542325

Cable Lugs



- Excellent corrosion resistance and conductivity
- Bell mouth for easy cable entry
- Used for terminating onto studs or bolts for heavy duty applications
- Terminal has an inspection hole to ensure cable is fully inserted

Prices from

£3.21

Cable	Wire Range	Stud Hole						
		5.2mm	6.5mm	8.2mm	10.5mm	12.7mm	14.7mm	17.0mm
4.5mm	10mm ²	514470	514472	514335	514474	514476		
		Qty:20	Qty:20	Qty:20	Qty:20	Qty:20		
5.4mm	16mm ²		514343	514344	514478	514480		
			Qty:20	Qty:20	Qty:20	Qty:20		
6.8mm	25mm ²		514482	514345	514382	514484		
			Qty:20	Qty:20	Qty:10	Qty:10		
8.2mm	35mm ²		514486	514351	514355	514384		
			Qty:10	Qty:10	Qty:10	Qty:10		
9.5mm	50mm ²		514488	514386	514357	514342	514490	
			Qty:10	Qty:10	Qty:10	Qty:10	Qty:10	
11.2mm	70mm ²			514492	514359	514388	514494	514496
				Qty:10	Qty:10	Qty:10	Qty:10	Qty:10
13.5mm	95mm ²				514498	514500	514510	514512
					Qty:10	Qty:10	Qty:10	Qty:10

24V Heavy Duty Battery Terminals



Part No.	Description	Qty	Price
486415	Positive Terminal	10	£28.39
486420	Negative Terminal	10	£28.39

Battery Lighting Terminals



Part No.	Description	Qty	Price
515499	Negative Lighting Terminals	10	£69.08
515498	Positive Lighting Terminals	10	£72.12

Red Rubber Battery Terminal Cover



Part No.	Description	Qty	Price
1-558-99	Red Terminal Cover	10	£44.00

Black Rubber Battery Terminal Cover



Part No.	Description	Qty	Price
2-558-99	Black Terminal Cover	10	£44.00

Heatshrink Tubing Kit - Black

- Shrink Ratio: 2:1
- Shrink Temperature: 115°C
- Temperature range from: -55 to 135°C
- Resistant to chemicals & solvents

Contents

- 2.4mm x 10m
- 3.2mm x 10m
- 4.8mm x 10m
- 9.5mm x 5m
- 12.7mm x 5m
- Dispenser for 5 reels

£64.20

Part No. B510324



GREAT DEAL

Black Heatshrink Tubing



Part No.	Description	Qty	Price
B267040	2.4mm x 10m	1	£9.66
B411544	3.2mm x 10m	1	£10.71
B411545	4.8mm x 10m	1	£12.80
B411546	6.4mm x 5m	1	£13.79
B411547	9.5mm x 5m	1	£15.50
B411548	12.7mm x 5m	1	£15.74
B411549	19mm x 5m	1	£16.21
B267260	25.4mm x 5m	1	£18.25

Cable Dispenser For 5 Reels



£26.44

Part No. B100080

4.8 x 200mm Coloured Heatshrink Tubes



- Pack of 48
- Excellent flame-retardant, flexibility & insulation properties
- Suitable for the electrical insulation, bonding of cables & connectors, for corrosion-proofing of metallic rods, tubes & aerials

£13.24

Part No. 540268

Heatshrink Tubes



Part No.	Description	Qty	Price
318248-50	2.4 x 100mm	50	£2.11
318256-50	3.2 x 100mm	50	£3.00
B411553	4.8 x 100mm	50	£3.33
B411554	6.4 x 100mm	50	£4.40
318280-25	9.6 x 100mm	25	£2.33
B411556-10	12.7 x 100mm	10	£1.20
318302-10	19.1 x 100mm	10	£1.77

1.2m Heat Shrink Tubing with Adhesive



Part No.	Description	Qty	Price
B811424	4.0mm	1	£2.13
B811386	8.0mm	1	£2.85
B811394	12.0mm	1	£3.00
B811408	16.0mm	1	£3.63
B811416	24.0mm	1	£5.76

DT Connectors



Kit Contents:

- DT Plug Series
- DT06-2S (x16)
- DT06-3S (x2)
- DT06-4S (x2)
- DT06-6S (x2)

- DT Receptacle Series
- DT04-2P (x10)
- DT04-3P (x2)
- DT04-4P (x2)
- DT04-6P (x2)

- Solid Contacts
- 0462-201-16141 (x60)
- 0460-202-1614 (x60)
- Blanking Plug
- 114017 (x10)

- Wedge
- W2S (x16)
- W3S (x2)
- W4S (x2)
- W6S (x2)
- W2P (x10)
- W3P (x2)
- W4P (x2)
- W6P (x2)

Part No.	Description	Qty	Price
600620	DC Connectors with Crimping Tool	1	£241.66
600621	DC Connector Assortment	1	£151.89

Procell Batteries

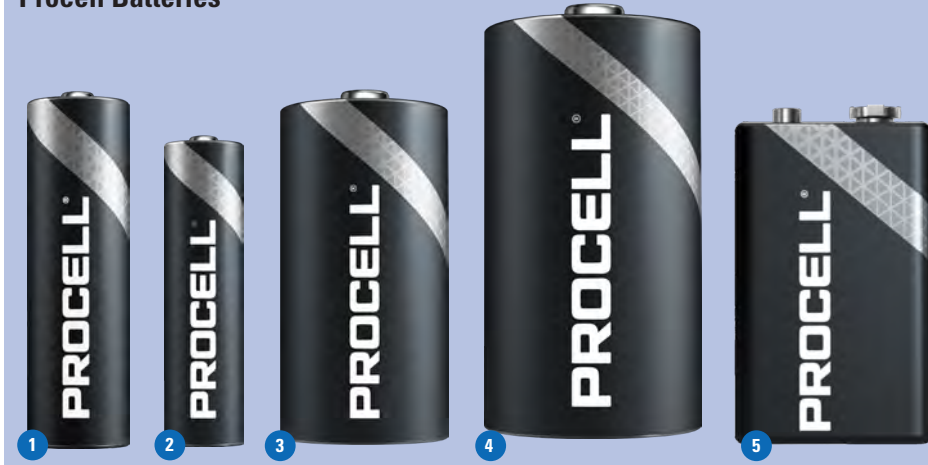

- Reliable long-lasting power
- Excellent resistance to corrosion
- Quality warranty on each battery
- Operating temperature from -4°F to 129.2°F

Part No.	Description	Qty	Price
1	800190 1.5V AA	10	£8.38
2	800192 1.5V AAA	10	£7.46
3	800194 1.5V C	10	£13.78
4	800196 1.5V D	10	£17.31
5	800198 9V	10	£26.48

Button Batteries

3v Varta Button Batteries



Part No.	Description	Qty	Price
B165673-10	CR2032	10	£16.68
B165674-10	CR2025	10	£16.91

3v CR2450 Lithium Coin Button Battery



- Low self discharge for a long shelf life
- Resistant to vibration, shock and acceleration
- Excellent reliability and a high capacity
- Applications include calculators, car keys & vernier gauges

£8.14

Part No. 800220

1.5v LR44 Alkaline Battery



- Suitable for electronic, medical, security devices & other portable electronic devices
- High capacity, non-rechargeable
- Long storage life & long operational life

£5.19

Part No. 800222

AA Rechargeable Batteries



- Pack of 4
- All batteries are pre-charged and ready to use right out of the pack
- Retains up to 80% of total power after 12 months when left idle
- Up to 500 charges or 6 years whichever comes first
- Operating temperature from -20°C to 50°C

£16.52

Part No. 800188

6v Lantern Battery



- Provides an economical power source for low-drain devices
- Continuous supply of low power, an ideal choice for products that don't draw a lot of power such as radios, remote controls, wall clocks, LED torches and battery powered toys

£3.10

Part No. 612286

Battery Chargers and Boosters

SEE PAGES 256-257



Torches



One charging system for all via USB



- Worklamp detaches from headband



Torch Charging Accessories



	1. Slimlite	2. Pen Light LED 7+1	3. Pocket Lux Slim LED	4. Pocket Lux Bright	5. Pocket DeLux Bright	6. Pocket DeLux Sun	7. LED 2-in-1 Multifunction Head Torch	8. 10W LED Floodlight
Part No.	B365815	B200559	B244406	B206956	B206958	B206957	B335506	B341709
Brightness at 0.5m	900/450Lux	100 Lux	900 Lux	450 Lux	400 Lux	2000 Lux	500 Lux	1500 Lux
Running Time	3/6 hours	3.5 hours	4/7 hours	3 hours	3 hours	4 hours	4 hours	3 hours
Charging Time	5 hours	3 hours	5.5 hours	4 hours	4 hours	4 hours	4 hours	5.5 hours
IP Rating	IP42	IP20	IP20	IP20	IP20	IP20	IP65	IP65
Price	£26.39	£21.10	£39.61	£39.61	£35.64	£38.49	£21.63	£43.60

Part No.	Description	Qty	Price
B201071	USB Cable	1	£2.65
B198629	USB Plug	1	£7.46
B371151	USB Car Charger	1	£7.17
B485125	USB Plug & USB Cable	1	£9.38
B215102	USB Cable, Plug and Car Charger	1	£15.49

Headlights

 448 B179868-10	 453 B179884-10	 453 Premium B098182-10	 472 B080891-10	 472CP 110737	 472 Premium B098185-10	 499 B108038-10
 499 SuperBlue 110748	 499 Premium B098188-10	 448 Premium B098180-10	 H8 B174487	 H9 B174488	 H11 B174489	 H15 B098739
 HB4 B144003						

Switches & Warning Lights

 286 B190012-10
--

Interior

 256 B368067-10	 265 110263	 270 B179850	 272 110717	 273 110264	 281 110274
--	--	---	--	--	--













Front Fog Lights

 448 B179868-10	 453 B179884-10	 453 Premium B098182-10	 448 Premium B098180-10	 499 B108038-10
 499 SuperBlue 110748	 499 Premium B098188-10	 H8 B174487	 H11 B174489	 H16 B216487
 HB4 B144003				

Day Time Lights

 380 110318	 380W B144357-10	 382 B154148-10	 382A B171082-10	 382W B144358-10	 382WA B000581-10
 433D B165189-10	 499 B108038-10	 499 SuperBlue 110748	 499 Premium B098188-10	 H8 B174487	 H15 B098739

Side Marker/ Front Indicator

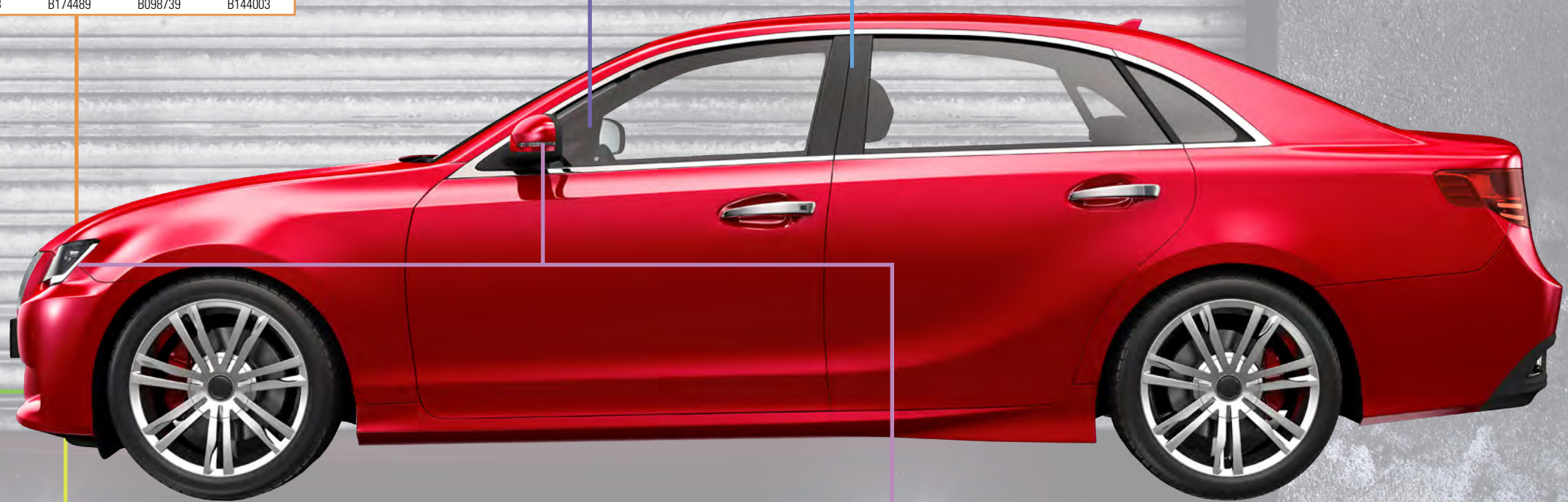

 207 B154120-10	 207 LongLife B148327-10	 209 110232	 233 B179973-10	 245 110245	 281 110274	 335 110298
 380 110318	 382 B154148-10	 501 110374	 504 B154164-10	 581 B154156-10	 921 110422	



Parking Lights

				
207 B154120-10	207 LongLife B148327-10	233 B179973-10	245 110245	380 110318
				
380W B144357-10	382W B144358-10	469 B112938-10	501 110374	504 B154164-10

Rear Indicators

			
335 110298	382 B154148-10	382W B144358-10	382WA B000581-10
			
433D B165189-10	921 110422	581 B154156-10	

Tail Lights

					
207 B154120-10	207 LongLife B148327-10	209 110232	245 110245	380 110318	380W B144357-10
					
381 110320	382 B154148-10	382W B144358-10	501 110374	566 110720	921 110422

Brake Lights

				
335 110298	380 110318	380W B144357-10	381 110320	382 B154148-10
				
382W B144358-10	433D B165189-10	501 110374	566 110720	921 110422



Reversing Lights

		
335 110298	382 B154148-10	382W B144358-10
		
469 B112938-10	433D B165189-10	921 110422

Rear Fog Lights

			
335 110298	380 110318	382 B154148-10	382W B144358-10
			
433D B165189-10	566 110720	921 110422	

Number Plate Lights

				
207 B154120-10	207 LongLife B148327-10	233 B179973-10	239 B179949-10	245 110245
				
270 B179850	273 110264	501 110374	504 B154164-10	

Panel Bulbs



Standard Bulbs



Brake, Indicator, Reverse, Rear Fog Lights



Festoon Bulbs



Headlights

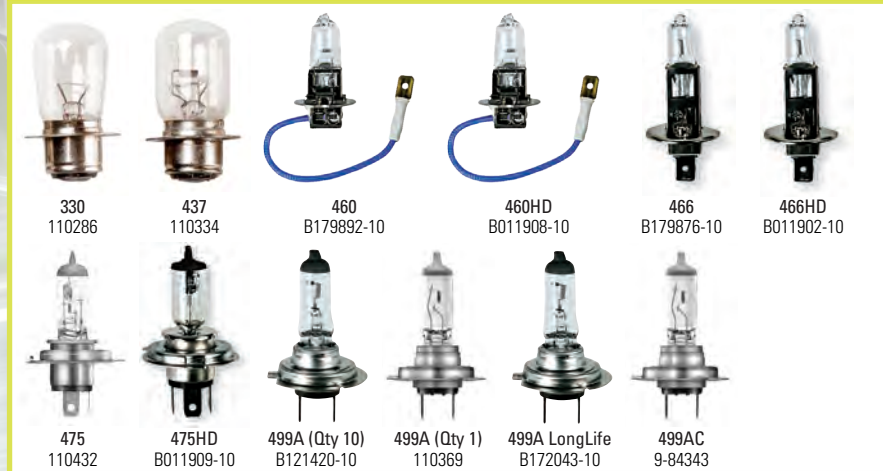

Side & Tail Lights



Brake & Tail Lights



12/24V Flood Lamps 9 x 3w LEDs



- Low current draw: 1.5A at 12V DC
- Supplied with stainless steel adjustable bracket and 300mm flying lead
- 1700 lumens
- Protected to IP67

Part No.	Description	Qty	Price
128860	Square	1	£12.47
128864	Round	1	£12.47

12V/24V LED Warning Beacon with 3 Bolt Fixing



- 3-Function control allows for different LED flash configurations
- Heavy-duty ABS base
- Quick release UV stabilised dome will not fade if exposed to prolonged sunlight
- Direct mounting beacon pre-drilled with 3 x 6.5mm holes

£31.95

Part No. 730502

12V/24V LED Warning Beacon with Magnetic Base



- 3-Function control allows for different LED flash configurations
- Heavy-duty ABS base
- Quick release UV stabilised dome will not fade if exposed to prolonged sunlight
- Fitted with six powerful magnets, strong enough to cope with normal road speeds
- Supplied with 3m coiled flex and universal vehicle accessory socket plug

£34.95

Part No. 730506

12V/24V SMD Green LED Warning Beacon with 12mm Bolt Fixing



- Green colour beacon for use on plant vehicles to indicate that a seatbelt is being worn
- Single-point mounting beacon suitable for direct mounting to vehicle roof using 12mm bolt
- Fitted with 36 x 1W high power SMD LEDs
- 120 flash per minute pattern
- Fully meets ECE R10 regulations
- IP Rating of IP66

£49.95

Part No. 730510

12V/24V SMD Green LED Warning Beacon with Flexible Spigot Base



- Green colour beacon for use on plant vehicles to indicate that a seatbelt is being worn
- Flexible spigot beacon suitable for mounting on spigot brackets, part numbers 730520 & 730522
- Fitted with 36 x 1W high power SMD LEDs
- 120 flash per minute pattern
- Fully meets ECE R10 regulations
- IP Rating of IP66

£49.95

Part No. 730512

12V/24V LED Warning Beacon with 12mm Bolt Fixing



- 3-Function control allows for different LED flash configurations
- Heavy-duty ABS base
- Quick release, UV stabilised dome will not fade if exposed to prolonged sunlight
- Single point mounting beacon suitable for direct mounting to vehicle roof using 12mm bolt

£32.95

Part No. 730500

12V/24V LED Warning Beacon with Flexible Spigot Base



- 3-Function control allows for different LED flash configurations
- Heavy-duty ABS base
- Quick release UV stabilised dome will not fade if exposed to prolonged sunlight
- Flexible DIN element suitable for agricultural vehicles where standard beacons may be broken

£33.95

Part No. 730508

Beacon Brackets



- Mounting bracket for DIN spigot beacons
- Constructed of tough and lightweight materials for extended life

Part No.	Description	Qty	Price
1	730520 Beacon Bracket 2 x Bolt Fixing	1	£10.95
2	730522 Beacon Bracket Vertical Fixing 90deg	1	£10.95

40 SMD LED Foldable Cordless Under-Bonnet Rechargeable Lamp



- Robust design with built-in spring loaded telescopic mounting brackets
- Soft padded hooks provide good protection against the bonnet
- 40 SMD LEDs give complete engine bay illumination
- Charging time – 6 hours
- Lumen output – 1400lm
- Foldable design for easy storage when not in use
- Light source rotates within clamps to direct as required
- Includes battery level indicator, mains charger and in-car charger

£84.69

Part No. LED136

70W 110V SMD LED Portable Floodlight

- Portable floodlight in die-cast aluminium housing with on/off switch and stand
- SMD LED technology allows ultra-bright illumination whilst still keeping costs lower than traditional halogen tubes
- Even spread of light across a 110° angle
- IP54
- 1 year guarantee
- Supplied with power cable and 16A 110V plug

£75.95

Part No. LED097

20W SMD LED Rechargeable Portable Floodlight - Fold Flat

- Innovative swivel function enables floodlight to rotate 360° and fold flat
- Floodlight houses 36 super bright SMD LEDs providing up to 1200 lumen output with 110° spread of light
- High quality 5.2Ah Lithium-ion battery for longer life and a much slower discharge than traditional Ni-MH batteries
- IP44
- 1 year guarantee
- Supplied with mains charger

£59.95

Part No. LED171

Fluorescent Tubes



Part No.	Description	Qty	Price
118228	18" 15W Coolwhite	25	£68.90
118215	2ft 13W Coolwhite	25	£43.05
118219	2ft 18W White	25	£51.92
118204	2ft 18W Warm White	25	£45.58
118206	2ft 18W Coolwhite	25	£48.10
118230	3ft 30W Coolwhite	25	£65.66
118325	3ft 30W T8 Sylvania	25	£191.27
118225	4ft 36W Coolwhite	25	£63.16
118317	4ft 36W T8 Sylvania Coolwhite	25	£133.82
118255	5ft 58W Coolwhite	25	£77.17
118315	5ft 58W Sylvania Coolwhite	25	£154.90
118289	5ft 58W Blue Fluorescent	10	£182.86
118236	6ft 70W Sylvania Bipin White	25	£139.48

Fluorescent Tube Starter Switches



- For single & twin lamp operation
- Reliable and fast starting

Part No.	Description	Qty	Price
ED306	4-65w	10	£4.50
ED308	70-125w	10	£6.69

Dichroic Bulbs



- Commonly used in coaches, buses, boats and low voltage garden lights

Part No.	Description	Qty	Price
110140	24v 10w 50mm	1	£2.84
9-74479	2-Pin Plug & Lead	1	£2.05

Extension Lead 4 Gang x 2m Cable (13A)



- BS1363/A Compliant
- 240V Mains Voltage
- 13A Current rating

£5.87

Part No. ED910

Extension Reel 230v/13A 25m



- For use indoors in all industries
- Semi-enclosed case for ease of winding
- 4 sockets and 25 metre cable
- Thermal cut-out protection
- Built in cable guide
- Rest button

£49.45

Part No. 488052

13A White Plugs



MAINS FUSES – SEE PAGE 9

- Pack of 10
- Rubber domestic 3 pin white plugs

£31.67

Part No. 488005

230v Plugs & Sockets



Part No.	Type	Amps	Qty	Price
WP24016	Plug	16A	1	£3.86
WP24032	Plug	32A	1	£6.45
WC24016	Socket	16A	1	£4.13
WC24032	Socket	32A	1	£6.90

230v 3-Way Splitter



- 3-Way splitter 230V, allows splitting of a maximum current of 16A
- Fitted with one 2P+E input and three output connectors
- IP44 Rated

£19.84

Part No. WTWS16A

16A/13A Socket Adaptor



- Socket adaptor with 2P+E plug 16A to 3-Pin standard UK plug 13A
- IP44 Rated
- Conforms to EN60309 and BS1363

£7.09

Part No. W1613PS

13A/16A Trailing Plug & Cable Set



- Trailing plug & cable fitted with a 230V 13A standard UK plug and 2P+E socket rated at 230V 16A
- H05VV-F 3G 1.5mm Section cable, 350mm in length
- IP20 Rated

£8.00

Part No. WSP1316

16A/13A Trailing Sockets & Cable Sets



- Fitted with a 230V 13A standard UK socket and 2P+E plug rated at 230V 16A
- H05VV-F 3G 1.5mm Section cable, 350mm
- IP20 Rated

Part No.	Description	Qty	Price
WPS16131	1 Socket	1	£8.00
WPS16132	2 Sockets	1	£9.92

15m Mains Unit with RCD



- Fitted with three UK standard 230V 13A sockets and a 2P+E Plug rated at 230V 16A
- Fitted with a residual current circuit breaker 25A 2-pole and a mini circuit breaker 16A 2-pole
- 15m H05VV-F 3G cable
- IP44 Rated

£64.95

Part No. WSC16133

14m Extension Lead



- Extension cable fitted with 13A 240V plug and single 240V socket
- Conforms to BS EN 60309

£29.95

Part No. EL15240

230v Extension Leads



- Extension cable fitted with 2P+E plug and socket connectors rated at 230V 16A with protective end cover
- IP44 Rated

Part No.	Description	Qty	Price
EL1523016	14m 16A 1.5mm	1	£27.95
EL2523016	14m 16A 2.5mm	1	£39.95

230v 15m Cable Reel with RCD



- Fitted with three UK standard 230V 13A sockets, a 2P+E Plug 230V 16A and 2 x USB 5V 2.1A Ports
- Residual current circuit breaker 25A 2-pole and a mini circuit breaker 16A 2-pole
- IP44 Rated

£79.77

Part No. WSPC1633U

110v Portable Transformers



- 110V Transformer with tool rated performance suitable for intermittent running of power tools and continuous running of lighting products within specified capacity
- IP54 Rated unit with case manufactured from GRP and insulated to class H
- Fitted with thermostatic overload protection

Part No.	Rating	Sockets	Qty	Price
WST1500	1500VA	2 x 16A	1	£73.95
WST3000	3000VA	2 x 16A	1	£87.31
WST5000	5000VA	2 x 16A, 1 x 32A	1	£199.95

110v Portable Vented Transformer



- 110V Transformer with continuous 3000VA output which is ideal for 110V heaters and power tools that require a continuous load
- IP20 Rated unit with steel casing and insulated to Class 1 with ventilated outlets
- Fitted with thermal overload protection
- Supplied with 1 x 16A plus 1 x 32A socket

£259.95

Part No. WST5000MV/2

110v Extension Leads



Part No.	Description	Qty	Price
EL15110	14m 16A 1.5mm	1	£27.95
EL25110/16	14m 16A 2.5mm	1	£39.95
EL25110/32	14m 32A 2.5mm	1	£47.95

110v Plugs & Sockets



Part No.	Type	Amps	Qty	Price
580266	Plug	16A	1	£3.71
WP11032	Plug	32A	1	£6.45
580268	Socket	16A	1	£5.41
WC11032	Socket	32A	1	£6.45

10W SMD LED Telescopic Floodlight - 110v

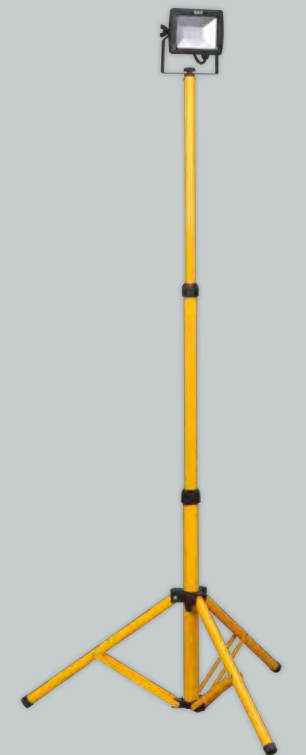

- Extra slim, die-cast aluminium housing with foldaway tripod legs
- SMD LED technology allows ultra-bright illumination whilst still keeping costs lower than traditional halogen tubes
- Even spread of light across a 110° angle
- Supplied with 16A 110V plug
- IP54 Rated
- 800 Lumen

£59.95

Part No. LED099

110v 3-Way Splitter



- 110V 3-Way Splitter, 16A
- IP44 Rated
- 2P+E Connector

£19.84

Part No. WSTWA

110v 4-Way Splitter Box



- 4-Way 16A Splitter Box with 1.5mm cable and 16A plug
- CEE Connector
- IP44 Rated

£37.95

Part No. WSSB16

Super 6+ Multi Spray



- Extremely high water displacement properties
- For dissolving rust, lubrication and protection during servicing, maintenance and repair
- Protects against corrosion and eliminates squeaking
- Excellent creep properties
- Temperature range: -40 to 150°C

Part No.	Description	Qty	Price
B408449	400ml	1	£5.23
B408449-15	400ml	15	£62.69
B408773	5L	1	£33.00

Brake Cleaner



- For cleaning and degreasing of brake and clutch systems
- Dries quickly and is residue free
- Can be sprayed in different positions including upside down
- Does not damage varnishes, rubber or plastic
- Free from silicone, AOX, cadmium, acetone, hydrocarbons, chlorofluorocarbons, lead and aromatics

Part No.	Description	Qty	Price
371150	500ml	1	£1.98
371150-15	500ml	15	£28.99
B365882	5L	1	£14.72
820342	5L x 4 with Sprayer	1	£53.90

400ml Multispray Premium Spray



- Movable nozzle
- Choose between precision spraying and surface application
- One product for different purposes - Effective lubricant, rust remover, contact spray and corrosion protection
- Prevents squeaking and malfunctioning of machines, equipment, etc
- Protects against corrosion and preserves metal
- Quickly loosens rusted parts such as screws, bolts or hinges
- Expels water and stops cracking

£6.99
Part No. B408448

Duck Oil



- Silicone-free
- Exceptionally low surface tension means it can easily penetrate, lubricate and protect with no need to dismantle machinery and parts

Part No.	Description	Qty	Price
510313	500ml Aerosol	1	£9.36
510249	5L	1	£55.59

500ml High Pressure Lubricant

- Good lubrication properties to reduce friction
- Durable synthetic lubricant with high polymer content
- Very strong adhesion and high pressure resistance
- Provides thorough lubrication due to very high creep capacity
- Effective corrosion protection

£5.01
Part No. B153427

500ml PTFE High Performance Lubricant

- Lubrication of components exposed to high pressure, impacts and vibrations such as gear wheels, sprockets and door bolts
- Special additives ensure re-hydration and long-term lubrication
- Temperature range: -30 to 250°C

£7.94
Part No. B408461

400ml Battery Pole Grease Spray

- For maintenance of battery terminals, clamps etc
- Long-term protection against corrosion and oxidation
- Improves current flow and prevents malfunctions
- Eliminates current leakage and voltage drop
- Temperature range: -25 to 120°C

£6.59
Part No. B408458



500ml Wire Cable & Gear Wheel Lubricant

- Lubrication and protection of cables, winches, gears, chains, guide rails, turntables etc
- Suitable for components that are exposed to high pressure and extreme load
- Free from silicone, resins and acids
- Temperature range: -30 to 150°C

£6.56
Part No. B408462

400ml Silicone Spray NSF

- NSF H1 registered: suitable for use in the food processing industry
- With 100% pure Silicone - content in the lubricating film
- Lubricates, preserves, cleanses and impregnates
- Eliminates and prevents squeaking, creaking and friction noise
- Protects against premature ageing

£6.56
Part No. B408451

400ml Universal White Grease Spray

- Universal lubrication of moving parts such as hinges, joints, slide rails, shafts etc
- Good adhesion, even on vertical surfaces
- Water repellent
- Protects against corrosion
- Free of silicones, resins and acids
- Temperature range: -20 to 120°C

£6.59
Part No. B408453

400ml Motorcycle Chain Spray

- Ideally suited for high speed turning chains
- Excellent lubricating and creep properties
- Suitable for O, X and Z rings
- Reduces friction and prevents premature wear
- Protects against corrosion
- Temperature range: -30 to +110°C

£5.94

Part No. B409468

50ml Key Cylinder Care Spray

- Maintenance, lubrication and protection of rotary cylinders and locking mechanisms
- Prevents premature wear and tear
- Contains PTFE
- Resistant to water and oxidation
- Temperature range: -50 to 140°C

£4.58

Part No. B146700

400ml Silicone Spray

- Lubrication and care of plastic parts, door and window seals and hinges
- Reduces and prevents cracking and squeaking
- Prevents charging of static electricity, premature ageing and undesirable freezing
- Protects against corrosion and oxidation
- Temperature range: -30 to 200°C

£6.56

Part No. B371757



400ml Aluminium Grease Spray

- Lubrication and protection of screw and bolt connections that are exposed to high temperatures e.g. exhaust pipes, turbo's, oxygen sensors
- High pressure resistance
- Protects against corrosion and oxidation
- Free of silicones and acids

£6.59

Part No. B408454

400ml Silicone Grease Spray

- Lubrication and care of roller bearings, hinges, electric plug-in connectors, trailer sockets, switches etc
- Extremely high lubricating properties
- Effective anti-corrosion protection
- Resistant to oxidation
- Waterproof
- Temperature range: -30 to 200°C

£8.72

Part No. B408460

EP2 Lithium Grease



- For automotive and industrial ball and roller bearing applications
- A high melting point, smooth, multi-purpose, extreme pressure (EP) grease based upon lithium soap
- Wide temperature range -15° to 120°C

Part No.	Description	Qty	Price
510202	400g	1	£3.88
510206	400g	12	£46.77
501228	500g	1	£5.64
501230	3kg	1	£26.43

500g Renolit Red Rubber Grease



- For automotive brake assemblies, hydraulic and rubber components etc

£12.45

Part No. VANVC188

226g Petroleum Jelly



£6.11

Part No. 510296

400ml Copper Lubricant Spray

- Lubrication of screw connections, plug connectors & exhaust systems etc
- Pure copper base
- Protects against corrosion, rust etc
- Temperature range: -35 to 1100°C
- Free of silicones, resins and acids

£5.23

Part No. B408455



500g Anti-Seize Copper Compound



- Used on threaded parts, gaskets and packing to prevent seizure and galling
- Protects against seizure even in extreme conditions of temperature and pressure
- Temperature range: -40 to 1100°C

£5.78

Part No. 750848

70g Copper Slip Grease



- A high performance lead free anti-seize compound which is designed for application to threads of nuts and bolts prior to assembly to ensure easy release, without damage, even after long periods in adverse conditions

£4.21

Part No. 510208

500g Aluminium Graphite Anti-Seize Compound



- Protects against seizure even in extreme conditions of temperature and pressure
- Temperature range: -40 to 1100°C

£13.05

Part No. 9-101521

400ml Drilling & Cutting Oil

- For drilling, thread cutting and turning
- Suitable for metal, light and heavy aluminium, copper, stainless steel and brass
- Reduces heat generation
- Extends the life of drilling and cutting tools

£5.92

Part No. B911371



400gm Supercut Fluid

- A hand-applied metal-cutting lubricant
- Recommended for use with cutting tools
- Excellent cutting performance
- High viscosity formula
- Excellent adhesion to the tool
- Low odour, solvent-free
- Can be used on all metals
- Mineral oil free

£17.73

Part No. 510266



Grease Guns & Accessories

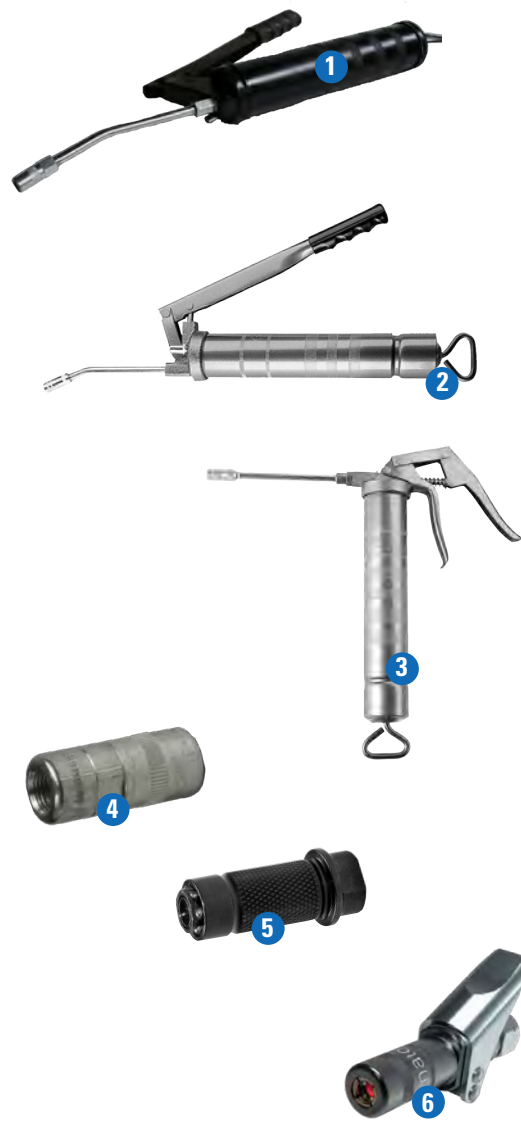

Part No.	Description	Qty	Price
1	734259 500cc Professional Side Lever	1	£10.77
2	734261 500cc Heavy Duty Side Lever	1	£18.44
3	734916 500cc Pistol Grip	1	£27.62
4	734250 4 Jaw End Connectors	10	£20.76
5	734500 Quick Release Grease Coupler	1	£31.81
6	B408939 Safety Lock Grease Coupler	1	£26.13

Grease Gun Hose

Part No.	Description	Qty	Price
734238	300mm HP Rubber Hose	1	£2.96
734240	500mm HP Rubber Hose	1	£3.95

Lever Operated Screw Type Grease Gun



- Cartridge holder opens without tools, reusable screw cap
- Fast and clean loading and removal of grease
- Optimal use of all the grease in the cartridge
- Working pressure: 400 bar (5,800 psi)
- Maximum pressure: 800 bar (11,600 psi)
- Suitable for grease cartridges with Lube-Shuttle® connection
- Hose connection thread: M10 x 100

£36.01

Part No. B129309

400g Universal Lithium Grease Cartridge Screw Type

- Lubrication of plain bearings, ball bearings and roller bearings under normal load
- For hot and cold plain bearings, running and supporting rollers in all roller frames and spindles
- Reliably reduces friction and wear
- Prevents jamming and cold welding
- Good corrosion protection
- Good sealing and protective properties in wet and dusty environments
- Lithium thickened with corrosion inhibitors and AW additives

£3.11

Part No. B215650



H1 Straight Grease Nipples DIN71412



Part No.	Description	Qty	Price
13617-25	M6 x 1mm	25	£6.26
13625-25	M8 x 1mm	25	£7.44
734284	M8 x 1.25mm	50	£10.69
13633-25	M10 x 1mm	25	£7.32
13722-25	UNF 1/4"	25	£7.45
13730-25	UNF 5/16"	25	£7.96
13749-25	UNF 3/8"	25	£9.97
734214	1/8" BSP	100	£21.20
931036-25	G 1/4" BSP	25	£15.04

H2 45° Grease Nipples DIN71412



Part No.	Description	Qty	Price
13641-25	M6 x 1mm	25	£13.06
13650-25	M8 x 1mm	25	£14.39
13668-25	M10 x 1mm	25	£13.26
931038-25	G 1/4" BSP	25	£30.15
936574-25	G 1/8" BSP	25	£16.40

H3 90° Grease Nipples DIN71412



Part No.	Description	Qty	Price
13684-25	M6 x 1mm	25	£13.35
13692-25	M8 x 1mm	25	£13.84
13706-25	M10 x 1mm	25	£14.83

M6 x 1mm H3 90° Twin Grease Nipples

- Pack of 25



£18.94

Part No. 140537-25

Mobile Air Grease Unit 12.5g to 18kg Complete

- 2m delivery hose

£772.66

Part No. 734900



Mobile Air Grease Unit 50Kg Complete

- 3m delivery hose

£927.93

Part No. 734902



16Kg Multi Pressure Grease Bucket Pump

- Includes a 16L leak proof, all steel oval shaped bucket with carry handle and foot rest for easy handling and stability
- Heavy duty, high capacity pump with 3 alternative lever positions which can be used under any operating conditions and with all types of lubricants (winter/summer, high or low viscosity grease and oil)
- Maximum pressure range: 175-350 bar

£303.36

Part No. 734510



1/4 BSP Control Valve and Z Swivel Female End



£92.08

Part No. 720275

1/4 BSP Z Swivel



£58.86

Part No. 720279

16L Oil Bucket Pump

- Include a 16L leak proof, all steel oval shaped bucket with carry handle and foot rest for easy handling and stability
- For dispensing high viscosity lubricants
- 1.5m rubber hose with shut off valve and 135° angled nozzle
- Pump delivery per stroke: 100cc

£266.96

Part No. 734512



High Pressure Grease Bucket Pump for 12.5 - 18Kg Kegs

- Mount directly onto original grease kegs
- Maximum pressure: 350 bar (5,000 psi)
- Delivery per stroke 2cc
- Equipped with carrying handle, cover with pump adaptor, follower disc and 1.5m high pressure hose with rigid stem and four-jaw hydraulic connector

£181.52

Part No. 734514





Part No.	Description	Qty	Price	Part No.	Description	Qty	Price		
1	B243442	50ml Orange Gasket	1	£30.35	6	B243191	24g Screw Lock High	1	£13.15
2	B243443	50ml Green Gasket	1	£30.35	7	B243190	60g Screw Lock High	1	£14.54
3	B243445	50ml Thread Sealant	1	£10.56	8	B243444	50ml Hydraulic Sealant	1	£8.80
4	B243192	24g Screw Lock Medium	1	£11.81	9	B243441	60g Retainant Tall	1	£13.21
5	B243193	60g Screw Lock Medium	1	£13.21					



Part No.	Description	Qty	Price	
1	B244119	5g Super Glue NSF	1	£3.29
2	B243427	20g Super Glue	1	£6.35
3	B243426	20g Super Glue Gel	1	£9.59
4	B304582	400ml Spray Adhesive	1	£4.78
5	B409515	25ml Fast Plastic Adhesive SUPERspeed	1	£7.92
6	B409518-2	50ml Fast Plastic Adhesive	2	£20.99
7	B103481	50ml Gun for Fast Plastic Adhesive	1	£39.68
8	B103480-12	Mixing Tips for Fast Plastic Adhesive	12	£6.60
9	B207814-12	Mixing Nozzles for 25ml Fast Plastic/Power Weld	12	£6.77
10	B409841	150ml Primer for Fast Plastic	1	£10.55
11	B409932	25ml Double Syringe Power Weld Structural Adhesive	1	£19.54

1L Thixofix Adhesive with Spatula



£41.92

Part No. 487120

5L SF115 Contact Adhesive



- SF115 is a one part, modified elastomer contact adhesive for use with rubber and PVC

£34.94

Part No. 999981

1L CT468 Contact S Adhesive



- Fully developed bond is completely resistant to water, mild acids and alkalis

£9.65

Part No. 9-91857

20g Cyno40 Low Viscosity Adhesive

- Instant bonding adhesive
- Cures very quickly
- Provides extremely fast fixing and will bond a huge variety of materials

£6.36

Part No. 482462

15ml Araldite Rapid Twin Tube Pack



- Perfect for complicated jobs which require adjustment thanks to a long working time

£9.91

Part No. 487110

400ml MA300 Plexus with Nozzle

- This adhesive combines high strength and stiffness with the ability to bond a wide range of materials



£51.11

Part No. 487170

28ml Syringe Rapid Cure Epoxy D300



- 1:1 solvent free, adhesive designed to bond or repair most materials such as wood, metal, glass, ceramic, plastics and rubbers

£6.44

Part No. 750796

10g Loctite 3090 Adhesive



- Fast curing
- Gel-based: non-drip formula allowing vertical and overhead application

£24.65

Part No. 482217

Double Bubble Fast Cure Epoxy (50 Sachets)

- Bonds to a wide variety of materials
- Cures rapidly to give handling strength in 5mins



£67.86

Part No. 471717

50ml Delta D55 High Strength Retaining Adhesive



- Used for retaining bushings and sleeves on housings or shafts, bearings, keys and splines particularly where bond gaps can approach 0.25mm (0.01")

£12.54

Part No. 750720

200ml Black Liquid Gasket (RTV)

- Temp resistance -40°C to +285°C
- Ideal for sealing of heating installations, sealing in pumps, engines and in general all sealing applications that require high temperature resistance



£10.62

Part No. B343963

310ml Black RTV Silicone Sealant

- Premium quality specially formulated for automotive and industrial use
- Bonds and seals metals, glass, rubber, etc
- Flexible and resistant to transmission, cooling and lubricating fluids



£6.67

Part No. 750868

310ml Silicone Sealant

- For sealing glass, aluminium and metal
- Multi-purpose acetoxo: cures quickly to provide a permanently flexible, high strength waterproof seal



Part No.	Description	Qty	Price
482258	Clear	1	£4.93
482256	Black	1	£4.93
482263	White	1	£4.93

300ml PU Sealant

- Bonding & sealing on various surfaces such as metal, wood, plastic and stone
- Can be sanded & painted over
- Lasting & durable
- Temperature range: -40 to +90°C



Part No.	Description	Qty	Price
B407557	White	1	£4.46
B407651	Grey	1	£4.46
B407648	Black	1	£4.46

310ml White VIP Ms-Polymer Seam Sealer

- New generation high quality hybrid polymers
- Cures under the influence of air
- Can be painted after 15 minutes, even when wet
- Fast drying, contains no isocyanates, solvents or silicone
- Remains flexible



Part No.	Description	Qty	Price
34501	White	1	£11.20
34503	Black	1	£10.62

285ml White Oil Based Mastic Sealant

- Typically used to seal composite sectional panels and low movement vertical building joints



£3.13

Part No. 482331

310ml 1130 Betaseal Sprint Cartridge

- Medium viscous, non-conductive, High modulus, glass bonding adhesive
- 2 hour safe drive away time for one airbag and 4 hour for twin airbag



£10.88

Part No. 550085

Pneumatic Multi-Caulking Gun



- Ideally suited for the processing of bodywork sealant, PU sealant, weld sealant and more
- The built-in pressure regulator reduces the inlet pressure to the correct working pressure (7.5 bar)
- The amount of sealant and air can be infinitely adjusted with the two adjusting screws, so that the sealant can be optimally processed for every application
- Plastic housing
- Only suitable for 310ml cartridges
- Preheat sealants with high viscosity such as Window Adhesive to ensure proper operation



£323.97

Part No. B113061

Nozzles for Multi-Caulking Gun - 12pcs



£31.81

Part No. B113062

300ml Sprayable Weld Sealant



- Can be used in body, container and car construction
- Good resistance to weather influences, UV rays
- Permanently elastic, fast drying
- Sprayable wet on wet
- Good adhesion, both on galvanized, bare, primed or painted metal plates, aluminium and thermoplastics (except PE, PP, PTFE)
- Can be used for both seam sealing and surface finishing

£8.46

Part No. B372802

Mastic Guns



Part No	Description	Qty	Price
1	552280 310ml	1	£6.28
2	552282 400ml	1	£9.93
3	552285 310/400ml Heavy Duty	1	£18.55

Multiprimer Applicator Brushes



£8.73

Part No. B401226-12

Sika Primers



Part No.	Description	Qty	Price
482358	250ml Sika 206 Primer Black with Brush	1	£44.24
482362	250ml Sika 210T Plastic and Metal Primer	1	£36.07

Sikaflex®-221

- High quality multi-purpose non-sag 1-C polyurethane sealant
- Cures on exposure to atmospheric humidity: forms a durable elastomer
- Bonds well to a wide variety of substrates: metals, metal primers, paint coatings (2-C systems), ceramic materials and plastics
- Non-corrosive
- Can be sanded and painted over
- Elastic
- NSF approved for incidental food contact



Part No.	Description	Qty	Price
482298	300ml Black	1	£12.48
482306	300ml Grey	1	£12.48
482302	300ml White	1	£12.48
482291	400ml Black Sausage	1	£14.35
482500	600cc Black Sausage	1	£17.47

Sikaflex®-252

- 1-C formulation
- Bonds well to a wide variety of substrates: timber, metals, sheet steel, metal primers and paint coatings (2-C systems), ceramic materials and plastics
- Good gap-filling properties
- Capable of withstanding high dynamic stresses
- Vibration damping
- Non-corrosive
- Electrically non-conductive
- Can be painted over
- Elastic



Part No.	Description	Qty	Price
482301	300ml Black	1	£17.98
482304	300ml White	1	£18.78
482369	600cc White	1	£20.65

Sikaflex®-255 FC

- 1-C formulation
- High performance direct glazing adhesive with gap filling capabilities
- Cures on exposure to atmospheric humidity and form a durable elastomer
- Elastic
- Fast curing
- Wide adhesion range on most relevant substrates



Part No.	Description	Qty	Price
482299	300ml Black	1	£12.47
482305	400cc Black	12	£152.52

Sikaflex®-265

- Direct glazing and UV resistant joint sealant for buses, trucks and rail vehicles
- For use with mineral glass based windows
- 1-C formulation
- Fast curing
- Resistant to ageing and weathering
- Solvent and PVC free
- Equally suitable for manual application and bulk dispensing



Part No.	Description	Qty	Price
482295	300ml Black	1	£16.26
482297	600cc Black	20	£390.00

Sikaflex®-521UV

- Excellent adherent, weather resistant sealant
- Bonds well to a wide variety of substrates: timber, metals, metal primers, paint coatings (2-C systems), ceramic materials and plastics
- Elastic
- Can be sanded and painted over
- Non-corrosive
- High electrical resistance
- Isocyanate and solvent free



Part No.	Description	Qty	Price
482530	300ml Black	1	£12.13
482532	300ml Grey	12	£125.19
482534	300ml White	1	£12.13

Sikaflex®-552

- 1-C silane terminated polymer assembly adhesive with reduced substrate preparation
- Bonds well to a wide variety of substrates with practically no need for priming
- Ageing and weather resistant
- Capable of withstanding high dynamic stresses
- Can be painted over
- Non-corrosive
- High electrical resistance
- Silicone and PVC free



Part No.	Description	Qty	Price
482376	300ml Black	1	£16.69
482380	300ml White	12	£240.28
482384	600cc Black	12	£221.49

Sikaflex®-555

- Designed for use in the factory glazing of new cars (OEM specification) and in auto motive glass replacement
- Primerless Isocyanate free windshield adhesive
- No pre-heating required
- Easy to apply
- Solvent-free
- Isocyanate-free
- 300ml Black



£23.26

Part No. 482004

SikaLastomer®-710

- Especially suitable for plastic sealing with a possibility of future disassembly
- It can be used in the car, bus, truck and caravan industry.
- Good adhesion on almost every technical surface with minimal surface pretreatment
- 300ml Black



£5.69

Part No. 482292

SikaTack®MOVE Transportation



- Cold-applied 1-component polyurethane system
- Black primerless
- Excellent weather and cleaning agent resistance
- Provides good UV-resistance
- Excellent application and non-sag properties
- Optimal open time for large or heavy windcreens
- Prevents contact corrosion in aluminium-bodied vehicles
- Solvent-free
- Shortest Safe Drive-Away Times
- 600cc Black

£19.13

Part No. 482555

Additives

Preventative and problem-solving solutions

The additives focus on specific problems that arise in modern vehicles and help fight common driveability concerns including less power and high consumption of fuel and oil



Part No.	Description	Qty	Price
1	B408512 150ml Petrol Additive Standard	1	£9.76
2	B408510 150ml Petrol Additive PREMIUM	1	£13.21
3	B408515 150ml Diesel Additive Standard	1	£9.76
4	B408511 150ml Diesel Additive PREMIUM	1	£13.21
5	B408513 150ml DPF Additive	1	£4.60

400ml Brake Service Spray

- Prevents squeaky and screaming brakes
- Extremely resistant to pressure and very high temperatures
- Strongly adhering special ceramic/aluminium lubricant
- Protects against corrosion, oxidation and reduces wear
- Temperature resistance: -30°C to 1500°C



£6.52

Part No. B209235

500ml Brown Cavity Seal

- Protects hollow spaces (doors, box beams, etc.) against corrosion from the inside
- Expels moisture, penetrates rust and prevents further rusting
- Good creeping properties
- Drying time approximately 1 hour



£9.90

Part No. B372319

450ml Engine Flush

- Helps neutralise harmful engine acids, unstick internal engine components and prevent contamination of new oil by removing contaminants



£5.89

Part No. 610246

General Maintenance



Part No.	Description	Qty	Price
1	B409833 400ml DPF Cleaner (nozzle sold separately)	1	£14.51
2	B409832 300ml Radiator Leak Stop	1	£6.60
3	B408500 400ml Fuel Injection Cleaner	1	£5.02
4	B409810 500ml Spark Plug Injector Loosener	1	£8.36

Part No.	Description	Qty	Price
5	B148382 400ml Leak Detector	1	£5.59
6	B408459 400ml Dry Slide Service Spray PTFE	1	£9.20
7	B409834 400ml Gasket Remover	1	£7.92

K-Seal Coolant Leak Repair



- Can be used to seal holes and cracks in the head gasket, radiator, heater core, freeze plugs, water pump casing and other metal components of the cooling system in both petrol and diesel engines

Part No.	Description	Qty	Price
652216	236ml K-Seal	1	£11.74
652217	472ml Heavy Duty K-Seal	1	£22.96

400ml Waxoyl Aerosol Clear

- Thick, waxy fluid saturated with very powerful rustkiller
- Killing off old rust and preventing new rust, protecting your car by simply spraying it on to metal
- Solution will instantly chase out moisture and form a flexible, weatherproof skin that doesn't crack, dry out or wash off in the rain



£13.93

Part No. 976080

200ml Granville High Temperature Red Instant Gasket

- Compatible with catalytic converters
- Extra high temperature up to 650°F (343°C) intermittent

£19.41

Part No. 482240

2K 115g Metal Moulding Compound



- For the quick repair of metal, aluminium, hard plastic and many other materials
- Easy to use: knead, apply and then smooth out
- Machinable (drilling, grinding and sawing) after 20 minutes
- Paintable
- Temperature resistance: -50 to +180°C
- Processing time: 3-4 minutes
- Shore hardness: Shore D is 87
- Tensile strength: 4.5 N/mm2

£16.27

Part No. B338987

Blue Hylomar Jointing Compound

- The product can be used to replace a traditional gasket or to "dress" it to significantly improve the performance of the gasket
- Non-hardening
- Wide operating temperature range (-50 to +250°C)

Part No.	Description	Qty	Price
652251	100g	1	£5.53
652250	100g	6	£32.47

65ml 518 Gasket Eliminator

- For use on casted iron, steel and aluminium flanges
- Typical applications include sealing close-fitting joints between rigid metal faces and flanges
- Cures through minor surface contamination
- NSF P1 Reg. No. 123758

£34.74

Part No. 482570

50ml D444 Multi Gasket



- High viscosity anaerobic gasket sealant of low/medium strength which is designed to seal between rigid metal flanged connections
- An immediate low pressure seal is achieved once the fitting has been assembled
- The product offers good tolerance to oil, water and chemicals once fully cured

£11.62

Part No. 750732

500g SAS Exhaust Assembly Paste

- Eases exhaust assembly and seals all joints
- Silicone free
- Pack of 6

£20.54

Part No. VANSAS210/6

100ml Wellseal Jointing Compound



- Non-flammable
- Easy partability
- Non-hardening

£12.93

Part No. 488218

Exhaust Clamps



Part No.	Description	Qty	Price
VANEX118	1 1/8 (29mm)	20	£21.00
VANEX114	1 1/4 (32mm)	20	£10.17
VANEX138	1 3/8 (35mm)	20	£15.18
VANEX216	2 1/16 (52mm)	20	£11.93
VANEX214	2 1/4 (57mm)	20	£15.89
VANEX258	2 5/8 (67mm)	20	£18.87
VANEX3	3 (76mm)	20	£19.84
VANEX318	3 1/8 (80mm)	10	£14.64
VANEX314	3 1/4 (83mm)	10	£12.81
VANEX312	3 1/2 (89mm)	10	£10.59
VANEX358	3 5/8 (92mm)	10	£16.37
VANEX334	3 3/4 (95mm)	10	£11.93
VANEX4	4 (102mm)	10	£13.67
VANEX436	4 3/16 (106mm)	10	£14.54
VANEX414	4 1/4 (108mm)	10	£18.49
VANEX456	4 5/16 (110mm)	10	£17.14
VANEX412	4 1/2 (115mm)	10	£18.00
VANEX434	4 3/4 (120mm)	10	£18.00
VANEX5	5 (127mm)	10	£18.98
VANEX518	5 1/8 (130mm)	10	£18.49

Fully Plated Exhaust Clamps



Part No.	Description	Qty	Price
570207	1 1/8 (28mm)	10	£6.85
570208	1 3/8 (35mm)	10	£7.12
570210	1 1/2 (38mm)	20	£11.45
570214	1 5/8 (42mm)	20	£20.03
570218	1 11/16 (43mm)	20	£20.01
570222	1 3/4 (45mm)	20	£13.08
570226	1 7/8 (48mm)	20	£21.31
570230	2 (52mm)	20	£13.26
570234	2 1/8 (54mm)	20	£14.98
570238	2 1/4 (58mm)	10	£9.86
570250	2 3/8 (60mm)	20	£15.84
570242	2 1/2 (65mm)	20	£17.16
570254	2 5/8 (67mm)	20	£22.02
570258	2 3/4 (70mm)	20	£19.35
570204	3 (76mm)	1	£3.41
570262	3 1/8 (80mm)	10	£16.92
570266	3 5/8 (92mm)	10	£20.35

Exhaust Jointing Putty



- Formulated to fill small holes and cracks in exhaust systems thus delaying the need for replacement

Part No.	Description	Qty	Price
488205	140g Tube	6	£15.46
488209	250g Tub	1	£2.93
488210	250g Tub	6	£17.23

150g Firegum Exhaust Assembly Paste



- Fast & easy to use
- Creates a gas tight seal
- Resists heat and vibration

£7.57

Part No. 488215

Hydraulic Platform Truck 150kg

- Heavy-duty construction
- Fitted with four composite wheels, two fixed and two locking castor, for easy rolling over rough workshop and warehouse floors
- One-piece hydraulic unit controlled by large rear mounted foot pedal
- Safety release mechanism positioned on handlebar for smooth controlled descent and safety bars to prevent inadvertent lowering
- Suitable for numerous garage, industrial and warehouse applications
- Supplied with non-slip platform cover for added load security
- May also be used as a mobile service bench



£369.95

Part No. 810595



14 x 22 x 2mm Sump Plug Washers Aluminium

Suits Rover (All Honda engines), Honda (new models)

Qty: 50

£3.79

Part No. 543300



16 x 22 x 2mm Copper Sump Plug Compression Washers

Suits Citroen (<9/93), Peugeot (<9/93), Renault 5, Fiat (Diesel), Rover (Diesel)

Qty: 50

£9.84

Part No. 543302



12 x 17 x 2mm Copper Sump Plug Compression Washers

Suits Toyota Auris, Avensis, Camry, Carina, Celica, Corolla, Corona, Hiace, Hilux, Land Cruiser, Prius, Rav 4, Starlet, Supra, Yaris

Qty: 50

£17.11

Part No. 543304



16.7 x 24mm Sump Plug Bonded Seal Washers

Suits Ford Mondeo (Zetec engines), Ford Focus & Ka

Qty: 50

£20.20

Part No. 543306



22 x 27 x 1.5mm Sump Plug Aluminium Washers

Suits Fiat (except Diesel), Mercedes (some)

Qty: 50

£3.10

Part No. 543308



10 x 20 x 2mm Sump Plug Flat Copper Washers

Suits Citroen Berlingo, C1, C2, C3, C4, C5, C6, Xantia, Xsara, Fiat Scudo, Mini R56, R55, Clubman, Peugeot 107, 206, 207, 306, 307, 308, 406, 407, 607, 806, 807, 1007, 4007, Bipper, Expert, Partner, Toyota Aygo, Corolla, Volvo C30, S40 II, V50

Qty: 50

£13.04

Part No. 543310



14 x 20 x 2mm Copper Sump Plug Compression Washers

Suits Citroen (9/93>), Peugeot (9/93>)

Qty: 50

£13.91

Part No. 543314



13 x 22 x 3mm Flanged Sump Plug Rubber O-Rings

Suits Chrysler 300, Caravan, Cirrus, Crossfire, Le Baron, Neo, PT Cruiser, Sebring, Stratus, Voyager, Ford C-Max, Cougar, Courier, Escort, Fiesta, Focus, C-Max Focus, Fusion, Galaxy, Ka, Maverick, Mondeo, Puma, S-Max, Transit

Qty: 50

£5.16

Part No. 543316



12 x 24 x 2mm Fibre Sump Plug Washers

Suits Toyota Auris, Avensis, Camry, Carina, Celica, Corolla, Corona, Hiace, Hilux, Land Cruiser, Prius, Rav 4, Starlet, Supra, Yaris

Qty: 50

£4.99

Part No. 543318



18 x 2 NBR Nitrile Sump Plug Rubber O-Rings

Suits Vauxhall Astra F G H, Combo, Corsa B C D, Vectra B C

Qty: 50

£4.83

Part No. 543320



11 x 21 x 2.5mm Flanged Sump Plug Rubber O-Rings

Suits Vauxhall Astra G, Omega B, Signum, Vectra B C, Zafira

Qty: 50

£16.90

Part No. 543324



M14 x 1.5 x 17.5mm Sump Plugs with Captive Washer

Audi/VW type

Qty: 5

£9.72

Part No. 543312



M14 x 1.25 x 13mm Citroen/Peugeot Sump Plugs

Citroen/Peugeot type

Qty: 5

£6.92

Part No. 543326



M14 x 1.5 x 21mm Chrysler/Ford Sump Plugs

Chrysler/Ford type

Qty: 5

£14.08

Part No. 543326



Plastic Sump Plug - VW Type c/w Rubber O-Ring

VW Type

Qty: 1

£5.78

Part No. 543328



Plastic Sump Plug - FORD Connect Type c/w Rubber O-Ring

Ford Connect type

Qty: 1

£4.90

Part No. 543330

Sump Plug Removal/ Assembly Tool - VAG



Qty: 1

£13.18

Part No. BT006574

Plastic Oil Plug Driver Set

Specially designed for modern plastic drain plugs



Qty: 1

£19.79

Part No. BT006928



Plastic Sump Plug Removal Tool PSA/Ford

Fits OEM sump plugs, Ford 1871598 and PSA 9801444780

Qty: 1

£12.24

Part No. BT007088

250pc Zinc HT BZP Setscrews GR8.8 DIN933



£67.98
Part No. 750801

Assortment Contents		Top Ups		
Description	Qty	Part No.	Qty	Price
M6 x 25mm	40	247236	100	£5.36
M6 x 50mm	40	247244	100	£7.43
M8 x 25mm	40	247258	100	£6.86
M8 x 50mm	30	247268	100	£10.29
M10 x 25mm	30	247284	100	£10.44
M10 x 50mm	30	245372	100	£16.51
M12 x 25mm	20	245380	100	£15.83
M12 x 50mm	20	247322	50	£14.58

1600pc Black Self Tapping Screws



£76.64
Part No. 168910

Assortment Contents		Top Ups		
Description	Qty	Part No.	Qty	Price
3.5 x 16mm	200	173380-100	100	£3.18
3.9 x 19mm	200	173452-100	100	£4.15
4.2 x 16mm	200	173525-100	100	£3.21
4.2 x 19mm	200	173533-100	100	£3.51
4.2 x 22mm	150	173541-100	100	£4.52
4.8 x 13mm	150	173550-100	100	£3.04
4.8 x 16mm	150	173576-100	100	£3.34
4.8 x 19mm	150	173614-100	100	£3.43
4.8 x 22mm	100	173622-100	100	£4.24
4.8 x 25mm	100	632562-100	100	£4.62

900pc Phillips Black Flange Self Drilling Screws

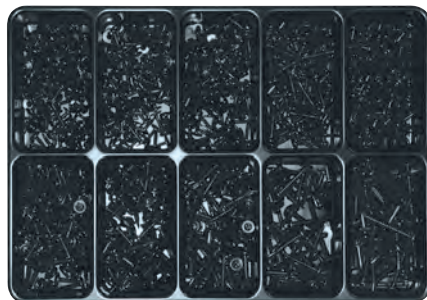

£66.72
Part No. 168922

Assortment Contents		Top Ups		
Description	Qty	Part No.	Qty	Price
3.9 x 13mm	100	158271-500	500	£8.59
3.9 x 16mm	100	158272-500	500	£11.24
3.9 x 19mm	100	158273-500	500	£12.07
3.9 x 25mm	100	158274-500	500	£15.33
4.8 x 16mm	100	832820-500	500	£15.62
4.8 x 19mm	100	832839-500	500	£16.95
4.8 x 22mm	100	832847-500	500	£18.79
4.8 x 25mm	100	832855-500	500	£20.85
4.8 x 32mm	50	158276-500	500	£27.15
4.8 x 45mm	50	158277-500	500	£30.81

THREAD & BEARING LOCK



We stock a wide range of sealants and adhesives, and accessories. This includes silicone sealants, adhesives for repairs and general use and applicator guns for accurate placement.

SEE PAGE 36-39 FOR OUR FULL RANGE OF SEALANTS & ADHESIVES

600pc Socket Head Cap Screws A2 Stainless Steel



£95.94
Part No. B175541

Assortment Contents		Top Ups		
Description	Qty	Part No.	Qty	Price
M4 x 10mm	25	B354767-200	200	£6.29
M4 x 16mm	25	B354783-200	200	£7.27
M4 x 25mm	25	B354805-200	200	£9.60
M5 x 10mm	50	B354821-100	100	£5.16
M5 x 16mm	50	B354848-100	100	£5.60
M5 x 20mm	50	B354856-100	100	£6.48
M5 x 25mm	25	B354864-100	100	£7.70
M5 x 30mm	25	B354872-100	100	£8.72
M5 x 40mm	25	B354899-100	100	£9.60
M6 x 12mm	50	B354902-100	100	£9.82
M6 x 16mm	50	B354910-100	100	£11.24
M6 x 20mm	50	B109649-100	100	£11.34
M6 x 25mm	25	B109657-100	100	£11.41
M6 x 30mm	25	B109665-100	100	£11.52
M6 x 35mm	25	B354929-100	100	£13.64
M8 x 16mm	25	B354970-100	100	£13.61
M8 x 25mm	25	B354996-100	100	£16.54
M8 x 30mm	25	B109720-100	100	£19.60

985pc Zinc Socket Head Cap Screws



£93.46
Part No. B341835

Assortment Contents		Top Ups		
Description	Qty	Part No.	Qty	Price
M4 x 10mm	100	B099988-200	200	£8.67
M4 x 16mm	100	B100005-200	200	£8.39
M4 x 20mm	100	B100021-200	200	£9.33
M5 x 10mm	100	B100129-100	100	£3.61
M5 x 16mm	100	B100145-100	100	£4.85
M5 x 20mm	100	B100161-100	100	£5.87
M5 x 30mm	50	B100196-100	100	£6.35
M6 x 10mm	50	B100293-100	100	£5.60
M6 x 16mm	50	B100315-100	100	£5.89
M6 x 20mm	50	B100331-100	100	£6.84
M6 x 30mm	30	B100366-100	100	£7.17
M6 x 35mm	30	B100374-100	100	£7.57
M8 x 16mm	25	B100536-100	100	£9.59
M8 x 20mm	25	B100552-100	100	£9.82
M8 x 25mm	25	B100579-100	100	£10.46
M8 x 30mm	25	B100587-100	100	£14.34
M8 x 40mm	15	B100609-100	100	£18.45
M10 x 30mm	10	B100803-100	100	£22.08

BUY 3 OR 5 ASSORTMENTS AND RECEIVE A 3 OR 5 DRAWER CABINET FREE

- Lockable
- Stackable
- Can be wall mounted

3 Drawer

Part No. 159331
Worth £106.05

5 Drawer

Part No. 159332
Worth £125.64



FREE

765pc Zinc Socket Countersunk Screws Assortment



£95.89

Part No. B003173

Assortment Contents		Top Ups		
Description	Qty	Part No.	Qty	Price
M5 x 10mm	100	B101958-100	100	£6.52
M5 x 12mm	100	B101966-100	100	£6.56
M5 x 20mm	100	B101982-100	100	£7.17
M5 x 30mm	50	B102008-100	100	£8.58
M6 x 10mm	50	B102016-100	100	£7.59
M6 x 16mm	50	B102032-100	100	£9.09
M6 x 20mm	50	B102040-100	100	£9.22
M6 x 25mm	40	B102059-100	100	£9.35
M6 x 30mm	40	B102067-100	100	£9.59
M8 x 16mm	30	B102113-100	100	£10.04
M8 x 20mm	40	B102121-100	100	£10.90
M8 x 25mm	25	B102130-100	100	£12.85
M8 x 30mm	20	B102148-100	100	£14.49
M8 x 40mm	20	B102164-100	100	£17.62
M8 x 50mm	15	B102172-50	50	£8.37
M10 x 30mm	15	B102210-100	100	£22.99
M10 x 40mm	10	B102237-50	50	£15.27
M12 x 40mm	10	B102296-50	50	£22.32

3790pc Metric Slotted Pan Machine Screws, Nuts &



£93.59

Part No. B169018

Assortment Contents		Top Ups		
Description	Qty	Part No.	Qty	Price
M3 x 16mm Machine Screw	100	B072273-200	200	£4.40
M3 x 20mm Machine Screw	100	B072281-200	200	£3.26
M4 x 6mm Machine Screw	200	B072397-200	200	£3.38
M4 x 10mm Machine Screw	200	B072419-200	200	£3.52
M4 x 16mm Machine Screw	200	B072435-200	200	£3.85
M4 x 20mm Machine Screw	100	B072451-200	200	£4.20
M4 x 25mm Machine Screw	100	B072460-200	200	£5.06
M4 x 40mm Machine Screw	50	B072494-200	200	£7.57
M5 x 20mm Machine Screw	100	B072613-200	200	£7.05
M5 x 30mm Machine Screw	50	B072648-200	200	£7.90
M5 x 35mm Machine Screw	50	B072656-200	200	£8.67
M5 x 40mm Machine Screw	40	B072664-200	200	£10.10
M3 Hex Nut DIN934 Gr8 BZP	500	B004324-250	250	£3.32
M4 Hex Nut DIN934 Gr8 BZP	500	B004332-100	100	£1.51
M5 Hex Nut DIN934 Gr8 BZP	250	B004340-100	100	£1.99
M3 Flat Washer DIN125A BZP	500	B007412-250	250	£1.77
M4 Flat Washer DIN125A BZP	500	B007420-250	250	£1.80
M5 Flat Washer DIN125A BZP	250	B007439-250	250	£1.94

1600pc DIN7981 Pan Self Tapping Screws



£70.09

Part No. 168909

Assortment Contents		Top Ups		
Description	Qty	Part No.	Qty	Price
3.5 x 9.5mm PH1	100	87769-250	250	£3.38
3.5 x 13mm Zinc Pozi	100	87777-250	250	£3.38
3.5 x 16mm PH1	100	87785-250	250	£4.63
3.5 x 19mm Zinc Pozi	100	87793-250	250	£4.21
4.2 x 9.5mm PH2	100	87920-250	250	£3.89
4.2 x 13mm Zinc Pozi	100	87939-250	250	£5.18
4.2 x 16mm PH2	100	87947-250	250	£4.58
4.2 x 19mm Zinc Pozi	100	87955-250	250	£5.32
4.2 x 22mm PH2	100	87963-250	250	£5.59
4.8 x 13mm Zinc Pozi	100	88021-250	250	£8.60
4.8 x 16mm PH2	100	88030-250	250	£5.83
4.8 x 19mm Zinc Pozi	100	88048-250	250	£6.35
4.8 x 22mm PH2	100	88056-100	100	£3.27
4.8 x 25mm Zinc Pozi	100	88064-100	100	£3.43
5.5 x 16mm PH3	50	88129-100	100	£3.93
5.5 x 19mm Zinc Pozi	50	88137-100	100	£4.13
5.5 x 22mm PH3	50	88145-100	100	£4.90
5.5 x 25mm Zinc Pozi	50	88153-100	100	£5.41

660pc M6-M12 DIN934 Hex and DIN982 Nyloc Nuts BZP



£83.14

Part No. 750798

Assortment Contents		Top Ups		
Description	Qty	Part No.	Qty	Price
M6 Hex Nuts Din934 Gr8	100	245438	200	£2.93
M8 Hex Nuts Din934 Gr8	100	245442	200	£5.36
M10 Hex Nuts Din934 Gr8	60	245446	200	£8.28
M12 Hex Nuts Din934 Gr8	40	245450	200	£13.74
M6 Coarse Nyloc Nuts P Type	100	232218	100	£2.62
M8 Coarse Nyloc Nuts P Type	100	232226	100	£4.17
M10 Coarse Nyloc Nuts P Type	100	232234	100	£7.98
M12 Coarse Nyloc Nuts P Type	60	232242	100	£9.87

351pc Galvanised Steel Splined Nutserts & Tool



£112.17

Part No. B168918

Assortment Contents		Top Ups		
Description	Qty	Part No.	Qty	Price
M4 x 10mm Nutserts	25	B143711-100	100	£9.30
M4 x 12.5mm Nutserts	25	B120003-100	100	£10.91
M5 x 11.5mm Nutserts	25	B143713-100	100	£11.08
M5 x 13.5mm Nutserts	25	B120004-100	100	£11.25
M6 x 14mm Nutserts	25	B143714-100	100	£11.77
M6 x 15.5mm Nutserts	25	B120005-100	100	£12.42
M6 x 18.5mm Nutserts	25	B119937-100	100	£13.12
M4 x 11mm Large Flange Nutserts	50	B119923-100	100	£11.24
M5 x 13mm Large Flange Nutserts	50	B119925-100	100	£11.70
M5 x 16mm Large Flange Nutserts	50	B119926-100	100	£12.05
M6 x 16mm Large Flange Nutserts	25	B119933-100	100	£17.85
Blind Rivet Nut Pliers	1	B124609	1	£43.02

8pc T-Handle Metric Hex Key Set (2-10mm)



CUSTOMERS ALSO BOUGHT

£53.08

Part No. B240255

- Contents: 2, 2.5, 3, 4, 5, 6, 8 & 10mm
- Supplied in foam insert

7pc PH/SL Screwdriver Set



CUSTOMERS ALSO BOUGHT

£44.66

Part No. B240287

Set contains x1 of the following:

- PH1 x 80mm
- PH2 x 100mm
- PH3 x 150mm
- ZS 3.5 X 100mm
- ZS 5.5 X 100mm
- ZS 6.5 X 100mm
- ZS 8.0 X 100mm

8pc H/D PH/SL/PZ Screwdriver Set With Striking Cap

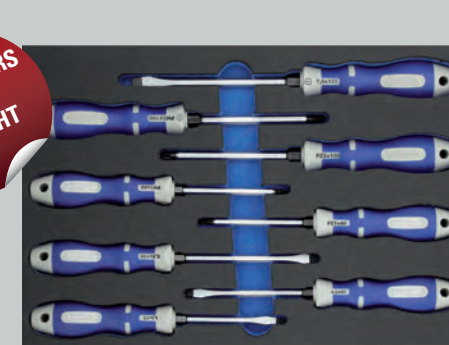

CUSTOMERS ALSO BOUGHT

£50.41

Part No. B240282

Set contains x1 of the following:

- PH1 x 80mm
- PH2 x 100mm
- PZ1 x 80mm
- PZ2 x 100mm
- SL 3.5 x 75mm
- SL 4.5 x 90mm
- SL 5.5 x 100mm
- SL 7.0 x 125mm

1850pc 1.0-6.3mm DIN94 Metric Split Pins



£89.94
Part No. 168926

Assortment Contents		Top Ups		
Description	Qty	Part No.	Qty	Price
1 x 20mm	250	2003-250	250	£3.03
1.6 x 32mm	250	2020-250	250	£3.07
2 x 32mm	250	2054-250	250	£4.94
2.5 x 32mm	250	2070-250	250	£6.55
2.5 x 40mm	250	2089-100	100	£3.58
3.2 x 32mm	100	2097-100	100	£4.13
3.2 x 50mm	100	2119-100	100	£4.43
3.5 x 40mm	100	2135-100	100	£5.37
4 x 40mm	100	2151-100	100	£5.68
4 x 63mm	100	2178-100	100	£7.44
5.0 x 50mm	50	2186-50	50	£6.88
6.3 x 63mm	50	2208-50	50	£7.00

670pc Cotter Pins DIN1481



£90.26
Part No. 168933

Assortment Contents		Top Ups		
Description	Qty	Part No.	Qty	Price
3 x 30mm	50	51-100	100	£6.78
3 x 40mm	50	78-100	100	£7.82
4 x 20mm	50	108-100	100	£8.28
4 x 30mm	50	132-100	100	£8.58
4 x 40mm	50	159-100	100	£8.74
4 x 50mm	50	167-100	100	£10.86
5 x 30mm	50	213-100	100	£13.24
5 x 40mm	50	248-100	100	£13.42
5 x 50mm	25	264-100	100	£13.97
6 x 30mm	50	310-100	100	£14.55
6 x 40mm	50	337-50	50	£7.33
6 x 50mm	25	353-50	50	£8.02
6 x 60mm	25	361-50	50	£8.18
8 x 40mm	25	400-50	50	£9.83
8 x 50mm	25		N/A	
8 x 60mm	25	434-25	25	£6.94
10 x 50mm	10	485-10	10	£3.82
10 x 60mm	10	507-25	25	£10.64

975pc 8 - 35mm External Circlips BS3030 DIN471



£123.87
Part No. B168932

Assortment Contents		Top Ups		
Description	Qty	Part No.	Qty	Price
M8 x 7.4 x 0.8mm	100	B006793-100	100	£3.16
M10 x 9.3 x 1mm	100	B006815-100	100	£3.12
M12 x 11 x 1mm	100	B006823-100	100	£3.28
M14 x 12.9 x 1mm	100	B006831-100	100	£3.83
M15 x 13.8 x 1mm	100	B006840-100	100	£3.94
M16 x 14.7 x 1mm	100	B006858-100	100	£4.52
M17 x 15.7 x 1mm	50	B006866-50	50	£5.13
M18 x 16.5 x 1.2mm	50	B006874-50	50	£5.61
M20 x 18.5 x 1.2mm	50	B006882-50	50	£6.14
M22 x 20.5 x 1.2mm	25	B006890-25	25	£4.68
M24 x 22.2 x 1.2mm	25	B006904-25	25	£4.54
M25 x 23.2 x 1.2mm	25	B006912-25	25	£5.01
M26 x 24.2 x 1.2mm	25	B006920-25	25	£3.76
M28 x 25.9 x 1.5mm	25	B006939-25	25	£6.44
M30 x 27.9 x 1.5mm	25	B006947-25	25	£6.71
M32 x 29.6 x 1.5mm	25	B006963-25	25	£7.40
M35 x 32.2 x 1.5mm	25	B006955-25	25	£8.64
M40 x 36.5 x 1.75mm	25	B006980-25	25	£11.80

650pc Internal Circlips



£85.57
Part No. B235300

Assortment Contents		Top Ups		
Description	Qty	Part No.	Qty	Price
15 x 1.0mm	50	B007005-25	25	£3.03
16 x 1.0mm	50		N/A	
18 x 1.0mm	50		N/A	
20 x 1.0mm	50		N/A	
22 x 1.0mm	50	B007056-25	25	£0.83
23 x 1.0mm	50		N/A	
24 x 1.2mm	50	B007072-25	25	£1.16
25 x 1.2mm	50	B007080-25	25	£3.11
26 x 1.2mm	25		N/A	
28 x 1.2mm	25	B007102-25	25	£1.65
30 x 1.2mm	25	B007110-25	25	£1.93
32 x 1.2mm	25	B007129-25	25	£2.70
34 x 1.5mm	25	B007145-25	25	£4.95
35 x 1.5mm	25	B007153-25	25	£2.37
36 x 1.5mm	25	B007161-25	25	£2.42
37 x 1.5mm	25	B007170-25	25	£3.19
38 x 1.5mm	25	B007188-25	25	£2.88
40 x 1.75mm	25	B007196-10	10	£2.53

70pc Linch Pins and R-Clips

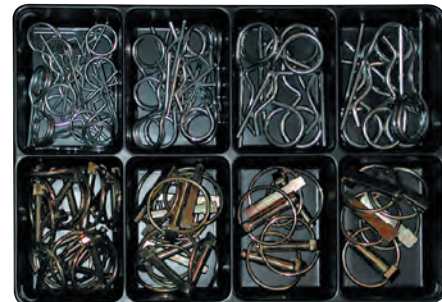

£75.78
Part No. B168916

Assortment Contents		Top Ups		
Description	Qty	Part No.	Qty	Price
M3 x 48mm R-clip	15	B523801-10	10	£5.09
M4 X 64mm R-clip	10	B523810-10	10	£5.65
M5 x 80mm R-clip	10	B523828-10	10	£7.50
M6 x 42mm Linch Pin	15	B002313-10	10	£5.20
M8 x 42mm Linch Pin	10	B002321-10	10	£6.53
M9 x 42mm Linch Pin	5		N/A	
M11 x 42mm Linch Pin	5	B002348-10	10	£8.90

6pc Punch Set

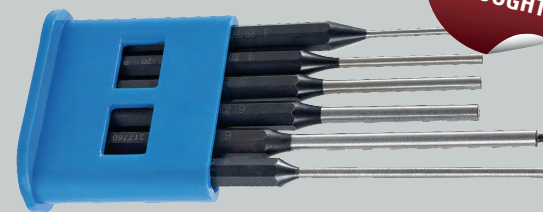

CUSTOMERS ALSO BOUGHT

Set contains x1 of the following:

- 150 x 3 x 10mm pin punch
- 150 x 4 x 10mm pin punch
- 175 x 4 x 10mm pin punch
- 150 x 5 x 10mm pin punch
- 175 x 4 x 10mm pin punch + pin
- 150 x 6 x 10mm pin punch

£26.31
Part No. B372286

19-60mm Circlip Pliers External 90° Curved Nose



CUSTOMERS ALSO BOUGHT

- The pliers are hot-forged from high-quality steel and then oil-hardened
- Precision-crafted hinge for smooth use
- Equipped with PTFE plastic coating and the handle is covered with PVC
- Suitable for circlips according to DIN 471
- Curved jaws (90°) with anti-slip tips
- According to DIN 5254 B.

£20.28
Part No. B001412

Circlip Pliers Internal Straight Nose



CUSTOMERS ALSO BOUGHT

Part No.	Description	Qty	Price
B001416	8-13mm	1	£15.99
B001417	12-25mm	1	£16.12
B001418	19-60mm	1	£17.41
B001420	40-100mm	1	£17.97
B001421	85-140mm	1	£26.41

325pc Speed Fasteners



£74.06
Part No. B169003

Assortment Contents		Top Ups		
Description	Qty	Part No.	Qty	Price
15 x 11 D3.9	50	B078875-100	100	£6.01
15 x 12 D4.8	25	B078921-100	100	£6.01
16 x 11 D3.5	50	B078840-100	100	£7.83
16 x 11 D4.2	50	B078883-100	100	£7.83
16.5 x 11 D3.5	50	B078832-100	100	£8.54
20 x 13 D5.6	25	B078948-100	100	£11.75
24 x 16 D4.8	25	B078913-100	100	£15.42
25 x 16 D6.5	50	B078964-100	100	£19.07

276pc Speed Fastener & Hex Head Parker Screws



£81.47
Part No. B169001

Assortment Contents		Top Ups		
Description	Qty	Part No.	Qty	Price
15 x 12 D4.8 Speed Fastener	25	B078921-100	100	£6.01
16 x 11 D4.2 Speed Fastener	25	B078883-100	100	£7.83
20 x 13 D5.6 Speed Fastener	25	B078948-100	100	£11.75
24 x 16 D4.8 Speed Fastener	25	B078913-100	100	£15.42
24.5 x 14.5 D6.5 Speed Fastener	25	B078972-100	100	£17.25
25 x 16 D6.5 Speed Fastener	25	B078964-100	100	£19.07
4.8 x 19mm Hex Head Parker Screw	25	B079995-100	100	£12.02
5.6 x 13mm Hex Head Parker Screw	1	B273600-100	100	£12.50
5.6 x 19mm Hex Head Parker Screw	25	B079952-100	100	£12.98
6.3 x 16mm Hex Head Parker Screw	25	B079413-100	100	£13.44
6.3 x 19mm Hex Head Parker Screw	25	B079405-100	100	£14.59
6.5 x 16mm Hex Head Parker Screw	25	B081604-100	100	£18.37

1335pc 6-32mm DIN7603 Metric Copper Sealing Rings



£120.98
Part No. 168927

Assortment Contents		Top Ups		
Description	Qty	Part No.	Qty	Price
M6 x 10 x 1mm	100	558-100	100	£4.48
M6 x 12 x 1mm	100	566-100	100	£4.92
M8 x 12 x 1mm	100	574-100	100	£5.02
M8 x 14 x 1mm	100	582-100	100	£5.46
M10 x 14 x 1mm	100	809-100	100	£6.38
M10 x 16 x 1mm	100	817-100	100	£7.00
M12 x 16 x 1.5mm	100	604-100	100	£7.78
M12 x 18 x 1.5mm	100	B000833-100	100	£9.85
M14 x 18 x 1.5mm	100	612-100	100	£9.92
M14 x 20 x 1.5mm	100	B000620-100	100	£11.04
M16 x 20 x 1.5mm	50	647-50	50	£5.13
M16 x 22 x 1.5mm	50	825-50	50	£6.64
M18 x 24 x 1.5mm	50	671-50	50	£9.27
M20 x 26 x 1.5mm	50	698-50	50	£9.41
M22 x 27 x 1.5mm	50	701-50	50	£6.93
M26 x 32 x 2mm	50	744-50	50	£15.90
M30 x 36 x 2mm	25	787-50	50	£20.91
M32 x 38 x 2mm	10	795-50	50	£21.00

280pc Sump Plug Washers



£72.24
Part No. B207906

Assortment Contents		Top Ups		
Description	Qty	Part No.	Qty	Price
M12 x 18 x 1.5mm DIN7603 Copper	20	B000833-100	100	£9.85
M14 x 20 x 1.5mm DIN7603 Copper	20	B000620-100	100	£11.04
M12 x 18 x 1.5mm DIN7603 Aluminium	20	B001252-100	100	£4.41
M14 x 19 x 2.2mm Galvanized Steel	20	B005490-100	100	£54.02
M13 x 24 x 1.5mm Galvanized Steel Rubber	20	B141696-50	50	£11.83
M18.5 x 26 x 2.5mm Galvanized Steel Rubber	20	B109806-50	50	£31.41
M13 x 22 x 3mm Rubber Sealing Rings	20	B165182-50	50	£3.11
M14 x 22 x 1.5mm DIN7603 Aluminium	20	B169921-100	100	£7.70
M12 x 17 x 3mm Copper	20	B171336-100	100	£18.77
M12 x 21 x 1.7mm Aluminium	20	B207773-50	50	£24.49
M14 x 20 x 2mm Tinned Steel	20	B207775-50	50	£33.03
M12 x 24 x 2mm Klinger-SIL	20	B835250-50	50	£8.55
M18 x 22 x 2mm Rubber O-Ring	20	B165181-50	50	£2.34
M10 x 21 x 1.5mm DIN7603 Copper	20	B171335-50	50	£5.70

1275pc 5-26mm DIN7603 Fibre Washers



£76.64
Part No. 168928

Assortment Contents		Top Ups		
Description	Qty	Part No.	Qty	Price
5 x 9 x 1mm	100	1422-100	100	£3.22
6 x 10 x 1mm	100	1449-100	100	£3.21
6 x 12 x 1mm	100	1457-100	100	£3.40
8 x 12 x 1mm	100	1473-100	100	£3.44
8 x 14 x 1mm	100	1643-100	100	£2.34
10 x 16 x 1mm	100	1490-100	100	£4.16
12 x 16 x 1.5mm	100	1503-100	100	£4.32
12 x 18 x 1.5mm	100	1511-100	100	£4.59
12 x 20 x 1.5mm	100	1520-100	100	£6.33
14 x 18 x 1.5mm	100	1538-100	100	£5.24
14 x 20 x 1.5mm	100	1546-100	100	£5.61
16 x 22 x 1.5mm	50	1589-100	100	£6.52
18 x 22 x 1.5mm	50	1597-100	100	£4.36
22 x 27 x 1.5mm	50	1619-50	50	£4.14
26 x 32 x 2mm	25	1635-50	50	£4.96

**ALL ASSORTMENTS
COME IN A STURDY
METAL CASE AND
PLASTIC TRAY**

**SEE PAGES 85-89
FOR GREAT WORKSHOP STORAGE SOLUTIONS**

Empty Metal Assortment Box
Part No. B167665

130pc M6-M24 Dowty Washers



£82.76
Part No. 134797

Assortment Contents		Top Ups		
Description	Qty	Part No.	Qty	Price
M6	10	B765147-50	50	£6.56
M8	10	B778150-50	50	£7.10
M10	10	B778168-50	50	£7.32
M12	10	B106400-50	50	£7.57
M14	25	B106401-50	50	£8.23
M16	25	B936773-50	50	£8.59
M18	10	B106404-50	50	£10.79
M20	10	B106405-50	50	£12.00
M22	10	B778141-50	50	£15.61
M24	10	B778176-50	50	£15.68

1240pc Flat & Repair Washers



£84.70
Part No. 750797

Assortment Contents		Top Ups		
Description	Qty	Part No.	Qty	Price
M6 H-Flat Washer BS4320 Form A	300	473214	1000	£7.58
M8 H-Flat Washer BS4320 Form A	200	473218	500	£7.84
M10 H-Flat Washer BS4320 Form A	100	473222	500	£17.49
M12 H-Flat Washer BS4320 Form A	160	473226	400	£18.12
3/16 x 1" Repair Washers BZP	100	536254	200	£7.25
1/4 x 1" Repair Washer BZP	100	536255	200	£9.23
5/16 x 1 1/2" Repair Washers BZP	50	536258	200	£14.64
3/8 x 1" Repair Washer BZP	100	536253	200	£8.67
1/4 x 1 1/2" Repair Washers BZP	40	536256	200	£19.86
3/8 x 1 1/2" Repair Washer BZP Table 11	50	536226	100	£7.84
5/16 x 2" Repair Washer BZP Table 11	40	536219	200	£22.28

4990pc Metric Washer Assortment

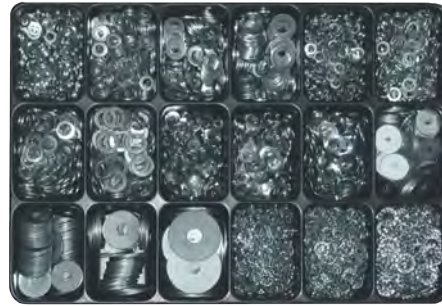

£120.69
Part No. 168917

Assortment Contents		Top Ups		
Description	Qty	Part No.	Qty	Price
M5 x 20 x 1.5mm Repair Washer	150	B008818-100	100	£3.01
M8 x 30 x 1.5mm Repair Washer	50	B008850-100	100	£3.58
M6 x 25 x 1.5mm Repair Washer	100	B008958-100	100	£3.84
M10 x 40 x 2mm Repair Washer	40	B008800-100	100	£14.97
M5 Shake proof Washer	500	B002828-100	100	£1.44
M6 Shake proof Washer	500	B002836-100	100	£1.54
M8 Shake proof Washer	300	B002852-100	100	£2.68
M6 Wave Washer	500	B003263-250	250	£2.96
M8 Wave Washer	300	B003280-250	250	£5.99
M10 Wave Washer	200	B003298-250	250	£12.92
M5 Spring Washer	500	B003638-100	100	£1.37
M6 Spring Washer	350	B003646-100	100	£1.75
M8 Spring Washer	200	B003662-100	100	£3.44
M10 Spring Washer	150	B003670-100	100	£3.61
M5 Washer BZP	500	B007439-100	100	£1.49
M6 Washer BZP	400	B007447-100	100	£1.57
M8 Washer BZP	150	B007463-100	100	£2.55
M10 Washer BZP	100	B007471-100	100	£2.65

330pc Metric O-Rings



£62.50
Part No. 54478

Assortment Contents		Top Ups		
Description	Qty	Part No.	Qty	Price
3.0 x 2.0mm	25	122051-50	50	£1.90
4.0 x 2.0mm	25	122052-50	50	£2.60
5.0 x 2.0mm	25	122053-50	50	£2.68
6.0 x 2.0mm	25	122054-50	50	£2.24
7.0 x 2.0mm	25	122055-50	50	£2.01
8.0 x 2.0mm	25	122056-50	50	£3.32
10.0 x 2.5mm	25	122057-50	50	£2.72
12.0 x 2.5mm	25	122058-50	50	£2.98
14.0 x 2.5mm	25	122059-50	50	£3.14
15.0 x 2.5mm	25	122060-50	50	£3.26
17.0 x 2.5mm	10	122061-25	25	£3.43
18.0 x 3.0mm	10	122063-25	25	£3.61
19.0 x 2.5mm	10	122062-25	25	£3.64
20.0 x 3.0mm	10	122064-25	25	£3.73
22.0 x 3.0mm	10	122065-25	25	£3.94
24.0 x 3.0mm	10	122066-25	25	£4.08
25.0 x 3.0mm	10	122067-25	25	£4.17
28.0 x 3.0mm	10	122069-25	25	£4.33

566pc Imperial O-Rings



£40.43
Part No. B235350

Assortment Contents		Top Ups		
Description	Qty	Part No.	Qty	Price
5/32 x 1.78mm	50	B001767-50	50	£4.18
3/16 x 1.78mm	50	B001775-50	50	£2.55
7/32 x 1.78mm	50	B001783-50	50	£3.06
1/4 x 1.78mm	50	B001791-50	50	£3.06
5/16 x 1.78mm	50	B001805-50	50	£3.12
3/8 x 1.78 mm	25	B001813-50	50	£3.74
3/8 x 2.62mm	50	B001821-50	50	£3.66
7/16 x 2.62mm	25	B001830-50	50	£3.21
1/2 x 2.62mm	25	B001848-50	50	£4.16
9/16 x 2.62mm	25	B001856-50	50	£4.35
5/8 x 2.62mm	25	B001864-50	50	£4.48
11/16 x 2.62mm	20	B001872-25	25	£3.03
3/4 x 2.62mm	10	B001880-25	25	£3.07
3/4 x 3.53mm	15	B001899-25	25	£3.58
13/16 x 3.53mm	10	B001902-25	25	£3.88
15/16 x 3.53mm	10	B001910-25	25	£4.00
1 x 3.53mm	10	B001929-25	25	£4.16
1 1/6 x 3.53mm	10	B001937-25	25	£3.83
1 1/8 x 3.53mm	10	B001945-25	25	£4.06
1 1/4 x 3.53mm	10	B001953-25	25	£4.39
1 3/8 x 3.53mm	10	B001961-10	10	£3.42
1 7/16 x 3.53mm	10	B001970-10	10	£3.16
1 1/2 x 5.34mm	8	B001988-10	10	£4.08
1 5/8 x 5.34mm	8	B001996-10	10	£4.08

View our extensive range of hand tools including screwdrivers, spanners, hammers, files, vices, measuring and VDE tools

SEE PAGES 90-137



425pc Metric/Imperial Grease Nipples

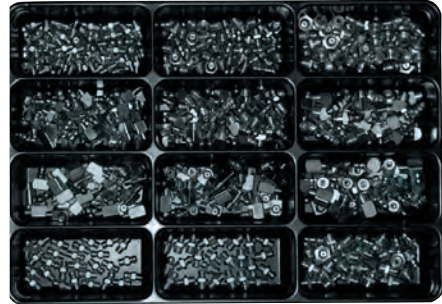

£180.03
Part No. 168974

Assortment Contents		Top Ups		
Description	Qty	Part No.	Qty	Price
M6 x 1mm H1 Straight	50	13617-25	25	£6.26
M8 x 1mm H1 Straight	50	13625-25	25	£7.44
M10 x 1mm H1 Straight	50	13633-25	25	£7.32
M6 x 1mm H2 45 Degree	50	13641-25	25	£13.06
M8 x 1mm H2 45 Degree	50	13650-25	25	£14.39
M10 x 1mm H2 45 Degree	25	13668-25	25	£13.26
M6 x 1mm H3 90 Degree	25	13684-25	25	£13.35
M8 x 1mm H3 90 Degree	25	13692-25	25	£13.84
M10 x 1mm H3 90 Degree	25	13706-25	25	£14.83
1/4 UNF H1 Straight	25	13722-25	25	£7.45
5/16 UNF H1 Straight	25	13730-25	25	£7.96
3/8 UNF H1 Straight	25	13749-25	25	£9.97

16pc 19-76mm Bi-Metal HSS Hole Saws

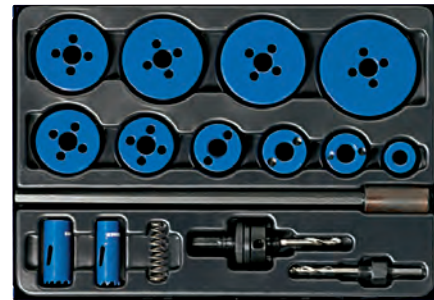

£127.56
Part No. B169006

Assortment Contents		Top Ups		
Description	Qty	Part No.	Qty	Price
19mm Hole Saw Bi-Metal HSS	1	B345318	1	£3.94
22mm Hole Saw Bi-Metal HSS	1	B345326	1	£4.30
25mm Hole Saw Bi-Metal HSS	1	B345334	1	£4.40
32mm Hole Saw Bi-Metal HSS	1	B345342	1	£5.29
35mm Hole Saw Bi-Metal HSS	1	B345350	1	£6.01
38mm Hole Saw Bi-Metal HSS	1	B345369	1	£6.08
44mm Hole Saw Bi-Metal HSS	1	B345377	1	£6.24
51mm Hole Saw Bi-Metal HSS	1	B345385	1	£8.31
57mm Hole Saw Bi-Metal HSS	1	B345393	1	£8.55
64mm Hole Saw Bi-Metal HSS	1	B345407	1	£8.75
67mm Hole Saw Bi-Metal HSS	1	B345415	1	£8.92
76mm Hole Saw Bi-Metal HSS	1	B345423	1	£10.48
A2 Arbor 32-152mm	1	B345431	1	£13.83
A4 Arbor 32mm	1	B468538	1	£10.88
300mm A2 Arbor Extension	1	B345458	1	£6.85
Compression Spring	1	B345466	1	£0.67

166pc (1-10.5mm) Bright Finish Silver HSS SP Drills

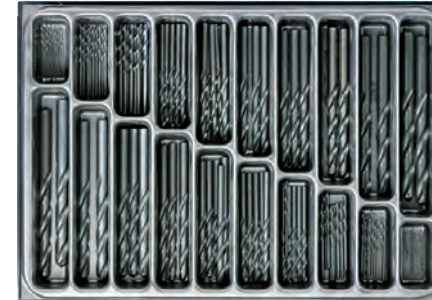

£168.43
Part No. B131347

Assortment Contents		Top Ups		
Description	Qty	Part No.	Qty	Price
1mm	10	700610	10	£4.13
1.5mm	10	700612	10	£4.53
2mm	10	700614	10	£4.93
2.5mm	10	700616	10	£5.06
3mm	10	700618	10	£5.62
3.5mm	10	700624	10	£6.34
4mm	10	700628	10	£7.27
4.5mm	10	700632	10	£8.32
5mm	10	700638	10	£9.17
5.5mm	10	700640	10	£12.64
6mm	10	700646	10	£14.03
6.5mm	10	700648	10	£16.73
7mm	10	700652	10	£19.20
7.5mm	10	700654	10	£21.67
8mm	5	700656	5	£14.23
8.5mm	5	700658	5	£15.90
9mm	5	700660	5	£17.69
9.5mm	5	700662	5	£18.28
10mm	5	700664	5	£20.98
10.5mm	1	700668	1	£5.72

119pc (1-10mm) STANDARDline 338 HSS RF Drills



£104.48
Part No. 169002

Assortment Contents		Top Ups		
Description	Qty	Part No.	Qty	Price
1mm	10	8321-10	10	£3.48
1.5mm	10	8322-10	10	£3.73
2mm	10	8323-10	10	£5.40
2.5mm	10	8324-10	10	£5.53
3mm	10	8325-10	10	£5.96
3.2mm	10	8326-10	10	£5.78
3.5mm	10	8327-10	10	£6.26
4mm	10	8328-10	10	£6.78
4.5mm	5	8330-10	10	£7.39
5mm	5	8332-10	10	£7.15
5.5mm	5	8333-10	10	£9.63
6mm	5	8334-10	10	£10.81
6.5mm	5	8336-10	10	£17.02
7mm	2	8337-10	10	£16.94
7.5mm	2	8339-10	10	£18.33
8mm	2	8340-5	5	£10.47
8.5mm	2	8341-5	5	£10.23
9mm	2	8342-5	5	£17.03
9.5mm	2	8343-5	5	£17.23
10mm	2	8344-5	5	£17.95

Grease Guns & Accessories

Part No.	Description	Qty	Price	
1	734259	500cc Professional Side Lever	1	£10.77
2	734261	500cc Heavy Duty Side Lever	1	£18.44
3	734916	500cc Pistol Grip	1	£27.62
4	734250	4 Jaw End Connectors	10	£20.76
5	734500	Quick Release Grease Coupler	1	£31.81
6	734502	Quick Release Grease Coupler Ultra Light	1	£23.75

400ml Drilling & Cutting Oil

- For drilling, thread cutting and turning
- Suitable for metal, light and heavy aluminium, copper, stainless steel and brass
- Reduces heat generation
- Extends the life of drilling and cutting tools



£5.92
Part No. B911371

18V Brushless Drill Driver

- Extreme power until the battery is empty
- More power with a heavy load
- 2-stage, brushless motor with torque of 135Nm
- Perfect for work in tight spaces
- Only 175mm long and only weighs 2.1kg
- New all-metal and keyless drill bit, with slip-free ratchet mechanism for changing drills or bits quickly
- Trigger button controls the speed to better match each application
- LED lamp illuminates the workplace in dark places
- B369783: supplied with 2x 5.0Ah Li-ion batteries and charger



Part No.	Description	Price
B369783	Tool with 2x 5.0Ah Li-ion Batteries	£465.55
B369784	Bare Tool	£220.53

CUSTOMERS ALSO BOUGHT

860pc Electrical Terminals

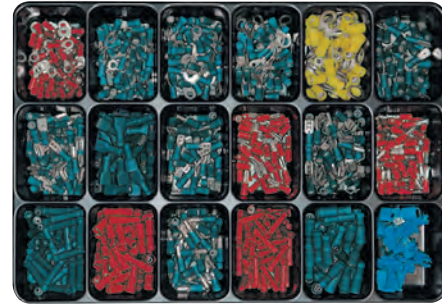

£78.03
Part No. 168912

Assortment Contents		Top Ups		
Description	Qty	Part No.	Qty	Price
0.5 - 1.0mm Red Butt Connectors	50	B012297-100	100	£7.47
1.0 - 2.5mm Blue Butt Connectors	50	B012270-100	100	£8.36
M4 Red Ring Terminals	50	B012505-100	100	£3.30
M4 Blue Ring Terminals	50	B012440-100	100	£10.38
M5 Blue Ring Terminals	50	B012432-100	100	£10.64
M6 Blue Ring Terminals	50	B012416-100	100	£11.19
M8 Yellow Ring Terminals	50	B012475-100	100	£21.25
4mm Red Male Bullet Terminals	50	B012386-100	100	£8.23
5mm Blue Male Bullet Terminals	50	B012394-100	100	£9.79
4mm Red Female Bullet Terminals	50	B012327-100	100	£9.79
5mm Blue Female Bullet Terminals	50	B012335-100	100	£10.64
2.8 x 0.5mm Red Male Spade Terminals	50	B012670-100	100	£8.48
6.3 x 0.8mm Blue Male Spade Terminals	50	B012254-100	100	£8.72
4.8 x 0.5mm Blue Female Spade Terminals	50	B012351-100	100	£9.02
6.3 x 0.8mm Blue Female Spade Terminals	50	B012610-100	100	£10.19
6.3 x 0.8 Blue Fully Insulated Spade Terminals	50	B012378-100	100	£11.42
6.3 x 0.8mm Blue Piggyback Terminals	50	B012300-100	100	£10.36
2.5mm Blue Quick Snap Lock Connector	10	B013153-100	100	£8.51

200pc Heat Shrink Terminals



£81.94
Part No. 168967

Assortment Contents		Top Ups		
Description	Qty	Part No.	Qty	Price
0.5-1.0mmSq Red Butt Connectors	25	336815-100	100	£32.41
1.5-2.5mmSq Blue Butt Connectors	25	336823-100	100	£35.71
5.3mm Red Ring Terminals	25	145297-100	100	£27.81
6.4mm Blue Ring Terminals	25	145572-100	100	£29.02
6.4mm Yellow Ring Terminals	25	145750-100	100	£40.34
8.4mm Blue Ring Terminals	25	538949-100	100	£28.44
6.35mm Blue Male Spade Connectors	25	538990-100	100	£22.72
6.35mm Blue Female Spade Connectors	25	538930-100	100	£47.93

130pc 2.4-25.4mm Heat Shrink Lengths



£54.07
Part No. 168969

Assortment Contents		Top Ups		
Description	Qty	Part No.	Qty	Price
2.4 x 100mm	20	318248-50	50	£2.11
3.2 x 100mm	20	318256-50	50	£3.00
4.8 x 100mm	20	B411553	50	£3.33
6.4 x 100mm	20	B411554	50	£4.40
9.6 x 100mm	20	318280-25	25	£2.33
12.7 x 100mm	10	B411556-10	10	£1.20
19.1 x 100mm	10	318302-10	10	£1.77
25.4 x 100mm	10	B411558-10	10	£2.32

Blue Fire Blow Torch and Gas



CUSTOMERS ALSO BOUGHT

• Mini gas burner soldering torch effective for minor heating and shrink applications e.g. for heatshrink and solder connectors

Part No.	Description	Price
B413516	Blue Fire Blow Torch	£10.56
B414186	200ml Gas Refill	£4.09
111454	Blue Fire Blow Torch & 200ml Gas Refill	£13.65

560pc Superseal Connectors



£130.06
Part No. B169438

Assortment Contents		Top Ups		
Description	Qty	Part No.	Qty	Price
1.5mm 2-way Female	10	B166676	1	£2.80
1.5mm 2-way Male	10	B166671	1	£2.83
1.5mm 3-way Female	10	B166677	1	£2.93
1.5mm 3-way Male	10	B166672	1	£3.30
1.5mm 4-way Female	10	B166678	1	£3.79
1.5mm 4-way Male	10	B166673	1	£4.13
Seal - Green	100	B166669-100	100	£9.34
Seal - Yellow	100	B166670-100	100	£8.65
Seal - Red	100	B166668-100	100	£13.22
1 - 1.50mm Female Pins	100	B166681-100	100	£38.42
1 - 1.50mm Male Pins	100	B166682-100	100	£38.42

30pc Superseal Pre-wired Connectors



£85.95
Part No. B249067

Assortment Contents		Top Ups		
Description	Qty	Part No.	Qty	Price
1.5mm 2-way Female	5	B021029	1	£3.55
1.5mm 2-way Male	5	B021051	1	£3.71
1.5mm 3-way Female	5	B021030	1	£4.03
1.5mm 3-way Male	5	B021052	1	£4.11
1.5mm 4-way Female	5	B021031	1	£4.87
1.5mm 4-way Male	5	B021053	1	£5.01

240pc Wiring Grommets



£64.14
Part No. B168973

Assortment Contents		Top Ups		
Description	Qty	Part No.	Qty	Price
4.5D 6634 Double	50	B414134-25	25	£3.97
6.0D 6646 Double	50	B414135-25	25	£6.32
9.0D 6648 Double	50	B414136-25	25	£1.90
10.0D 6650 Double	25	B414138-25	25	£2.87
12.0D 6652 Double	25	B013331-25	25	£6.00
13.0D 6662 Double	10	B414139-25	25	£3.12
16.0D 6663 Double	20	B414142-25	25	£4.88
21.0D 6665 Double	5	B013366-25	25	£18.38
25.0D 6666 Double	5	B013374-25	25	£26.06

345pc Blanking Grommets

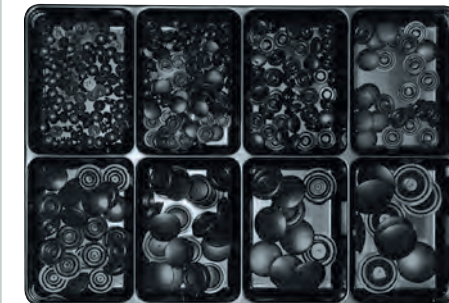

£58.85
Part No. B168966

Assortment Contents		Top Ups		
Description	Qty	Part No.	Qty	Price
6.4mm Blanking Grommets Black	100	B013404-25	25	£2.73
8.0mm Blanking Grommets Black	100	B013390-25	25	£3.96
9.5mm Blanking Grommets Black	50	B013412-25	25	£3.64
12.5mm Blanking Grommets Black	25	B013420-25	25	£5.25
15.5mm Blanking Grommets Black	25	B013382-25	25	£2.74
19.0mm Blanking Grommets Black	25	B013439-25	25	£3.84
22.5mm Blanking Grommets Black	10	B264814-25	25	£4.88
25.4mm Blanking Grommets Black	10	B264806-25	25	£9.26

125pc Mini, Midi and Maxi Blade Fuses



£62.50
Part No. 168965

Assortment Contents		Top Ups		
Description	Qty	Part No.	Qty	Price
5A Tan Mini Blade Fuses	5	B768430-100	100	£4.99
7.5A Brown Mini Blade Fuses	5	B768448-100	100	£4.99
10A Red Mini Blade Fuses	5	B768456-100	100	£4.99
15A Blue Mini Blade Fuses	5	B768464-100	100	£4.99
20A Yellow Mini Blade Fuses	5	B768472-100	100	£4.99
25A Natural Mini Blade Fuses	5	B768480-100	100	£4.99
30A Green Mini Blade Fuses	5	B768499-100	100	£4.99
5A Orange Midi Blade Fuses	10	B176885-100	100	£5.21
7.5A Brown Midi Blade Fuses	10	B176877-100	100	£5.21
10A Red Midi Blade Fuses	10	B176869-100	100	£5.21
15A Blue Midi Blade Fuses	10	B176850-100	100	£5.21
20A Yellow Midi Blade Fuses	10	B176842-100	100	£5.21
25A Natural Midi Blade Fuses	10	B176834-100	100	£5.21
30A Green Midi Blade Fuses	10	B176826-100	100	£5.21
30A Green Maxi Blade Fuses	5	B781692-10	10	£6.06
40A Saffron Maxi Blade Fuses	5	B781720-10	10	£6.06
50A Red Maxi Blade Fuses	5	B781711-10	10	£6.06
60A Blue Maxi Blade Fuses	5	B781703-10	10	£6.06

360pc DEUTSCH DT Connectors



£151.53
Part No. B367086

Assortment Contents		Top Ups		
Description	Qty	Part No.	Qty	Price
2 pin DT Male	10	B365885	10	£8.93
2 pin DT Female	10	B365892	10	£8.93
3 pin DT Male	10	B365886	10	£10.65
3 pin DT Female	10	B365893	10	£10.65
4 pin DT Male	10	B365887	10	£12.33
4 pin DT Female	10	B365894	10	£12.33
0.5-1.5mm DT Plug Pin	100	B365891	100	£35.75
0.5-1.5mm DT Plug Sleeve	100	B365898	100	£35.75
DT White Sealing Plug	100	B367078	100	£24.04

50pc Speedfit Nylon Straights



£98.71
Part No. 750799

Assortment Contents		Top Ups		
Description	Qty	Part No.	Qty	Price
4mm Speedfit Straight Couplings	10	730212	10	£13.31
5mm Speedfit Straight Couplings	10	730214	10	£12.94
6mm Speedfit Straight Couplings	10	730216	10	£13.18
8mm Speedfit Straight Couplings	10	730218	10	£13.55
10mm Speedfit Straight Couplings	5	730222	10	£17.78
12mm Speedfit Straight Couplings	5	730224	10	£19.27

48pc 50mm Quick Change Abrasive Discs



£175.68
Part No. B000676

Assortment Contents		Top Ups		
Description	Qty	Part No.	Qty	Price
50mm Mini Abrasive Flap Disc 40G	4	B175751	1	£3.89
50mm Mini Abrasive Flap Disc 60G	4	B175752	1	£4.00
50mm Mini Flexidiscs 40G	3	B173165-10	10	£46.99
50mm Mini Sanding Discs 36G	5	B139485-50	50	£40.28
50mm Mini Sanding Discs 60G	5	B139487-50	50	£42.71
50mm Mini Sanding Discs 80G	5	B139488-50	50	£40.28
50mm Mini Non-Woven Fabric Discs Course	5	B139497-50	50	£64.55
50mm Mini Non-Woven Fabric Discs Medium	5	B139496-50	50	£66.45
50mm Mini Non-Woven Fabric Discs Fine	5	B139495-50	50	£80.14
50mm Mini Cleaning Disc	3	B139500	1	£2.65
50mm Mini Compact Disc Medium	3	B175766	1	£8.35
50mm Roloc Backing Pad with 6mm Shank	1	B139508	1	£9.75

101pc ABC Brake Fittings Assortment



- ABC Quick Couplings
- Threadless adaptor
- Tube Release Tools
- Reducers
- Elbows
- Swivel Studs
- Male Studs
- ABC Rotolocks
- Blind Stops

£432.59
Part No. B136970

FULL CONTENTS ONLINE

71pc Truck Repair Maxi Stor Kit



- Bulkhead Locknut
- Straight Studs
- Elbow Swivels
- Tee Swivel Centres
- Tee Swivel Sides
- Tee Swivel Onrun
- Straight Swivels
- Bulkhead O Rings
- F Fitting Swivel
- Plugs

£291.83
Part No. 366076

FULL CONTENTS ONLINE

We supply a full range of fuses, fuse pullers, testers, fuse holders & other electrical products

SEE PAGES 7-9



700pc Black Cable Ties



£39.44

Part No. 994400

VIEW CONTENTS ONLINE

1400pc Black Cable Ties



£72.27

Part No. 994402

VIEW CONTENTS ONLINE

200pc RBGY 200 x 4.8mm Cable Ties



£10.75

Part No. VANAP41

9pc 1m 6-10mm BZP Threaded Rods



• Contents:
3 x M6, 3 x M8 and 3 x M10

£17.31

Part No. 540242

10pc 1.5m Flat Bar Mild Steel



VIEW CONTENTS ONLINE

£57.39

Part No. 540240

10pc 1.5m 3/16 - 1/2" Round Bars

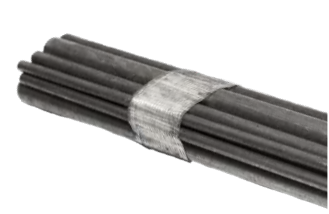

£46.10

Part No. 540186

5pc 1.5m Angle Iron Black Mild Steel



£46.90

Part No. 540190

1/2-3" General Purpose Paint Brushes



£11.15

Part No. 540238

10pc No. 2, 4, 6 & 8 Quality Touch Up Brushes



• Contents: 4 x No. 2, 3 x No.4, 2 x No.6 and 1 x No.8

£13.35

Part No. 540194

48pc 3.2-12.7 x 200mm Heatshrink Tubing



£9.22

Part No. 543114

4.8 x 200mm Coloured Heatshrink Tubes



£13.24

Part No. 540268

172pc Heatshrink Tubing



£17.12

Part No. 543116

100pc Mini Blade Fuses



£16.72

Part No. 543098

800pc Blade Fuses



£12.79

Part No. 542396

140pc 3/8-7/8in BZP O-Clips



£29.62

Part No. 543094

157pc 9-18mm Mini Hose Clips



£74.05

Part No. 900100

700pc No.8-12 BZP Pozi Pan Self Tapping Screws



£12.00

Part No. 543056

615pc No.6-10 BZP Pozi CSK Self Tapping Screws



£12.56

Part No. 543054

700pc No.6-10 Black Pozi Flange S/T Screws



£18.77

Part No. 543050

300pc 3-5mm BZP Steel Machine Screws and Nuts



£15.92

Part No. 542222

300pc Steel BA Screws and Nuts Round Head



£21.49

Part No. 542214

700pc No.4-12 BZP Pan Self Tapping Screw



£14.88

Part No. 542254

240pc 3/16 - 3/8" BZP Repair Washer



£12.90

Part No. 542266

250pc Copper Sealing Washer 5 to 17mm



£34.94

Part No. 543078

360pc Metric Copper Sealing Washers



£28.13

Part No. 543086

90pc Metric Copper Seal Washers



£36.21

Part No. 543080

225pc BSP Copper Sealing Washers



£25.87

Part No. 543082

280pc 12-25mm Circlips Ext/Int



£17.38

Part No. 542374

100pc BSP Dowty Washers



£19.42

Part No. 542314

90pc Metric Dowty Seals



£34.56

Part No. 543085

382pc Imperial O Rings



£20.00

Part No. 542310

404pc Metric O Rings



£18.93

Part No. 543092

3/16-1/2" Imperial Copper Washers



£44.46
Part No. 542218

Sump Plug Washers



£31.68
Part No. 543084

510pc U-J Nut and Speed Fasteners



£27.03
Part No. 542223

250pc No.6-14 U-Nuts & J-Nuts



£15.36
Part No. 542326

1000pc 1/16-5/32" BZP Split Pins



£18.75
Part No. 542258

225pc 1/8-5/16" BZP Split Pins



£16.37
Part No. 543088

300pc 2.5-8.0mm Metric Dowel/Roll Pins



£20.32
Part No. 542230

75pc 2.5 x 45-6 x 117mm BZP R Clip



£22.23
Part No. 540264

135pc Metric Grease Nipples Str/Angled Assortment



£32.32
Part No. 542306

Expansion Springs



£16.46
Part No. 542234

Hex Set Screws & Bolts BZP

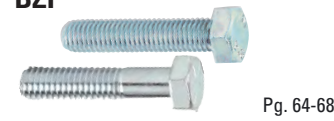

Pg. 64-68

Hex HT Set Screws & Bolts Self Colour



Pg. 68-69

Socket Head Screws Zinc & Stainless Steel



Pg. 69-70

Socket Countersunk Screws Zinc & Stainless Steel



Pg. 70-71

Serrated Flange Bolts



Pg. 71-72

Socket Button Head Screws



Pg. 72

Machine Screws



Pg. 72-73

Screwed Rod Stainless Steel, BZP & Mild Steel



Pg. 73

Hex Nuts BZP, Stainless Steel, A2



Pg. 73-74

Nyloc Nuts



Pg. 74

Serrated Flange Hex Nuts



Pg. 74

Flat Washers BZP & Stainless Steel



Pg. 75

Nylon Washer



Pg. 75

Repair Washers BZP & Stainless Steel



Pg. 75-76

Spring Washer BZP



Pg. 76

Copper Sealing Rings



Pg. 76

Fibre Washers



Pg. 77

Dowty Washers



Pg. 77

Nord Lock Retaining Washers



Pg. 77

O-Rings



Pg. 77

Surface Screw Cup Washers



Pg. 78

Nylon Nut Protectors



Pg. 78

Self Tapping Screws



Pg. 78-80

Shakeproof Washers



Pg. 78

Socket Dome Screws



Pg. 79

Countersunk Taptite Screws



Pg. 80

Floor Screws



Pg. 80

Cladfast Tek Screws



Pg. 80

Flanged Self Drilling Screw



Pg. 80

Hex Head Acme Screws



Pg. 80

Speed Fasteners



Pg.81

Number Plate Screws & Bolts



Pg. 81

R-Clips



Pg. 81

Linch Pins



Pg. 81

Split Pins & Cotter Pins



Pg. 81-82

Rivets



Pg. 82-83

Monobolts



Pg. 83

BZP Ball Joint Sockets



Pg. 83

Nutserts



Pg. 83

Chipboard Screws



Pg. 84

Hex Set Screws BZP



- DIN933
- Electroplated version
- Grade 8.8
- Hexagon fully headed screw with metric thread

M3

Part No.	Description	Qty	Price
B930510-200	M3 x 20mm	200	£8.50

M4

Part No.	Description	Qty	Price
B097098-200	M4 x 10mm	200	£5.87
B097101-200	M4 x 12mm	200	£5.20
245266	M4 x 16mm	500	£10.41
247200	M4 x 20mm	500	£11.96
247202	M4 x 25mm	250	£6.59
247204	M4 x 30mm	500	£16.75
247206	M4 x 35mm	500	£16.58
247208	M4 x 40mm	500	£21.41
B093556-200	M4 x 50mm	200	£13.04
B915123-200	M4 x 60mm	200	£24.04

M5

Part No.	Description	Qty	Price
245286	M5 x 10mm	500	£12.96
B097306-100	M5 x 12mm	100	£3.10
B97322-100	M5 x 16mm	100	£3.17
216206	M5 x 20mm	100	£4.50
247216	M5 x 20mm	500	£15.13
B915812-200	M5 x 22mm	200	£9.22
B97268-100	M5 x 25mm	100	£3.83
B97276-100	M5 x 30mm	100	£4.48
B097144-100	M5 x 35mm	100	£4.77
245292	M5 x 35mm	200	£8.70
247224	M5 x 40mm	100	£5.07
B097160-100	M5 x 45mm	100	£5.75
247226	M5 x 50mm	100	£4.83
B404144-100	M5 x 60mm	100	£7.78

M6

Part No.	Description	Qty	Price
B97462-100	M6 x 10mm	100	£3.27
B97454-100	M6 x 12mm	100	£3.53
B163538-100	M6 x 14mm	100	£3.67
247232	M6 x 16mm	100	£3.71
B097446-200	M6 x 18mm	200	£9.34

M6

Part No.	Description	Qty	Price
247234	M6 x 20mm	100	£3.88
B531073-100	M6 x 22mm	100	£5.27
247236	M6 x 25mm	100	£5.36
247238	M6 x 30mm	100	£5.16
247240	M6 x 35mm	100	£5.86
247242	M6 x 40mm	100	£6.03
B97381-100	M6 x 45mm	100	£8.34
247244	M6 x 50mm	100	£7.43
247246	M6 x 60mm	100	£8.54
245326	M6 x 65mm	200	£17.03
247248	M6 x 70mm	200	£16.68
247250	M6 x 75mm	100	£14.89
245324	M6 x 75mm	200	£14.67
245325	M6 x 80mm	100	£9.55
245327	M6 X 90mm	100	£11.43
245328	M6 x 100mm	100	£13.30

M7

Part No.	Description	Qty	Price
B097217-100	M7 x 20mm	100	£9.41
B097225-100	M7 x 25mm	100	£16.07
B097233-100	M7 x 30mm	100	£17.66
B404101-100	M7 x 35mm	100	£30.86
B404110-100	M7 x 40mm	100	£23.32
B404128-100	M7 x 45mm	100	£25.88
B404136-100	M7 x 50mm	100	£31.82
B915821-100	M7 x 60mm	100	£48.30

M8

Part No.	Description	Qty	Price
B097586-100	M8 x 12mm	100	£5.23
245331	M8 x 12mm	200	£9.21
B915824-100	M8 x 14mm	100	£5.20
247254	M8 x 16mm	100	£5.70
B097594-100	M8 x 18mm	100	£6.60
B915825-100	M8 x 22mm	100	£6.73
247258	M8 x 25mm	100	£6.86
216250	M8 x 25mm	200	£14.86
247260	M8 x 30mm	100	£7.72
247262	M8 x 35mm	100	£9.86
247264	M8 x 40mm	100	£9.52
245350	M8 x 45mm	200	£17.11
247268	M8 x 50mm	100	£10.29
B097551-100	M8 x 55mm	100	£13.51
247270	M8 x 60mm	100	£16.04
B404179-100	M8 x 65mm	100	£15.21
247272	M8 x 70mm	100	£15.87

M8

Part No.	Description	Qty	Price
247274	M8 x 75mm	100	£19.52
216275	M8 x 80mm	200	£33.74
245355	M8 x 80mm	100	£17.18
245356	M8 x 90mm	100	£19.62
B404225-50	M8 x 100mm	50	£11.76
B532088-50	M8 x 110mm	50	£11.97
B404233-50	M8 x 120mm	50	£12.86
B049880-100	M8 x 130mm	100	£38.86
B049881-25	M8 x 140mm	25	£13.52
B049882-10	M8 x 150mm	10	£7.36

M10

Part No.	Description	Qty	Price
B404241-100	M10 x 12mm	100	£13.96
B097683-100	M10 x 16mm	100	£11.80
245363	M10 x 16mm	200	£17.14
B126203-200	M10 x 18mm	200	£26.33
247282	M10 x 20mm	100	£12.00
B097705-200	M10 x 22mm	200	£27.49
247284	M10 x 25mm	100	£10.44
247286	M10 x 30mm	100	£11.96
247288	M10 x 35mm	100	£17.50
245368	M10 x 40mm	100	£12.65
247292	M10 x 45mm	50	£8.48
245369	M10 x 45mm	100	£18.51
245372	M10 x 50mm	100	£16.51
B097721-100	M10 x 55mm	100	£30.60
245376	M10 x 60mm	100	£22.00
245367	M10 x 65mm	100	£23.78
247300	M10 x 70mm	50	£13.05
B404276-25	M10 x 75mm	25	£7.21
247304	M10 x 80mm	50	£12.96
B404292-50	M10 x 90mm	50	£17.31
247308	M10 x 100mm	50	£19.06
B915838-50	M10 x 110mm	50	£18.30
B404314-50	M10 x 120mm	50	£25.01
245377	M10 x 130mm	50	£26.63
B404322-10	M10 x 140mm	10	£5.09
B404330-10	M10 x 150mm	10	£7.43
B049886-10	M10 x 160mm	10	£8.53

M12

Part No.	Description	Qty	Price
245401	M12 x 25mm	100	£27.06
247334	M12 x 30mm	50	£13.56
216323	M12 x 35mm	100	£28.56
245600	M12 x 40mm	50	£15.66
245604	M12 x 45mm	50	£16.30
245608	M12 x 50mm	50	£16.72
B404535-50	M12 x 55mm	50	£21.97
245616	M12 x 60mm	50	£20.60
245620	M12 x 65mm	50	£21.67
B404551-50	M12 x 70mm	50	£25.67
B915860-50	M12 x 75mm	50	£32.69
247350	M12 x 80mm	10	£6.09
245628	M12 x 80mm	25	£15.75
B915861-25	M12 x 90mm	25	£15.50
245480	M12 x 100mm	25	£15.28
B126229-50	M12 x 110mm	50	£54.90
B915863-25	M12 x 120mm	25	£18.59
B126230-50	M12 x 130mm	50	£76.99
B126231-50	M12 x 140mm	50	£71.75

M12 Cont.

Part No.	Description	Qty	Price
245382	M12 x 30mm	100	£17.15
245384	M12 x 35mm	100	£22.62
245386	M12 x 40mm	100	£21.80
247320	M12 x 45mm	50	£12.72
247322	M12 x 50mm	50	£14.58
B097802-50	M12 x 55mm	50	£17.20
247324	M12 x 60mm	50	£15.35
245389	M12 x 65mm	50	£16.06
247325	M12 x 70mm	50	£20.54
245394	M12 x 75mm	50	£21.07
245393	M12 x 80mm	50	£16.85
B075636-50	M12 x 85mm	50	£17.29
245385	M12 x 90mm	50	£19.22
245391	M12 x 100mm	50	£18.50
B404420-25	M12 x 110mm	25	£11.88
245397	M12 x 120mm	25	£13.82
B404446-25	M12 x 130mm	25	£14.43
B915851-50	M12 x 140mm	50	£32.08
B404454-50	M12 x 150mm	50	£34.76
B049887-25	M12 x 160mm	25	£18.32
B049888-10	M12 x 180mm	10	£12.47

M12 Cont.

Part No.	Description	Qty	Price
245382	M12 x 30mm	100	£17.15
245384	M12 x 35mm	100	£22.62
245386	M12 x 40mm	100	£21.80
247320	M12 x 45mm	50	£12.72
247322	M12 x 50mm	50	£14.58
B097802-50	M12 x 55mm	50	£17.20
247324	M12 x 60mm	50	£15.35
245389	M12 x 65mm	50	£16.06
247325	M12 x 70mm	50	£20.54
245394	M12 x 75mm	50	£21.07
245393	M12 x 80mm	50	£16.85
B075636-50	M12 x 85mm	50	£17.29
245385	M12 x 90mm	50	£19.22
245391	M12 x 100mm	50	£18.50
B404420-25	M12 x 110mm	25	£11.88
245397	M12 x 120mm	25	£13.82
B404446-25	M12 x 130mm	25	£14.43
B915851-50	M12 x 140mm	50	£32.08
B404454-50	M12 x 150mm	50	£34.76
B049887-25	M12 x 160mm	25	£18.32
B049888-10	M12 x 180mm	10	£12.47

M14

Part No.	Description	Qty	Price
245401	M14 x 25mm	100	£27.06
247334	M14 x 30mm	50	£13.56
216323	M14 x 35mm	100	£28.56
245600	M14 x 40mm	50	£15.66
245604	M14 x 45mm	50	£16.30
245608	M14 x 50mm	50	£16.72
B404535-50	M14 x 55mm	50	£21.97
245616	M14 x 60mm	50	£20.60
245620	M14 x 65mm	50	£21.67
B404551-50	M14 x 70mm	50	£25.67
B915860-50	M14 x 75mm	50	£32.69
247350	M14 x 80mm	10	£6.09
245628	M14 x 80mm	25	£15.75
B915861-25	M14 x 90mm	25	£15.50
245480	M14 x 100mm	25	£15.28
B126229-50	M14 x 110mm	50	£54.90
B915863-25	M14 x 120mm	25	£18.59
B126230-50	M14 x 130mm	50	£76.99
B126231-50	M14 x 140mm	50	£71.75

M16

Part No.	Description	Qty	Price
B404586-50	M16 x 20mm	50	£18.61

M16

Part No.	Description
----------	-------------

Hex HT Bolts BZP



- DIN933
- Electroplated version
- Grade 8.8
- Hexagon with metric coarse thread

M4

Part No.	Description	Qty	Price
B930612-200	M4 x 50mm	200	£15.16
B052620-200	M4 x 60mm	200	£23.13

M5

Part No.	Description	Qty	Price
245411	M5 x 25mm	500	£19.04
B097888-100	M5 x 30mm	100	£5.28
216981	M5 x 35mm	200	£6.39
B405280-100	M5 x 40mm	100	£8.25
B097918-100	M5 x 45mm	100	£7.49
B097926-100	M5 x 50mm	100	£7.73
B405302-100	M5 x 60mm	100	£11.58
B405310-100	M5 x 70mm	100	£11.40
B405329-100	M5 x 80mm	100	£13.07

M6

Part No.	Description	Qty	Price
245530	M6 x 25mm	500	£22.22
B097934-100	M6 x 30mm	100	£5.45
247612	M6 x 30mm	500	£23.44
217000	M6 x 35mm	200	£14.71
B097950-100	M6 x 40mm	100	£9.19
B097969-100	M6 x 45mm	100	£8.60
247618	M6 x 50mm	100	£7.73
B097985-100	M6 x 55mm	100	£11.18
247620	M6 x 60mm	200	£22.33
247624	M6 x 70mm	100	£10.10
214234	M6 x 75mm	200	£17.40
B098027-100	M6 x 80mm	100	£10.91
247628	M6 x 90mm	100	£14.31
B405345-100	M6 x 100mm	100	£13.70
B405353-100	M6 x 110mm	100	£15.54
B405361-100	M6 x 120mm	100	£19.15

M7

Part No.	Description	Qty	Price
B405388-100	M7 x 35mm	100	£37.77
B405426-100	M7 x 60mm	100	£31.66

M8

Part No.	Description	Qty	Price
247632	M8 x 30mm	100	£9.38
217013	M8 x 35mm	200	£21.09
245413	M8 x 40mm	100	£12.36
217015	M8 x 45mm	200	£18.84
245416	M8 x 50mm	100	£12.10
247640	M8 x 60mm	100	£14.25
217017	M8 x 65mm	200	£24.44
247642	M8 x 70mm	100	£15.74
B098116-100	M8 x 75mm	100	£17.85
247644	M8 x 80mm	100	£18.12
217026	M8 x 80mm	200	£35.05
B027506-25	M8 x 85mm	25	£6.28
B098132-50	M8 x 90mm	50	£13.96
B125799-100	M8 x 95mm	100	£23.53
B405450-50	M8 x 100mm	50	£13.28
217027	M8 x 100mm	100	£20.52
217028	M8 x 110mm	100	£23.89
B125800-100	M8 x 115mm	100	£42.05
217029	M8 x 120mm	50	£11.95
B405485-50	M8 x 130mm	50	£15.72
B405493-50	M8 x 140mm	50	£18.03
B405507-50	M8 x 150mm	50	£26.83
B405515-25	M8 x 160mm	25	£11.06
B405523-100	M8 x 170mm	100	£56.91
B528870-100	M8 x 180mm	100	£124.30
B125804-100	M8 x 190mm	100	£105.71

M10

Part No.	Description	Qty	Price
247650	M10 x 35mm	100	£16.75
245415	M10 x 40mm	100	£17.82
247654	M10 x 45mm	100	£17.61
245417	M10 x 50mm	100	£17.94
B098175-100	M10 x 55mm	100	£21.97
247660	M10 x 60mm	100	£22.80
214285	M10 x 65mm	100	£22.51
247662	M10 x 70mm	50	£15.55
247664	M10 x 75mm	50	£14.95
217055	M10 x 75mm	100	£37.95
247666	M10 x 80mm	50	£15.86
B098230-50	M10 x 85mm	50	£15.86
247668	M10 x 90mm	50	£17.82
B125807-100	M10 x 95mm	100	£38.29
247670	M10 x 100mm	50	£16.24
217059	M10 x 110mm	50	£25.60
B125809-50	M10 x 115mm	50	£42.66

M10

Part No.	Description	Qty	Price
217062	M10 x 120mm	50	£20.04
B405558-25	M10 x 130mm	25	£19.45
B405566-25	M10 x 140mm	25	£13.30
B405574-25	M10 x 150mm	25	£13.50
B405582-25	M10 x 160mm	25	£16.25
B405590-10	M10 x 170mm	10	£9.92
B513156-25	M10 x 180mm	25	£19.36
B125810-50	M10 x 190mm	50	£41.71
B102967-25	M10 x 200mm	25	£21.42
B125811-50	M10 x 210mm	50	£85.82
B102968-50	M10 x 220mm	50	£91.26
B125812-50	M10 x 230mm	50	£99.65
B102969-50	M10 x 240mm	50	£99.19
B125813-50	M10 x 250mm	50	£120.44

M12

Part No.	Description	Qty	Price
247674	M12 x 40mm	100	£21.34
B098264-50	M12 x 45mm	50	£13.24
B98272-50	M12 x 50mm	50	£16.04
217065	M12 x 55mm	50	£15.14
B98299-50	M12 x 60mm	50	£15.72
217074	M12 x 70mm	50	£18.90
247686	M12 x 75mm	50	£19.11
247688	M12 x 80mm	50	£22.57
B405604-50	M12 x 85mm	50	£25.52
247690	M12 x 90mm	50	£27.16
B405620-50	M12 x 95mm	50	£33.54
245424	M12 x 100mm	50	£27.42
247694	M12 x 110mm	25	£12.38
247696	M12 x 120mm	25	£13.76
247698	M12 x 130mm	25	£17.38
247700	M12 x 140mm	25	£16.96
247702	M12 x 150mm	25	£16.93
B405698-25	M12 x 160mm	25	£20.49
B405701-25	M12 x 170mm	25	£24.18
B405710-10	M12 x 180mm	10	£10.84
B125820-25	M12 x 190mm	25	£29.68
B405728-10	M12 x 200mm	10	£11.08
B125821-25	M12 x 210mm	25	£47.34
B530140-10	M12 x 220mm	10	£16.53
B125823-25	M12 x 230mm	25	£42.19
B530158-25	M12 x 240mm	25	£59.64
B125824-25	M12 x 250mm	25	£74.17
B915670-25	M12 x 260mm	25	£46.37
B075669-25	M12 x 280mm	25	£49.59

M14

Part No.	Description	Qty	Price
247708	M14 x 50mm	50	£20.00
B405744-50	M14 x 55mm	50	£22.43
247712	M14 x 60mm	25	£13.11
B405779-50	M14 x 70mm	50	£31.88
B405787-10	M14 x 75mm	10	£6.07
245566	M14 x 80mm	50	£25.84
B125831-50	M14 x 85mm	50	£40.79
245568	M14 x 90mm	50	£28.04
B125832-50	M14 x 95mm	50	£49.17
245574	M14 x 100mm	25	£17.76
B405825-25	M14 x 110mm	25	£22.61
245576	M14 x 120mm	25	£24.64
B405841-25	M14 x 130mm	25	£27.42
B405850-25	M14 x 140mm	25	£27.71
245580	M14 x 150mm	25	£28.38
B405876-25	M14 x 160mm	25	£36.47
B405884-10	M14 x 170mm	10	£17.73
B405892-10	M14 x 180mm	10	£19.45
B405906-25	M14 x 190mm	25	£53.71
B405914-10	M14 x 200mm	10	£20.79
B125833-25	M14 x 220mm	25	£51.36

M16

Part No.	Description	Qty	Price
245844	M16 x 50mm	50	£26.98
B098353-50	M16 x 55mm	50	£31.27
245848	M16 x 60mm	50	£32.03
B405922-25	M16 x 65mm	25	£24.99
245510	M16 x 70mm	25	£18.34
245511	M16 x 75mm	25	£18.74
245512	M16 x 80mm	25	£19.43
B125835-25	M16 x 85mm	25	£20.08
245513	M16 x 90mm	25	£23.96
B125836-25	M16 x 95mm	25	£24.95
245517	M16 x 100mm	25	£25.48
B405981-25	M16 x 110mm	25	£25.85
245521	M16 x 120mm	25	£26.46
B406007-25	M16 x 130mm	25	£30.20
245525	M16 x 150mm	25	£35.26
245529	M16 x 160mm	25	£42.90
B406040-10	M16 x 170mm	10	£23.88
B406058-10	M16 x 180mm	10	£18.10
B406066-25	M16 x 190mm	25	£51.96
B406074-10	M16 x 200mm	10	£19.82
B125837-25	M16 x 210mm	25	£85.39

M16 Cont.

Part No.	Description	Qty	Price
B406082-10	M16 x 220mm	10	£26.19
B406090-10	M16 x 240mm	10	£40.17
B406112-10	M16 x 280mm	10	£42.11
B406120-10	M16 x 300mm	10	£48.22

M18

Part No.	Description	Qty	Price
B406139-25	M18 x 60mm	25	£22.21
B406147-25	M18 x 65mm	25	£34.52
B406155-25	M18 x 70mm	25	£34.98
B406163-10	M18 x 75mm	10	£12.49
B406171-25	M18 x 80mm	25	£37.29
B406180-10	M18 x 90mm	10	£14.29
B125856-25	M18 x 95mm	25	£56.63
B406198-10	M18 x 100mm	10	£15.61
B406201-10	M18 x 110mm	10	£18.21
B406210-10	M18 x 120mm	10	£19.54
B406228-10	M18 x 130mm	10	£23.39
B406236-10	M18 x 140mm	10	£24.62
B513164-10	M18 x 150mm	10	£25.86
B406244-10	M18 x 160mm	10	£29.40
B125857-25	M18 x 170mm	25	£62.84
B406252-10	M18 x 180mm	10	£37.94

M20

Part No.	Description	Qty	Price
B513180-25	M20 x 60mm	25	£26.74
B406260-25	M20 x 65mm	25	£27.83
245914	M20 x 70mm	25	£33.56
B513199-25	M20 x 75mm	25	£30.55
B406287-25	M20 x 80mm	25	£52.84
B406295-25	M20 x 90mm	25	£33.65
B406309-25	M20 x 100mm	25	£47.08
B406317-10	M20 x 110mm	10	£18.56
245870	M20 x 120mm	10	£17.74
245920	M20 x 130mm	10	£15.85
B406341-10	M20 x 140mm	10	£19.12
B406350-10	M20 x 150mm	10	£25.12
B406368-10	M20 x 160mm	10	£24.73
B406384-10			

M30

Part No.	Description	Qty	Price
B046630-5	M30 x 80mm	5	£28.44
B915793-5	M30 x 90mm	5	£35.83
B406759-5	M30 x 100mm	5	£48.86
B406775-5	M30 x 120mm	5	£38.34
B915797-5	M30 x 130mm	5	£38.45
B046632-5	M30 x 140mm	5	£42.70
B406791-5	M30 x 160mm	5	£46.92
B406813-5	M30 x 180mm	5	£71.70
B915802-5	M30 x 200mm	5	£70.61

Hex Set Screws Self Colour

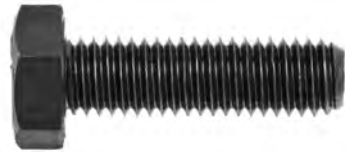

- DIN933
- Grade 8.8
- Hexagon with metric coarse thread

M4

Part No.	Description	Qty	Price
216192	M4 x 20mm	500	£12.35

M5

Part No.	Description	Qty	Price
216204	M5 x 10mm	500	£17.70
216208	M5 x 25mm	200	£5.69
216146	M5 x 50mm	200	£11.22

M6

Part No.	Description	Qty	Price
216210	M6 x 12mm	500	£11.53
216212	M6 x 16mm	500	£15.59
216214	M6 x 20mm	500	£16.37
216230	M6 x 40mm	200	£8.00
216234	M6 x 45mm	200	£15.83
216238	M6 x 50mm	200	£14.83
216241	M6 x 100mm	100	£10.99

M8

Part No.	Description	Qty	Price
216242	M8 x 12mm	200	£10.99
216244	M8 x 16mm	200	£9.03
216246	M8 x 20mm	200	£11.58
216250	M8 x 25mm	200	£14.86
216254	M8 x 30mm	200	£20.76
216262	M8 x 40mm	200	£21.92
216270	M8 x 50mm	200	£27.17
216279	M8 x 100mm	100	£15.51

M10

Part No.	Description	Qty	Price
216282	M10 x 30mm	100	£11.64
216294	M10 x 45mm	100	£15.30
216298	M10 x 50mm	100	£14.72
216295	M10 x 55mm	100	£15.90
216300	M10 x 75mm	100	£30.91
216285	M10 x 100mm	100	£31.66

M12

Part No.	Description	Qty	Price
216302	M12 x 20mm	100	£14.13
216306	M12 x 25mm	50	£11.97
216310	M12 x 30mm	100	£23.25
216346	M12 x 65mm	50	£19.14
216402	M12 x 100mm	50	£19.92

M14

Part No.	Description	Qty	Price
216424	M14 x 70mm	50	£20.52
216428	M14 x 80mm	50	£23.93
216432	M14 x 90mm	50	£23.90

M16

Part No.	Description	Qty	Price
216331	M16 x 35mm	25	£7.32
216338	M16 x 50mm	50	£25.61
216351	M16 x 70mm	25	£14.31
216352	M16 x 75mm	25	£15.21
216358	M16 x 80mm	25	£16.21
216362	M16 x 100mm	25	£19.55

M20

Part No.	Description	Qty	Price
B600617	M20 x 45mm	25	£17.57
216452	M20 x 65mm	25	£23.18

M30

Part No.	Description	Qty	Price
247275	M30 x 60mm	5	£23.79

Hex HT Bolts Self Colour



- DIN931
- Grade 8.8
- Hexagon with metric coarse thread

M5

Part No.	Description	Qty	Price
214202	M5 x 60mm	200	£11.35

M6

Part No.	Description	Qty	Price
214218	M6 x 40mm	200	£12.17

M8

Part No.	Description	Qty	Price
214238	M8 x 30mm	200	£18.10
214242	M8 x 35mm	200	£16.52
214246	M8 x 40mm	200	£19.90
214250	M8 x 45mm	200	£21.00
214262	M8 x 75mm	200	£28.61

M10

Part No.	Description	Qty	Price
214266	M10 x 35mm	100	£20.50
214290	M10 x 80mm	100	£27.20
214299	M10 x 120mm	50	£22.76

M12

Part No.	Description	Qty	Price
214306	M12 x 50mm	50	£17.24
214310	M12 x 60mm	50	£20.13
214312	M12 x 70mm	50	£18.78
214318	M12 x 80mm	50	£19.36
214328	M12 x 130mm	50	£26.62
214332	M12 x 150mm	50	£28.24
B600600	M12 x 180mm	25	£19.32

M14

Part No.	Description	Qty	Price
214350	M14 x 75mm	50	£24.31

M16

Part No.	Description	Qty	Price
214345	M16 x 45mm	25	£19.04
214357	M16 x 90mm	25	£20.01
214496	M16 x 120mm	25	£43.26

M18

Part No.	Description	Qty	Price
750100	M18 x 80mm	25	£19.44

M20

Part No.	Description	Qty	Price
B600623	M20 x 75mm	25	£28.80
750105	M20 x 110mm	25	£32.76

M24

Part No.	Description	Qty	Price
750110	M24 x 120mm	10	£24.33

Socket Head Screws Zinc



- DIN912 (ISO 4762)
- Grade 8.8
- Zinc plated

M4

Part No.	Description	Qty	Price
B109910-200	M4 x 6mm	200	£7.84
B99953-200	M4 x 8mm	200	£7.15
B099988-200	M4 x 10mm	200	£8.67
B99996-200	M4 x 12mm	200	£9.13
B100005-200	M4 x 16mm	200	£8.39
B100021-200	M4 x 20mm	200	£9.33
B100048-200	M4 x 25mm	200	£9.87
B100056-200	M4 x 30mm	200	£10.49
B930410-200	M4 x 35mm	200	£11.23
B100072-200	M4 x 40mm	200	£13.21
B930411-200	M4 x 50mm	200	£20.43

M5

Part No.	Description	Qty	Price
B100129-100	M5 x 10mm	100	£3.61
B100137-100	M5 x 12mm	100	£4.82
B100145-100	M5 x 16mm	100	£4.85
B100161-100	M5 x 20mm	100	£5.87
B100188-100	M5 x 25mm	100	£4.94
B100196-100	M5 x 30mm	100	£6.35
B100200-100	M5 x 35mm	100	£7.23
B100218-100	M5 x 40mm	100	£7.50
B915985-100	M5 x 45mm	100	£7.57
B100234-100	M5 x 50mm	100	£7.96
B100250-100	M5 x 60mm	100	£9.08
B120797-100	M5 x 70mm	100	£12.10
B120798-100	M5 x 80mm	100	£16.51

M6

Part No.	Description	Qty	Price
B100285-100	M6 x 8mm	100	£5.37
B100293-100	M6 x 10mm	100	£5.60

M6

Part No.	Description	Qty	Price
B100307-100	M6 x 12mm	100	£5.79
B100315-100	M6 x 16mm	100	£5.89
B100331-100	M6 x 20mm	100	£6.84
B100358-100	M6 x 25mm	100	£6.97
B100366-100	M6 x 30mm	100	£7.17
B100374-100	M6 x 35mm	100	£7.57
B100382-100	M6 x 40mm	100	£8.40
B100390-100	M6 x 45mm	100	£9.63
B100404-100	M6 x 50mm	100	£10.23
B100412-100	M6 x 55mm	100	£10.80
B100420-100	M6 x 60mm	100	£12.98
B100439-100	M6 x 65mm	100	£15.21
B100447-100	M6 x 70mm	100	£16.14
B100455-100	M6 x 80mm	100	£16.53
B100498-50	M6 x 90mm	50	£13.57
B100463-50	M6 x 100mm	50	£10.31

M8

Part No.	Description	Qty	Price
B100528-100	M8 x 10mm	100	£8.57
B100480-100	M8 x 12mm	100	£10.16
B100536-100	M8 x 16mm	100	£9.59
B100544-100	M8 x 18mm	100	£10.58
B100552-100	M8 x 20mm	100	£9.82
B100579-100	M8 x 25mm	100	£10.46
B100587-100	M8 x 30mm	100	£14.34
B100595-100	M8 x 35mm	100	£12.25
B100609-100	M8 x 40mm	100	£18.45
B100617-100	M8 x 45mm	100	£15.52
B100625-100	M8 x 50mm	100	£15.99
B100633-50	M8 x 55mm	50	£9.78
B100641-50	M8 x 60mm	50	£9.79
B100730-50	M8 x 65mm	50	£10.95
B100650-50	M8 x 70mm	50	£11.44
B100668-50	M8 x 80mm	50	£12.60
B100676-50	M8 x 90mm	50	£14.81
B100684-50	M8 x 100mm	50	£15.37
B100692-50	M8 x 110mm	50	£20.47
B100706-50	M8 x 120mm	50	£20.52

M10

Part No.	Description	Qty	Price
B100757-100	M10 x 16mm	100	£13.56
B100773-100	M10 x 20mm	100	£15.20
B100790-100	M10 x 25mm	100	£16.12
B100803-100	M10 x 30mm	100	£22.08
B100811-100	M10 x 35mm	100	£20.01
B100820-100	M10 x 40mm	100	£20.86
B100838-100	M10 x 45mm	100	£22.40
B100846-100	M10 x 50mm	100	£24.31
B100854-50	M10 x 55mm	50	£13.38
B100862-50	M10 x 60mm	50	£16.94
B100889-50	M10 x 70mm	50	£17.22
B100900-50	M10 x 80mm	50	£19.17
B100919-25	M10 x 90mm	25	£12.46
B100927-25	M10 x 100mm	25	£16.43
B100935-25	M10 x 110mm	25	£17.05
B133055-2			

M16

Part No.	Description	Qty	Price
B930430-25	M16 x 30mm	25	£13.81
B591475-25	M16 x 40mm	25	£16.94
B51321-10	M16 x 45mm	10	£10.67
B591483-25	M16 x 50mm	25	£18.56
B520322-25	M16 x 60mm	25	£18.58
B849140-25	M16 x 70mm	25	£19.40
B849157-25	M16 x 80mm	25	£23.64
B133063-25	M16 x 90mm	25	£28.09
B938426-25	M16 x 100mm	25	£28.00
B51322-10	M16 x 110mm	10	£12.29
B133064-25	M16 x 120mm	25	£52.12

M20

Part No.	Description	Qty	Price
B938404-25	M20 x 30mm	25	£50.79
B161671-10	M20 x 90mm	10	£20.25
B161674-25	M20 x 140mm	25	£85.98
B51328-10	M20 x 150mm	10	£22.54

Socket Head Cap Screws A2



- DIN912 (ISO 4762)
- Stainless steel

M4

Part No.	Description	Qty	Price
B094889-200	M4 x 6mm	200	£6.86
B354759-200	M4 x 8mm	200	£6.37
B354767-200	M4 x 10mm	200	£6.29
B354775-200	M4 x 12mm	200	£6.74
B354783-200	M4 x 16mm	200	£7.27
B354791-200	M4 x 20mm	200	£8.27
B354805-200	M4 x 25mm	200	£9.60
B354813-200	M4 x 30mm	200	£11.04
B516945-200	M4 x 40mm	200	£15.25

M5

Part No.	Description	Qty	Price
B094896-100	M5 x 8mm	100	£4.62
B354821-100	M5 x 10mm	100	£5.16
B354830-100	M5 x 12mm	100	£5.45
B354848-100	M5 x 16mm	100	£5.60
B354856-100	M5 x 20mm	100	£6.48
B354864-100	M5 x 25mm	100	£7.70
B354872-100	M5 x 30mm	100	£8.72

M5

Part No.	Description	Qty	Price
B354899-100	M5 x 40mm	100	£9.60
B133079-200	M5 x 45mm	200	£26.58
B116018-200	M5 x 60mm	200	£33.67
B116019-200	M5 x 70mm	200	£38.63

M6

Part No.	Description	Qty	Price
B135477-100	M6 x 8mm	100	£9.12
B031932-100	M6 x 10mm	100	£8.32
B354902-100	M6 x 12mm	100	£9.82
B354910-100	M6 x 16mm	100	£11.24
B109649-100	M6 x 20mm	100	£11.34
B109657-100	M6 x 25mm	100	£11.41
B109665-100	M6 x 30mm	100	£11.52
B354929-100	M6 x 35mm	100	£13.64
B109673-100	M6 x 40mm	100	£16.60
B354937-100	M6 x 45mm	100	£18.06
B354945-100	M6 x 50mm	100	£19.54
B354953-100	M6 x 60mm	100	£24.50

M8

Part No.	Description	Qty	Price
B032420-200	M8 x 10mm	200	£33.75
B160117-200	M8 x 12mm	200	£33.53
B354970-100	M8 x 16mm	100	£13.61
B354988-100	M8 x 20mm	100	£15.74
B354996-100	M8 x 25mm	100	£16.54
B109720-100	M8 x 30mm	100	£19.60
B355003-100	M8 x 35mm	100	£21.88
B355020-100	M8 x 45mm	100	£26.27
B355038-100	M8 x 50mm	100	£28.46
B355054-100	M8 x 60mm	100	£33.26
B355062-50	M8 x 70mm	50	£19.21
B355070-50	M8 x 80mm	50	£22.33
B133080-100	M8 x 90mm	100	£49.67

M10

Part No.	Description	Qty	Price
B109762-100	M10 x 20mm	100	£27.19
B109770-100	M10 x 25mm	100	£29.84
B355089-100	M10 x 30mm	100	£31.69
B355097-100	M10 x 35mm	100	£35.77
B109797-100	M10 x 40mm	100	£37.50
B355119-50	M10 x 50mm	50	£22.67
B355127-50	M10 x 60mm	50	£26.19

Socket Countersunk Screws



- DIN7791 (ISO 10642)
- Grade 8.8
- Zinc

M3

Part No.	Description	Qty	Price
B052664-100	M3 x 10mm	100	£5.28
B052665-100	M3 x 16mm	100	£5.54
B117958-100	M3 x 20mm	100	£7.17

M4

Part No.	Description	Qty	Price
B938728-100	M4 x 10mm	100	£5.19
B052666-100	M4 x 16mm	100	£5.32
B938429-100	M4 x 20mm	100	£6.16
B517003-100	M4 x 25mm	100	£6.24

M5

Part No.	Description	Qty	Price
B101958-100	M5 x 10mm	100	£6.52
B101966-100	M5 x 12mm	100	£6.56
B938448-100	M5 x 16mm	100	£6.95
B101982-100	M5 x 20mm	100	£7.17
B101990-100	M5 x 25mm	100	£7.66
B102008-100	M5 x 30mm	100	£8.58

M6

Part No.	Description	Qty	Price
B102016-100	M6 x 10mm	100	£7.59
B102024-100	M6 x 12mm	100	£8.76
B102032-100	M6 x 16mm	100	£9.09
B102040-100	M6 x 20mm	100	£9.22
B102059-100	M6 x 25mm	100	£9.35
B102067-100	M6 x 30mm	100	£9.59
B517070-100	M6 x 35mm	100	£13.17
B517020-100	M6 x 40mm	100	£13.27
B938578-50	M6 x 50mm	50	£14.54

M8

Part No.	Description	Qty	Price
B102113-100	M8 x 16mm	100	£10.04
B102121-100	M8 x 20mm	100	£10.90
B102130-100	M8 x 25mm	100	£12.85
B102148-100	M8 x 30mm	100	£14.49
B102156-100	M8 x 35mm	100	£16.56

M8

Part No.	Description	Qty	Price
B102164-100	M8 x 40mm	100	£17.62
B102172-50	M8 x 50mm	50	£8.37
B938397-50	M8 x 60mm	50	£17.88

M10

Part No.	Description	Qty	Price
B102199-100	M10 x 20mm	100	£21.19
B102202-100	M10 x 25mm	100	£22.04
B102210-100	M10 x 30mm	100	£22.99
B517054-50	M10 x 35mm	50	£14.19
B102237-50	M10 x 40mm	50	£15.27
B102245-50	M10 x 50mm	50	£17.36
B517062-50	M10 x 60mm	50	£32.15

M12

Part No.	Description	Qty	Price
B117982-50	M12 x 20mm	50	£17.75
B102270-50	M12 x 30mm	50	£19.80
B117983-50	M12 x 35mm	50	£20.68
B102296-50	M12 x 40mm	50	£22.32
B102318-50	M12 x 50mm	50	£22.83
B117987-50	M12 x 60mm	50	£28.31
B117988-50	M12 x 70mm	50	£34.11

Socket Countersunk Screws A2



- DIN7991
- Stainless steel

M3

Part No.	Description	Qty	Price
B157667-200	M3 x 16mm	200	£7.91

M4

Part No.	Description	Qty	Price
B517801-100	M4 x 8mm	100	£2.87
B024006-200	M4 x 10mm	200	£4.49
B517828-200	M4 x 12mm	200	£5.46
B517836-200	M4 x 16mm	200	£6.28
B024008-200	M4 x 20mm	200	£7.59
B115984-200	M4 x 25mm	200	£8.06
B115985-200	M4 x 30mm	200	£11.03
B115987-100	M4 x 40mm	100	£7.89

M5

Part No.	Description	Qty	Price
B024009-100	M5 x 10mm	100	£4.81
B103013-100	M5 x 12mm	100	£5.64
B024010-100	M5 x 16mm	100	£5.94
B024011-100	M5 x 20mm	100	£6.93
B024012-100	M5 x 25mm	100	£7.98
B024013-100	M5 x 30mm	100	£9.53
B356077-100	M5 x 35mm	100	£11.61
B356085-100	M5 x 40mm	100	£13.18
B115990-100	M5 x 50mm	100	£15.96
B115992-200	M5 x 60mm	200	£38.89

M6

Part No.	Description	Qty	Price
B356093-100	M6 x 10mm	100	£6.13
B356107-100	M6 x 12mm	100	£7.52
B356115-100	M6 x 16mm	100	£8.46
B517852-100	M6 x 20mm	100	£10.16
B024016-100	M6 x 25mm	100	£10.91
B024017-100	M6 x 30mm	100	£11.61
B356140-100	M6 x 35mm	100	£12.40
B356158-100	M6 x 40mm	100	£12.49
B356166-100	M6 x 45mm	100	£17.38
B356174-100	M6 x 50mm	100	£19.15
B115993-100	M6 x 55mm	100	£21.14
B109909-100	M6 x 60mm	100	£23.29
B115995-100	M6 x 70mm	100	£29.81
B115996-100	M6 x 80mm	100	£30.17
B096649-100	M6 x 100mm	100	£35.64

M8

Part No.	Description	Qty	Price
B024018-100	M8 x 20mm	100	£13.04
B024019-100	M8 x 25mm	100	£14.33
B024020-100	M8 x 30mm	100	£17.42
B356220-100	M8 x 35mm	100	£18.88
B024021-100	M8 x 40mm	100	£20.06
B024022-100	M8 x 50mm	100	£21.98
B115998-100	M8 x 60mm	100	£24.22
B115999-50	M8 x 70mm	50	£19.79
B116000-50	M8 x 80mm	50	£23.12
B096652-50	M8 x 90mm	50	£30.81
B096653-50	M8 x 100mm	50	£32.22

M10

Part No.	Description	Qty	Price
B356263-50	M10 x 20mm	50	£10.16
B356271-50	M10 x 25mm	50	£11.63
B024024-50	M10 x 30mm	50	£13.50

M10

Part No.	Description	Qty	Price
B024025-100	M10 x 35mm	100	£29.36
B356301-50	M10 x 40mm	50	£14.60
B024027-50	M10 x 50mm	50	£21.24
B356336-50	M10 x 60mm	50	£23.90
B116003-100	M10 x 80mm	100	£52.76

M12

Part No.	Description	Qty	Price
B517887-50	M12 x 30mm	50	£20.91
B517895-50	M12 x 40mm	50	£25.06
B116005-50	M12 x 45mm	50	£29.78
B517909-50	M12 x 50mm	50	£30.94

Serrated Flange Bolts



- DIN6921
- Grade 8.8
- Zinc

M5

Part No.	Description	Qty	Price
216100	M5 x 10mm	500	£19.55
216102	M5 x 12mm		

M10

Part No.	Description	Qty	Price
216138	M10 x 16mm	200	£32.78
216140	M10 x 20mm	200	£36.94
216144	M10 x 25mm	200	£37.25
216148	M10 x 30mm	200	£41.34
216152	M10 x 35mm	100	£21.32
216154	M10 x 40mm	100	£23.29
216156	M10 x 45mm	100	£24.52
216158	M10 x 50mm	100	£27.51

M12

Part No.	Description	Qty	Price
216160	M12 x 30mm	100	£29.28
216162	M12 x 35mm	100	£32.36
216164	M12 x 40mm	100	£32.43
216166	M12 x 45mm	100	£37.09
216168	M12 x 50mm	100	£42.64

Socket Button Head Screws



- Self Colour
- Grade 10.9
- DIN ISO 7380
- Metric thread

M5

Part No.	Description	Qty	Price
401199	M5 x 20mm	200	£6.27
401197	M5 x 30mm	500	£31.36

M6

Part No.	Description	Qty	Price
246675	M6 x 10mm	200	£4.80
401204	M6 x 20mm	200	£8.21
246680	M6 x 25mm	200	£11.95

M8

Part No.	Description	Qty	Price
401267	M8 x 10mm	200	£9.14
401255	M8 x 12 mm	200	£11.10
400006	M8 x 16mm	200	£17.49
400007	M8 x 20mm	200	£17.84
400008	M8 x 25mm	200	£20.36
401262	M8 x 30mm	200	£21.91
401266	M8 x 40mm	200	£43.64

M10

Part No.	Description	Qty	Price
401275	M10 x 30mm	200	£51.99

Pan Head Slotted Machine Screws BZP



- DIN84
- Quality: 4.8
- BZP

M3

Part No.	Description	Qty	Price
B072230-200	M3 x 6mm	200	£3.87
B072257-200	M3 x 10mm	200	£2.45
B072265-200	M3 x 12mm	200	£3.60
B072273-200	M3 x 16mm	200	£4.40
B072281-200	M3 x 20mm	200	£3.26
B072290-200	M3 x 25mm	200	£3.44
B072303-200	M3 x 30mm	200	£4.04
B072311-200	M3 x 35mm	200	£4.58
B072320-200	M3 x 40mm	200	£4.96
B0933667-200	M3 x 50mm	200	£5.42

M4

Part No.	Description	Qty	Price
B072397-200	M4 x 6mm	200	£3.38
B072400-200	M4 x 8mm	200	£3.44
B072419-200	M4 x 10mm	200	£3.52
B072427-200	M4 x 12mm	200	£3.56
B072435-200	M4 x 16mm	200	£3.85
B072451-200	M4 x 20mm	200	£4.20
B072460-200	M4 x 25mm	200	£5.06
B072478-200	M4 x 30mm	200	£5.63
B072486-200	M4 x 35mm	200	£6.22
B072494-200	M4 x 40mm	200	£7.57
B072621-200	M4 x 50mm	200	£8.27
B310565-200	M4 x 60mm	200	£7.73

M5

Part No.	Description	Qty	Price
B072559-200	M5 x 6mm	200	£4.77
B072567-200	M5 x 8mm	200	£4.88
B072575-200	M5 x 10mm	200	£5.23
B072583-200	M5 x 12mm	200	£5.23
B072591-200	M5 x 16mm	200	£5.75
B072613-200	M5 x 20mm	200	£7.05
B072630-200	M5 x 25mm	200	£7.80
B072648-200	M5 x 30mm	200	£7.90
B072656-200	M5 x 35mm	200	£8.67
B072664-200	M5 x 40mm	200	£10.10
B072672-200	M5 x 45mm	200	£10.99

M5

Part No.	Description	Qty	Price
B072680-200	M5 x 50mm	200	£11.30
B072702-200	M5 x 60mm	200	£12.30
B310581-200	M5 x 70mm	200	£15.73
B310549-200	M5 x 80mm	200	£16.14

M6

Part No.	Description	Qty	Price
B072753-100	M6 x 10mm	100	£3.51
B072761-100	M6 x 12mm	100	£4.10
B072770-100	M6 x 16mm	100	£4.43
B072800-100	M6 x 20mm	100	£4.97
B072818-100	M6 x 25mm	100	£5.89
B072826-100	M6 x 30mm	100	£6.52
B072788-100	M6 x 35mm	100	£7.73
B072842-100	M6 x 40mm	100	£7.80
B072869-100	M6 x 50mm	100	£9.46
B072885-100	M6 x 60mm	100	£9.72
B310573-100	M6 x 70mm	100	£13.67
B507427-100	M6 x 80mm	100	£15.86
B022267-100	M6 x 100mm	100	£16.70

M8

Part No.	Description	Qty	Price
B072850-50	M8 x 16mm	50	£5.34
B072958-50	M8 x 20mm	50	£5.46
B072974-50	M8 x 30mm	50	£5.95
B072982-50	M8 x 40mm	50	£7.66
B072990-50	M8 x 50mm	50	£9.26
B073008-50	M8 x 60mm	50	£11.03

Pozi Machine Screws BZP



- DIN965
- Metric thread

M5

Part No.	Description	Qty	Price
302150	M5 x 16mm Pan	200	£8.76
302152	M5 x 20mm Pan	200	£6.74
302112	M5 x 20mm CSK	1000	£18.69
302154	M5 x 25mm Pan	200	£6.20
302114	M5 x 25mm CSK	200	£7.63
300240	M5 x 25mm CSK	1000	£25.40
302156	M5 x 30mm Pan	250	£10.85
302120	M5 x 40mm CSK	200	£8.05

M5 Cont.

Part No.	Description	Qty	Price
302124	M5 x 50mm CSK	25	£1.29
300245	M5 x 50mm CSK	100	£5.20

M6

Part No.	Description	Qty	Price
302162	M6 x 20mm Pan	250	£9.24
302128	M6 x 20mm CSK	200	£6.15
300249	M6 x 25mm CSK	250	£9.63
300251	M6 x 30mm CSK	500	£20.52
302166	M6 x 30mm Pan	200	£10.38
300253	M6 x 40mm CSK	250	£14.21
300254	M6 x 50 mm CSK	500	£32.84

M8

Part No.	Description	Qty	Price
300260	M8 x 30mm CSK	100	£10.07
300910	M8 x 50mm CSK	200	£25.78

Screwed Rod Mild Steel Self Colour



- DIN976
- Grade 4.8

Part No.	Description	Qty	Price
132210	M6 x 1m	1	£1.09
132214	M8 x 1m	1	£2.08
132218	M10 x 1m	1	£3.42
132222	M12 x 1m	1	£3.66
132226	M16 x 1m	1	£3.95
132238	M18 x 1m	1	£16.48
132230	M20 x 1m	1	£13.65
132232	M24 x 1m	1	£18.85

Screwed Rod A2



- A2 Stainless steel
- DIN976
- Colour code: green

1m

Part No.	Description	Qty	Price
B105724	M4 x 1m	1	£2.08
B080896	M5 x 1m	1	£3.04
B033073	M6 x 1m	1	£3.36
B023094	M8 x 1m	1	£3.80
B316997	M10 x 1m	1	£5.65

1m Cont.

Part No.	Description	Qty	Price
256590	M10 x 1m	5	£21.59
B319988	M12 x 1m	1	£7.91
256600	M12 x 1m	10	£79.77
B073180	M14 x 1m	1	£11.33
B066702	M16 x 1m	1	£15.18
B023769	M18 x 1m	1	£22.81
902568	M20 x 1m	1	£30.24
B257524	M24 x 1m	1	£38.32

Screwed Rod BZP 8.8



- DIN976
- Grade 8.8
- BZP

Part No.	Description	Qty	Price
B591378	M5 x 1m	1	£1.53
B916522	M6 x 1m	1	£2.57
132240	M6 x 1m	10	£2411
B916523	M8 x 1m	1	£2.90
132241	M8 x 1m	10	£27.23
B517950	M10 x 1m	1	£3.83
132242	M10 x 1m	10	£57.79
B517968	M12 x 1m	1	£5.92
132243	M12 x 1m	10	£55.44
B916526	M14 X 1m	1	£11.22
B517984	M16 x 1m	1	£11.58
B517992	M18 x 1m	1	£14.97
B518000	M20 x 1m	1	£16.47
B592625	M22 x 1m	1	£18.44
B591386	M24 x 1m	1	£19.80
B924768	M27 x 1m	1	£22.86
B536261	M30 x 1m	1	£22.87

Screwed Rod BZP 4.8



- DIN976
- Grade 4.8
- BZP

Part No.	Description	Qty	Price
132245	M4 x 1m	1	£1.53
132247	M5 x 1m	1	£1.58
132250	M6 x 1m	1	£1.75
B933541	M7 x 1m	1	£1.93
132252	M8 x 1m	1	£2.31
132254	M10 x 1m	1	£2.52
132256	M12 x 1m	1	£3.82
B181277	M14 x 1m	1	£4.10
132260	M16 x 1m	1	£5.70
B181293	M18 x 1m	1	£8.20
132269	M20 x 1m	1	£10.13
B124150	M22 x 1m	1	£11.58
132271	M24 x 1m	1	£12.72
B517925	M30 x 1m	1	£20.55
B592668	M8 x 2m	1	£4.39
B592676	M10 x 2m	1	£5.64
B106745	M12 x 2m	1	£6.86

Hex Nuts BZP



- DIN934
- Grade 8

Part No.	Description	Qty	Price
B004316-250	M2	250	£3.21
B004324-250	M3	250	£3.32
245434	M3	1000	£3.17</

Hex Nuts BZP Cont.

Part No.	Description	Qty	Price
B004391-100	M12	100	£7.25
245450	M12	200	£13.74
245452	M14	100	£10.62
245453	M16	100	£14.21
245454	M16	200	£19.76
B004421-50	M18	50	£11.20
245456	M18	100	£24.54
B004430-50	M20	50	£24.10
245458	M20	100	£27.22
B408980-25	M22	25	£10.13
B409006-25	M24	25	£22.77
B245463-50	M24	50	£18.26
B409022-10	M27	10	£10.84
B409049-10	M30	10	£13.59

Hex Nuts Stainless Steel



- Stainless Steel A2
- DIN934

Part No.	Description	Qty	Price
362224	M3	1000	£13.37
362244	M4	1000	£14.71
362254	M5	1000	£26.83
223340	M6	100	£4.85
362294	M8	500	£44.34
223342	M8	100	£10.43
362314	M10	200	£29.54
223344	M10	100	£15.36
362334	M12	200	£39.20
362343	M14	100	£26.75
362363	M16	100	£51.35
362383	M20	50	£36.54
362395	M24	25	£35.13

Coarse Steel Nuts Self Colour



- DIN934/267
- Grade 8
- Steel

Part No.	Description	Qty	Price
222210	M4	200	£1.45
222214	M5	200	£10.93

Coarse Steel Nuts Self Colour Cont.

Part No.	Description	Qty	Price
222218	M6	200	£2.72
222222	M8	200	£6.07
222226	M10	200	£9.32
222230	M12	200	£19.14
222234	M16	100	£15.41
222242	M24	25	£13.76

Metric Nyloc Nuts



- DIN985
- Grade 8
- BZP

Part No.	Description	Qty	Price
B006416-100	M3	100	£3.30
B006432-100	M5	100	£2.24
B006440-100	M6	100	£2.28
B006459-100	M7	100	£3.82
B006467-100	M8	100	£4.66
B006475-100	M10	100	£4.58
B006483-100	M12	100	£6.59
B006491-100	M14	100	£14.38
B006505-50	M16	50	£11.40
B006513-25	M18	25	£7.36
B006521-25	M20	25	£14.51
B006530-10	M22	10	£13.41
B006548-10	M24	10	£10.64
B408620-10	M27	10	£21.01
B408638-10	M30	10	£25.77

Coarse Nyloc Nuts

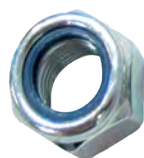

- DIN982
- Grade 8
- BZP
- Type P

Part No.	Description	Qty	Price
232215	M5	100	£1.83
232216	M5	200	£3.21
232218	M6	100	£2.62
232222	M6	200	£4.60
232226	M8	100	£4.17
232230	M8	200	£7.44
232238	M10	200	£15.42

Coarse Nyloc Nuts Cont.

Part No.	Description	Qty	Price
232234	M10	100	£7.98
232242	M12	100	£9.87
232244	M14	100	£15.60
232246	M16	50	£12.46
232250	M20	50	£21.55
232254	M24	25	£29.14
232253	M24	50	£55.48

Metric Fine Nyloc Nuts



- DIN985
- Grade 8
- BZP
- Fine thread

Part No.	Description	Qty	Price
B006270-100	M8 x 1	100	£6.40
B006289-100	M10 x 1	100	£12.50
B006360-100	M10 x 1.25	100	£12.80
B006394-100	M12 x 1	100	£16.93
B006378-100	M12 x 1.25	100	£17.00
B006300-50	M14 x 1.5	50	£14.54
B006319-50	M16 x 1.5	50	£16.82
B006327-25	M18 x 1.5	25	£14.01
B006335-25	M20 x 1.5	25	£17.17
B006343-10	M22 x 1.5	10	£15.38
B006351-10	M24 x 1.5	10	£16.63

Serrated Flange Hex Nuts



- DIN6923
- Grade 8
- BZP

Part No.	Description	Qty	Price
522289	M4	1000	£17.00
VANHSN55	M5	200	£5.11
522290	M6	200	£11.75
522292	M8	100	£6.96
522295	M10	50	£8.61
VANHSN62	M12	100	£16.18
522296	M12	500	£50.48
VANHSN66	M16	25	£22.15

BZP Flat Washers Form A



- DIN125A
- Zinc plated

Part No.	Description	Qty	Price
B007412-250	M3	250	£1.77
B007420-250	M4	250	£1.80
245467	M4	500	£2.67
B007439-250	M5	250	£1.94
246000	M5	500	£2.34
245472	M5	1000	£6.82
245474	M6	1000	£10.40
246002	M8	500	£7.12
245478	M8	1000	£16.65
245482	M10	500	£11.03
246003	M10	250	£6.04
245486	M12	500	£18.30
246004	M12	200	£7.66
245483	M14	100	£7.51
246005	M14	200	£12.64
245488	M14	400	£20.55
245484	M16	100	£7.85
246006	M16	150	£8.76
245490	M16	300	£19.00
246009	M18	100	£12.08
245491	M20	100	£12.90
246008	M24	50	£15.85
245700	M30	50	£18.45

BZP H-Flat Washers Form A



- BS4320
- Mild steel

Part No.	Description	Qty	Price
473210	M4	500	£2.49
473212	M5	200	£1.39
473214	M6	1000	£7.58
473218	M8	500	£7.84
473222	M10	500	£17.49
473226	M12	400	£18.12
473230	M14	100	£5.85
473240	M20	100	£13.81
473242	M22	200	£33.91

Stainless Steel Flat Washers Form A



- DIN125A
- Stainless Steel A2

Part No.	Description	Qty	Price
384135	M4	200	£2.67
384144	M5	1000	£19.90
384298	M6	1000	£16.57
384299	M8	500	£16.84
473300	M10	500	£25.10
473305	M12	200	£15.33
384296	M16	200	£26.37
384297	M20	200	£33.65

BZP Flat Washers Form C

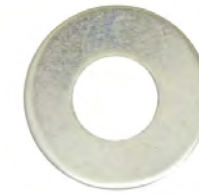

- BS4320
- Zinc

Part No.	Description	Qty	Price
246010	M6	500	£4.36
246015	M8	500	£9.43
246020	M10	250	£8.45
246025	M12	250	£14.28
246030	M14	100	£8.10
246035	M16	100	£10.89

Nylon Washers Form A



- DIN125
- White Nylon

Part No.	Description	Qty	Price
536010	M6	500	£10.10
536017	M8	500	£14.00

Metric BZP Repair Washers



- BS3410

Part No.	Description	Qty	Price
536380	M5 x 20	200	£5.97
536388	M6 x 20	100	£2.71
536389	M6 x 25	100	£3.66
536394	M8 x 20	200	£7.15
399036	M8 x 25	200	£6.64
536400	M10 x 25	200	£8.38
536401	M10 x 50	200	£23.29
536402	M12 x 38	50	£4.25
536403	M12 x 50	200	£32.68
536433	M14 x 28	100	£4.55

Imperial BZP Repair Washers



- Mild steel

Part No.	Description	Qty	Price
536250	3/16" x 3/4"	200	£6.40
536254	3/16" x 1"	200	£7.25
536261	1/4" x 3/4"	200	£6.34
536255	1/4" x 1"	200	£9.23
536256	1/4" x 1 1/2"	200	£19.86
536257	5/16 x 1"	200	£7.84
536269	5/16" x 1 1/4"	100	£6.70
536258	5/16" x 1 1/2"	200	£14.64
536253	3/8" x 1"	200	£8.67
536225	3/8" x 1 1/4"	100	£7.93
536260	3/8" x 1 1/2"	200	£15.08

BZP Imperial Repair Washers



- Mild steel

Part No.	Description	Qty	Price
536222	3/16" x 1"	100	£3.44
536213	3/16" x 1 1/2"	200	£21.45
536223	1/4" x 1 1/4"	200	£10.09
536212	1/4" x 2"	200	£29.43
536214	5/16" x 1"	200	£6.57
536218	5/16" x 1 1/2"	200	£13.54
536219	5/16" x 2"	200	£22.28
536226	3/8" x 1 1/2"	100	£7.84
536262	3/8" x 2"	100	£14.20
536233	1/2" x 1.5/8"	100	£29.37

Stainless Steel Repair Washers



- A2 Stainless Steel

Part No.	Description	Qty	Price
387883	M5 x 25	100	£11.89
387886	M6 x 25	200	£15.73
399013	M8 x 25	200	£16.09
387893	M8 x 30	200	£23.22
387895	M10 x 30	100	£16.47
387903	M12 x 35	200	£25.91

1240pc Flat & Repair Washers



£84.70

Part No. 750797

BZP Spring Washers Type B



- Square section spring washers

Part No.	Description	Qty	Price
245590	M5	500	£2.34
245492	M5	1000	£5.45
245494	M6	1000	£10.68
245592	M6	500	£7.32
245496	M8	1000	£11.30
245596	M10	250	£7.92
245479	M10	1000	£25.77
245500	M12	500	£25.64
245599	M12	250	£9.91
245602	M14	100	£10.09
245605	M16	100	£9.42
245503	M16	250	£19.17

HD Spring Washers Type B BZP



- BS4464
- Rec section

Part No.	Description	Qty	Price
475214	M6	1000	£12.41
475218	M8	1000	£28.45
475226	M12	250	£13.41
475230	M16	100	£14.67

1275pc 5-26mm DIN7603 Fibre Washers



£76.64

Part No. 168928

Copper Sealing Rings



- DIN7603
- Form A
- Temperature Resistant up to 300°C

Part No.	Description	Qty	Price
531-100	M4 x 8 x 1mm	100	£4.06
540-100	M5 x 9 x 1mm	100	£4.24
558-100	M6 x 10 x 1mm	100	£4.48
566-100	M6 x 12 x 1mm	100	£4.92
574-100	M8 x 12 x 1mm	100	£5.02
582-100	M8 x 14 x 1mm	100	£5.46
590-100	M8 x 16 x 1mm	100	£10.13
809-100	M10 x 14 x 1mm	100	£6.38
817-100	M10 x 16 x 1mm	100	£7.00
604-100	M12 x 16 x 1.5mm	100	£7.78
B000833-100	M12 x 18 x 1.5mm	100	£9.85
612-100	M14 x 18 x 1.5mm	100	£9.92
B000620-100	M14 x 20 x 1.5mm	100	£11.04
109911-100	M14 x 21 x 2mm	100	£20.44
639-100	M14 x 22 x 1.5mm	100	£11.94
891773-100	M15 x 21 x 1.5mm	100	£23.40
647-50	M16 x 20 x 1.5mm	50	£5.13
825-50	M16 x 22 x 1.5mm	50	£6.64
655-50	M16 x 24 x 1.5mm	50	£8.90
663-50	M18 x 22 x 1.5mm	50	£9.14
671-50	M18 x 24 x 1.5mm	50	£9.27
680-50	M20 x 24 x 1.5mm	50	£9.36
698-50	M20 x 26 x 1.5mm	50	£9.41
165822-50	M21 x 28 x 2mm	50	£13.64
701-50	M22 x 27 x 1.5mm	50	£6.93
710-50	M22 x 29 x 1.5mm	50	£8.18
B728-50	M24 x 29 x 1.5mm	50	£11.90
728-50	M24 x 29 x 2mm	50	£11.03
736-50	M24 x 32 x 2mm	50	£15.18
744-50	M26 x 32 x 2mm	50	£15.90
752-50	M26 x 34 x 2mm	50	£17.48
760-50	M28 x 34 x 2mm	50	£18.26
779-50	M28 x 36 x 2mm	50	£20.09
787-50	M30 x 36 x 2mm	50	£20.91
795-50	M32 x 38 x 2mm	50	£21.00
841-50	M33 x 39 x 2mm	50	£21.52
850-50	M35 x 41 x 2mm	50	£22.13

Fibre Washers



- DIN7603
- Form A
- Temperature Resistant up to 90°C

Part No.	Description	Qty	Price
1422-100	5 x 9 x 1mm	100	£3.22
1449-100	6 x 10 x 1mm	100	£3.21
1457-100	6 x 12 x 1mm	100	£3.40
1473-100	8 x 12 x 1mm	100	£3.44
1643-100	8 x 14 x 1mm	100	£4.10
1490-100	10 x 16 x 1mm	100	£4.16
1538-100	14 x 18 x 1.5mm	100	£5.24
1546-100	14 x 20 x 1.5mm	100	£5.61
1503-100	12 x 16 x 1.5mm	100	£4.32
1511-100	12 x 18 x 1.5mm	100	£4.59
1520-100	12 x 20 x 1.5mm	100	£6.33
1589-100	16 x 22 x 1.5mm	100	£6.52
1597-100	18 x 22 x 1.5mm	100	£4.36
1619-50	22 x 27 x 1.5mm	50	£4.14

Dowty Washer Sealing Rings



- DIN7603
- Yellow zinc plated
- Temperature resistant -30 to 120°C

Part No.	Description	Qty	Price
B765147-50	M6	50	£6.59
B778150-50	M8	50	£7.10
B778168-50	M10	50	£7.32
B106400-50	M12	50	£7.57
B106401-50	M14	50	£8.23
B936773-50	M16	50	£8.59
B106404-50	M18	50	£10.79
B106405-50	M20	50	£12.00
B778141-50	M22	50	£15.61
134306	M22	25	£12.37
B778176-50	M24	50	£15.68
134307	M24	25	£16.68

Nord-lock Retaining Washers



- Wedge locking washer

Part No.	Description	Qty	Price
B044405-100	M5	100	£59.70
B044406-100	M6	100	£60.46
B044408-100	M8	100	£60.84
B044396-50	M10	50	£36.93
B044397-50	M12	50	£56.34
B044398-25	M14	25	£39.56
B044399-25	M16	25	£43.84
B058558-100	M18	100	£203.24
B044400-10	M20	10	£21.11
B058559-100	M22	100	£299.96
B044401-10	M24	10	£45.31

Imperial O-Rings



- Resistant to petrol, oil, grease, hot water, steam, compressed air and weak acids
- Temperature resistant from -10 to +120°C
- Nitrile (NBR 70)

Part No.	Description	Qty	Price
B001970-10	1 7/16 x 3.53mm	10	£3.16
B001899-25	3/4 x 3.53mm	25	£3.58
B001821-50	3/8 x 2.62mm	50	£3.66
B001880-25	3/4 x 2.62mm	25	£3.07
B001902-25	13/16 x 3.53mm	25	£3.88
B001929-25	1 x 3.53mm	25	£4.16
B001813-50	3/8 x 1.78mm	50	£3.74
B001864-50	5/8 x 2.62mm	50	£4.48
B001872-25	11/16 x 2.62mm	25	£3.03
B001910-25	15/16 x 3.53mm	25	£4.00
B001988-10	1 1/2 x 5.34mm	10	£4.08
B001767-50	5/32 x 1.78mm	50	£4.18
B001775-50	3/16 x 1.78mm	50	£2.55
B001783-50	7/32 x 1.78mm	50	£3.06
B001791-50	1/4 x 1.78mm	50	£3.06
B001805-50	5/16 x 1.78mm	50	£3.12

Imperial O-Rings Cont.

Part No.	Description	Qty	Price
B001830-50	7/16 x 2.62mm	50	£3.21
B001848-50	1/2 x 2.62mm	50	£4.16
B001856-50	9/16 x 2.62mm	50	£4.35
B001937-25	1 1/6 x 3.53mm	25	£3.83
B001945-25	1 1/8 x 3.53mm	25	£4.06
B001953-25	1 1/4 x 3.53mm	25	£4.39
B001961-10	1 3/8 x 3.53mm	10	£3.42
B001996-10	1 5/8 x 5.34mm	10	£4.08

Metric O-Rings



- Resistant to petrol, oil, grease, hot water, steam, compressed air and weak acids
- Temperature resistant from -10 to +120°C
- Nitrile (NBR 70)

Part No.	Description	Qty	Price
122051-50	3.0 x 2mm	50	£1.90
122054-50	6.0 x 2mm	50	£2.24
122055-50	7.0 x 2mm	50	£2.01
122056-50	8.0 x 2mm	50	£3.32
122160-50	9.5 x 2.5mm	50	£2.98
122057-50	10.0 x 2.5mm	50	£2.72
122058-50	12.0 x 2.5mm	50	£2.98
122059-50	14.0 x 2.5mm	50	£3.14
122060-50	15.0 x 2.5mm	50	£3.26
122061-25	17.0 x 2.5mm	25	£3.43
123239-25	18 x 2mm	25	£3.54
122063-25	18.0 x 3mm	25	£3.61
122062-25	19.0 x 2mm	25	£3.64
122064-25	20.0 x 3mm	25	£3.73
122065-25	22.0 x 3mm	25	£3.94
122066-25	24.0 x 3mm	25	£4.08
122067-25	25.0 x 3mm	25	£4.17
122069-25	28.0 x 3mm	25	£4.33
122070-25	30 x 3mm	25	£4.69
122077-25	30 x 3.5mm	25	£4.54
122078-25	32 x 3.5mm	25	£5.17
122079-25	33 x 3.5mm	25	£5.76
122080-10	35 x 3.5mm	10	£2.31
122072-10	36 x 3mm	10	£5.38
122073-10	38 x 3mm	10	£2.57
122074-10	40 x 3mm	10	£6.6
122075-10	42 x 3mm	10	£2.87

330pc Metric O-Rings



£62.50

Part No. 54478

566pc Imperial O-Rings



£40.43

Part No. B235350

345pc Blanking Plugs

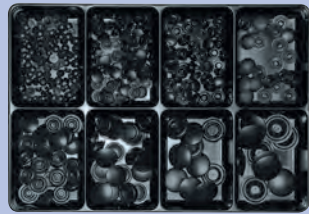

£58.85

Part No. B168966

Surface Screw Cup Washers



• Nickel plated

Part No.	Description	Qty	Price
434000	No6	200	£6.53
434010	No8	200	£8.73
434020	No10	200	£11.04
434022	No12	500	£40.26

Internal Shake Proof Washers



• A2 stainless steel

Part No.	Description	Qty	Price
450319	M6	500	£11.57
450324	M8	1000	£20.23

Black Nylon Nut Protectors



Part No.	Description	Qty	Price
536069	M5	100	£7.55
536070	M6	100	£5.87
536071	M8	100	£8.05
536072	M10	100	£12.89
536073	M12	50	£10.04
536074	M16	50	£11.06

White Nylon Nut Protectors



Part No.	Description	Qty	Price
536381	M5	100	£7.56
536382	M6	100	£7.63
536383	M8	100	£7.91
536384	M10	100	£9.71
536386	M12	50	£14.06
536385	M16	50	£18.51

Black Self Tapping Screws



• DIN968
• Pan head
• Black zinc finish

Part No.	Description	Qty	Price
173380-100	3.5 x 16mm	100	£3.18
173398-100	3.5 x 19mm	100	£2.41

Black Self Tapping Screws Cont.

Part No.	Description	Qty	Price
173401-100	3.5 x 22mm	100	£2.45
173428-100	3.9 x 13mm	100	£2.48
173444-100	3.9 x 16mm	100	£2.52
173452-100	3.9 x 19mm	100	£4.15
173479-100	3.9 x 22mm	100	£2.81
173410-100	3.9 x 9.5mm	100	£2.97
173517-100	4.2 x 13mm	100	£2.99
173525-100	4.2 x 16mm	100	£3.21
173533-100	4.2 x 19mm	100	£3.51
173541-100	4.2 x 22mm	100	£4.52
632554-100	4.2 x 25mm	100	£3.97
173550-100	4.8 x 13mm	100	£3.04
173576-100	4.8 x 16mm	100	£3.34
173614-100	4.8 x 19mm	100	£3.43
173622-100	4.8 x 22mm	100	£4.24
632562-100	4.8 x 25mm	100	£4.62

Pan Head Self Tapping Screws



• Electro-plated version
• ISO7049, formerly DIN7981

PH1

Part No.	Description	Qty	Price
87696-250	2.9 x 6.5mm PH1	250	£2.07
87700-250	2.9 x 9.5mm PH1	250	£2.39
87718-250	2.9 x 13mm PH1	250	£2.48
87726-250	2.9 x 16mm PH1	250	£2.81
87750-250	3.5 x 6.5mm PH1	250	£3.11
87769-250	3.5 x 9.5mm PH1	250	£3.38
B535557-250	3.5 x 13mm PH1	250	£3.58
87785-250	3.5 x 16mm PH1	250	£4.63
B535559-250	3.5 x 19mm PH1	250	£5.38
B537017-250	3.5 x 25mm PH1	250	£6.39

PH2

Part No.	Description	Qty	Price
88307-250	3.9 x 6.5mm PH2	250	£4.76
87840-250	3.9 x 9.5mm PH2	250	£3.70
87858-250	3.9 x 13mm PH2	250	£3.72
87866-250	3.9 x 16mm PH2	250	£4.22
87874-250	3.9 x 19mm PH2	250	£4.70
87890-250	3.9 x 25mm PH2	250	£5.29

PH2 Cont.

Part No.	Description	Qty	Price
87904-100	3.9 x 32mm PH2	100	£2.90
87920-250	4.2 x 9.5mm PH2	250	£3.89
B535570-250	4.2 x 13mm PH2	250	£4.22
87947-250	4.2 x 16mm PH2	250	£4.58
B535572-250	4.2 x 19mm PH2	250	£4.63
87963-250	4.2 x 22mm PH2	250	£5.59
B535574-250	4.2 x 25mm PH2	250	£6.20
87980-100	4.2 x 32mm PH2	100	£2.98
B535578-100	4.2 x 38mm PH2	100	£3.17
88005-100	4.2 x 45mm PH2	100	£4.06
70016-100	4.2 x 50mm PH2	100	£4.69
88013-250	4.8 x 9.5mm PH2	250	£4.38
B537028-250	4.8 x 13mm PH2	250	£5.62
B535583-250	4.8 x 19mm PH2	250	£6.02
88056-100	4.8 x 22mm PH2	100	£3.27
B535584-100	4.8 x 25mm PH2	100	£3.80
B537035-100	4.8 x 32mm PH2	100	£4.50
B535588-100	4.8 x 38mm PH2	100	£4.83
88099-100	4.8 x 45mm PH2	100	£4.92
B535590-100	4.8 x 50mm PH2	100	£5.09

PH3

Part No.	Description	Qty	Price
88129-100	5.5 x 16mm PH3	100	£3.93
B537037-100	5.5 x 19mm PH3	100	£3.93
88145-100	5.5 x 22mm PH3	100	£4.90
B537040-100	5.5 x 25mm PH3	100	£4.62
B537042-100	5.5 x 32mm PH3	100	£4.83
B537043-100	5.5 x 38mm PH3	100	£5.20
B537046-100	5.5 x 50mm PH3	100	£6.48
88200-100	6.3 x 13mm PH3	100	£4.65
B535597-100	6.3 x 16mm PH3	100	£5.01
B535608-100	6.3 x 19mm PH3	100	£5.30
88234-100	6.3 x 22mm PH3	100	£6.04
88242-100	6.3 x 25mm PH3	100	£6.24
88250-100	6.3 x 32mm PH3	100	£7.36
B537056-100	6.3 x 38mm PH3	100	£7.82
88285-100	6.3 x 50mm PH3	100	£11.01

Raised CSK Self Tapping Screws



• Electro-plated version
• DIN7983 (ISO 7051)

Part No.	Description	Qty	Price
B088978-250	2.9 x 9.5mm PH1	250	£2.26
B088986-250	2.9 x 13mm PH1	250	£2.54
B089036-250	3.5 x 13mm PH2	250	£3.05
B089044-250	3.5 x 16mm PH2	250	£3.38
B089052-250	3.5 x 19mm PH2	250	£3.81
B089079-250	3.5 x 25mm PH2	250	£4.33
B089192-250	4.2 x 13mm PH2	250	£4.38
B089206-250	4.2 x 16mm PH2	250	£4.42
B089214-250	4.2 x 19mm PH2	250	£4.92
B089222-250	4.2 x 22mm PH2	250	£5.08
B089281-100	4.8 x 13mm PH2	100	£2.74
B089290-100	4.8 x 16mm PH2	100	£4.24
B089303-250	4.8 x 19mm PH2	250	£6.51
B089311-100	4.8 x 22mm PH2	100	£2.95
B089443-100	5.5 x 45mm PH3	100	£6.14

900pc Black Flange Self Drilling Screws

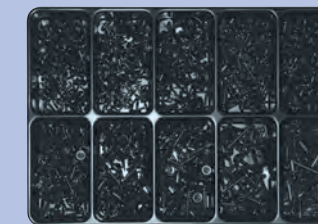

£66.72

Part No. 168922

Socket Flange Dome Screws



• Self Coloured
• GR10.9

Part No.	Description	Qty	Price
401010	M6 x 20mm	200	£14.38
401004	M8 x 16mm	200	£20.58
401000	M8 x 20mm	200	£31.01
402102	M8 x 25mm	200	£36.55

Pozi CSK ST Screws AB-Zinc



• Zinc-plated
• Type C (AB)
• Case hardened steel

Part No.	Description	Qty	Price
B535547-250	6 x 1/2 (3.5 x 13)	250	£3.22
B535548-250	6 x 3/4 (3.5 x 19)	250	£3.83
B537062-250	6 x 1 (3.5 x 25)	250	£3.46
535514	6 x 1.1/2 (3.5 x 38)	500	£7.71
537064	6 x 1.1/4 (3.5 x 32)	500	£7.67
B535516-250	8 x 1/2 (4.2 x 13)	250	£4.35
537019	8 x 1/2 (4.2 x 13)	200	£3.28
B535554-250	8 x 3/4 (4.2 x 19)	250	£4.44
B535555-250	8 x 1 (4.2 x 25)	250	£4.64
B535556-100	8 x 1.1/4 (4.2 x 32)	100	£2.42
B535558-100	8 x 1.1/2 (4.2 x 38)	100	£5.46
B535593-100	8 x 2 (4.2 x 50)	100	£4.15
537029	8 x 2 (4.2 x 50)	200	£6.23
B537082-100	10 x 3/4 (4.8 x 19)	100	£2.45
537080	10 x 1/2 (4.8 x 13)	500	£8.20
B535565-100	10 x 1 (4.8 x 25)	100	£2.78
B535567-100	10 x 1.1/4 (4.8 x 32)	100	£6.00
B535568-100	10 x 1.1/2 (4.8 x 38)	100	£4.00
B535569-100	10 x 2 (4.8 x 50)	100	£4.44
537089	12 x 3/4 (5.5 x 19)	1000	£24.23
B537090-100	12 x 1 (5.5 x 25)	100	£4.98
537092	12 x 1.1/2 (5.5 x 38)	500	£22.56
B537091-100	12 x 1.1/4 (5.5 x 32)	100	£4.52
B535575-100	12 x 2 (5.5 x 50)	100	£6.12
537094	14 x 1 (6.3 x 25)	250	£11.72
537039	14 x 1.1/2 (6.3 x 38)	250	£13.86
535585	14 x 1.1/2 (6.3 x 38)	1000	£49.17
B537098-100	14 x 2 (6.3 x 50)	100	£6.75

Pozi Flange Self Tapping Screws Black



Part No.	Description	Qty	Price
VANHTK6/6	6 x 3/4 (3.5 x 19)	200	£3.90
535650	6 x 1/2 (3.5 x 13)	1000	£29.06
488440	8 x 3/4 (4.2 x 19)	1000	£25.16
VANHTK8/6	8 x 3/4 (4.2 x 19)	200	£3.83
535654	8 x 1/2 (4.2 x 13)	1000	£18.46
VANHTK8/4	8 x 1/2 (4.2 x 13)	200	£3.50
535656	8 x 1 (4.2 x 25)	1000	£20.47

Pozi Flange Self Tapping Screws Black Cont.

Part No.	Description	Qty	Price
VANHTK8/8	8 x 1 (4.2 x 25)	200	£5.35
VANHTK10/6	10 x 3/4 (4.8 x 19)	200	£5.58
535658	10 x 1/2 (4.8 x 13)	1000	£21.30
VANHTK10/8	10 x 1 (4.8 x 25)	200	£10.20

Pozi RS ST Screws AB-Zinc



- Zinc
- Pozi raised

Part No.	Description	Qty	Price
535942	6 x 1/2 (3.5 x 13)	1000	£11.64
535950	8 x 1/2 (4.2 x 13)	200	£2.52
535954	8 x 3/4 (4.2 x 19)	1000	£15.09
535956	8 x 1 (4.2 x 25)	200	£5.94
535960	8 x 1.1/2 (4.2 x 38)	200	£6.20

CSK Head Taptite Screws



Part No.	Description	Qty	Price
488747	M6 x 25mm Pozi BZP	500	£41.24
488740	M6 x 40mm Pozi BZP	200	£20.67
488749	M6 x 40mm Pozi BZP	250	£33.12
488741	M6 x 50mm Pozi BZP	250	£39.83
488750	1/4 UNC x 1"	200	£36.55
488754	1/4 UNC x 1.1/2	200	£46.63

Parker Floor Screws



Part No.	Description	Qty	Price
B170536-250	6.3 x 60 TX30 BZP	250	£19.00
B170537-250	6.3 x 70 TX30 BZP	250	£25.07

Hex HD Parker Floor Screws



Part No.	Description	Qty	Price
VANHHD10/8	4.8 x 25	200	£9.51
VANHHD12/8	5.5 x 25	200	£10.08
VANHHD14/8	6.3 x 25	200	£17.11
VANHHD14/12	6.3 x 38	200	£21.45

Cladfast Tek Screw HS



Part No.	Description	Qty	Price
832914	5.5 x 24mm	500	£35.93
832916	5.5 x 38mm	500	£44.07
832918	5.5 x 51mm	250	£28.15
832920	5.5 x 67mm	250	£33.10
832922	5.5 x 100mm	200	£39.83

Cladfast Tek Screw HS with 16mm EPDM Washer



Part No.	Description	Qty	Price
832900	5.5 x 24mm	500	£42.93
832902	5.5 x 32mm	500	£54.20
832904	5.5 x 38mm	250	£34.77
832906	5.5 x 51mm	250	£35.70
832908	5.5 x 67mm	250	£43.10
832910	5.5 x 76mm	250	£44.22
832912	5.5 x 100mm	200	£38.14

Cladfast Tek Screw LS with 16mm EPDM Washer



Part No.	Description	Qty	Price
832924	5.5 x 20mm	500	£35.62
832928	5.5 x 32mm	500	£41.20
832930	5.5 x 38mm	500	£69.99

Cladfast Tek Screw LS with 16mm EPDM Washer Cont.

Part No.	Description	Qty	Price
832932	5.5 x 50mm	250	£29.46
832934	5.5 x 57mm	250	£35.45
832936	5.5 x 70mm	250	£42.22
832938	5.5 x 82mm	250	£45.21
832940	5.5 x 98mm	200	£46.95

Phillips Black Flange Self Drilling Screw



Part No.	Description	Qty	Price
158271-500	3.9 x 13mm	500	£8.59
158272-500	3.9 x 16mm	500	£11.24
158273-500	3.9 x 19mm	500	£12.07
158274-500	3.9 x 25mm	500	£15.33
832820-500	4.8 x 16mm	500	£15.62
832839-500	4.8 x 19mm	500	£16.95
832847-500	4.8 x 22mm	500	£18.79
832855-500	4.8 x 25mm	500	£20.85
158276-500	4.8 x 32mm	500	£27.15
158277-500	4.8 x 45mm	500	£30.81

Hex Head Acme Screws



- Zinc Plated

Part No.	Description	Qty	Price
FORF56757	No8 x 3/4	100	£5.87
101016	No10 x 3/4	100	£9.03
101012	No12 x 3/4	100	£8.33
101014	No14 x 3/4	100	£13.11

Hex Head Parker Screws



Part No.	Description	Qty	Price
B079995-100	4.8 x 19mm	100	£12.02
B273600-100	5.6 x 13mm	100	£12.50
B079952-100	5.6 x 19mm	100	£12.98
B079413-100	6.3 x 16mm	100	£13.44
B079405-100	6.3 x 19mm	100	£14.59
B081604-100	6.5 x 16mm	100	£18.37

Speed Fasteners



Part No.	Description	Qty	Price
B078875-100	15 x 11 D3.9	100	£6.01
B078921-100	15 x 12 D4.8	100	£6.01
B078840-100	16 x 11 D3.5	100	£7.83
B078883-100	16 x 11 D4.2	100	£7.83
B078832-100	16.5 x 11 D3.5	100	£8.54
B078948-100	20 x 13 D5.6	100	£11.75
B078913-100	24 x 16 D4.8	100	£15.42
B078964-100	25 x 16 D6.5	100	£19.07

Speed Fasteners Assortments

325pc Speed Fasteners



£74.06

Part No. B169003

276pc Speed Fastener & Hex Screws



£81.47

Part No. B169001

Number Plate Self Tapper - Flip Type



Part No.	Description	Qty	Price
544204	No8 x 3/4in White	100	£6.67
544206	No8 x 3/4in Yellow	100	£6.67
544208	No8 x 3/4in Black	100	£6.67
544209	No8 x 3/4in Blue	100	£6.67

Number Plate Screws



Part No.	Description	Qty	Price
VANNP16	No10 x 18mm White	100	£18.30
VANNP17	No10 x 18mm Yellow	100	£18.30
VANNP18	No10 x 18mm Black	100	£18.30
VANNP20	No.10 x 18mm Blue	100	£18.30

Number Plate Bolts & Nuts



Part No.	Description	Qty	Price
544214	25mm Yellow	100	£5.68
544210	25mm Black	100	£5.68
544218	25mm White	100	£5.68

R-Clips



Part No.	Description	Qty	Price
B931279-10	M2.5 x 42mm	10	£3.49
B523801-10	M3 x 48mm	10	£5.09
B523810-10	M4 x 64mm	10	£5.65
B523828-10	M5 x 80mm	10	£7.50
B523836-10	M6.5 x 97mm	10	£13.83
B931115-10	M8 x 125mm	10	£18.93
B931116-10	M9 x 150mm	10	£25.61

R-Clips BZP



Part No.	Description	Qty	Price
438260	3mm Wire	100	£7.91
438261	4mm Wire	50	£8.15
438262	5mm Wire	50	£13.76
438263	6mm Wire	25	£11.14

Linch Pins



Part No.	Description	Qty	Price
438268	1/4	10	£3.09
438269	5/16	10	£3.23
438271	7/16	10	£5.17

Zinc Plated Split Pins



- DIN94

Part No.	Description	Qty	Price
2003-250	1 x 20mm	250	£3.03
2011-250	1.6 x 20mm	250	£4.93
2020-250	1.6 x 32mm	250	£3.07
938632-250	2 x 16mm	250	£7.89
2046-250	2 x 25mm	250	£4.69
2054-250	2 x 32mm	250	£4.94
2062-250	2 x 40mm	250	£6.48
2070-250	2.5 x 32mm	250	£6.55
2089-100	2.5 x 40mm	100	£3.58
2097-100	3.2 x 32mm	100	£4.13
2100-100	3.2 x 40mm	100	£3.91
2119-100	3.2 x 50mm	100	£4.43
2127-100	3.2 x 63mm	100	£5.24
2135-100	3.5 x 40mm	100	£5.37
938577-100	4 x 25mm	100	£5.62
2143-100	4 x 32mm	100	£5.65
2151-100	4 x 40mm	100	£5.68
2160-100	4 x 50mm	100	£5.82
2178-100	4 x 63mm	100	£7.44
108590-100	5 x 40mm	100	£8.75
2186-50	5 x 50mm	50	£6.88
2208-50	6.3 x 63mm	50	£7.00
2224-50	6.3 x 80mm	50	£8.07
2240-50	8 x 80mm	50	£22.00
2259-50	8 x 100mm	50	£21.91
2267-50	10 x 100mm	50	£30.93

Mild Steel Split Pins



• DIN94

Part No.	Description	Qty	Price
532246	5/32 x 2	250	£15.50
532250	3/16 x 2	250	£16.55

Cotter Pins



• DIN1481

Part No.	Description	Qty	Price
35-100	3 x 20mm	100	£4.06
51-100	3 x 30mm	100	£6.78
78-100	3 x 40mm	100	£7.82
108-100	4 x 20mm	100	£8.28
132-100	4 x 30mm	100	£8.58
159-100	4 x 40mm	100	£8.90
167-100	4 x 50mm	100	£10.86
183-100	5 x 20mm	100	£11.91
213-100	5 x 30mm	100	£13.24
248-100	5 x 40mm	100	£13.42
264-100	5 x 50mm	100	£13.97
272-100	5 x 60mm	100	£14.06
310-100	6 x 30mm	100	£14.55
337-50	6 x 40mm	50	£7.33
353-50	6 x 50mm	50	£8.02
361-50	6 x 60mm	50	£8.18
388-50	6 x 80mm	50	£11.7
400-50	8 x 40mm	50	£9.83
434-25	8 x 60mm	25	£6.94
450-25	8 x 70mm	25	£17.33
469-25	8 x 80mm	25	£12.00
477-25	10 x 40mm	25	£9.01
485-10	10 x 50mm	10	£3.82
507-25	10 x 60mm	25	£10.64
515-10	10 x 70mm	10	£5.34
523-10	10 x 80mm	10	£5.65
408310-10	12 x 80mm	10	£9.42

Standard Dome Head Pop Rivets



Part No.	Description	Qty	Price
780010	3.2 x 12mm	200	£2.52
780016	3.2 x 18mm	500	£17.46
780025	4.0 x 20mm	1000	£19.65
780020	4.8 x 12mm	500	£10.40
780026	4.8 x 16mm	500	£14.16
780030	4.8 x 16mm	1000	£24.90
780033	4.8 x 18mm	200	£5.97
780032	4.8 x 18mm	1000	£42.08
780034	4.8 x 20mm	200	£6.03
780042	4.8 x 20mm	1000	£26.04
780208	4.8 x 25mm	500	£44.43
780060	4.8 x 35mm	100	£8.55
780044	6.4 x 20mm	500	£29.39
780043	6.4 x 20mm	200	£11.75
780050	6.4 x 25mm	500	£32.93
780046	6.4 x 25mm	200	£13.19

Large Flange Head Pop Rivets



Part No.	Description	Qty	Price
780136	4.8 x 12	200	£7.84
780140	4.8 x 12	500	£15.90
780148	4.8 x 20	200	£11.14
780152	4.8 x 20	500	£20.59
01641-02621	4.8 x 20	500	£30.89
780160	4.8 x 25	200	£11.44
780164	4.8 x 25	500	£21.62
01641-02631	4.8 x 27	500	£34.31

Multi-Fast CSK Head Pop Rivets



Part No.	Description	Qty	Price
780328	4.8 x 16	500	£18.48
780336	4.8 x 18	500	£18.21

Multi-Fast Dome Head Pop Rivets



Part No.	Description	Qty	Price
780256	3.2 x 12	200	£3.23
780260	3.2 x 12	500	£7.96
780268	4.0 x 10	200	£3.82
780267	4.0 x 12.7	1000	£20.89
780282	4.0 x 14	500	£16.45
780286	4.8 x 10	200	£4.77
780290	4.8 x 15	200	£6.88
780294	4.8 x 15	500	£14.85
780298	4.8 x 15	1000	£29.71
780296	4.8 x 18	500	£16.02
780306	4.8 x 25	200	£8.94
780310	4.8 x 25	500	£19.73
780314	4.8 x 25	1000	£37.19

Multi-Fast Large Flange Pop Rivets



Part No.	Description	Qty	Price
780359	4.8 x 18	500	£22.08
780370	4.8 x 25	200	£9.52
780374	4.8 x 25	500	£23.83

Standard CSK Head Pop Rivets



Part No.	Description	Qty	Price
780085	3.2 x 10	500	£7.88
780094	4.0 x 12	500	£21.32
780107	4.8 x 16	1000	£27.53
780108	4.8 x 20	200	£8.67
780112	4.8 x 20	500	£22.31
780120	4.8 x 25	1000	£40.89

Aluminium Dome Head Rivets



Part No.	Description	Qty	Price
780019	4.8 x 12mm	200	£5.48
780038	4.8 x 20mm	500	£13.40

Low Profile Dome Head ALU Pop Rivets



Part No.	Description	Qty	Price
01661-02414	3.2 x 14	500	£23.57
01661-02516	4.0 x 16	500	£21.18
01661-02613	4.8 x 14	500	£14.38
01661-02619	4.8 x 18.7	500	£16.01
01661-02621	4.8 x 20	500	£39.01
01661-02631	4.8 x 27	500	£29.91

Peel Type Pop Rivets



Part No.	Description	Qty	Price
780396	4.8 x 18	500	£23.72
780400	4.8 x 20	500	£26.64
780405	4.8 x 25	500	£32.44
780430	4.8 x 40	500	£49.40
780410	4.8 x 25	1000	£54.82

Monobolts



Part No.	Description	Qty	Price
280832	6.4 x 23	100	£26.24
280806	6.4 x 23	200	£39.44
280808	6.4 x 23	1000	£194.13
02761-02821	6.4 x 26	250	£89.12
280840	6.4 x 32	100	£31.69
399012	6.4 x 32	250	£68.81

BZP Ball Joint Socket



• DIN71802

Part No.	Description	Qty	Price
B117512-5	M5 x 10	5	£13.78
B198358-5	M6 x 12	5	£15.76
B198366-5	M8 x 16	5	£17.41
B198374-5	M10 x 20	5	£18.77

Nutserts



Part No.	Description	Qty	Price
280899	4mm	50	£6.28
280898	5mm	50	£6.60
280900	6mm	50	£6.74
280902	8mm	50	£9.26

Large Flange Nutserts (Knurled)



Part No.	Description	Qty	Price
280918	M6	200	£23.40
280920	M8	200	£37.43

Galvanised Steel Nutserts



Part No.	Description	Qty	Price
B143711-100	M4 x 10mm	100	£9.30
B120003-100	M4 x 12.5mm	100	£10.91
B143713-100	M5 x 11.5mm	100	£11.08
B120004-100	M5 x 13.5mm	100	£11.25
B143714-100	M6 x 14mm	100	£11.77
B120005-100	M6 x 15.5mm	100	£12.42
B119937-100	M6 x 18.5mm	100	£13.12
B161113-100	M8 x 15.5mm	100	£16.37

Galvanised Steel Large Flange Nutserts



Part No.	Description	Qty	Price
B119923-100	M4 x 11mm	100	£11.24
B119925-100	M5 x 13mm	100	£11.70
B119926-100	M5 x 16mm	100	£12.05
B119933-100	M6 x 16mm	100	£17.85
B119946-100	M8 x 17.5mm	100	£18.85
B119948-100	M8 x 20mm	100	£21.81
B119958-100	M10 x 19mm	100	£22.56

Blind Ratchet Rivet Nut Tool

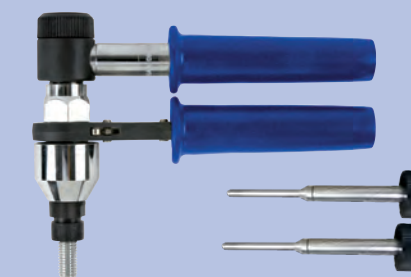

- For processing blind rivet nuts M5 to M12 and blind rivet bolts M5 to M8
- Minimum effort due to built-in ratchet function
- Fast and clean processing around large blind rivet nuts in heavily accessible places
- Saves time when changing threaded mandrel and threaded sleeve by a special fast change system

£197.02

Part No. B024813

Pozi Csk ZY Chipboard Screws Fully Threaded

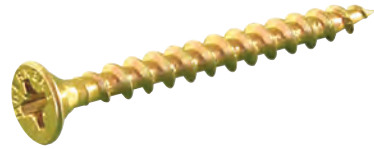

Part No.	Description	Qty	Price
B086648-1000	3.5 x 15mm	1000	£6.83
B086650-1000	3.5 x 17mm	1000	£7.67
B086651-1000	3.5 x 20mm	1000	£8.67
B086652-1000	3.5 x 25mm	1000	£9.33
B086653-1000	3.5 x 30mm	1000	£11.33
B086654-1000	3.5 x 35mm	1000	£13.33
B086655-1000	3.5 x 40mm	1000	£13.94
B086657-500	3.5 x 50mm	500	£8.00
B086663-1000	4 x 25mm	1000	£9.67
B086664-1000	4 x 30mm	1000	£11.00
B086665-500	4 x 35mm	500	£6.34
B086666-500	4 x 40mm	500	£7.33
B086667-500	4 x 45mm	500	£8.16
B086668-500	4 x 50mm	500	£9.00
B086670-400	4 x 60mm	400	£8.67
B086680-400	4.5 x 50mm	400	£8.54
B086682-300	4.5 x 60mm	300	£7.80
B086689-500	5 x 40mm	500	£10.66

Pozi Csk ZY Chipboard Screws Part Threaded



Part No.	Description	Qty	Price
B086962-300	4 x 70mm	300	£7.40
B086971-200	4.5 x 70mm	200	£6.00
B086691-300	5 x 50mm	300	£8.20
B086693-200	5 x 60mm	200	£6.19
B086694-200	5 x 70mm	200	£7.13
B086982-200	5 x 80mm	200	£8.60
B086983-150	5 x 90mm	150	£7.45
B086984-150	5 x 100mm	150	£8.29
B086992-100	6 x 100mm	100	£7.70
B086994-100	6 x 120mm	100	£10.73
B086997-100	6 x 150mm	100	£16.06

Solo Panel Screws (Optare)



Part No.	Description	Qty	Price
438300	Solo Panel Fastener Screw	1	£3.47
438302	Solo Panel Screw	1	£1.60

60mm Male Floor Trap Fastener ZP



- Zinc plated pressed steel
- ACME thread
- 66mm long

£8.48

Part No. 732306

Wire Rope Grips

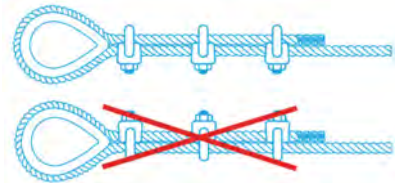

- Steel wire fastening, detachable cable end connections, if only minor requirements are placed on it
- Electrolytically galvanized
- Steel shackle with metric thread
- Malleable cast iron clamp base

Part No.	Description	Qty	Price
B020303-25	M4	25	£4.97
B020311-25	M5	25	£5.67
B020320-25	M5	25	£7.38
B020338-25	M6	25	£9.63
B020346-25	M8	25	£13.98
B020354-25	M8	25	£14.87
B020362-25	M10	25	£25.74
B020370-10	M10	10	£11.79
B020389-10	M12	10	£15.53
B020400-5	M14	5	£14.43

Thru Locking Pin Half Round Keep



Part No.	Description	Qty	Price
810690	6.3 x 50mm	50	£61.72
810700	8 x 57mm	50	£64.03
810710	10 x 57mm	50	£70.59
810720	11 x 90mm	50	£100.89

Flammables Storage Cabinet 1095 x 460 x 1655mm



- Sturdy metal construction with yellow powder coated finish
- Two doors fitted with a 3-point key lock with recessed handle, supplied with two keys
- Two adjustable lipped shelves
- Features two 2" BSP ventilation ports with caps that are equipped with a magnetic backing for convenient storage near the ports
- Four adjustable feet allow the cabinet to be set level on uneven ground
- For the safe storage of flammables, pesticides, paint and ink
- Supplied with a pack of appropriate warning labels
- This item is heavy, extra assistance must be provided at the delivery point to help its safe delivery

£999.95

Part No. FSC10

Floor Stand for FSC04



- 460 x 460 x 580mm (W x D x H)

£189.95

Part No. FSC04ST

Flammables Storage Cabinet 900 x 460 x 1800mm

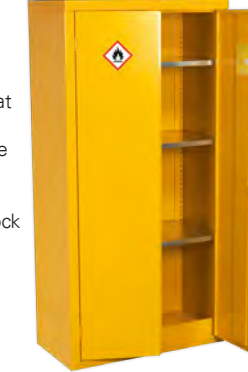

- Sturdy metal construction with yellow powder coat
- Supplied with a pack of appropriate warning labels
- Two door, fitted with 2-point key lock and supplied with two keys
- Features three adjustable, lipped shelves and liquid-tight base to retain spills
- 155mm Raised, leak-proof door sill

£759.15

Part No. FSC03

Hazardous Substance Cabinet 900 x 460 x 900mm



- Sturdy metal construction with yellow powder coat
- Supplied with a pack of appropriate warning labels
- Two door, fitted with 2-point key lock and supplied with two keys
- Features an adjustable, lipped shelf and liquid-tight base to retain spills
- Optional floor stand available, order Part No. FSC05ST

£540.75

Part No. FSC05

Floor Stand for FSC05



- 900 x 460 x 445mm (W x D x H)

£199.45

Part No. FSC05ST

Hazardous Substance Cabinet 460 x 460 x 900mm



- Sturdy metal construction with yellow powder coat
- Supplied with a pack of appropriate warning labels
- Single door, fitted with 2-point key lock and supplied with two keys
- Features an adjustable, lipped shelf and liquid-tight base to retain spills
- Smaller compact design for limited space
- Optional floor stand available, order Part No. FSC04ST

£381.05

Part No. FSC04

Flammables Storage Cabinet 350 x 300 x 705mm



- Sturdy metal construction with yellow powder coat
- Supplied with a pack of appropriate warning labels
- Single door, fitted with 2-point key lock and supplied with two keys
- Features an adjustable, lipped shelf and liquid-tight base to retain spills
- Smaller compact design for limited space
- Optional floor stand available, Part No. FSC06ST

£317.95

Part No. FSC06

Floor Stand for FSC06



- 350 x 300 x 580mm (W x D x H)

£169.95

Part No. SFC06ST

Antiluce Fasteners

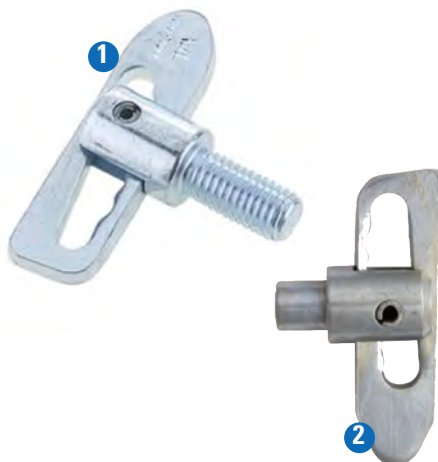

Part No.	Description	Qty	Price
438242	M8 x 20mm	1	£2.67
438238	M12 x 25mm	1	£2.22
438240	M12 x 33mm	1	£2.71
438244	1/2" Round Shank	10	£24.25



The BERA Module racks offer the ability to store small products which are required for daily work in an orderly and efficient manner

- The modules can be assembled to meet individual customer requirements
- A minimum amount of floor space is required to create maximum storage
- Valuable items can also be stored in lockable drawers
- Clear layout with easy removal of goods while providing optimal inventory control

- ✓ Be-spoke Storage Solution
- ✓ Optimal Inventory Control
- ✓ Time Saving
- ✓ Adds Value
- ✓ Improves Efficiency
- ✓ Space Saving

SPEAK TO US ABOUT FREE RACKING!

Fastener Module (Top)



- Up to 25 stock locations
- 6 movable dividers (285 x 38mm) per shelf
- Maximum Shelf Load: 25kg
- Dimensions (H x B x D): 1000 x 542.5 x 364mm

£170.03

Part No. B94065

Chemicals Module (Top)



- 6 rows of aerosols per shelf
- 7 dividers (305 x 78mm) per shelf
- Maximum Shelf Load: 25kg
- Dimensions (H x B x D): 1000 x 542.5 x 364mm

£159.53

Part No. B94069

5 Drawer Module with Peg Panel (Top)



- 5x smaller drawers suitable for storing 10 BERA plastic inserts
- Perforated plate for quick and easy mounting
- Dimensions (H x B x D): 1000 x 542.5 x 364mm

£337.21

Part No. B94075

2 Drawer Module with 3 Shelves (Top)



- 3x shelves ideal for storing fasteners and small parts
- 2x plexiglass front drawers (14cm height - inner dimension)
- Dimensions (H x B x D): 1000 x 542.5 x 364mm

£439.80

Part No. B94073

BERA CLIG Blue Storage Bins



Part No.	Description	Qty	Price
B324353	101 x 96 x 113mm	1	£2.30
B303178	101 x 96 x 180mm	1	£3.26
B303186	127 x 143 x 229mm	1	£4.60

Hook for Peg Panel



£1.28

Part No. B265136

Compartment Plastic Inserts



Part No.	Description	Qty	Price
B7148	4 Compartment	1	£2.26
B278904	6 Compartment	1	£2.26
B24198	8 Compartment	1	£2.26
B912181	10 Compartment	1	£2.26
B234800	12 Compartment	1	£2.26
B232823	20 Compartment	1	£2.26

Threaded Rod Module



- 1m lengths & 55cm lengths are stored in the lower part and short lengths are stored in the storage tray
- Cannot be used with a module top as the rods store higher than the top of the module
- Dimensions (H x B x D): 1000 x 542.5 x 364mm

£131.08

Part No. B94094

Fastener Module (Base)



- Up to 25 stock locations
- 6 movable dividers (285 x 38mm per shelf)
- Maximum Shelf Load: 25kg
- Dimensions (H x W x D): 1000 x 542.5 x 364mm

£161.03

Part No. B94063

Chemicals Module (Base)



- 6 rows of aerosols per shelf
- 7 dividers (305 x 78mm) per shelf
- Maximum Shelf Load: 25kg
- Dimensions (H x B x D): 1000 x 542.5 x 364mm

£113.33

Part No. B94066

13 Drawer Module (Base)



- 12x smaller drawers suitable for storing 24 BERA plastic inserts
- 1x large drawer: 78mm (height - inside dimension)
- Secure as drawers can be locked

£666.02

Part No. B94074

5 Drawer Module with Shelf (Base)



- 5x drawers suitable for storing 10 BERA plastic inserts
- 1x shelf and universal base plate
- 6 dividers (285 x 38mm) per shelf
- Dimensions (H x B x D): 1000 x 542.5 x 364mm

£300.03

Part No. B94093

3 Bracket Dispenser (Abrasive Rolls)



£43.14

Part No. B100099

BERA® CLIC Cases

- Quick & easy organisation of tools etc.
- Cases can be connected together depending on individual needs with just one twist
- High stability
- Good protection against moisture and dust
- Ergonomic handle
- Label slot on the front of the case for easy identification of content



Part No.	Size	L x B x H	Qty	Price
B102544	Size 1	396 x 296 x 105mm	1	£26.13
B102545	Size 2	396 x 296 x 157.5mm	1	£34.60
B102546	Size 3	396 x 296 x 210mm	1	£41.01
B102547	Size 4	396 x 296 x 315mm	1	£54.21
B102548	Size 5	396 x 296 x 420mm	1	£61.66

49 x 98 x 71mm Yellow Insert



£0.53

Part No. B104094

98 x 98 x 71mm Blue Insert

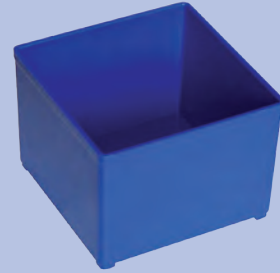

£0.85

Part No. B104115

98 x 147 x 71mm Green Insert

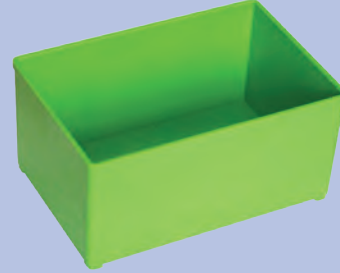

£1.38

Part No. B104088

49 x 245 x 71mm Orange Insert

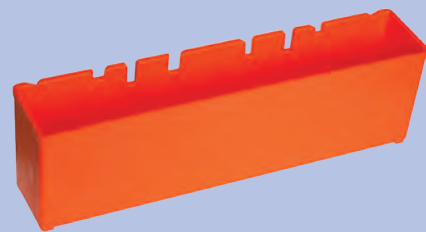

£1.54

Part No. B104124

49 x 49 x 71mm Red Insert



£0.42

Part No. B104116

17pc Compartment Set

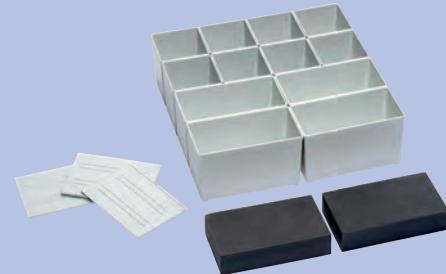

£32.02

Part No. B337800

Module Insert Tray

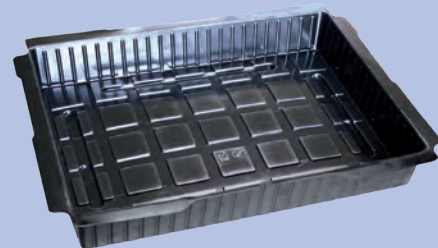

£3.39

Part No. B104125

Cover for Module Tray

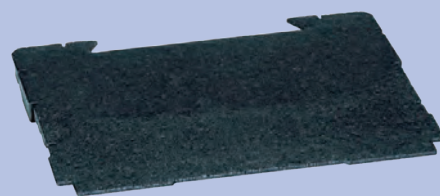

£3.45

Part No. B104062

8 in 1 Compartment Insert Tray



£3.28

Part No. B102574

Storage Rack with 93 Bins

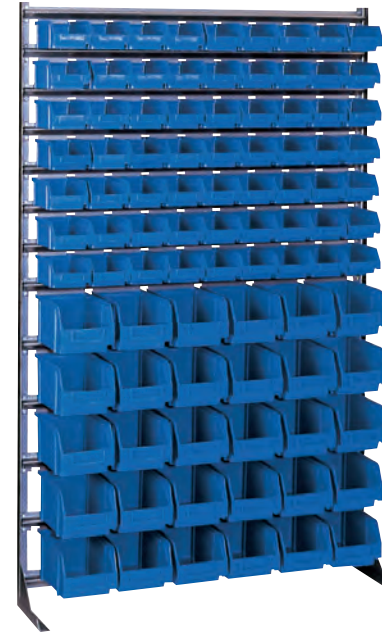

- Dimensions: 1020 x 1590mm (WxH)
- Stores up to 63 size 4 and 30 size 3 bins
- Supplied with fixing kit

£245.17

Part No. B510350

Blue Storage Bins

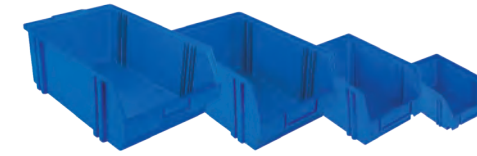

Part No.	Description	Qty	Price
B20033	Size 4 (73 x 165 x 98.5mm)	1	£1.00
B20026	Size 3 (125 x 143 x 223mm)	1	£2.64
B20013	Size 2 (153 x 210 x 348mm)	1	£6.60
B20005	Size 1 (183 x 306 x 473mm)	1	£15.60

Red Storage Bins



Part No.	Description	Qty	Price
710209	6.1/2 x 4 x 3" Size 2	2	£2.96
710216	9.1/2 x 6 x 5" Size 3	1	£3.19
710219	14 x 8 x 5" Size 4	1	£7.38
710228	14 x 8 x 7" Size 5	1	£7.91
710232	16.1/2 x 15 x 7" Size 6	1	£17.42

Wall Bracket For Storage Bins



- Suitable for storage bins (6x 9x sizes 3 and 4)
- Suitable for BERA system boxes (6x or 9x BERA BERA 3, 4 or 5)

£5.84

Part No. B310425

20mm Combination Padlock



£11.35

Part No. 310270

- Ideal for luggage, Toolboxes and Lockers
- 3 Wheel Combination

40mm Rust Proof Padlock c/w 2 Keys



£30.88

Part No. 310221

- Highly resistant against rust
- Stainless Steel

50mm Keyed-A-Like Brass Padlock



£10.37

Part No. 310239

- Hardened Steel Shackle
- 2 Keys

ONE KEY FITS ALL

Brass Padlocks c/w 3 Keys



Part No.	Description	Qty	Price
310208	25mm	1	£2.79
310214	30mm	1	£2.79
310220	40mm	1	£3.31
310222	50mm	1	£6.59



- For medium security applications

Part No.	Description	Qty	Price
310226	38mm Long Shackle	1	£4.71
310246	50mm Long Shackle	1	£8.76

Hasp and Staple



Part No.	Description	Qty	Price
1 777808	3" Light Duty	1	£2.33
2 777796	3.1/2"	1	£10.04

8pc Extra Long Ball-End Hex Key Set H/D (6-19mm)



- Contents: 6, 7, 8, 10, 12, 14, 17 & 19mm
- Supplied in a handy folding case

£45.83

Part No. B200785

9pc Extra Long Ball End Hex Key Set (1.5-10mm)



- Contents: 1.5, 2, 2.5, 3, 4, 5, 6, 8 & 10mm
- Extra long for deep & narrow spaces
- Allows work up to an angle of 30°
- Supplied in a handy folding case

£31.42

Part No. B200453

Extra Long Ball-End Hex Key Pins



- Made from Chrome Vanadium steel DIN / ISO
- Matt chrome finish
- Extra long for deep & narrow spaces
- Allows work up to an angle of 30°

Part No.	Description	Qty	Price
B200454	1.5 x 90mm	1	£0.75
B200455	2 x 100mm	1	£0.88
B200456	2.5 x 112mm	1	£1.10
B200457	3 x 126mm	1	£1.10
B200458	4 x 140mm	1	£1.71
B200459	5 x 160mm	1	£2.18
B200460	6 x 180mm	1	£2.71
B200452	7 x 190mm	1	£3.94
B200461	8 x 200mm	1	£4.71
B200462	10 x 224mm	1	£5.95
B200535	12 x 250mm	1	£6.56
B200536	14 x 282mm	1	£8.48
B200537	17 x 320mm	1	£18.10
B200494	19 x 360mm	1	£20.66

9pc Extra Long Magnetic Security TX Key Set (TX10 - TX50)



- Contents: TX10, TX15, TX20, TX25, TX27, TX30, TX40, TX45 & TX50
- Supplied in a handy folding case

£22.02

Part No. B200503

Extra Long Magnetic Security TX Key Pins



- Magnetic on long side
- Security pin on short side
- Chrome-plated, satined surface
- Good corrosion protection
- Made of high-quality vanadium steel
- Extra long for deep & narrow spaces

Part No.	Description	Qty	Price
B200504	TX10 x 93mm	1	£3.03
B200505	TX15 x 102mm	1	£3.03
B200506	TX20 x 115mm	1	£3.03
B200507	TX25 x 130mm	1	£3.25
B200508	TX27 x 145mm	1	£3.25
B200509	TX30 x 165mm	1	£3.25
B200510	TX40 x 187mm	1	£3.96
B200511	TX45 x 207mm	1	£3.96
B200512	TX50 x 233mm	1	£4.58

18pc Combination Security R-TX/Hex Key Set (1.5-10mm, RTX10-50)

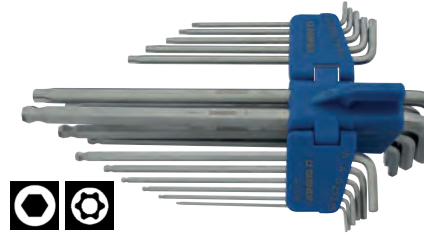

- Contents:
- Ball-End Hex Keys
 - 1.5, 2, 2.5, 3, 4, 5, 6, 8 & 10mm
 - Security Keys
 - TX10, TX15, TX20, TX25, TX27, TX30, TX40, TX45 & TX50

£45.60

Part No. B200789

9pc Extra Long Angle Torx Key Set (RTX10-50)



- Contents: R-TX10, R-TX15, R-TX20, R-TX25, R-TX27, R-TX30, R-TX40, R-TX45 & R-TX50
- Supplied in a handy folding case

£32.26

Part No. B200532

Extra Long R-TX Security Key Pins

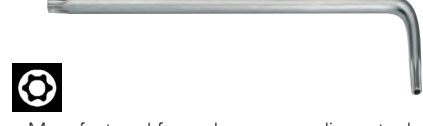

- Manufactured from chrome vanadium steel according to DIN / ISO
- Matte chrome surface finish
- Good fit in screw head due to chamfered search edge at key ends
- Extra long for deep & narrow spaces

Part No.	Description	Qty	Price
B200775	R-TX10 x 90mm	1	£3.16
B200776	R-TX15 x 100mm	1	£3.22
B200777	R-TX20 x 112mm	1	£3.43
B200779	R-TX25 x 126mm	1	£3.43
B200780	R-TX27 x 140mm	1	£3.55
B200781	R-TX30 x 160mm	1	£3.55
B200782	R-TX40 x 180mm	1	£4.42
B200783	R-TX45 x 200mm	1	£4.91
B200784	R-TX50 x 224mm	1	£5.25

9pc Super Extra Long Security R-TX Key Set (TX10-TX50)



- Contents: TX10, TX15, TX20, TX25, TX27, TX30, TX40, TX45 & TX50
- Supplied in a handy folding case

£37.22

Part No. B200513

Super Extra Long R-TX Security Key Pins



- Short sloping section with hole for screw with safety pin
- Super extra long for deep and narrow spaces
- Chrome-plated, satin-finished surface for good corrosion protection

Part No.	Description	Qty	Price
B200514	R-TX10 x 136mm	1	£3.95
B200515	R-TX15 x 151mm	1	£4.16
B200516	R-TX20 x 171mm	1	£4.27
B200517	R-TX25 x 192mm	1	£4.27
B200518	R-TX27 x 215mm	1	£4.44
B200519	R-TX30 x 245mm	1	£4.44
B200520	R-TX40 x 277mm	1	£5.52
B200521	R-TX45 x 308mm	1	£6.13
B200522	R-TX50 x 344mm	1	£6.57

9pc Super Extra Long Ball-End Magnetic Hex Key Set (1.5-10mm)



- Contents: 1.5, 2, 2.5, 3, 4, 5, 6, 8 & 10mm
- Supplied in a handy plastic case

£22.89

Part No. B200473

Super Extra Long Ball-End Hex Key Pins

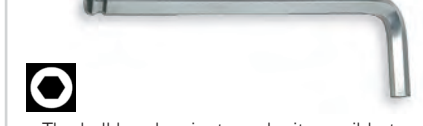

- The ball head variants make it possible to work at an angle of 30° to the face of the screw head
- Made from Chrome Vanadium steel DIN / ISO
- Matt chrome finish

Part No.	Description	Qty	Price
B200474	1.5 x 135mm	1	£1.58
B200475	2 x 150mm	1	£1.66
B200476	2.5 x 168mm	1	£2.33
B200477	3 x 189mm	1	£2.34
B200478	4 x 210mm	1	£2.43
B200479	5 x 240mm	1	£2.48
B200480	6 x 270mm	1	£3.08
B200481	8 x 300mm	1	£5.37
B200482	10 x 366mm	1	£6.77

9pc Short TX Key Set (TX10-TX50)



- Contents: TX10, TX15, TX20, TX25, TX27, TX30, TX40, TX45 & TX50
- Supplied in a handy plastic case

£9.71

Part No. B200483

Short TX Key Pins



- Precisely designed according to DIN / ISO
- Made from high quality vanadium steel
- Matt chrome-plated surface for good corrosion protection

Part No.	Description	Qty	Price
B200484	TX10 x 51mm	1	£2.02
B200485	TX15 x 54mm	1	£2.02
B200486	TX20 x 57mm	1	£2.64
B200487	TX25 x 60mm	1	£2.64
B200488	TX27 x 64mm	1	£2.73
B200489	TX30 x 70mm	1	£2.73
B200490	TX40 x 76mm	1	£3.39
B200491	TX45 x 82mm	1	£3.76
B200492	TX50 x 95mm	1	£4.04

We are
United Industrial Supplies

Your one stop supplier for workshop consumables, tools, chemicals and janitorial products

With over 10,000 products online we offer a vast range from a single source

Visit unitedindustrial.co.uk



7pc Extra Long RIBE Key Set (M4-M10)



- Contents: M4, M5, M6, M7, M8, M9, M10
- Supplied in a handy folding case

£21.11

Part No. B200523

Extra Long RIBE Keys



- Manufactured from Chrome Vanadium steel according to DIN / ISO
- Extra long for deep and narrow spaces
- Made from high quality vanadium steel
- Matt chrome surface finish for good corrosion protection

Part No.	Description	Qty	Price
B200524	M4	1	£1.96
B200525	M5	1	£2.51
B200526	M6	1	£3.14
B200527	M7	1	£3.95
B200528	M8	1	£5.46
B200529	M9	1	£6.28
B200530	M10	1	£6.86

9pc Extra Long Ball-End Magnetic Hex Key Set (1.5-10mm)

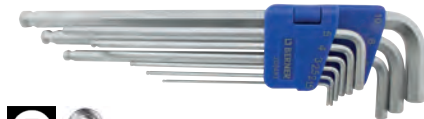

- Contents: 1.5, 2, 2.5, 3, 4, 5, 6, 8 & 10mm
- Supplied in a handy plastic case
- Magnetic ball head from Ø3

£19.81

Part No. B200463

Long Magnetic Ball-End Hex Key



- The ball head allows work up to an angle of 30° to the face of the screw head
- Made from Chrome Vanadium steel DIN / ISO
- Matt chrome surface finish for good corrosion protection
- Magnetic ball head from Ø3

Part No.	Description	Qty	Price
B200454	1.5mm	1	£0.75
B200455	2mm	1	£0.88
B200456	2.5mm	1	£1.10
B200467	3mm	1	£1.50
B200468	4mm	1	£1.77
B200469	5mm	1	£2.29
B200470	6mm	1	£2.85
B200471	8mm	1	£4.97
B200472	10mm	1	£6.24

9pc Hex Key Set (1.5-10mm)



- Contents: 1.5, 2, 2.5, 3, 4, 5, 6, 8 & 10mm
- Supplied in a handy plastic case

£6.19

Part No. B200437

Hex Keys



- Made from Chrome Vanadium steel DIN / ISO
- Matt chrome surface finish for good corrosion protection

Part No.	Description	Qty	Price
B200438	1.5mm	1	£0.59
B200439	2mm	1	£0.61
B200440	2.5mm	1	£0.70
B200441	3mm	1	£0.90
B200442	4mm	1	£1.47
B200443	5mm	1	£1.50
B200444	6mm	1	£2.42
B200445	8mm	1	£3.06
B200446	9mm	1	£5.01
B200447	10mm	1	£5.01
B200448	12mm	1	£7.07
B200449	14mm	1	£7.88
B200450	17mm	1	£14.39
B200451	19mm	1	£22.17

8pc Folding Hex Key Set (1.5 - 8mm)



- Contents: 1.5, 2, 2.5, 3, 4, 5, 6 & 8mm
- Chrome plated, satin finished for good corrosion protection

£11.25

Part No. B122189

5pc Folding Ball-End Hex Key Set (4-10mm)



- Contents: 4, 5, 6, 8 & 10mm
- Ball head variants suitable for working at a maximum angle of 30°

£9.56

Part No. B123106

7pc Folding Key Set (TX10 - TX40)



- Contents: TX10, TX15, TX20, TX25, TX27, TX30 & TX40
- Black finish for good corrosion protection

£13.40

Part No. B122188

8pc T-Handle Metric Hex Key Set (2-10mm)

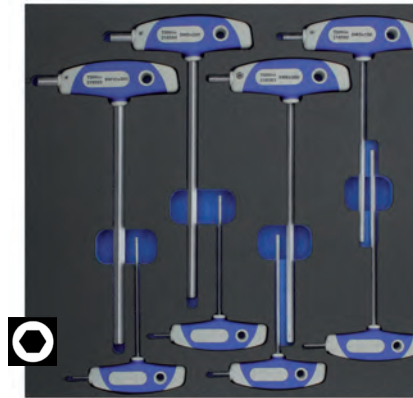

- Contents: 2, 2.5, 3, 4, 5, 6, 8 & 10mm
- Supplied in foam insert

£53.08

Part No. B240255

Hex T-Handles



- High power transmission
- High-quality hexagonal blade made of chrome vanadium-molybdenum steel, matt chrome plated for good protection against corrosion
- The handle is highly resistant to vehicle-specific liquids, such as petrol, diesel, (mineral) oils and brake fluid

Part No.	Description	Qty	Price
B218578	2mm	1	£3.23
B218579	2.5mm	1	£3.23
B218580	3mm	1	£3.32
B218581	4mm	1	£3.47
B218582	5mm	1	£4.22
B001212	6mm	1	£4.47
B218584	8mm	1	£5.02
B218585	10mm	1	£7.46

8pc TX T-Handle Set (TX10-50)



- Contents: TX10, TX15, TX20, TX25, TX27, TX30, TX40 & TX50
- Supplied in foam insert

£60.94

Part No. B240256

TX T-Handles



- High quality round shaft for full and direct transmission
- Handle is well-resistant to vehicle-specific liquids, such as petrol, diesel, (mineral) oils and brake fluid
- Chrome-plated, satin-finished shaft for optimal protection against corrosion
- Black point bronzed head for exact fit

Part No.	Description	Qty	Price
B001216	TX10 x 100mm	1	£4.11
B218587	TX10 x 200mm	1	£4.93
B001217	TX15 x 100mm	1	£4.11
B218589	TX15 x 200mm	1	£4.93
B218590	TX20 x 100mm	1	£4.61
B218591	TX20 x 200mm	1	£5.38
B218592	TX25 x 100mm	1	£6.34
B218593	TX25 x 200mm	1	£4.94
B218594	TX27 x 150mm	1	£4.38
B218595	TX27 x 200mm	1	£5.02
B218596	TX30 x 150mm	1	£4.82
B218597	TX30 x 200mm	1	£5.34
B001225	TX40 x 150mm	1	£4.90
B218599	TX45 x 150mm	1	£6.02
B001227	TX50 x 150mm	1	£6.16

T-Handle Socket Wrenches



Part No.	Description	Qty	Price
B218572	6 x 230mm	1	£6.39
B218573	8 x 230mm	1	£6.51
B218574	10 x 230mm	1	£10.91
B218575	10 x 350mm	1	£9.39
B218576	12 x 230mm	1	£7.91
B218577	13 x 230mm	1	£11.44

Ball-End HEX T-Handles



- Chrome plated for good protection against corrosion
- The ball head makes it possible to work at an angle of up to 30° to the screw head
- The handle is highly resistant to vehicle-specific liquids, such as petrol, diesel, (mineral) oils and brake fluid

Part No.	Description	Qty	Price
B218601	4mm	1	£4.43
B218602	5mm	1	£4.93
B218603	6mm	1	£5.04
B218604	8mm	1	£5.65
B218605	10mm	1	£8.62

Self Adjusting Open-Ended Ratchet Spanner



- Ratchet mechanism in the head, making it easier and faster to operate
- Can also be used on damaged bolts and nuts
- Suitable for metric and imperial wrench size
- Self-adjustable to the dimensions of the screw head

Part No.	Description	Qty	Price
B336251	10 x 135mm	1	£16.18
B336252	13 x 155mm	1	£17.90
B336253	16 x 186mm	1	£21.78
B336254	19 x 213mm	1	£37.69

DuoGear Combination Ratchet Spanner



- Unique ratchet wrench with ratchet function on the open side
- Ideal for pipe fittings in tight spaces
- Ring side exactly 72 teeth
- Turn the key to change the direction of rotation
- Sturdy and durable ratchet for high tightening torques

Part No.	Description	Qty	Price
B412837	8mm x 8mm	1	£11.59
B412838	9mm x 9mm	1	£11.71
B412839	10mm x 10mm	1	£11.83
B412840	11mm x 11mm	1	£14.66
B412841	12mm x 12mm	1	£14.96
B412842	13mm x 13mm	1	£15.40
B412843	14mm x 14mm	1	£15.60
B412844	15mm x 15mm	1	£16.39
B412845	16mm x 16mm	1	£18.50
B412846	17mm x 17mm	1	£18.76
B412847	18mm x 18mm	1	£19.97
B412848	19mm x 19mm	1	£20.73

Reversible Combination Ratchet Spanners with Switch



- Handy lever switch for easy change of direction
- Fine-toothed with 5° ratchet angle
- 12-point ratchet drive for narrow spaces
- 15° angle on the ratchet drive
- Made from chrome vanadium

Part No.	Description	Qty	Price
B371170	6 x 140mm	1	£7.60
B371171	7 x 140mm	1	£7.63
B371172	8 x 140mm	1	£7.72
B371173	9 x 150mm	1	£8.31
B371174	10 x 160mm	1	£8.38
B371175	11 x 165mm	1	£8.60
B371176	12 x 170mm	1	£9.01
B371177	13 x 178mm	1	£9.52
B371178	14 x 190mm	1	£10.10
B371180	15 x 200mm	1	£10.48
B371181	16 x 208mm	1	£11.24
B371182	17 x 225mm	1	£11.72

Part No.	Description	Qty	Price
B371183	18 x 237mm	1	£12.80
B371184	19 x 248mm	1	£13.60
B371185	21 x 288mm	1	£21.13
B371186	22 x 288mm	1	£19.11
B371187	24 x 322mm	1	£22.02
B371188	27 x 359mm	1	£33.37
B371189	30 x 425mm	1	£45.79
B371190	32 x 425mm	1	£44.24
B371191	34 x 485mm	1	£68.01
B371192	36 x 485mm	1	£68.01
B371193	38 x 485mm	1	£68.01

Combi Ratchet Spanner Cap Stop with switch



- Capstop for use on long threaded rods with nuts so spanner stops on the nut
- Fine-toothed with 5° ratchet angle
- Easy change of direction
- Handy lever switch
- 12-point ratchet drive for narrow spaces
- Extremely durable

Part No.	Description	Qty	Price
B371227	6 x 140mm	1	£11.40
B371228	7 x 140mm	1	£11.40
B371229	8 x 140mm	1	£11.48
B371230	9 x 150mm	1	£11.48
B371231	10 x 160mm	1	£12.13
B371232	11 x 165mm	1	£12.52
B371233	12 x 170mm	1	£13.62
B371234	13 x 178mm	1	£13.82
B371235	14 x 190mm	1	£14.82
B371236	15 x 200mm	1	£15.33
B371237	16 x 208mm	1	£16.32
B371238	17 x 225mm	1	£17.18
B371239	18 x 237mm	1	£18.69
B371240	19 x 248mm	1	£19.51

8 in 2 Ratchet Ring Spanner Set



Sizes:

- 8x10mm
- 12x13mm
- 14x17mm
- 18x19 mm
- Only 2 spanners to cover 8 sizes:
- Can be used in confined spaces due to short stroke (72 teeth - 5°)
- Switchable left/right

£31.61

Part No. B371226

Combination Spanner



- Non-slip surface - better grip with greasy hands
- Chrome-Vanadium steel
- Twelve point ring head is set at a 15° angle
- Ring and shaft are matt chrome, satin finish
- DIN 3113

Part No.	Description	Qty	Price
B104382	6 x 100mm	1	£1.50
B104383	7 x 110mm	1	£1.50
B104384	8 x 120mm	1	£1.83
B104385	9 x 130mm	1	£1.72
B104386	10 x 140mm	1	£2.01
B104387	11 x 150mm	1	£2.05
B104389	12 x 160mm	1	£2.37
B104390	13 x 170mm	1	£2.37
B104391	14 x 180mm	1	£2.86
B104392	15 x 190mm	1	£2.86
B104393	16 x 200mm	1	£3.54
B104394	17 x 210mm	1	£3.54
B104395	18 x 220mm	1	£3.83
B104397	19 x 232mm	1	£3.83

Part No.	Description	Qty	Price
B104398	20 x 240mm	1	£4.64
B104399	21 x 250mm	1	£4.68
B104401	22 x 260mm	1	£5.48
B104402	23 x 270mm	1	£5.48
B104403	24 x 280mm	1	£6.69
B104404	25 x 340mm	1	£6.66
B104405	26 x 300mm	1	£7.72
B104406	27 x 310mm	1	£7.72
B104407	28 x 320mm	1	£8.02
B104408	29 x 330mm	1	£8.57
B104409	30 x 340mm	1	£8.82
B104410	32 x 370mm	1	£9.28
B104411	34 x 400mm	1	£10.92

Long Combination Spanner



- Non-slip surface - better grip with greasy hands
- Chrome-Vanadium steel
- Twelve point ring head is set at a 15° angle
- Ring and shaft are matt chrome, satin finish
- DIN 3113

Part No.	Description	Qty	Price
B104437	8 x 130mm	1	£1.60
B104438	9 x 141mm	1	£1.62
B104439	10 x 154mm	1	£1.83
B104440	11 x 166mm	1	£1.83
B104441	12 x 178mm	1	£2.18
B104443	13 x 190mm	1	£2.34
B104444	14 x 203mm	1	£2.57
B104445	15 x 215mm	1	£2.75
B104446	16 x 227mm	1	£2.88
B104447	17 x 239mm	1	£3.06
B104448	18 x 250mm	1	£3.29
B104449	19 x 263mm	1	£3.58

Part No.	Description	Qty	Price
B104451	21 x 288mm	1	£4.11
B104452	22 x 300mm	1	£4.25
B104454	24 x 330mm	1	£5.29
B104455	27 x 360mm	1	£8.17
B104456	30 x 410mm	1	£9.53
B104457	32 x 420mm	1	£10.16
B104458	34 x 430mm	1	£11.23
B316512	36 x 440mm	1	£12.95
B123501	41 x 480mm	1	£13.61
B082747	46 x 505mm	1	£22.21
B082748	50 x 540mm	1	£28.33

Double Open End Spanners



- Non-slip surface - better grip with greasy hands
- Made from Chrome Vanadium steel
- Head angle: 15°
- Shaft: matt chrome, satin finish
- DIN 3113

Part No.	Description	Qty	Price
B039306	5 x 5.5mm	1	£1.13
B104358	6 x 7mm	1	£1.20
B104359	8 x 9mm	1	£1.40
B104360	10 x 11mm	1	£1.51
B104362	10 x 13mm	1	£1.54
B104363	12 x 13mm	1	£2.12
B104364	13 x 17mm	1	£2.26
B104365	14 x 15mm	1	£2.40
B104366	16 x 17mm	1	£2.62
B104367	16 x 18mm	1	£2.89
B104369	17 x 19mm	1	£2.97
B104371	18 x 19mm	1	£3.25
B104372	19 x 22mm	1	£4.62
B104373	20 x 22mm	1	£4.82
B104374	21 x 23mm	1	£4.68
B104375	22 x 24mm	1	£5.36
B104376	24 x 27mm	1	£5.59
B104377	25 x 28mm	1	£5.95
B104378	26 x 28mm	1	£6.60
B104379	27 x 29mm	1	£6.96
B104380	30 x 32mm	1	£6.96
B104381	34 x 36mm	1	£13.28
B208000	36 x 41mm	1	£15.03
B183892	41 x 46mm	1	£29.34
B183891	46 x 50mm	1	£34.19

Double Offset Ring Spanners



- Non-slip surface - better grip with greasy hands
- Made from Chrome Vanadium steel
- 12 point Bi-Hex ring head
- Ring and shaft are matt chrome, satin finish
- DIN 838

Part No.	Description	Qty	Price
B104459	6 x 7mm	1	£2.38
B104460	8 x 9mm	1	£2.59
B104461	10 x 11mm	1	£2.93
B104462	12 x 13mm	1	£3.36
B104463	13 x 17mm	1	£4.50
B104464	14 x 15mm	1	£4.00
B104465	16 x 17mm	1	£4.63
B104466	17 x 19mm	1	£5.08
B104467	18 x 19mm	1	£5.63
B208639	19 x 22mm	1	£6.28
B104468	20 x 22mm	1	£6.38
B104470	21 x 23mm	1	£8.17
B104471	22 x 24mm	1	£9.59
B104472	24 x 26mm	1	£9.53
B104473	24 x 27mm	1	£10.11
B104475	25 x 28mm	1	£10.60
B104476	26 x 28mm	1	£10.60
B104478	27 x 29mm	1	£11.72
B104479	27 x 30mm	1	£11.72
B104480	27 x 32mm	1	£12.36
B104481	30 x 32mm	1	£12.75
B104482	30 x 34mm	1	£15.65
B104483	34 x 36mm	1	£15.48
B208671	36 x 41mm	1	£24.05
B184054	41 x 46mm	1	£48.33
B184056	46 x 50mm	1	£63.03

Adjustable Spanners



- DIN 3117
- Chrome-Vanadium Steel
- Precise parallel jaws for perfect grip
- 22° angled head
- Precise adjustment - metric precision guides

Part No.	Description	Qty	Price
B366361	13 Jaw x 115mm	1	£17.96
B366363	24 Jaw x 208mm	1	£23.40
B366364	34 Jaw x 259mm	1	£26.97
B366365	39 Jaw x 311mm	1	£42.58
B366367	43 Jaw x 386mm	1	£62.57
B366368	53 Jaw x 462mm	1	£91.14
B366369	62 Jaw x 612mm	1	£138.17

Flexi-head Combination Ratchet Spanners



- Made from Chrome Vanadium steel
- Matt chrome design
- 12 side with fine teeth (72 teeth)
- Ideal for the (dis)assembly of hard to reach fasteners

Part No.	Description	Qty	Price
B371205	6 x 140mm	1	£11.99
B371206	7 x 140mm	1	£12.31
B371207	8 x 140mm	1	£13.30
B371208	9 x 150mm	1	£14.83
B371209	10 x 160mm	1	£12.79
B371210	11 x 165mm	1	£15.70
B371211	12 x 172mm	1	£25.41
B371212	13 x 178mm	1	£13.96
B371213	14 x 190mm	1	£17.50
B371214	15 x 200mm	1	£17.67
B371215	16 x 208mm	1	£24.04
B371216	17 x 225mm	1	£16.23
B371217	18 x 237mm	1	£26.18
B169639	19 x 251mm	1	£26.18

Straight Combination Ratchet Spanner



- Straight ratchet ring wrench with fine teeth
- Ratchet angle of 5°, open end angle of 15°
- 12-point ring mount
- Chrome vanadium steel
- Matt chrome satin finish prevents glare and reflections

Part No.	Description	Qty	Price
B082903	6 x 126mm	1	£6.59
B082904	7 x 137mm	1	£6.59
B336363	8 x 140mm	1	£6.55
B336357	9 x 148mm	1	£6.82
B336353	10 x 160mm	1	£7.59
B336360	11 x 165mm	1	£7.51
B336355	12 x 170mm	1	£7.90
B336352	13 x 178mm	1	£9.13
B336358	14 x 190mm	1	£9.05
B336350	15 x 200mm	1	£9.90
B336356	16 x 205mm	1	£10.1
B336359	17 x 225mm	1	£10.71
B336361	18 x 236mm	1	£11.44
B336362	19 x 248mm	1	£12.87
B170377	21 x 274mm	1	£15.14
B170378	22 x 279mm	1	£16.64
B170379	24 x 310mm	1	£20.97
B170380	27 x 331mm	1	£34.01
B170381	30 x 389mm	1	£42.38
B170382	32 x 415mm	1	£52.24

Ring Slogging Spanners



Part No.	Description	Qty	Price
835000	21mm	1	£20.85
835002	24mm	1	£20.85
835004	27mm	1	£20.85
835006	30mm	1	£20.85
835008	32mm	1	£20.85
835010	36mm	1	£25.94
835012	50mm	1	£41.54

9pc Offset Double Ring Spanner Set

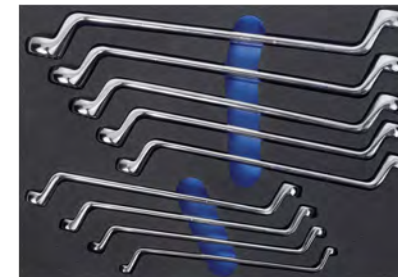

Set contains 1x of the following:
 • 6x7, 8x9, 10x11, 12x13, 14x15, 16x17, 18x19, 20x22, 21x23mm

£75.99

Part No. B034580

10pc Metric Double Open End Spanner Set



Set contains 1x of the following:
 • 6x7, 8x9, 10x11, 12x13, 14x15, 16x17, 18x19, 20x22, 21x23 & 24x27mm

£49.61

Part No. B034581

18pc Metric Combination Spanner Set

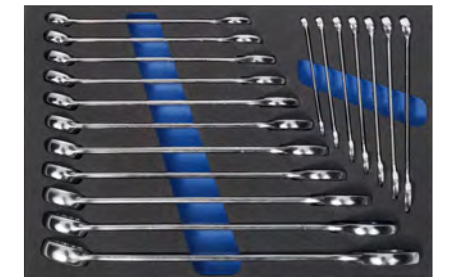

Set contains 1x of the following:
 • 6, 7, 8, 9, 10, 11, 12, 13, 14, 15, 16, 17, 18, 19, 21, 22, 24 and 27mm

£93.97

Part No. B034582

12pc Metric Combination Spanner Set



Set contains 1x of the following:
 • 6x7, 8x9, 10x11, 12x13, 14x15, 16x17, 18x19, 20x22, 21x23, 24x27, 30x 32 & 34 x 36mm

£50.41

Part No. B104488

16pc Metric Combination Spanner Set



Set contains 1x of the following:
 • 6, 7, 8, 9, 10, 11, 12, 13, 14, 15, 16, 17, 18, 19, 21 and 22mm

£55.55

Part No. B104490

19pc Metric Combination Spanner Set



Set contains 1x of the following:
 • 8, 9, 10, 11, 12, 13, 14, 15, 16, 17, 18, 19, 21, 22, 24, 27, 30, 32 and 34mm

£78.07

Part No. B104491

9pc Metric Open End Spanner Set



Set contains 1x of the following:
 • 6x7, 8x9, 10x11, 12x13, 14x15, 16 x17, 18x19, 20x22 & 21x23 mm

£39.67

Part No. B104486

14pc Crows Foot Wrench Set



- For use in hard to reach areas
- Designed for use with 1/2" Dr Extension
- Manufactured in Chrome Molybdenum
- Sizes: 27, 29, 30, 32, 33, 34, 35, 36, 38, 41, 43, 46, 48 and 50mm

£215.37

Part No. BT004713

14pc Combination Ratchet Ring Spanner Set



Set contains 1x of the following:
 • 6, 7, 8, 9, 10, 11, 12, 13, 14, 15, 16, 17, 18 & 19mm

£157.96

Part No. B371198

1/2" Dr TX Socket Bits



Part No.	Description	Qty	Price
B101021	TX20	1	£6.36
B101022	TX25	1	£6.36
B101023	TX27	1	£6.36
B101024	TX30	1	£6.60
B101025	TX40	1	£6.90
B101026	TX45	1	£6.90
B101027	TX50	1	£7.34
B183164	TX55	1	£7.34
B136381	TX60	1	£7.34

1/2" Dr Long TX Socket Bits

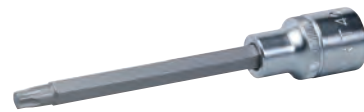

Part No.	Description	Qty	Price
B115452	TX20 x 124mm	1	£5.47
B115453	TX25 x 124mm	1	£6.99
B115451	TX27 x 124mm	1	£7.17
B115450	TX30 x 124mm	1	£7.52
B115446	TX40 x 124mm	1	£7.63
B115444	TX45 x 124mm	1	£7.77
B115454	TX50 x 124mm	1	£7.99
B115437	TX55 x 124mm	1	£8.51
B136382	TX70 x 100mm	1	£4.11
B134948	TX70 x 100mm	1	£4.31
B134949	TX80 x 70mm	1	£5.14

1/2" Dr Hex Socket Bits



Part No.	Description	Qty	Price
B235652	4mm	1	£6.26
B235660	5mm	1	£6.26
B235679	6mm	1	£6.26
B307327	7mm	1	£6.26
B235687	8mm	1	£7.11
B213721	10mm	1	£7.11
B213713	12mm	1	£7.66
B213705	14mm	1	£7.66
B213691	17mm	1	£8.60
B213683	19mm	1	£12.41

1/2" Dr Long Hex Socket Bits



Part No.	Description	Qty	Price
B214027	5 x 180mm	1	£5.86
B214035	6 x 140mm	1	£4.91
B214043	7 x 100mm	1	£3.73
B214019	8 x 80mm	1	£3.50
B213985	8 x 120mm	1	£4.19
B207745	9 x 140mm	1	£4.99
B214000	10 x 140mm	1	£5.07

6pc 1/2" Dr Torx Socket Bit Set



- 1/2" D socket bits: T55, T60, T70, T80, T90, T100
- Short series, length: 40mm
- Manufactured from chrome molybdenum for impact strength with anti-corrosion black phosphate finish
- Supplied in a metal case for easy workshop storage

£51.72

Part No. BT004947

3/8" Dr TX Socket Bits



Part No.	Description	Qty	Price
B250937	TX15	1	£2.24
B219606	TX20	1	£2.28
B219614	TX25	1	£2.71
B714968	TX27	1	£2.56
B714976	TX30	1	£2.77
B325074	TX40	1	£2.96
B051588	TX45	1	£6.14
B051589	TX50	1	£6.14

3/8" Dr Hex Socket Bits



Part No.	Description	Qty	Price
B209287	3mm	1	£2.92
B209279	4mm	1	£2.92
B209260	5mm	1	£2.92
B209252	6mm	1	£3.12
B209244	7mm	1	£3.12
B213241	9mm	1	£3.12
B213250	10mm	1	£3.12
B213268	12mm	1	£3.22

1/4" Dr TX Socket Bits



Part No.	Description	Qty	Price
B343080	TX8	1	£1.06
B121477	TX9	1	£1.23
B343102	TX10	1	£1.23
B343110	TX15	1	£1.23
B334790	TX20	1	£1.46
B343129	TX25	1	£1.46
B137830	TX27	1	£1.46
B343137	TX30	1	£1.46
B042548	TX40	1	£1.46

Hand Loop Ratchet



£20.92

Part No. B011590

Loop Ratchet Extension Bars



Part No.	Description	Qty	Price
B011582	75mm	1	£3.93
B011583	150mm	1	£8.02

Loop Ratchet Sockets



Part No.	Description	Qty	Price
B011548	8mm	1	£1.75
B011549	9mm	1	£1.84
B011550	10mm	1	£2.10
B011551	11mm	1	£1.80
B011554	12mm	1	£1.80
B011558	13mm	1	£1.80
B011559	14mm	1	£2.15
B011573	15mm	1	£2.15
B011574	16mm	1	£2.38
B011575	17mm	1	£2.40
B011577	18mm	1	£2.40
B011579	19mm	1	£2.40
B011580	21mm	1	£2.40
B011581	22mm	1	£3.22

Loop Ratchet Adapters



Part No.	Description	Qty	Price
B011592	1/4 Dr Adapter	1	£2.22
B128911	1/4 Dr Adapter	1	£8.94
B128908	3/8 Dr Adapter	1	£9.61
B011593	1/2 Dr Adapter	1	£3.50

Loop Ratchet Bit Adaptors



Part No.	Description	Qty	Price
B011594	1/4 Hex Bit	1	£1.87
B011595	10mm Hex Bit	1	£1.36

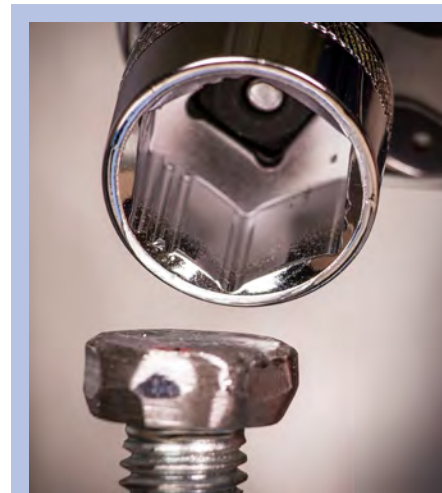

11pc 3/8" Dr Lock-On 6pt Imperial Socket Set



- Includes: 5/16", 3/8", 7/16", 1/2", 9/16", 5/8", 11/16", 3/4", 13/16", 7/8", 15/16" & Socket Rail

£32.44

Part No. AK2740

12pc 3/8" Dr Lock-On 6pt Metric Socket Set

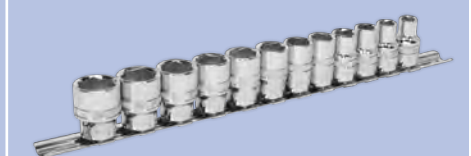

- Includes: 8, 9, 10, 11, 12, 13, 14, 15, 16, 17, 18, 19mm & Socket Rail

£35.95

Part No. AK2741

13pc 1/2" Dr Lock-On 6pt Metric Socket Set



- Includes: 10, 11, 12, 13, 14, 15, 16, 17, 18, 19, 21, 22, 24mm & Socket Rail

£49.95

Part No. AK2742

11pc 3/8" Dr Deep Lock-On 6pt Imperial Socket Set



- Includes: 5/16", 3/8", 7/16", 1/2", 9/16", 5/8", 11/16", 3/4", 13/16", 7/8", 15/16" & Socket Rail

£51.95

Part No. AK2743



1/2" Dr Wobble Extension Bar



• Chrome-Vanadium steel

Part No.	Description	Qty	Price
B033507	50mm	1	£6.09
B038698	125mm	1	£8.93
B038699	250mm	1	£10.56

3/8" Dr Wobble Extension Bar



• Chrome-Vanadium steel

Part No.	Description	Qty	Price
B038696	75mm	1	£2.60
B045156	125mm	1	£3.53
B038697	250mm	1	£5.89

1/4" Dr Wobble Extension Bar



• Chrome-Vanadium steel

Part No.	Description	Qty	Price
B045155	50mm	1	£3.00
B038695	100mm	1	£3.60

3/4" Dr Extension Bar



• Chrome-Vanadium steel

Part No.	Description	Qty	Price
B105825	200mm	1	£23.50
B105826	400mm	1	£27.52

1/2" Dr Extension Bar



• Chrome-Vanadium steel

Part No.	Description	Qty	Price
B105787	75mm	1	£3.16
B105788	500mm	1	£17.85

Socket Adaptors



1



2

• Chrome-Vanadium steel

Part No.	Description	Qty	Price
B063622	1/4 (F) to 3/8 (M)	1	£2.28
1 B064114	3/8 (F) to 1/2 (M)	1	£2.64
B065099	1/2 (F) to 3/4 (M)	1	£6.58
B063630	3/8 (F) to 1/4 (M)	1	£2.75
2 B064122	1/2 (F) to 3/8 (M)	1	£2.51
B065897	3/4 (F) to 1/2 (M)	1	£8.90

Universal Joint



Part No.	Description	Qty	Price
B890359	1/4 Dr	1	£7.92
B890618	3/8 Dr	1	£8.64
B890952	1/2 Dr	1	£11.89

3/4" Dr Sockets



Part No.	Description	Qty	Price
B105806	19mm	1	£5.05
B008781	20mm	1	£5.05
B105807	21mm	1	£5.05
B105808	22mm	1	£5.05
B008782	23mm	1	£5.05
B105809	24mm	1	£5.14
B008783	25mm	1	£6.25
B008784	26mm	1	£6.25
B105810	27mm	1	£6.25
B105811	30mm	1	£6.46
B105812	32mm	1	£6.78
B105814	34mm	1	£6.78
B105815	36mm	1	£8.02
B105816	38mm	1	£8.34
B105817	41mm	1	£9.39
B105818	46mm	1	£12.07
B105819	50mm	1	£12.30
B105820	55mm	1	£15.44
B105822	60mm	1	£19.02

1/2" Dr Sockets



Part No.	Description	Qty	Price
B155958	10mm	1	£2.64
B155959	11mm	1	£2.64
B155960	12mm	1	£3.04
B155961	13mm	1	£3.04
B155962	14mm	1	£3.04
B155963	15mm	1	£3.04
B155964	16mm	1	£3.04
B155965	17mm	1	£3.36
B155966	18mm	1	£3.36
B155967	19mm	1	£3.52
B155968	20mm	1	£3.52
B155970	21mm	1	£3.77
B155971	22mm	1	£3.77
B155972	23mm	1	£3.77
B155973	24mm	1	£3.77
B155975	26mm	1	£3.77
B155976	27mm	1	£4.47
B155978	28mm	1	£5.06
B155980	30mm	1	£5.06
B155981	32mm	1	£5.34

1/2" Dr Deep Sockets



Part No.	Description	Qty	Price
B171399	10mm	1	£3.38
B171398	11mm	1	£3.41
B171397	12mm	1	£3.51
B171396	13mm	1	£3.58
B171395	14mm	1	£3.66
B171394	15mm	1	£3.66
B171393	16mm	1	£3.76
B171392	17mm	1	£3.76
B171391	18mm	1	£3.91
B171390	19mm	1	£3.91
B057065	22mm	1	£4.00

1/2" Dr Bi-Hex Deep Sockets



Part No.	Description	Qty	Price
B174498	10mm	1	£3.88
B331112	12mm	1	£3.95
B134017	13mm	1	£3.36
B332224	14mm	1	£3.29
B124184	15mm	1	£3.34
B370819	16mm	1	£3.54
B292389	17mm	1	£3.66
B181480	18mm	1	£3.70
B296988	19mm	1	£3.89
B411388	21mm	1	£4.08
B319775	22mm	1	£4.51
B319783	24mm	1	£4.97
B192147	27mm	1	£7.05
B317039	30mm	1	£7.08
B174499	32mm	1	£7.71

1/2" Dr I-Sockets



Part No.	Description	Qty	Price
B175813	10mm	1	£1.86
B175814	11mm	1	£1.84
B175815	12mm	1	£2.00
B175816	13mm	1	£1.78
B175817	14mm	1	£1.82
B175818	15mm	1	£3.37
B175819	16mm	1	£3.51
B175820	17mm	1	£3.51
B175821	18mm	1	£3.69
B175822	19mm	1	£3.69
B175823	20mm	1	£3.69
B175824	21mm	1	£3.76
B175825	22mm	1	£3.76
B175826	24mm	1	£4.04
B175827	27mm	1	£4.04
B175828	30mm	1	£4.17
B175829	32mm	1	£4.29

1/2" Dr TX Sockets



Part No.	Description	Qty	Price
B261157	E10-TX	1	£1.54
B261165	E12-TX	1	£3.06
B105799	E14-TX	1	£2.97
B363251	E16-TX	1	£2.97
B105800	E18-TX	1	£3.32
B105801	E20-TX	1	£3.84
B105802	E24-TX	1	£4.47

3/8" Dr Sockets



Part No.	Description	Qty	Price
B155937	6mm	1	£2.32
B155938	7mm	1	£2.32
B155939	8mm	1	£2.32
B155940	9mm	1	£2.32
B155941	10mm	1	£2.32
B155943	11mm	1	£2.46
B155944	12mm	1	£2.46
B155945	13mm	1	£2.46
B155946	14mm	1	£2.64
B155947	15mm	1	£2.64
B155948	16mm	1	£2.64
B155949	17mm	1	£2.90
B155951	18mm	1	£2.90
B155952	19mm	1	£2.90
B155953	20mm	1	£2.90
B155954	21mm	1	£2.90
B155955	22mm	1	£2.90

3/8" Dr Deep Sockets



Part No.	Description	Qty	Price
B054854	7mm	1	£2.56
B054855	8mm	1	£2.56
B054860	9mm	1	£2.59
B054862	10mm	1	£2.59
B054863	11mm	1	£2.59
B054864	12mm	1	£2.78
B054865	13mm	1	£2.78
B054866	14mm	1	£3.52
B054867	15mm	1	£3.56
B054868	16mm	1	£3.88
B054869	17mm	1	£4.05
B054870	18mm	1	£4.05
B054871	19mm	1	£4.69
B054872	20mm	1	£5.13
B054873	21mm	1	£5.18
B054874	22mm	1	£5.18

3/8" Dr Bi-Hex Deep Sockets



Part No.	Description	Qty	Price
B174496	8mm	1	£2.32
B106125	9mm	1	£2.32
B213497	10mm	1	£2.32
B213500	11mm	1	£2.32
B213519	12mm	1	£2.32
B213527	13mm	1	£2.34
B213535	14mm	1	£2.34
B213551	15mm	1	£2.34
B174497	16mm	1	£2.55
B213543	17mm	1	£2.55
B213560	19mm	1	£2.97

3/8" Dr TX Sockets



Part No.	Description	Qty	Price
B105795	E8-TX	1	£2.49
B105796	E10-TX	1	£2.06
B105797	E12-TX	1	£2.64
B105798	E14-TX	1	£2.18

1/4" Dr Deep Sockets



Part No.	Description	Qty	Price
B057063	4mm	1	£1.73
B057064	5mm	1	£1.73
B420948	6mm	1	£1.73
B420956	7mm	1	£1.73
B338222	8mm	1	£1.78
B420964	9mm	1	£1.78
B339210	10mm	1	£1.78
B924733	11mm	1	£1.78
B924741	12mm	1	£1.97
B417068	13mm	1	£1.97
B174495	14mm	1	£1.97

1/4" Dr E-TX Sockets



Part No.	Description	Qty	Price
B105790	TX4	1	£1.38
B105792	TX5	1	£1.51
B105793	TX6	1	£1.55
B668583	TX7	1	£1.74
B105794	TX8	1	£1.77
B668605	TX10	1	£1.89

1/4" Dr Sockets



Part No.	Description	Qty	Price
B155922	4mm	1	£0.70
B155923	4.5mm	1	£0.70
B155924	5mm	1	£0.70
B155925	5.5mm	1	£0.74
B155927	6mm	1	£0.74
B155929	8mm	1	£0.76
B155930	9mm	1	£0.76
B155931	10mm	1	£0.76
B155932	11mm	1	£0.76
B155933	12mm	1	£0.76
B155935	13mm	1	£1.08
B155936	14mm	1	£1.17

1/4" Dr I-Sockets



Part No.	Description	Qty	Price
B170934	4mm	1	£1.76
B170935	4.5mm	1	£2.17
B170936	5mm	1	£0.76
B170937	5.5mm	1	£0.83
B170938	6mm	1	£0.83
B170939	7mm	1	£0.83
B170940	8mm	1	£0.83
B170941	9mm	1	£0.85
B170942	10mm	1	£0.85
B170943	11mm	1	£0.85
B170944	12mm	1	£0.97
B170945	13mm	1	£0.97
B170946	14mm	1	£1.66

1" Dr Impact Extension Bar L200mm



£32.74

Part No. B133917

3/4" Dr Impact Extension Bar L200mm



£34.95

Part No. AK5507

1/2" Dr Impact Extension Bar L125mm



£8.29

Part No. B151920

Impact Socket Adaptors



Part No.	Description	Qty	Price
1 B138604	1/2 (F) to 3/4 (M)	1	£9.42
1 B147402	3/4 (F) to 1in (M)	1	£17.63
2 B138605	3/4 (F) to 1/2 (M)	1	£14.12
2 B138607	1in (F) to 3/4 (M)	1	£18.49

1/2" Dr Impact Universal Joint



£12.31

Part No. B133910

1/2" Dr 36mm Thin Wall Hub Nut Socket



- Applications include: Ford KA; Fiat 500
- Size: 1/2" D x 36mm
- 78mm Long
- Manufactured from chrome molybdenum

£15.93

Part No. BT006279

1" Dr x 50mm Deep Impact Socket



- Manufactured from chrome molybdenum

£76.74

Part No. BT004694

1" Dr Impact Sockets



- Manufactured from Chrome Molybdenum
- 6 point x 71mm deep
- Black phosphate finish

Part No.	Description	Qty	Price
BT006504	80mm	1	£156.31
BT006507	100mm	1	£177.31
BT006508	110mm	1	£191.67
BT006509	120mm	1	£194.94
BT006510	140mm	1	£305.80

3/8 Dr 11 Point Brake Caliper Socket



£6.70

Part No. BT006243

1/2" Dr Wheel Bolt Impact Sockets



- Chrome-Vanadium steel, burnished
- The plastic stopper in the cap prevents damage to chrome wheel nuts

Part No.	Description	Qty	Price
B330450	17mm	1	£9.58
B123273	19mm	1	£10.57

1/2" Dr Premium Alu Power Cap



- Power caps, especially for aluminum rims
- Aluminum rims are protected by the plastic outer sleeve on the power cap

Part No.	Description	Qty	Price
B245245	15mm	1	£5.89
B245242	17mm	1	£6.20
B245244	17mm Mercedes	1	£8.91
B245241	19mm	1	£5.70
B245240	21mm	1	£6.89
B245239	22mm	1	£8.38

3/4 Dr Impact Star Sockets



- For removing the cylinder head bolts from engines and other heavy duty applications
- Manufactured from chrome molybdenum

Part No.	Description	Qty	Price
BT004560	E18 x L90mm	1	£29.27
BT004561	E20 x L90mm	1	£31.25
BT004562	E24 x L90mm	1	£31.53

1/2" Dr Impact Sockets



Part No.	Description	Qty	Price
B133879	10mm	1	£3.21
B070041	13mm	1	£3.28
B133882	14mm	1	£3.49
B117744	15mm	1	£3.64
B355950	16mm	1	£3.87
B070076	17mm	1	£3.97
B355968	18mm	1	£3.97
B070084	19mm	1	£4.02
B133884	21mm	1	£4.17
B070092	22mm	1	£4.17
B070106	24mm	1	£4.49
B133888	27mm	1	£5.92
B133891	30mm	1	£6.14
B133893	32mm	1	£6.14
B180930	33mm	1	£28.22

1/2" Dr Deep Impact Sockets



Part No.	Description	Qty	Price
B213799	13mm	1	£4.82
B117743	15mm	1	£5.32
B133875	16mm	1	£5.89
B177717	17mm	1	£5.89
B133877	18mm	1	£5.96
B177725	19mm	1	£5.96
B192295	21mm	1	£6.14
B213780	22mm	1	£6.14
B213772	24mm	1	£7.24
B213764	27mm	1	£8.17
B134895	30mm	1	£9.16
B134896	32mm	1	£10.22
B188259	33mm	1	£34.07

3/4" Dr Impact Sockets



Part No.	Description	Qty	Price
B151262	17mm	1	£11.9
B151270	19mm	1	£12.62
B122483	22mm	1	£12.62
B122491	24mm	1	£12.62
B122505	27mm	1	£12.62
B151289	30mm	1	£14.06
B151297	32mm	1	£14.06
B133865	33mm	1	£15.42
B151300	36mm	1	£15.54
B133867	38mm	1	£16.09
B133869	41mm	1	£17.74
B135835	46mm	1	£20.12

3/4" Dr Deep Impact Sockets



Part No.	Description	Qty	Price
B133852	17mm	1	£14.04
B133854	19mm	1	£14.04
B213756	22mm	1	£14.04
B213748	24mm	1	£17.69
B213730	27mm	1	£18.70
B215406	30mm	1	£19.97
B215392	32mm	1	£19.97
B133857	33mm	1	£20.72
B102077	34mm	1	£22.91
B215384	36mm	1	£23.19
B133858	38mm	1	£26.72
B133859	41mm	1	£27.74
B135836	46mm	1	£35.04

1" Dr Impact Sockets



Part No.	Description	Qty	Price
B122521	24mm	1	£17.64
B122530	27mm	1	£15.55
B151408	30mm	1	£15.95
B151416	32mm	1	£15.95
B133896	33mm	1	£16.12
B151424	36mm	1	£16.24
B133898	38mm	1	£17.55
B151432	41mm	1	£21.56
B151440	46mm	1	£22.25
B133900	50mm	1	£22.29
B133901	55mm	1	£27.25
B133902	60mm	1	£30.50
B133903	65mm	1	£36.36
B133904	70mm	1	£43.98

1" Dr Deep Impact Sockets



Part No.	Description	Qty	Price
B250096	22mm	1	£50.79
B215317	24mm	1	£20.10
B215325	27mm	1	£20.10
B215333	30mm	1	£22.79
B215341	32mm	1	£22.79
B133907	33mm	1	£24.09
B102078	34mm	1	£25.34
B215350	36mm	1	£25.34
B133908	38mm	1	£26.38
B215368	41mm	1	£30.69
B215376	46mm	1	£29.10
B333019	65mm	1	£93.47
B250069	90mm	1	£221.07
B250070	95mm	1	£289.15

3/4" Dr 95mm BPW Rear Hub Cap Nut Socket



- Manufactured from black finish Carbon Steel
- Heavy duty construction

£155.66

Part No. BT005598

1" Dr 85mm Hub Nut Socket



- Length 102mm
- Manufactured from chrome molybdenum
- Weight 4.22 kgs
- Suitable for commercial vehicle hub nuts
- For use on Mercedes-Benz Actros, Scania and SAF Trailers

£133.29

Part No. BT005714

1" Dr 95mm Hub Nut Socket



- Size: 95mm single Hex x 1" Dr
- For general use and suitable for Mercedes-Benz 'discos' axles

£217.88

Part No. BT005200

3/4" Dr 115mm Wheel Shaft Cover Socket



- 8 point socket
- For Volvo commercial vehicles, front and rear axle covers

£199.12

Part No. BT005323

3/4" Dr 105-125mm Lock Nut Socket



- For rear axles on Mercedes-Benz Actros HL & HL8
- Grooved profile with 6 studs x 3/4" Dr

£215.93

Part No. BT005327

80mm Hex Dr Front Hub Nut Socket



- Specifically for front hub nuts on Scania trucks
- 8-sided
- Equivalent to OEM 99307

£166.50

Part No. BT004400

3/4" Dr 100mm Rear Hub Nut Socket



- Suitable for Scania HGV's
- 8-sided

£197.21

Part No. BT004563

3/4" Dr 80-95mm Lock Nut Socket



- Application: Mercedes-Benz Atego rear axle on Vario 814 and MAN
- Grooved profile with 6 studs x 3/4" Dr

£171.82

Part No. BT005326

3/8" Dr 36mm Oil Filter Socket



- Applications include: Vauxhall, Opel 16v (from 1998); BMW 24v petrol/diesel engines; Mercedes-Benz 116 MB engine Vito CDI; Ford vehicles with Duratorq diesel engines & newer style Transit vans
- Additional applications: VAG 1.9 SDi (ASY); Ford and Jaguar 2.2 D; BMW MINI R56; Mercedes-Benz 606

£15.62

Part No. BT003491

Diesel Injection Nozzle Socket



- Complete with the M14 puller
- Easy to use
- The specially designed toothed socket is for installing and removing the diesel injection nozzle on commercial vehicles

£41.80

Part No. BT004720

1" Dr 105mm Hub Nut Socket



- Single HEX
- Manufactured from Chrome Molybdenum
- Impact quality

£281.02

Part No. BT004815

Torque Multiplier 1"D



- Designed for removing the highly torqued wheel nuts on light commercials and trucks, up to a maximum of 3200Nm (2360lb-ft)
- Contents: 1"D Torque Multiplier, Torque Rocker handle, Extension Bar, Reaction Foot, Fixing screw and 4 x 1"D Sockets x 6pt: 30mm, 32mm, 38mm, 41mm
- Gear Ratio: 1:56

£366.80

Part No. BT007086

95mm Axle Nut Socket



- Use with 36mm socket or spanner
- For use on Mercedes-Benz axles trailers

£315.14

Part No. BT005293

65mm BPW Axle Nut Socket



- For removing the asymmetrical hub nuts on BPW axles
- Use with 36mm spanner or socket
- Equivalent to OEM 03.364.20.03.0
- For 6 to 9 tonne conventional and Eco axles (type H/K/N)

£160.36

Part No. BT005317



3/4" Dr 95-115mm Lock Nut Socket



- For rear & trailer axels
- Grooved profile
- For use on Mercedes-Benz 10/13t Reduction Axle, Hypoid and Trailer Axle No 7/4. Bus 0305 G and 0405 G

£231.44

Part No. BT005328

140mm Axle Nut Socket



- Application: SAF Euro Axle
- 32mm & 46mm Hex drive
- Selected steel black finish
- Heavy duty construction

£153.50

Part No. BT005329

110mm BPW Rear Hub Cap Nut Socket



- Use with 41mm spanner or socket
- For use on BPW Trailers BPW12TN

£192.94

Part No. BT005597

24pc 1/2" Dr Socket Set



- Includes: 10, 11, 12, 13, 14, 15, 16, 17, 18, 19, 21, 22, 24 & 27mm, 5/6" Hex Bits, Universal joint, wobble extension bars, T-sliding handle, 5/16 bit adapter and disc ratchet

£93.78

Part No. B039889

8pc 1/4" Dr T-Ratchet Set



- Includes: 8, 10, 11, 12 & 13mm sockets, 1/4 dr bit adapter, swiveling extension bar and T handle ratchet

£31.83

Part No. B088433

24pc Impact Bit & Socket Set 3/4" Dr & 1" Dr



Contents

- 4 x Star impact sockets: E18, E20, E22, E24. 107mm deep
- Adaptors: 1"D x 22mm Hex x 62mm long; 3/4"D x 22mm Hex x 52mm long; 1 x 2.5mm Hex key for locking the bit into the driver
- 9 x Hex impact bits: 14, 17, 19, 21, 22mm (in alloy steel); 24, 27, 30, 32mm (in carbon steel)
- 3 x Spline impact bits: M16, M18, M20; 5 x Star* impact bits: T60, T70, T80, T90, T100 (in alloy steel)

- A dual 3/4" & 1"D impact socket & bit set with Hex, Star* & Spline profiles, ideal for use on commercial vehicle applications
- Sockets manufactured from chrome molybdenum

£181.27

Part No. BT006891

25pc 1/2" Dr Socket Set



- Includes: 10, 11, 12, 13, 14, 15, 16, 17, 18, 19, 20, 21, 22, 23, 24, 26, 27, 28, 30 & 32mm sockets, Universal joint, wobble extension bars, t-sliding handle and disc ratchet

£101.66

Part No. B039890

16pc 3/4" Dr Metric Socket Set



- Includes: 27, 30, 34, 36, 38, 46 & 50mm sockets, extension bar, T-sliding handle and disc ratchet

£266.56

Part No. B105803

41pc 1/2" Dr I-Socket Set



- Includes: 10, 11, 12, 13, 14, 15, 16, 17, 18, 19, 20, 21, 22, 24, 27, 30 & 32mm sockets, 10mm Hex bits, 10mm TX bits, 10mm XZN insert bits, universal joint, extension bars, t-sliding handle and disc ratchet

£113.04

Part No. B048559

Socket Rails



Number of Clips

- B042550 - 12 Clips
- B042551 - 13 Clips
- B042552 - 16 Clips

Part No.	Description	Qty	Price
B042550	1/4 in Socket Rail	1	£1.62
B042551	3/8 in Socket Rail	1	£1.58
B042552	1/2 in Socket Rail	1	£2.12

16pc Impact Bit & Socket Set 3/4" Dr & 1" Dr



Contents

- 4 Star* impact sockets: E18, E20, E22, E24
- 2 x impact socket adaptors: 3/4"D & 1"D
- 9 x impact bits: Hex 17, 19, 22, 24mm; TX Star T60, T70, T80, T90, T100
- 1 x H4 Hex key for locking the bit into the driver

- A dual 3/4" & 1"D impact socket & bit set in Hex & Star* profiles, for commercial vehicle and heavy duty applications
- Sockets manufactured from chrome molybdenum

£192.38

Part No. BT007128

12pc 1/2" Dr Deep Impact Socket Set



- Includes: 13, 15, 16, 17, 18, 19, 21, 22, 24, 27, 30 & 32mm
- Sockets are fitted into foam insert tray
- Made from burnished chrome-Vanadium steel

£103.53

Part No. B052118

3pc 1/2" Dr Alloy Wheel Impact Socket Set



- Includes: 17, 19 & 21mm
- Colour coded sockets
- Aluminium rims are protected by the plastic outer sleeve

£26.40

Part No. B245246

6pc 3/4" Dr Deep Impact Socket Set



- Includes: 24, 27, 30, 32, 33 & 36mm
- Comes in metal storage case
- Chrome vanadium steel, burnished

£102.95

Part No. B168433

8pc 1/2" Dr Hex Impact Socket Set



- Includes: 13, 16, 17, 18, 19, 21, 22 & 24mm
- Comes in metal storage case

£52.37

Part No. B042549

24pc 1/4" Dr Finger Ratchet Set



- Includes: Finger Ratchet for 1/4" Dr sockets, Finger Ratchet for 1/4" Dr bits, I-sockets in sizes 6 to 13mm, 16 1/4" bits covering TX PH PZ and Hex
- Two finger operation for use in tight spaces

£33.04

Part No. B030363

34pc 1/4" Dr Socket Set



- Includes: 4, 4.5, 5, 5.5, 6, 7, 8, 9, 10, 11, 12 & 13mm Sockets, PH bits, Slotted Bits, Hex bits, TX bits, 1/4 Dr T-sliding handle, universal joint, screwdriver, extension bars and disc ratchet

£75.03

Part No. B039886

19pc 1/4" Dr Socket Set



- 19pc socket set with renewed profile, matching 6-point, 12-point, metric and imperial, and Torx sockets
- Can be used in hard to reach areas due to compact ratchet with short stroke (72 teeth-5°)

£65.54

Part No. B213274

25pc TX Socket Wrench Set



- Sockets Box TX and ETX with 1/4 - 3/8 - 1/2 drive
- Includes: TX sockets, 1/4 TX bits, 5/16 TX bits and bit holders all in convenient metal storage box

£61.83

Part No. B106149

17pc 3/8" Dr Socket Set



- Includes: 8, 9, 10, 11, 12, 13, 14, 15, 16, 17, 18 & 19mm sockets, Extension bars, Sliding t-handle, universal joint, and ratchet
- Fine-toothed ratchet (72 teeth - 5°)

£70.53

Part No. B039887

Oil Filter Chain Wrench 60-160mm



- To remove large oil filters on trucks and machinery
- Solid export oil filter wrench made of high quality steel, with cardan joint
- Double chain length: 520mm
- Clamping range ø 60 - 160mm

£47.60

Part No. B061669

3/8 - 1/2 Dr 62-96mm Claw Oil Filter Wrench



- 3 clamp legs
- Clamping range adapts automatically
- Can be used both left and right
- Removable gradient: 1/2 - 3/8
- Hexagon: Size 21
- Clamping range: Ø 62 - 96mm

£32.84

Part No. B140246

280mm 1/2 Dr HD Oil Filter Strap Wrench



- Satin finish cast steel body with 3/8" and 1/2" Sq drive
- Designed for use with ratchet wrench, but may also be used with a 21mm(13/16") spanner
- Extra-wide nylon webbing strap

£24.25

Part No. 910339

Oil Filter Wrench 1/2 Dr



- For removing different types of oil filter cartridges
- Clamping range: max. Ø 110mm
- Chain length: 380mm

£8.86

Part No. B823447

Oil Filter Band Wrenches



- For the removal of oil filter cartridges
- Easily adjustable via robust rotary
- Length steel band: 380mm
- Jack: approx 160mm
- Clamping Range: 65 - 110mm

£27.78

Part No. B141136

Oil Filter Strap Wrench



- Polyester web strap with steel tightening shank. The shank has a 13/16" external hex and a 1/2" internal square drive
- Suitable for removing oil, fuel and water filters, gripping hubs and brake drums, removing exhausts etc
- The compact design allows use in confined spaces

£43.34

Part No. 816280

16pc 3/8 or 1/2 Dr Oil Cap Filter Wrench Set



- Especially for vehicle maintenance and service
- Unloading of oil-filter cartridges and filter housings
- Suitable for all common European vehicles
- Including flexible filter spin Ø 65 - 120mm
- Includes adapter from 1/2 - 3/8 jack

£78.29

Part No. B005633

8-in-1 Oil Drain Plug Wrench



- Universally deployable special key for oil fill and drain plugs on sump, gearbox and differential
- Quick selection of the appropriate key profile by two key swivel heads with snap lock
- 4 side sizes: 8 - 10 - 3/8 - 1/2 sq drives
- 6 side sizes: 10 - 12 - 14 and 17mm

£32.38

Part No. B153197

Reversible Square Drive Torque Wrenches



- Accurate tightening and checking of screw connections both clockwise and counter clockwise
- Adjustable torque wrench with integrated ratchet function
- Accuracy: ± 3% of the set value
- Double scale Nm and lbf.in/lb.ft
- Quick and easy adjustment of the different torques with lock
- Easy to read scale with magnifier window & mark to prevent setting errors
- Test certificate according to DIN / ISO 6789

Part No.	Description	Qty	Price
B120324	1/2 Reversible Sq Dr x 400mm 20-100 Nm	1	£165.19
B120332	1/2 Reversible Sq Dr x 485mm 40-200Nm	1	£139.27
B120340	1/2 Reversible Sq Dr x 577mm 60-300Nm	1	£142.89
B120350	3/4 Reversible Sq Dr x 625mm 80-400 Nm	1	£294.65
B120351	3/4 Reversible Sq Dr x 1236mm 150-750Nm	1	£409.92
B120318	3/8 Reversible Sq Dr x 335mm 10-50Nm	1	£126.50
B120362	1/4 Reversible Sq Dr x 285mm 5-25Nm	1	£179.19

Drive for Torque Wrenches

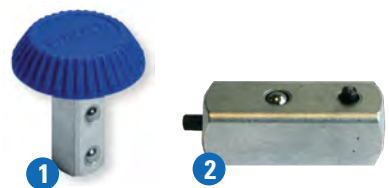

Part No.	Description	Qty	Price
B139858	1/4 Dr for Torque Wrench B120362	1	£29.70
B139870	3/8 Dr for Torque Wrench B120318	1	£19.87
B139874	1/2 Dr for Torque Wrench B120332/ B120340	1	£18.99
B115076	3/4 Dr for Torque Wrench B120351	1	£17.07

Torque Wrenches



- Robust construction: accurate results to ±4% (even in arduous working conditions) Large break angle improves accuracy by reducing the possibility of over torquing and the cam control of the mechanism gives a controlled break which will not throw the operator off balance
- Dual scaled, with both Nm (Newton Meters) and lb.ft graduations
- Supplied with a declaration of conformance to satisfy the requirements of ISO 6789:2017 and carry case for storage and protection

Part No.	Description	Qty	Price
837312	5R 1" Dr 300-1000Nm	1	£472.66
837329	3/4 to 1 Square Drive For 5R	1	£69.00
837310	4R 3/4" Dr 150-700Nm	1	£430.24
837327	3/4" Dr Replacement for 4R	1	£20.80
837308	1/2" Dr 60-330Nm	1	£193.11
837325	1/2" Dr Replacement for 330	1	£37.61

Spanner Extension Wrench



- The extension wrench firmly grips the shaft of the spanner and thus extends the leverage and exerts a greater force on the fastener
- Length: 385mm
- Provides extra leverage to loosen fasteners in hard to reach areas
- Universal use with any spanner or hex key
- Manufactured from chrome vanadium with polished finish

£33.75
Part No. BT006745

Sliding T-Handles



Part No.	Description	Qty	Price
B890324	1/4 Dr x 115mm	1	£3.73
B890588	3/8 Dr x 200mm	1	£12.58
B890910	1/2 Dr x 275mm	1	£8.37
B105824	3/4 Dr x 425mm	1	£44.26
B136840	1 in Dr x 640mm	1	£52.95

1/2" Dr L250mm long Sliding T-Handle with Extension



£7.99
Part No. B175832

Nut Drivers



- Slim ergonomic handle
- Chrome plated - Satin finish

Part No.	Description	Qty	Price
B218481	4mm	1	£4.73
B218482	4.5mm	1	£4.24
B218483	5mm	1	£4.72
B218484	5.5mm	1	£4.24
B218485	6mm	1	£5.03
B218486	7mm	1	£5.25
B218487	8mm	1	£5.16
B218488	9mm	1	£5.19
B218489	10mm	1	£5.36
B218490	11mm	1	£7.16
B218491	12mm	1	£6.02
B218492	13mm	1	£6.13

Extendable Telescopic Pivot Head Ratchets



- Reversing mechanism with detent
- Head can be swiveled 180°
- Telescopic handle can be locked at different levels or positions
- 72 teeth - fine teeth
- Length: 290 - 490mm

Part No.	Description	Qty	Price
B061905	3/8 Dr 255-325mm	1	£33.00
B061906	1/2 Dr 290-490mm	1	£63.03

1/4" Dr T-Ratchet 125mm



- Pivoting head with folding handle
- For working in narrow spaces
- 72 teeth - fine teeth

£27.63
Part No. B090927

Breaker Bars

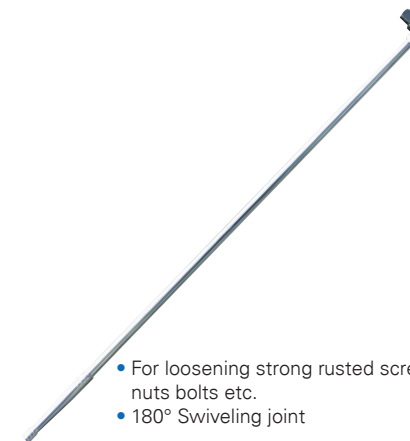

- For loosening strong rusted screws, nuts bolts etc.
- 180° Swiveling joint

Part No.	Description	Qty	Price
B215414	1/2 Dr 375mm	1	£10.63
B333694	1/2 Dr 620mm	1	£27.32
B027720	3/4 Dr 1000mm	1	£80.52

3/4" Dr 505mm Ratchet



- Switch lever for left-right
- Chrome vanadium steel

£88.78
Part No. B105823

1" Dr HD Ratchet with Sliding T-Bar



- 24 teeth ratchet mechanism
- Complete with sliding T-bar adaptor
- Manufactured from chrome vanadium

£206.31
Part No. BT002720

1" Dr 650mm Ratchet



- Removable extension
- Switch lever for left right
- Chrome vanadium steel

£81.51
Part No. B136875

Ratchets



- Fine-toothed ratchet (72 teeth - 5°)
- Chrome vanadium steel

Part No.	Description	Qty	Price
B57607	1/4 Dr L120mm	1	£18.00
B57608	3/8 Dr L175mm	1	£22.41
B57609	1/2 Dr L250mm	1	£24.85

Heavy Duty Ratchets



- Heavy duty version
- Reversing mechanism with lever for left right
- 36 Teeth
- Safe blocking of the cap, ball lock with push button

Part No.	Description	Qty	Price
B121783	1/4 Dr H/D L125mm	1	£17.36
B121786	3/8 Dr H/D L175mm	1	£20.44
B121787	1/2 Dr H/D L255mm	1	£26.19

Premium Ratchets



- Equipped with fine teeth (60) for optimal power transmission
- With lever for easy switching from left and right
- High stability and low wear
- Can be used in small spaces
- Ergonomic handle for optimum ease of use

Part No.	Description	Qty	Price
B210478	1/4 Dr L146mm	1	£16.12
B210479	3/8 Dr L202mm	1	£19.86
B210480	1/2 Dr L253mm	1	£37.38

3/8" Dr Bit Adaptors



Part No.	Description	Qty	Price
1 B000861	For 10mm Bits	1	£4.04
2 B102410	For 5/16" Bits	1	£4.84
B105789	For 1/4" Bits	1	£3.75

1/2" Dr Bit Adaptors



Part No.	Description	Qty	Price
B000859	For 1/2" Bits	1	£4.95
B890898	For 5/16" Bits	1	£3.95
B751340	For 10mm Bits	1	£4.84

3pc Bit Adaptor Set 1/4", 3/8" & 1/2"



• 1/2" variant comes with 5/16" hexagonal machine connection

£20.38

Part No. B207758

Magnetic Screwdriver Bit Holder



- The screw head is firmly attached to the inserted ring magnet
- Maximum guidance and strength of the screw
- Extremely suitable for hard-to-reach places and work where you can only screw with one hand
- Adjustable ring magnet also serves as a depth stop

Part No.	Description	Qty	Price
B163113	Maxi	1	£9.35
B163114	Mini	1	£8.31

1/4" Dr 10mm Bit Adapter

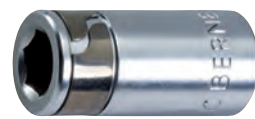

- Suitable for 1/4 Dr bits
- Chrome-vanadium steel

£1.31

Part No. B890286

1/4" Dr Magnetic Bit Holders



- For machines with cylindrical connection
- Hexagon 1/4" bit chuck
- Magnetic

Part No.	Description	Qty	Price
B51730	58mm	1	£5.42
B470892	75mm	1	£5.82

5/16 x 32mm No3 Pozzi Hex Impact Screwdriver Bit



£2.50

Part No. 810694

1/4" Dr Slotted Bits



Part No.	Description	Qty	Price
B150635-5	0.5 x 3 - L25mm	5	£5.69
B137917-5	0.6 x 4.5 - L25mm	5	£4.65
B137918-5	0.8 x 5.5 - L25mm	5	£4.51
B070262-5	1.2 x 6.5 - L25mm	5	£4.27

1/4" Dr PH Bits



Part No.	Description	Qty	Price
B070181-10	PH1 x 25mm	10	£10.55
B029142-5	PH1 x 70mm	5	£20.65
B934540	PH1 x 90mm	1	£5.27
B070190-10	PH2 x 25mm	10	£10.55
B029145-5	PH2 x 70mm	5	£24.66
B934543	PH2 x 90mm	1	£6.55
B070203-10	PH3 x 25mm	10	£10.55
B029148-5	PH3 x 70mm	5	£24.66
B934548	PH3 x 110mm	1	£7.54

10mm Dr XZN Bits



Part No.	Description	Qty	Price
B000867	5 x 30mm	1	£0.86
B115559	5 x 75mm	1	£1.06
B000866	6 x 30mm	1	£1.13
B000865	6 x 75mm	1	£4.22
B000864	8 x 30mm	1	£1.13
B000863	8 x 75mm	1	£1.33
B000872	10 x 30mm	1	£1.13
B000871	10 x 75mm	1	£1.33
B000869	12 x 30mm	1	£1.05
B000868	12 x 75mm	1	£1.38

10mm Drive HEX Bits



Part No.	Description	Qty	Price
B000897	5 x 30mm	1	£1.14
B751308	5 x 75mm	1	£1.73
B000896	6 x 30mm	1	£1.14
B751316	6 x 75mm	1	£1.73
B000895	7 x 30mm	1	£1.14
B115546	7 x 75mm	1	£1.73
B000894	8 x 30mm	1	£1.14
B751324	8 x 75mm	1	£1.76
B000899	10 x 30mm	1	£1.21
B751332	10 x 75mm	1	£1.76
B000898	12 x 30mm	1	£1.21
B115547	12 x 75mm	1	£1.87

1/4" Drive HEX Bits



Part No.	Description	Qty	Price
B934586-5	2 x 25mm	5	£3.54
B934587-5	2.5 x 25mm	5	£3.70
B070289-5	3 x 25mm	5	£3.70
B070297-5	4 x 25mm	5	£3.70
B070300-5	5 x 25mm	5	£3.70
B070319-5	6 x 25mm	5	£3.70
B070327-5	8 x 25mm	5	£12.19

1/4" Drive Torx Bits L25mm



Part No.	Description	Qty	Price
B405138	TX15 x 25 Torx Bit	5	£4.67
B405139	TX20 x 25 Torx Bit	5	£4.67
B405142	TX25 x 25 Torx Bit	5	£4.67
B405143	TX30 x 25 Torx Bit	5	£4.67
B405144	TX40 x 25 Torx Bit	5	£4.67

10mm Drive TX Bits



Part No.	Description	Qty	Price
B000890	TX20 x 30mm	1	£1.00
B000889	TX20 x 75mm	1	£1.62
B000888	TX25 x 30mm	1	£1.03
B000887	TX25 x 75mm	1	£1.62
B011591	TX27 x 30mm	1	£1.09
B000886	TX30 x 30mm	1	£1.18
B000885	TX30 x 75mm	1	£1.62
B000884	TX40 x 30mm	1	£1.18
B000883	TX40 x 75mm	1	£1.62
B000882	TX45 x 30mm	1	£1.18
B000881	TX45 x 75mm	1	£1.62
B000879	TX50 x 30mm	1	£1.18
B000878	TX50 x 75mm	1	£3.47
B000877	TX55 x 30mm	1	£1.18
B000875	TX55 x 75mm	1	£2.51
B000874	TX60 x 30mm	1	£1.62
B000873	TX60 x 75mm	1	£1.56

1/4" Drive TX Bits



Part No.	Description	Qty	Price
B132225-5	TX6 x 25mm	5	£4.74
B132224-5	TX7 x 25mm	5	£4.98
B132222-5	TX8 x 25mm	5	£4.98
B739219-5	TX9 x 25mm	5	£5.46
B261815-10	TX10 x 25mm	10	£10.43
B029164-5	TX10 x 70mm	5	£24.66
B288551-10	TX15 x 25mm	10	£10.43
B029167-5	TX15 x 70mm	5	£24.66
B246999-10	TX20 x 25mm	10	£10.91
B771589-5	TX20 x 70mm	5	£24.66
B247006-10	TX25 x 25mm	10	£10.91
B029171-5	TX25 x 70mm	5	£24.66
B755788	TX25 x 110mm	1	£8.06
B274224-10	TX27 x 25mm	10	£10.91
B771600-5	TX27 x 70mm	5	£15.41
B261840-10	TX30 x 25mm	10	£10.91
B029175-5	TX30 x 70mm	5	£24.66
B261858-10	TX40 x 25mm	10	£10.91
B934637-5	TX40 x 70mm	5	£24.66

1/4" Dr Pozzi Bits



Part No.	Description	Qty	Price
B051098-10	PZ1 x 25mm	10	£8.06
B934569-5	PZ1 x 70mm	5	£24.42
B934570	PZ1 x 90mm	1	£5.93
B051101-10	PZ2 x 25mm	10	£15.18
210274	PZ2 x 50mm	2	£7.65
B934572-5	PZ2 x 70mm	5	£24.42
B934573	PZ2 x 90mm	1	£6.50
B887463	PZ2 x 110mm	1	£7.63
B119301	PZ2 x 120mm	1	£11.10
210248	PZ3 x 25mm	5	£4.65
B118052-10	PZ3 x 25mm	10	£10.43
210254	PZ3 x 50mm	2	£6.19
B934576-5	PZ3 x 70mm	5	£24.42
B934578	PZ3 x 110mm	1	£6.73

Flexible Screwdrivers



- Flexible shaft with integrated jaw
- Handle is highly resistant to vehicle-specific liquids, such as petrol, diesel, (mineral) oils and brake fluid
- 2-component plastic handle provides better grip and good power transmission

Part No.	Description	Qty	Price
B218493	5 x 150mm	1	£10.87
B218494	6 x 150mm	1	£10.14
B218495	7 x 150mm	1	£12.68
B218496	8 x 150mm	1	£12.93

Philips Heavy Duty Screwdriver with Striking Cap



- The handle is highly resistant to vehicle-specific liquids, such as petrol, diesel, (mineral) oils and brake fluid
- Equipped with special impact cap with "Force" connection

Part No.	Description	Qty	Price
B218384	PH1 x 80mm	1	£6.24
B218385	PH2 x 100mm	1	£6.42
B218386	PH3 x 150mm	1	£9.41
B218387	PH4 x 200mm	1	£13.62

Pozi Heavy Duty Screwdriver with Striking Cap



- The handle is highly resistant to vehicle-specific liquids, such as petrol, diesel, (mineral) oils and brake fluid
- Equipped with special impact cap with "Force" connection

Part No.	Description	Qty	Price
B218388	PZ1 x 80mm	1	£6.26
B218389	PZ2 x 100mm	1	£7.78
B218390	PZ3 x 150mm	1	£8.73
B218391	PZ4 x 200mm	1	£12.86

Philips PREMIUMline Screwdriver



- Handle is highly resistant to vehicle-specific liquids, such as petrol, diesel, (mineral) oils and brake fluid
- 2-component plastic handle provides better grip and good power transmission

Part No.	Description	Qty	Price
B218408	PH1 x 80mm	1	£4.13
B218409	PH2 x 100mm	1	£5.41
B218410	PH3 x 150mm	1	£6.99
B218411	PH4 x 200mm	1	£10.31

Plain Slot Heavy Duty Screwdriver with Striking Cap



- The handle is highly resistant to vehicle-specific liquids, such as petrol, diesel, (mineral) oils and brake fluid
- Equipped with special impact cap with "Force" connection

Part No.	Description	Qty	Price
B218376	3.5 x 75mm	1	£5.28
B218377	4.5 x 90mm	1	£6.02
B218378	5.5 x 100mm	1	£6.42
B218379	7 x 125mm	1	£9.26
B218380	8 x 150mm	1	£10.36
B218381	10 x 175mm	1	£13.20
B218382	12 x 200mm	1	£14.18
B218383	14 x 250mm	1	£14.62

1/4" Dr Screwdriver



£1.69

Part No. B172724

Pozi PREMIUMline Screwdriver



- The handle is highly resistant to vehicle-specific liquids, such as petrol, diesel, (mineral) oils and brake fluid
- 2-component plastic handle provides better grip and good power transmission

Part No.	Description	Qty	Price
B218412	PZ1 x 80mm	1	£4.07
B218414	PZ2 x 100mm	1	£4.80
B218415	PZ3 x 150mm	1	£7.12
B218416	PZ4 x 200mm	1	£9.53

Plain Slot TOPline Screwdriver



- The handle is highly resistant to vehicle-specific liquids, such as petrol, diesel, (mineral) oils and brake fluid
- High-quality round blade made of steel type 54SiCrV6, chrome-plated and the tip is provided with a special coating for an optimal fit and good protection against corrosion

Part No.	Description	Qty	Price
B218426	2.5 x 75mm	1	£2.59
B218427	3 x 75mm	1	£2.67
B218428	3.5 x 100mm	1	£2.71
B218429	4 x 100mm	1	£2.71
B218430	4 x 150mm	1	£4.07
B218431	4 x 360mm	1	£6.18
B218432	5 x 150mm	1	£3.80
B218433	5.5 x 125mm	1	£3.89
B218434	5.5 x 300mm	1	£5.60
B218435	6.5 x 150mm	1	£3.59
B218436	7 x 150mm	1	£4.04
B218437	8 x 175mm	1	£5.56
B218438	10 x 200mm	1	£6.58
B218439	12 x 250mm	1	£7.66

Plain Slot PREMIUMline Screwdriver



- The handle is highly resistant to vehicle-specific liquids, such as petrol, diesel, (mineral) oils and brake fluid
- Chrome-plated, satin-finished shaft for protection against corrosion

Part No.	Description	Qty	Price
B218400	3.5 x 75mm	1	£3.45
B218401	4.5 x 90mm	1	£3.80
B218402	5.5 x 100mm	1	£3.95
B218403	6.5 x 125mm	1	£4.41
B218404	8 x 150mm	1	£5.63
B218405	10 x 175mm	1	£7.87
B218406	12 x 200mm	1	£8.97
B218407	14 x 250mm	1	£10.79

TX Screwdriver



- The handle is highly resistant to vehicle-specific liquids, such as petrol, diesel, (mineral) oils and brake fluid
- High-quality round blade made of steel type 54SiCrV6, chrome-plated and the tip is provided with a special coating for an optimal fit and good protection against corrosion

Part No.	Description	Qty	Price
B218449	TX5 L50mm	1	£2.90
B218450	TX6 L50mm	1	£3.27
B218451	TX7 L50mm	1	£3.32
B140323	TX8 L145mm	1	£3.32
B218452	TX8 L60mm	1	£3.37
B218453	TX9 L60mm	1	£3.41
B218454	TX10 L80mm	1	£3.43
B218455	TX15 L80mm	1	£3.53
B218456	TX20 L100mm	1	£3.58
B218457	TX25 L100mm	1	£3.64
B218458	TX27 L115mm	1	£4.06
B218459	TX30 L230mm	1	£4.25
B218460	TX40 L130mm	1	£4.31

R-TX Security Screwdriver



- The handle is highly resistant to vehicle-specific liquids, such as petrol, diesel, (mineral) oils and brake fluid
- High-quality round blade made of steel type 54SiCrV6, chrome-plated and the tip is provided with a special coating for an optimal fit and good protection against corrosion

Part No.	Description	Qty	Price
B218461	R-TX9 L60mm	1	£4.82
B051937	R-TX10 L80mm	1	£5.24
B051938	R-TX15 L80mm	1	£5.47
B218464	R-TX20 L100mm	1	£5.62
B218470	R-TX20 L260mm	1	£6.52
B218465	R-TX25 L100mm	1	£5.65
B218471	R-TX25 L260mm	1	£8.72
B140352	R-TX27 L210mm	1	£6.14
B051941	R-TX30 L115mm	1	£8.15
B218472	R-TX30 L260mm	1	£9.33
B140354	R-TX40 L130mm	1	£8.09
B218469	R-TX45 L130mm	1	£8.14

VDE Plain Slot Screwdriver



- For safe working under electrical voltage (up to AC 1,000V and up to D S and IEC standard)
- High-quality blade made of chrome vanadium steel

Part No.	Description	Qty	Price
B218516	2.5 x 75mm	1	£2.63
B218517	3 x 75mm	1	£2.77
B218518	3 x 100mm	1	£2.90
B218519	3.5 x 100mm	1	£3.09
B218520	4 x 100mm	1	£3.73
B218521	5.5 x 125mm	1	£4.61
B218522	6.5 x 150mm	1	£5.42
B218523	8 x 175mm	1	£5.50
B218524	10 x 200mm	1	£7.89

VDE Philips Screwdriver



- For safe working under electrical voltage (up to AC 1,000V and up to DC 1,500V)
- Insulation according to standard EN 60900
- Approved in accordance with GS and IEC standard
- High-quality blade made of chrome vanadium steel

Part No.	Description	Qty	Price
B218525	PH0 x 60mm	1	£3.12
B218526	PH1 x 80mm	1	£3.95
B218527	PH2 x 100mm	1	£6.26
B218528	PH3 x 150mm	1	£6.35

Short Pozi Screwdriver



- High-quality hexagonal blade made of steel type 54SiCrV6, is matt chrome-plated and the tip is provided with a special coating for an optimal fit and good protection against corrosion
- The handle is highly resistant to vehicle-specific liquids, such as petrol, diesel, (mineral) oils and brake fluid

Part No.	Description	Qty	Price
B218422	PZ1 x 30mm Screwdriver	1	£2.98
B218423	PZ2 x 30mm Screwdriver	1	£3.59

MEGAPRO Screwdrivers



- Quick selection of the bits through extendable bit magazine equipped with 1/4" standard bits
- Robust 2-component handle with studs for good grip
- Weatherproof stainless steel shaft with magnetic bit holder

Part No.	Description	Qty	Price
1	B188124 220mm 12 in 1	1	£36.33
2	B188125 118mm 6 in 1	1	£11.65

7pc Heavy Duty PH and Slotted Screwdriver Set With Striking Cap



Set contains 1x of the following:

- PH1 x 80mm
- PH2 x 100mm
- PH3 x 150mm
- ZS 4.5 x 90mm
- ZS 5.5 x 100mm
- ZS 7 x 125mm
- ZS 8 x 150mm

£67.45

Part No. B240279

7pc PH/SL Screwdriver Set



Set contains x1 of the following:

- PH1 x 80mm
- PH2 x 100mm
- PH3 x 150mm
- ZS 3.5 X 75mm
- ZS 5.5 X 100mm
- ZS 6.5 X 125mm
- ZS 8.0 X 150mm

£44.66

Part No. B240287

8pc H/D PH/SL/PZ Screwdriver Set With Striking Cap

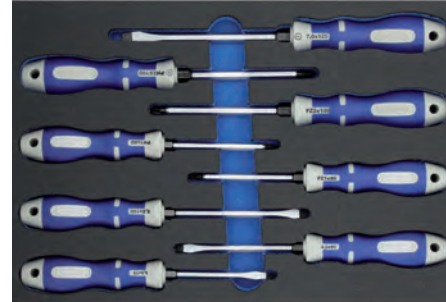

Set contains x1 of the following:

- PH1 x 80mm
- PH2 x 100mm
- PZ1 x 80mm
- PZ2 x 100mm
- SL 3.5 x 75mm
- SL 4.5 x 90mm
- SL 5.5 x 100mm
- SL 7.0 x 125mm

£50.41

Part No. B240282

8pc TX Screwdriver Set



Set contains x1 of the following:

- TX8 x 60
- TX10 x 80
- TX15 x 80
- TX20 x 100
- TX25 x 100
- TX27 x 115
- TX30 x 115
- TX40 x 130

£42.83

Part No. B240293

7pc R-TX Security Screwdriver Set

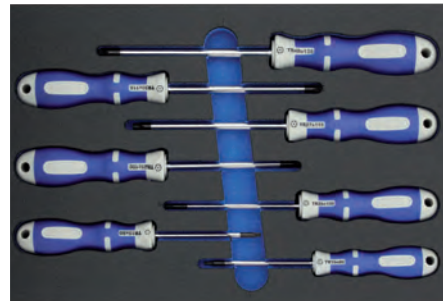

Set contains x1 of the following:

- R-TX 10 x 80
- R-TX 15 x 80
- R-TX 20 x 100
- R-TX 25 x 100
- R-TX 27 x 115
- R-TX 30 x 115
- R-TX 40 x 130

£56.71

Part No. B240298

8pc TX Screwdriver Set



Set contains x1 of the following:

- TX8 x 60
- TX10 x 80
- TX15 x 80
- TX20 x 100
- TX25 x 100
- TX27 x 115
- TX30 x 115
- TX40 x 130

£26.22

Part No. B240294

Club Hammer



- Head: Forged from steel in a mould and therefore a higher quality tempering than prescribed by the DIN standard. Tempered and painted black
- Hammer eye 30 HRC
- Lane hardened 50-58 HRC
- Fine round polished with durable bevel of 45°

Part No.	Description	Qty	Price
B244599	1kg	1	£14.52
B244601	1.25kg	1	£17.46
B244602	1.5kg	1	£18.91
B244603	2kg	1	£20.37

Rubber Hammer



- For use to fit sensitive components without damaging them
- Head DIN 5128

Part No.	Description	Qty	Price
B244629	240g	1	£7.85
B244630	480g	1	£13.64
B244631	680g	1	£15.40
B244632	1.5kg	1	£22.51

Plastic Hammer



- Plastic prevents damage and deformation of sensitive materials and parts during machining
- High-quality, robust plastic impact sockets. Easy to replace

Part No.	Description	Qty	Price
B244612	140g	1	£7.05
B244613	235g	1	£10.36
B068659	350g	1	£10.84
B031516	440g	1	£11.23
B244616	630g	1	£15.92
B588024	980g	1	£21.04

TOPLine Bench Hammer



- Fine round polished 45° chamfered forged steel head finished with a hardened and black lacquer
- The eye is sealed with a special resin in order to prevent the drying out of the shaft

Part No.	Description	Qty	Price
B244497	100g	1	£11.79
B244578	200g	1	£13.28
B244579	300g	1	£15.05
B244580	400g	1	£17.14
B244581	500g	1	£19.22
B244582	600g	1	£20.68
B244583	800g	1	£21.55
B244584	1000g	1	£25.50
B244585	1500g	1	£29.30
B244586	2000g	1	£34.12

Nylon Faced Dead Blow Hammer



- Prevents damage and deformation of sensitive materials and parts during machining and positioning
- Hammer head is partially filled with steel balls to absorb kickback

Part No.	Description	Qty	Price
B244622	600g	1	£24.05
B244623	700g	1	£28.37
B244624	800g	1	£33.47
B244625	1005g	1	£54.03
B244626	1800g	1	£80.11

Sledge Hammers



- Hammer Eye 30 HRC
- European, moisture controlled Ash handle
- Head: Die forged steel, quenched to a greater extent than that required by DIN standards
- Ring wedge and countersunk head combine the head and the shaft into one single component minimising tolerances and increasing stability
- Bahn hardened 50-58 RHc
- Chamfer from 45°
- Head: DIN6475
- Shaft: DIN5135

Part No.	Description	Qty	Price
B244604	3kg	1	£10.10
B244605	5kg	1	£37.31

View our latest product videos on our YouTube channel or online at unitedindustrial.co.uk

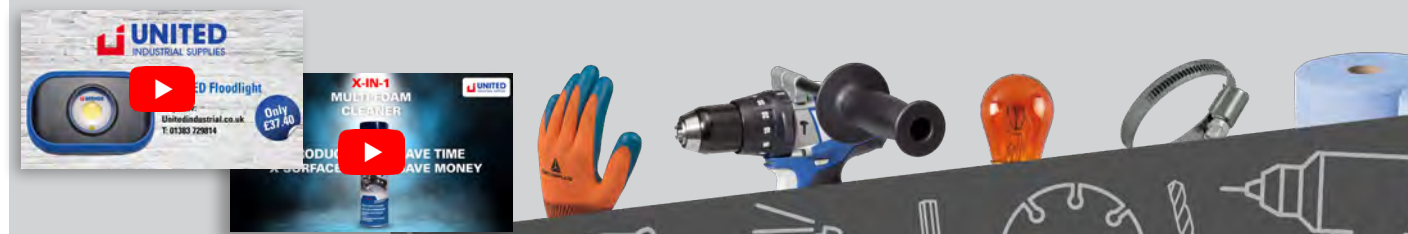

Graphite Ball Pein Hammers



LIFETIME GUARANTEE*

- Manufactured from drop-forged carbon steel
- Graphite core for improved strength and durability
- Textured rubber grip for secure handling
- Manufactured and tested to BS 876

Part No.	Weight	Qty	Price
BPHG16	16oz	1	£15.67
BPHG24	24oz	1	£18.59
BPHG32	32oz	1	£21.22

4oz (110g) Ball Pein Hammer



- Drop-forged carbon steel head
- Induction hardened and tempered with polished face and cheek
- Fitted with straight grain hickory shaft
- Manufactured and tested to BS 876

£8.68

Part No. 839236

2lb (900g) Ball Pein Hammer



- One of a comprehensive range of Premier Hand Tools, suitable for daily professional use
- Drop-forged steel head and fitted with straight-grained hickory shaft
- Manufactured in accordance with BS 876

£22.68

Part No. 839228

4oz (110g) Cross Pein Hammer



- Drop-forged carbon steel head
- Induction hardened and tempered with polished face and cheek
- Fitted with straight grain hickory shaft
- Manufactured and approved to BS 876

£10.44

Part No. 839246

4lb Club Hammer Fibreglass Shaft



LIFETIME GUARANTEE*

- Drop-forged carbon steel head
- Fitted with fibreglass shaft
- Contoured shock-absorbing rubber grip
- Manufactured in accordance with BS 876

£23.95

Part No. CHF401

4lb Club Hammer



LIFETIME GUARANTEE*

- Forged carbon steel head
- Quality hardwood shaft

£19.95

Part No. S0608

14lb (6.3kg) Hickory Sledge Hammer



- 90cm allows for a greater striking force
- Polished striking face with chamfered edges to avoid chipping

£48.42

Part No. 839265

Sledge Hammer with Fiberglass Shaft



- Manufactured from fine grained carbon steel
- Heat treated, induction-hardened and tempered with precision ground polished striking face
- Fitted with fibreglass shaft and contoured shock-absorbing rubber grip
- Manufactured in accordance with BS 876

Part No.	Weight	Qty	Price
SLHF101	10lb	1	£53.95
SLHF141	14lb	1	£64.85

4lb Sledge Hammer with Fibreglass Shaft Short Handle



- Manufactured from drop-forged fine grained carbon steel
- Heat treated, hardened and tempered with precision ground polished striking face
- Domed strike zone for power and efficiency
- Fibreglass shaft with graphite core for improved strength and durability
- Manufactured and tested to BS 876

£33.84

Part No. SLHG04

Hammer Handles



- According to DIN 5111
- Ash wood handle from certified European construction

Part No.	Description	Qty	Price
B249717	100g 260mm	1	£2.17
B249655	200g 280mm	1	£2.26
B249656	320g 300mm	1	£2.45
B249657	400g 310mm	1	£2.45
B249658	500g 320mm	1	£2.71
B249659	600g 330mm	1	£2.97
B249660	800g 350mm	1	£3.07
B249661	1000g 360mm	1	£3.70
B249664	1250g 260mm	1	£4.15
B249665	1500g 280mm	1	£4.19
B249662	1500g 380mm	1	£3.83
B249666	2000g 300mm	1	£4.20
B249663	2000g 400mm	1	£3.96
B249667	3000g 600mm	1	£8.47
B249668	5000g 800mm	1	£8.83

Sledge Hammer Handles



- According to DIN 5115
- Ash wood handle from certified European construction

Part No.	Description	Qty	Price
B249670	1500g 600mm	1	£9.93
B249671	2000g 600mm	1	£9.93
B249672	3000g 900mm	1	£16.51
B249673	5000g 900mm	1	£19.83
B249674	10000g 900mm	1	£20.64

14" Engineers Hammer Shaft



£3.68

Part No. 552334

3pc Sledge Hammer Wedges



£2.35

Part No. 552364

Round Hammer Wedges



- Thanks to the round hammer wedge, the head and the handle form a single unit
- The hammer handle does not split due to even and circular distribution of the mechanical stress
- 2 step wedge for a good grip
- For bench hammer, hand hammer and sledge hammer

Part No.	Description	Qty	Price
B249675	100g	1	£0.23
B249676	200g	1	£0.23
B249677	300g	1	£0.28
B249678	400g	1	£0.34
B249679	500g	1	£0.34
B249680	600g	1	£0.36
B249682	1000g	1	£0.36
B249683	1500g	1	£0.51
B249684	2000g	1	£0.51
B249687	3000g	1	£0.80
B249693	5000g	1	£0.56
B249694	10000g	1	£0.59

Janitorial

Our range of janitorial products include hand care, paper hand towels, toilet rolls, buckets, brooms and mops as well as washroom, floorcare and housekeeping chemicals

SEE PAGES 220-227

unitedindustrial.co.uk



Pin Punches



- DIN 6450
- Polished Pin

Part No.	Description	Qty	Price
B372274	2 x 150mm	1	£4.75
B372275	3 x 150mm	1	£4.75
B372276	4 x 150mm	1	£4.75
B372278	4 x 175mm	1	£5.05
B372290	4 x 205mm	1	£9.38
B372279	5 x 150mm	1	£4.75
B372292	5.5 x 205mm	1	£9.45
B068446	6 x 150mm	1	£4.75
B372280	6 x 175mm	1	£6.83
B372291	6 x 205mm	1	£9.55
B134995	7 x 150mm	1	£4.87
B068454	8 x 150mm	1	£5.02
B372284	10 x 150mm	1	£5.05

Drift Punch



- DIN 64458

Part No.	Description	Qty	Price
B372223	1 x 120mm	1	£3.55
B068314	2 x 120mm	1	£3.55
B372225	3 x 120mm	1	£3.55
B068330	4 x 120mm	1	£3.55
B372227	5 x 120mm	1	£3.55
B068357	6 x 120mm	1	£3.55
B372229	8 x 120mm	1	£5.16
B372230	9 x 120mm	1	£5.16
B372231	10 x 120mm	1	£5.16

12 x 120mm Centre Punch



- DIN 7250

£2.71

Part No. B372243

Cold Chisels



Part No.	Description	Qty	Price
B372162	100 x 15mm	1	£5.24
B372163	125 x 18mm	1	£5.38
B372164	150 x 18mm	1	£5.61
B372165	175 x 21mm	1	£7.65
B372166	200 x 24mm	1	£7.81
B372167	250 x 25mm	1	£8.73
B372168	300 x 26mm	1	£11.83
B372169	400 x 27mm	1	£15.83

Electrical

Our extensive range of electrical assembly products include cable ties, fuses, terminals, heat shrink tubing, connectors, auto cable, relays, cable lugs, battery terminals and batteries

SEE PAGES 6-18

unitedindustrial.co.uk

6pc Punch Set



Contents

- 150 x 3 x 10mm Pin Punch
- 150 x 4 x 10mm Pin Punch
- 150 x 5 x 10mm Pin Punch
- 150 x 6 x 10mm Pin Punch
- 175 x 4 x 10mm Pin Punch
- 175 x 4 x 10mm Pin Punch with Pin

£26.31

Part No. B372286

8pc Striking Tool Set



Contents

- Topline hammer 500g
- Plastic hammer 350g
- 200x24mm cold chisel
- Prick punch, 8-edged, 12mm x 120mm
- 3mm Pin Punch
- 4mm Pin Punch
- 5mm Pin Punch
- 6mm Pin Punch

£57.95

Part No. B039716

Light Trade Bench Vices



- EN9 Steel Jaws
- 1 Tonne clamping capacity
- Multi-purpose ideal for various light trade duties
- Roll threaded for fluid tightening and loosening motion
- Featuring robust anvil working surface
- Pre-drilled holes for bench mounting
- Cast iron body

Part No.	Size	Dimensions	Jaw Width	Jaw Opening	Weight	Qty	Price
839500	4"	280 x 140 x 155mm	100mm	100mm	7.5kg	1	£59.40
839502	5"	350 x 165 x 170mm	135mm	125mm	12kg	1	£93.85
839504	6"	370 x 171 x 175mm	155mm	150mm	13.5kg	1	£118.68

Quick Release Clamp



- High clamping force due to lever transmission
- Easy to relax with 1 finger
- Impact-resistant 2K plastic version
- Ergonomically shaped handles with soft plastic
- Easy to convert into a spreader
- Large clamping jaws prevent damage to the workpiece
- Cross holder makes it possible to connect clamps to each other

Part No.	Description	Qty	Price
B198703	0-150mm	1	£19.76
B198702	0-300mm	1	£19.72
B198701	0-450mm	1	£21.16
B198700	0-600mm	1	£25.16
B198699	0-900mm	1	£27.23

Heavy Duty Clamp



- Very high clamping force
- Improved workpiece adjustment and parallel contact pressure
- Special spring mechanism in the vice
- Easy to relax with one finger
- Special release lever
- Stable, robust metal construction for high loads
- Protect the workpiece from damage
- Also suitable as a spreader clamp

Part No.	Description	Qty	Price
B198698	0-150mm	1	£29.36
B198697	0-300mm	1	£28.36
B198696	0-450mm	1	£29.03
B198695	0-600mm	1	£31.85
B198694	0-900mm	1	£44.15

Heavy Duty Bench Vices



- Complete with serrated jaws for easy gripping
- Smooth and fast operation with a robust lever and grey iron castings that are manufactured to resist distortion under pressure
- Ideal for workshops, machinery and engineering applications
- Pre-drilled holes for bench mounting
- Cast iron body

Part No.	Dimensions	Jaw Width	Jaw Opening	Weight	Qty	Price
839506	350 x 160 x 160mm	100mm	137mm	9.25kg	1	£89.10
839508	440 x 190 x 200mm	125mm	183mm	16kg	1	£122.36
839510	520 x 220 x 230mm	150mm	173mm	23.5kg	1	£175.82

All-steel Screw Clamp

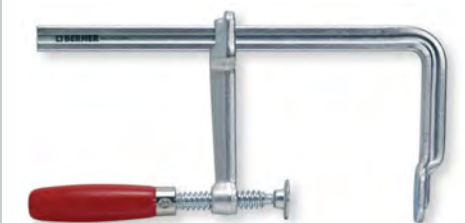

- Very strong and break resistant
- Fixed and sliding bars made of forged, annealed and galvanized special steel
- Ergonomically designed wooden handle
- High tension force
- Plastic layer over the wooden handle
- Black finished spindle

Part No.	Description	Qty	Price
B107643	0-160mm	1	£21.85
B107644	0-200mm	1	£28.81
B107645	0-250mm	1	£32.73
B107647	0-300mm	1	£46.34
B107648	0-400mm	1	£46.34
B107649	0-500mm	1	£52.25
B107650	0-600mm	1	£58.87
B107651	0-800mm	1	£88.95
B107652	0-1000mm	1	£76.62

Circlip Pliers External Straight Nose



Part No.	Description	Qty	Price
B001404	3-10mm	1	£14.37
B001405	10-25mm	1	£15.10
B001407	19-60mm	1	£17.41
B001408	40-100mm	1	£22.20
B001409	85-140mm	1	£25.40

Circlip Pliers Internal Straight Nose



Part No.	Description	Qty	Price
B001416	8-13mm	1	£15.99
B001417	12-25mm	1	£16.12
B001418	19-60mm	1	£17.41
B001420	40-100mm	1	£17.97
B001421	85-140mm	1	£26.41

Circlip Pliers External 90° Curved Nose



Part No.	Description	Qty	Price
B001410	3-10mm	1	£14.25
B001411	10-25mm	1	£14.56
B001412	19-60mm	1	£20.28
B001413	40-100mm	1	£20.41
B001415	85-140mm	1	£31.71

6pc Circlip Pliers Set



- Heavy internal and external locking ring pliers
- Ratchet locking system keeps the locking ring securely in place
- Curved points for easy access to the locking ring
- Very durable
- Well stored in a plastic case
- Contents : 3 pairs of curved points (Ø 2.75 mm, 0°, 45° and 90°)
- 3 pairs of curved points (Ø 3.0 mm, 0°, 45° and 90°)

£105.58

Part No. B174414

Diagonal Side Cutters



Part No.	Description	Qty	Price
B100520	145mm	1	£23.12
B100521	160mm	1	£19.90

End Cutting Pliers



Part No.	Description	Qty	Price
B100522	160mm	1	£18.22
B100523	200mm	1	£31.65

Heavy Duty Side Cutters



Part No.	Description	Qty	Price
B338076	180mm	1	£25.92
B100525	200mm	1	£30.70

One Hand Pipe Wrenches Steel



Part No.	Description	Qty	Price
B053557	350mm (0-48mm)	1	£62.39
B053558	450mm (0-60mm)	1	£50.05
B053559	600mm (0-76mm)	1	£72.19

Waterpump Quattro-Gripp Pliers



Part No.	Description	Qty	Price
B366861	180mm	1	£34.00
B338275	250mm	1	£36.65
B366862	300mm	1	£50.81
B366863	400mm	1	£81.31

Waterpump Pliers



Part No.	Description	Qty	Price
B119714	180mm	1	£14.95
B119717	240mm	1	£28.61
B119725	300mm	1	£29.07

Long Nose Pliers



Part No.	Description	Qty	Price
B100526	170mm	1	£19.13
B100529	205mm	1	£20.34

205mm 45° Angled Pliers



£22.77

Part No. B100527

160mm Flat Nose Pliers



£18.18

Part No. B100533

Combination Pliers



Part No.	Description	Qty	Price
B100531	165mm	1	£20.19
B100534	180mm	1	£21.60
B100535	205mm	1	£24.56

VDE Side Cutting Pliers



Part No.	Description	Qty	Price
B188083	145mm	1	£22.97
B188084	160mm	1	£28.74
B188086	180mm	1	£32.31

5 Piece VDE Plier Set



Set contains x1 of the following:

- Combi-Max 1000V 3k 180 mm
- Telephone pliers straight 1000V 3K 200 mm
- Telephone pliers curved 1000V 3K 205 mm
- Wire stripper 1000V 3K 160mm
- Diagonal cutter 1000V 3K 160mm

£122.78

Part No. B188103

230mm Scissors



£9.44

Part No. B406475

Hose Pinch Tool Set - 3-57mm



- For clamping flexible pipes: plumbing, oil lines, compressed air lines & fuel lines
- Quick & simple, one handed use

£33.09

Part No. B208128

6pc Circlip Pliers Set (Internal/External)



Set contains x1 of the following:

- Circlip pliers straight male thread 10-25mm
- Circlip pliers straight male thread 19-60mm
- Circlip pliers straight male thread 40-100mm
- Circlip pliers straight female thread 12-25mm
- Circlip pliers straight female thread 19-60mm
- Pipe wrench ClassicPlus 250
- Foam insert for sealer pliers

£99.36

Part No. B121460

5pc Pliers Set



Set contains x1 of the following:

- B100520 : 145mm Diagonal Side Cutter
- B100521 : 160mm Diagonal Side Cutter
- B100534 : 180mm Combination Pliers
- B100529 : 205mm Long Nose Pliers
- B366864 : 250mm Water Pump Pliers

£111.42

Part No. B003554

3pc Pliers Set



Set contains x1 of the following:

- B100521 : 160mm Diagonal Side Cutter
- B100529 : 205mm Long Nose Pliers
- B100534 : 180mm Combination Pliers

£65.41

Part No. B100542

Curved Jaw Locking Pliers



- Grips & holds easily, even in hard to reach areas
- High alloy steel

Part No.	Description	Qty	Price
B257737	7"	1	£15.18
B251453	10"	1	£16.98

Adjustable Locking Pliers



- Chrome plated body
- Large clamping area

Part No.	Description	Qty	Price
B43691	Regular	1	£50.52
B22356	Extra Deep	1	£53.20
B43692	Flexible Jaw	1	£38.21

Long Nose Pliers



- Grips & holds easily, even in hard to reach areas
- High alloy steel

Part No.	Description	Qty	Price
B48771	6" Long Nose Plier	1	£11.63
B251461	8" Long Nose Plier	1	£12.32

C-Clamp Locking Pliers

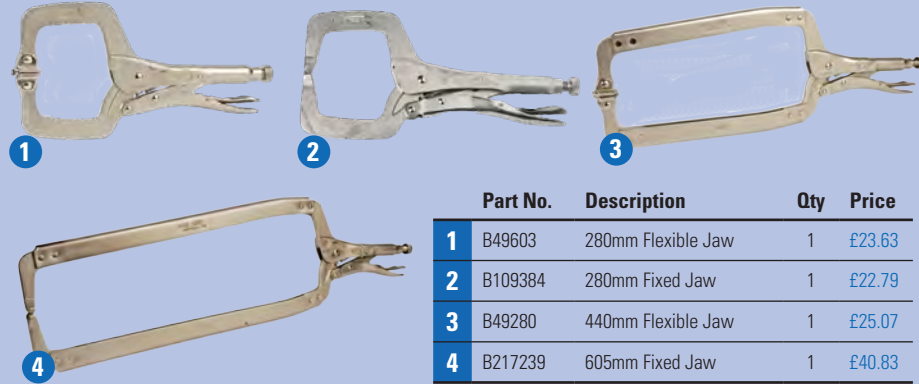

Part No.	Description	Qty	Price
1 B49603	280mm Flexible Jaw	1	£23.63
2 B109384	280mm Fixed Jaw	1	£22.79
3 B49280	440mm Flexible Jaw	1	£25.07
4 B217239	605mm Fixed Jaw	1	£40.83

3 point Locking Pliers



£10.00

Part No. B98891

222mm Welding Locking Pliers



£19.71

Part No. B251470

8" Sheet Metal Clamp Pliers



£21.52

Part No. B109385

Automatic Locking Pliers Easy Grip



Part No.	Description	Qty	Price
B36727	165mm	1	£24.89
B47599	195mm	1	£25.33
B36728	235mm	1	£29.03

193mm Locking Grip Pliers



Part No.	Description	Qty	Price
1 B42679	W-Tip Locking Grip	1	£26.69
2 B42683	L-Tip Locking Grip	1	£23.32

220mm Ratchet Crimping Tool (Insulated Terminals)



- Professional crimping tool for making good electrical connections
- Approved by SCM (Foundation for Certification of Vehicle Security)
- Suitable for insulated cable clamps from 0.5 - 6mm²

£28.37

Part No. B187739

205mm Dual Action Wire Stripper/Crimper



- A multi-purpose cable stripper for easy processing of electrical wire and cable lugs
- Stripping of rubber and PVC cables without damaging the inner cables from 0.13 - 6.0mm²
- Stripping in the middle of cables without damaging the inner cables of 0.5 - 6.0mm²
- Crimping insulated terminals 0.5 - 6.0mm²
- Crimping non-insulated cable lugs, 1.5 - 2.5mm² to 6.0mm² and 4

£21.76

Part No. B001191

DT Series Crimp Tool



- Tool that will apply the four crimp pattern around the contacts for Deutsch connectors

£168.82

Part No. 600618

220mm Ratchet Crimping Tool (Non-insulated Terminals)



- Professional crimping tool for making good electrical connections.
- Approved by SCM (Foundation for Certification of Vehicle Security)

£34.64

Part No. B724351

Heavy Duty Crimping Tool for Large Un-insulated Terminals



- Adjustable crimp for 10mm² to 120mm² cable

£192.98

Part No. 0-703-80

Scarab Quick Connector Disconnect Tool



- Quick connector pliers allow one handed operation in tight spaces
- Soft grip handle with finger operated levers
- Length: 120mm; Jaw width: 35mm
- Designed for 2 button style quick connectors used on automotive fuel, oil and coolant systems

£22.33

Part No. BT007826

200mm Wire Stripper



- Quick electrical wire stripping and cutting
- Automatic strips (short side) of 0.2 - 6.0mm²
- Stripping length is adjustable from 5 - 12mm
- Suitable for cutting electrical wire up to 2mm

£17.53

Part No. B012998

Copper Tube Terminal Crimping Tools



- For crimping press cable eyes and pipe cable plugs, but also cable eyes made of fine-wire conductors
- For solderless electrical connections according to DIN
- Works easily and effortlessly with optimal lever transmission

Part No.	Description	Qty	Price
514652	390mm (6 - 50mm ²)	1	£116.04
B167175	660mm (25 - 120 mm ²)	1	£348.99



Scraper



- Evenly ground edge
- Lacquered wooden handle with hanging eye

Part No.	Description	Qty	Price
B170852	30mm Scraper	1	£1.68
B170909	50mm Scraper	1	£1.98
B170925	80mm Scraper	1	£2.98

Wide Wall Scrapers



Part No.	Description	Qty	Price
DRAP67552	38mm	1	£6.64
838010	76mm	1	£5.32

50mm Wide Wall Scraper Soft Grip



- Fully polished bevelled steel blades, each precision ground
- Hardened and tempered and attached to a soft grip handle with hole to hang it up

£14.17

Part No. 839009

Window Scraper



- Very low risk of damage
- Includes one replaceable blade

Part No.	Description	Qty	Price
B103651	Scraper	1	£17.45
B372673	Replacement Blades	10	£4.26

Plastic Window Scraper



£2.94

Part No. 700063

Razor Blade Scraper



£17.95

Part No. AK52504

Straight Style Knife Blades Single Edge H/D



- Pack of 100
- 38mmx19mm

£16.32

Part No. 838373

Silver Pocket Size Safety Scraper

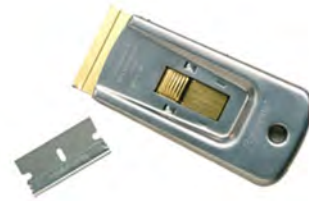

- Pocket size holder
- Blade retracts into holder for safety when not in use

Part No.	Description	Qty	Price
CD170	Scraper	1	£2.71
CD171	Replacement Blades	5	£3.30

Scraper and Knife Set



- To remove excess sealant and adhesive residues, badges etc
- Four different scraper blades
- Retractable knife with multi-stage locking function

Part No.	Description	Qty	Price
B47131	Scraper & Knife Set 27pc	10	£22.47
B372621	12mm Blades	10	£1.69
B372622	16mm Blades	10	£3.31
B372620	16mm Blades at 53°	1	£4.52
B372623	20mm Blades	10	£2.44

150mm Gasket Scraper



- For removing flat gaskets
- 2 component handle
- Total length: 260mm
- Scraper width: 24mm

£10.51

Part No. B341498

Retractable Metal Trimming Knife



- Die-cast handle
- Blade adjusts to four positions
- Spare blades can be stored in the handle
- Will use virtually any make of trimming knife blade available
- Heavy-duty knife blade included

Part No.	Description	Qty	Price
1	B38320 Retractable Metal Trimming Knife	1	£7.00
2	B857351-10 52 x 19mm Replacement Straight Blades	10	£1.47
3	B857327-10 69 x 19mm Replacement Straight Blades	10	£9.25
4	B857360-10 48 x 19mm Replacement Hooked Blades	10	£11.89

Cartridge Nipple/Nozzle Cutter

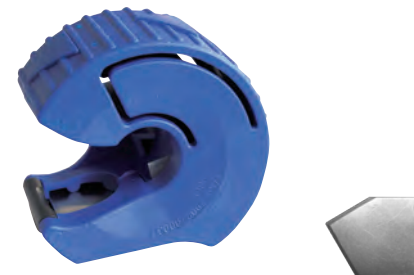

- For quick and safe cutting of nozzles
- Opening of sealant and adhesive cartridges

Part No.	Description	Qty	Price
B113209	Cutter	1	£3.89
B145178	Replacement Blades	1	£10.30

255mm Hose Cutter



- For cutting PA, PP, PE, PEX, PB and PVDF pipes up to Ø 28mm

Part No.	Description	Qty	Price
B113063	Cutter	1	£25.08
B145178	Replacement Blades	1	£10.30

Aluminium Blueline Extending Trimming Knife



- Easily cuts materials with high cutting pressure, such as rubber, soft plastic, silicone
- Ergonomic aluminium housing with rubber grip
- Fast blade change with quick change button
- Knife can be replaced without tools
- 4 blade knife magazine in handle
- Suitable for all common trapezoid blades

£7.80

Part No. B405741

Retractable Snap-Off Knife

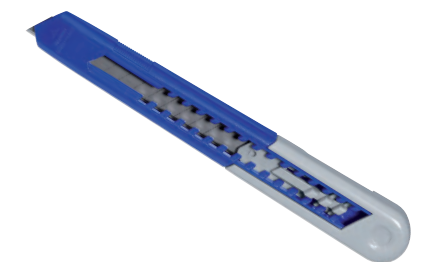

- Weather and impact resistant plastic
- With mounting clip and integrated lock
- Supplied with 1x blade

Part No.	Description	Qty	Price
B129874	9mm	1	£1.78
B129882	18mm	1	£2.12

Snap-Off Blades



- High-grade steel, cold-hardened
- Supplied in a handy dispenser

Part No.	Description	Qty	Price
B857378	9mm Snap-off Blades	10	£1.99
B857386	18mm Snap-Off Blades	10	£3.44
B147092	25mm Snap-Off Blades	10	£6.17

Straight Style Knife Blades H/D



£10.09

Part No. 838370

Retractable Knife 99E



£11.01

Part No. 838378

Folding Pocket Knife



Part No.	Description	Qty	Price
838386	Knife	1	£10.73
838388	Spare Blades	50	£27.53

General Purpose Shears



- Suitable for cutting of leather, cardboard, paper, fabric, rope, plastic, thin tin, flooring etc
- Serrated blade for ease of cutting
- Cutting edge length: 40mm

£11.66

Part No. B406478

12.7mm Rubber Tube Cutter



£8.45

Part No. 838433

Tinman's Shears



- For long straight cuts & wide curves
- Curved blades

Part No.	Description	Qty	Price
B131834	Right Cut	1	£32.11
B131835	Left Cut	1	£33.15

Bolt Cutters



- Suitable for cutting structural steel
- Forged and hardened blades - long lasting
- Maximum cutting capacity: steel of 140kg/mm2
- Rubber handle for firm grip

Part No.	Description	Qty	Price
B134997	450mm	1	£47.77
B134998	600mm	1	£70.05
B134999	750mm	1	£77.69
B135000	900mm	1	£112.63

Tin Snips



- Twin gear and curved blades
- Induction hardened cutting edges
- Cutting edges lightly grooved prevents the plate from slipping
- Self-opening through built-in spring with lock

Part No.	Description	Qty	Price
B049344	Right Cut	1	£28.23
B049360	Left Cut	1	£25.10

150mm Junior Hacksaw



- Stable bracket with plastic pistol grip
- Blades are easily removed and inserted by adjusting screw
- Designed for junior saws 150mm

£10.56

Part No. B339563

200mm Mini Hacksaw



- Blade Holder for hacksaw blades
- Metal body with rubber handle
- Ideal for hard to reach areas
- Complete with 300mm blade

£5.59

Part No. B50539

300mm Hacksaw Frame



- Bi-metal version with 2-component plastic coating
- Quick release clamping system incorporating rotary wheel and locking lever
- Complete with 300mm blade

£24.49

Part No. B173325

300mm Bi-Hard Cobalt Hacksaw Blades



- The toothing is optimally tempered, resulting in high cutting performance
- Suitable for use in confined spaces

Part No.	Description	Qty	Price
B189162	24 Teeth/Inch - 300mm	10	£8.44
B933826-10	32 Teeth/Inch - 300mm	10	£12.09

12 x 1/2 14-18 Variable tpi Bi-Metal Hacksaw Blades - Pack of 10



£20.63

Part No. 538228

6" Junior Hacksaw Blades



- Pack of 10

£2.04

Part No. 538503

300mm Super Flexible Hacksaw Blades



- The toothing is optimally tempered, resulting in high cutting performance
- Suitable for use in confined spaces

Part No.	Description	Qty	Price
B016087-10	18 Teeth/Inch - 300mm	10	£10.36
B046310-10	24 Teeth/Inch - 300mm	10	£9.85
B016086-10	32 Teeth/Inch - 300mm	10	£9.85

12 x 1/2 30 Hacksaw Blades



- M2 High Speed Cutting edge welded to Flexible Alloy Back
- Cuts Through Alloy and Stainless Steels

Part No.	Description	Qty	Price
538242	18 Teeth/Inch	10	£26.18
538218	18 Teeth/Inch	100	£112.07
538250	24 Teeth/Inch	10	£23.30
538258	32 Teeth/Inch	10	£23.19

Junior Metal Hacksaw Blades



- Accurate sawing in steel, metal, NF metals, thin-walled bar steel and pipe steel, sheets from a thickness of 1.2mm and chilled cast iron
- For use in junior saw frames

Part No.	Description	Qty	Price
B084703-10	14 Teeth/Inch - 150mm	10	£2.60
B046280-10	32 Teeth/Inch - 150mm	10	£2.92

12 x 1/2 Sandflex Hacksaw Blades



- Combines extreme cutting performance and wear resistance with a high degree of flexibility
- Shatterproof bi-metal blade

Part No.	Description	Qty	Price
680096	18 Teeth/Inch	10	£14.82
680102	24 Teeth/Inch	10	£13.21

Lighting

Within our lighting range we offer a wide selection of bulbs and fluorescent tubes as well as torches, work lamps and beacons for all your illumination needs

SEE PAGES 19-27

unitedindustrial.co.uk



Flat File



- Tooth size: second cut
- Plastic handle with hanging loop
- Hardness: 66 Rockwell

Part No.	Description	Qty	Price
B069507	200mm	1	£6.00
B069515	250mm	1	£6.86

Half Round File 250mm



- Tooth size: second cut
- Plastic handle with hanging loop
- Hardness: 66 Rockwell

Part No.	Description	Qty	Price
B069531	200mm	1	£7.16
B069540	250mm	1	£9.28

6pc Needle File Set L100mm



Set contains x1 of the following:

- 1x Flat
- 1x Tapered
- 1x Square
- 1x Round
- 1x Triangular
- 1x Half Round

£15.32

Part No. B149791

Round Files



- Tooth size: second cut
- Plastic handle with hanging loop
- Hardness: 66 Rockwell

Part No.	Description	Qty	Price
B030642	200mm	1	£6.20
B069558	250mm	1	£6.86

150mm Brake Shoe File



- For the removal of brake dust, rust and dirt around brake shoes
- Plastic handle with hanging loop

£10.07

Part No. B285811

230mm Thread File



- To repair and clean "ISO" metric threads
- For any "ISO" metric pitch thread (0.8 - 1 - 1.25 - 1.75 - 2 - 2.5 - 3mm)
- Suitable for internal or external thread

£43.98

Part No. B069922

Three Square Files



- Tooth size: second cut
- Plastic handle with hanging loop
- Hardness: 66 Rockwell

Part No.	Description	Qty	Price
B030641	200mm	1	£6.26
B069523	250mm	1	£6.29

Half Round Rasp File 250mm



- Tooth size: second cut
- Plastic handle with hanging loop
- Hardness: 66 Rockwell

£9.54

Part No. B107823

3pc Brake Caliper File Set



- Set includes caliper file square 9mm cut 1, caliper file flat 9mm cut 1, caliper file flat 12mm cut 2
- For cleaning brake caliper parts

£39.36

Part No. B121161

4pc File Set with Plastic Handles



Set contains x1 of the following

- Flat File 250mm second cut
- Half Round File 250mm second cut
- Three Square File 250mm second cut
- Round File 250mm second cut

£19.82

Part No. B279676

11pc File Set in Foam Insert



- Suitable for cutting of leather, cardboard, paper, fabric, rope, plastic, thin tin, flooring etc
- Serrated blade made of stainless steel tungsten
- Cutting edge length: 40mm

£56.80

Part No. B134335

2 Row Wire Scratch Brush



- Industrial quality brush suitable for a multitude of cleaning applications
- For use on metal, concrete, rust & paint

£1.47

Part No. 610293

4 Row Wire Scratch Brush



- Pack of 6
- Industrial quality brush suitable for a multitude of cleaning applications
- For use on metal, concrete, rust & paint

£7.11

Part No. 610278

4 Row H/D Wire Brush with Scraper



- Heavy duty 4 row wooden handled scratch brush fixed with a sturdy metal scraper for aggressive applications

£2.21

Part No. 610277

12mm Steel Brake Caliper Wire Brush



- For the cleaning of brake calipers
- Plastic handle
- Hardened steel wire
- Length: 225mm

£9.20

Part No. 200581

SPID Brushes Brass Plated Steel Wire



- Pack of 6

£16.83

Part No. VANWB19A

Battery Terminal Cleaning Brush



- Suitable for most standard 12 & 24 volt batteries
- Essential tool for maintaining for good electrical connections
- Plated metal construction

£6.52

Part No. BT005454

Universal Outside Thread Chaser



- Universal outside thread chaser to be used on shaft parts with external threads from 1.25" up to 5" outside diameter
- Quickly restores threads without the need for cutting, saving both time and money. Overall capacity 31.75mm - 127mm (1.25 inch - 5 inch)
- Includes 6 interchangeable pads for 24 different thread pitches, covering both metric & imperial
- Metric: 1, 1.25, 1.5, 1.75, 2, 2.5, 3, 3.5
- Threads per inch: 4, 5, 6, 7, 7.5, 8, 9, 10, 11, 11.5, 12, 14, 16, 18, 20, 24
- Replaceable V pad and dies available

£131.41

Part No. BT007798



Tape Measure



- High measurement precision
- Robust - fully rubberized plastic housing
- Kink length of the tape measure approx. 2m
- Nylon cover protects against wear and corrosion

Part No.	Description	Qty	Price
B097784	3m x 16mm	1	£3.07
B097785	5m x 19mm	1	£4.74
B097786	8m x 25mm	1	£8.46

Magnetic Double-sided Tape Measure



- High measurement precision - Accuracy class II on both sides
- Double-sided printed ribbon with magnet and double hook
- Robust, matt chrome-plated housing UV-resistant with black rubber

Part No.	Description	Qty	Price
B370497	3m x 16mm	1	£7.04
B370498	5m x 25mm	1	£12.27
B370499	8m x 25mm	1	£17.26

5m Tape Measure



- Locking mechanism
- Easy to read measurements
- Robust case with ribbed grip
- Fast return and release

£6.05
Part No. BT005913

300mm Metric and Imperial Combination Square



- Matt black metal stock with polished faces, brass adjusting screw, spirit level and scribe
- Aluminium blade graduated (on both sides of the blade) metric on one edge and imperial on the other

£23.52
Part No. DRAP34703

100mm Digital Brake Disc Caliper



- Hardened and tempered stainless steel gauge
- Metric or Imperial read-out with hold function
- Zero setting control allows for comparative measurement
- Includes serial port connection for computer interface
- Supplied in storage case

£91.69
Part No. VS0561

0 to 50mm Brake Disc Caliper



- Stainless steel
- Floating jaw assembly enables easy removal of caliper from disc while retaining reading
- Metric scale with 0.1mm graduations

£43.80
Part No. VS056

1.5V LR44 Alkaline Battery



- Pack of 6
- Suitable for electronic, medical, security devices & other portable electronic devices
- High capacity, non-rechargeable
- Wide temperature range
- Long storage life & long operational life

£5.19
Part No. 800222

Brake Disc Digital Gauge



- Measures in metric and imperial (0-6inch or 0-150mm)
- Data hold function
- Ideal for use by mechanics

£150.46
Part No. BT004584

Digital Vernier Caliper 150mm



- Equipped with LCD display and data output RS 232C
- Stainless steel version, with clamping screw
- Unit of measurement: mm and inch

£65.93
Part No. B169091

Vernier Gauge DIN862 0-150mm



- Stainless steel with time adjustment
- DIN 862
- Beak depth: 40mm
- Vernier: 0.05mm

£21.98
Part No. B161691

Digital Thermometer Thermo Control III



- Versatile - can be used anywhere
- With Data-hold function and auto power-off
- Equipped with backlit LCD display
- Built-in laser pointer for precise temperature measurement
- Select mode Celsius / Fahrenheit
- Housing made of impact resistant ABS plastic
- Carrying pouch for safe transport
- Compliant with IEC / EN 61010-1
- Includes 2 batteries 1.5V LR03 (AAA)
- Housing made of impact resistant and unbreakable ABS plastic

£118.49
Part No. B215517

Mini Digital Thermometer



- High precision digital thermometer with the sensor located in the tip of the stainless steel probe
- Compact and lightweight measuring both °C and °F with hold function
- Ideal for testing automotive air conditioning output

£18.31
Part No. VS906

Infrared Non-Contact Forehead Thermometer



- Designed to take a temperature with a 3-5cm distance from the forehead. It uses infrared technology to measure temperature and is quick and easy to use

£65.33
Part No. 810610

Digital Ammeter- Multimeter



- Suitable for measuring direct and alternating current, without interrupting the electrical circuit
- Easy to read thanks to extra large LCD display with large number display
- Equipped with diode tester (doorbell function)
- Low battery indication, TÜV/GS tested

£104.14
Part No. B43345

Anemometer



- Wind speed measuring device featuring live/ maximum/average/wind chill and Beaufort scale
- Ideal for checking workshop dust/fume extraction devices
- Also reads temperature which can be measured in either °C or °F
- Readings are displayed on a 24mm high back-lit LCD screen
- Features a battery indicator and auto/manual power off

£47.68
Part No. TA070

Pocket Domestic Thermometer



£8.48
Part No. 590352

Polar Master Anti-Freeze Tester

- Takes the accuracy of a laboratory to the vehicle
- Ensures accurate determination of % ethylene-glycol at any temperature, and indicates the amount of undiluted anti-freeze to add to obtain the correct degree of frost protection



£117.36
Part No. 486110

Multi Liquid Refractometer



- Accurately measures the strength of coolant, screen wash, battery fluid and AdBlue
- Supplied with pipette: result can be measured with one test drop
- Adjustable eyepiece
- Measurement range: -50 to 550°C

£72.12
Part No. B204773

Battery Fluid Hydrometer



- Clearly readable scale with colour indication
- Low suction volume necessary
- Sturdy construction with plastic cylinder
- Large, centred plastic weight
- Obliquely prevents contraction of the acid column

£11.78
Part No. B140092

Brake Fluid Tester



- Quick and simple to use
- Compact and portable
- User-friendly
- Measurement spotlight
- Resistant to acid and alkali
- Tested in accordance with IEC/EN 61010-1 (DIN VDE 0411)

£45.95
Part No. B215220

Blind Ratchet Rivet Nut Tool

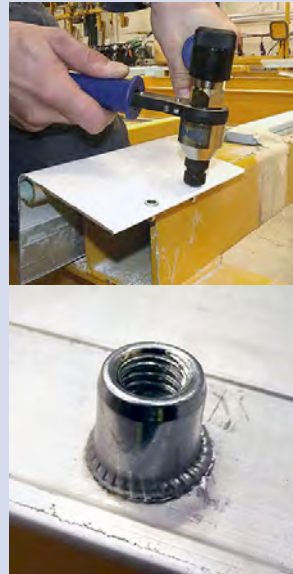

- For processing blind rivet nuts M5 to M12 and blind rivet bolts M5 to M8
- Minimum effort due to built-in ratchet function
- Saves time when changing threaded mandrel and threaded sleeve by a special fast change system

£197.02

Part No. B024813

Blind Rivet Pliers



- For processing blind rivets Ø 2.4 to 5.0 mm
- Professional hand pliers with swivel head 360°
- Excellent for processing blind rivets in hard-to-reach places
- Automatic ejection of residual nail

£29.00

Part No. B787914

600g Magnetic Pick-Up Tool



- Extendable telescopic handle with magnet
- Handy pen format with clip
- Integrated needle for adjusting windscreen washers
- Includes protective cap and overall clip

£11.80

Part No. B124576

Heavy-Duty Wiper Arm Puller



SAVES THE PRICE OF A NEW WINDSCREEN

- Heavy-duty construction with locking feature allowing the tool to be fastened securely to the wiper arm before commencing pull
- Also suitable for battery terminal and alternator bearing removal

£20.95

Part No. VS807

4pc Miniature Hook & Pick Set



- Straight, Right Angle, Half-Round, Swan Neck
- Chrome finish shafts with knurling for fingertip precision
- Suitable for removal of bushings, cotter pins, O-rings and seals
- Lifetime guarantee

£12.74

Part No. AK5214

Blind Rivet Nut Pliers



- Compact, handy and adjustable
- For processing nutserts Ø M3 - M6, Ø M4 - M5: aluminum steel and stainless steel, Ø M6: aluminium

£43.02

Part No. B124609

Heavy Duty Pop Rivet Pliers

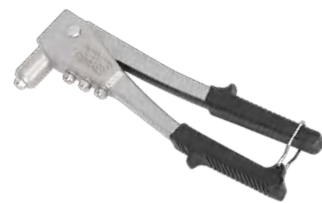

- Drop-forged aluminium body with heavy-duty SCM4 grade jaws, carbon steel jaw case and pin
- Supplied with four rivet nozzles and nozzle spanner

£19.92

Part No. 462278

Lazy Tongs Riveter



- Supplied with five nozzles (2.5, 3.2, 4, 4.8 & 6.4mm)
- Aluminium head with steel jaw case and 3-piece jaws for aluminium, steel and stainless steel rivets
- Suitable for repetitive riveting tasks
- Knurled nozzles for quick changing
- Lifetime guarantee

£79.95

Part No. AK399

Swivel Head Nut and Riveter Set



- 4x heads: 3.2, 4, 4.8 and 6.4mm
- Mandrills: M4, M5, M6, M8 and M10

£203.86

Part No. BT003597

- Unique design swivel head gives access to awkward fixings
- Long (350mm) steel tube handles with a rubber grip give extra power
- Overall length 570mm
- Suitable for use on aluminium rivets, steel rivets and nuts
- Unique alloy swivel head
- Supplied in a blow mould case

Heavy Duty Spiralux Lazy Tong Riveter Eclipse



- Supplied with three nozzles (3, 4 & 5mm)
- Suitable for repetitive riveting tasks
- Die-cast head with steel jaw
- Chrome Molybdenum jaws for aluminium, steel and stainless steel rivets

£100.74

Part No. 462283

Flexible Magnetic Pick-Up Tool



- Flexible magnetic lifter with powerful permanent magnet

Part No.	Description	Qty	Price
B304921	500g - L460mm	1	£12.12
B069825	1800g - L520mm	1	£18.66

500mm Flexible Gripper Pick-Up Tool



- Ergonomic handle shape to apply enough pressure
- Large retractable grab of up to 22 mm
- Hard-to-reach places become easily accessible
- Retractable grab

£19.86

Part No. B372754

B0601 Bohle Glass Sucker

- Pump-activated suction lifter made of sturdy aluminium with high load capacity for handling large objects
- Handle with non-slip coating
- Rounded pump tappet enables quick and easy operation and the red ring on the pump tappet enables permanent visual monitoring of the vacuum
- The suction lifter lends itself to all materials with flat, airtight surfaces. The high quality of the suction lifter has been confirmed by TÜV (German Technical Inspection Agency) by granting it the GS sign

- Load Capacity – 120kg
- Suction Pad – Ø213mm



£182.27

Part No. 810670

Windscreen products and wiper blades

SEE PAGES 258-259



8pc Screwdriver Set VDE Approved



- Fully insulated to VDE and EN 60900 standards
- Contents:**
- | Slotted | Phillips | Pozi |
|---------------|------------|--------------|
| • 3.5 x 100 | • #1 x 80 | • #1 x 80mm |
| • 4 x 100 | • #2 x 100 | • #2 x 100mm |
| • 5.5 x 125mm | | |
| • 6.5 x 150mm | | |

£21.75

Part No. AK6124

3pc Pliers Set VDE Approved



- Contents:**
- Long Nose Pliers 210mm/Ø1.8mm
 - Combination Pliers 180mm/Ø2mm
 - Side Cutters 160mm/Ø2mm

£51.94

Part No. AK83452

9pc TRX-Star* Key Set Extra-Long VDE Approved



- T10, T15, T20, T25, T27, T30, T40, T45 & T50 Keys (Length 135 - 215mm)
- Fitted with PP/TPR handles, keys are fully insulated to VDE and EN60900 standards
- Supplied in storage case

£41.37

Part No. AK7178

7pc Insulated Open-End Spanner Set VDE Approved



- 8, 10, 12, 13, 14, 17 & 19mm spanners
- Each spanner is fully insulated to VDE and EN 60900 standards to protect from electric shocks up to 1500V DC and 1000V AC
- Supplied in storage case

£95.94

Part No. AK63171

9pc Insulated Socket Set 3/8" Sq Dr 6pt WallDrive® VDE Approved



- 8, 10, 12, 13, 14, 17 & 19mm sockets
- Flip Reverse Comfort Grip Ratchet Wrench with Push-Button Quick Release
- 100mm Extension Bar

£128.64

Part No. AK7942

10pc Insulated Socket Set 1/2" Sq Dr 6pt WallDrive® VDE Approved



- 10, 12, 13, 14, 17, 19, 22 & 24mm sockets
- Flip Reverse Comfort Grip Ratchet Wrench with Push-Button Quick Release
- 125mm Extension Bar

£146.34

Part No. AK7943

Torque Wrench Insulated 3/8" Sq Dr



- Impact resistant polycarbonate tubing with nylon thermoplastic for total insulation
- Fully insulated to BS EN IEC 60900:2018 to protect from electric shocks up to 1500V DC and 1000V AC
- Calibration tolerance in accordance with BS EN ISO 6789:2017

Part No.	Description	Qty	Price
STW803	12-60Nm	1	£269.95
STW805	5-25Nm	1	£349.95

27pc 1000V Insulated Tool Kit VDE Approved

- Contents:**
- 8" Combination Pliers
 - 6" Diagonal Pliers
 - Open-End Spanners - 7, 8, 10, 12, 13, 14, 17, 19mm
 - Cable Knife
 - Slotted screwdrivers (4 x 100, 5.5 x 125mm)
 - Phillips screwdrivers (#1 x 100, 2 x 100mm)
 - 3/8" Sq Drive Reversible Ratchet
 - 3/8" Sq Drive 100mm Extension Bar
 - 3/8" Sq Drive Sockets (7, 8, 10, 12, 13, 14, 17, 19, 22mm)
 - 3/8" Sq Drive T-Handle
 - Each tool is fully insulated to VDE and EN60900 standards to protect from electric shocks up to 1500V DC and 1000V AC

£257.54

Part No. AK7945



VDE Approved 1000V Insulated Tool Kits



LIFETIME GUARANTEE



50pc 3/8" Sq Drive

- Contents:**
- 3/8" Sq Drive Sockets: 7, 8, 10, 11, 12, 13, 14, 15, 17, 19 & 22mm
 - Ratchet Wrench
 - Extension bars: 100, 200mm
 - Socket Bits: 4, 5, 6, 7, 8mm
 - T-Handle
 - Cable Knife
 - Voltage Tester
 - 150mm Diagonal Pliers
 - 175mm Combination Pliers
 - 200mm Long Nose Pliers
 - 250mm Water Pump Pliers
 - Open-End Wrenches: 8, 10, 12, 13, 14, 17, 19mm
 - Nut Drivers: 6 x 125, 7 x 125, 8 x 125, 10 x 125, 13 x 125mm
 - Slotted screwdrivers: 3 x 75, 5.5 x 125, 6.5 x 150
 - Phillips screwdrivers: #0 x 75, #1 x 100, #2 x 100mm
 - Hex Key Wrenches: 2.5, 3, 4, 5, 6, 8mm

£524.95

Part No. AK7938

49pc 1/2" Sq Drive

- Contents:**
- 1/2" Sq Drive Sockets: 10, 12, 13, 14, 16, 17, 18, 19, 22 & 24mm
 - Ratchet Wrench
 - Extension bars: 125, 250mm
 - Socket Bits: 5, 6, 7, 8, 10mm
 - T-Handle
 - Cable Knife
 - Voltage Tester
 - 150mm Diagonal Pliers
 - 175mm Combination Pliers
 - 200mm Long Nose Pliers
 - 250mm Water Pump Pliers
 - Open-End Wrenches: 8, 10, 12, 13, 14, 17, 19mm
 - Nut Drivers: 6 x 125, 7 x 125, 8 x 125, 10 x 125, 13 x 125mm
 - Slotted screwdrivers: 3 x 75, 5.5 x 125, 6.5 x 150
 - Phillips screwdrivers: #0 x 75, #1 x 100, #2 x 100mm
 - Hex Key Wrenches: 2.5, 3, 4, 5, 6, 8mm

£583.96

Part No. AK7939

Hybrid Workshop Tool Kit

Tools and equipment to enable technicians to carry out work on hybrid/ electric vehicles safely including:

- Red/White Post & Chain Kit 25m
- Keyring Warning Tag
- Warning Sign
- High Voltage Warning Sign 200 x 300mm
- High Voltage Rescue Pole
- Pneumatic Glove Tester
- Safety Gloves 1kV
- Insulating Rubber Safety Mat 1 x 1m
- Insulated Socket Set 9pc 3/8" Sq Dr 6pt VDE
- Screwdriver Set 8pc VDE Approved
- Pliers Set 3pc VDE
- Insulated Open-End Spanner Set 7pc VDE
- Digital Automotive Analyser/Insulation Tester

£1392.81

Part No. HP55KITCOMBO



Professional Gas/No-Gas MIG Welder 210Amp with Euro Torch



- A professional large gas/no-gas welder offering excellent performance at an extremely competitive price
- This unit is set up ready to go in gas mode but can also be switched easily to use gasless by a simple change of polarity
- Supplied with high quality cool running Ergo 15.2 Euro torch, 2m earth cable, 1.4m gas hose, twin gauged gas regulator and 0.6 & 0.8mm contact tips

£679.95

Part No. MIGHTYMIG210

Workshop Welding Curtain to BS EN 1598 & Frame 1.3 x 1.75m



- Amber welding screen manufactured to BS EN 1598
- Suitable for use in workshops where the glare from welding and cutting may be a hazard to others

£159.95

Part No. SSP99

Green Welding Gauntlets



£4.04

Part No. 564250

Flipfront Welding Goggles



£6.66

Part No. 816430

Gas Welding Goggles BS1542



£6.37

Part No. 580272

Red Welders Cat 2 Patch Palm Gauntlets



£6.83

Part No. 765348

Polycarbonate Coloured Face Screen Shade 5



Part No.	Description	Qty	Price
788944	Full Face Screen	1	£21.99
788942	Spare Shade 5 Visor	1	£17.71

Polycarbonate Coloured Face Screen Shade 3



Part No.	Description	Qty	Price
788948	Full Face Screen	1	£17.59
788946	Spare Shade 3 Visor	1	£14.01

Spare Browguard for Visors



- Lightweight design
- Ratchet adjustment headgear
- 7-position harness strap to allow adjustment to any head size
- 3-position crown angle adjustment

£8.05

Part No. 788940

Welding Helmet with Air Purifying Respirator Auto Darkening



- PAPR (Powered Air-Purifying System) with Auto Darkening Welding Helmet
- Highly efficient filter captures hazardous dust, mists and fumes
- Lithium battery powered blower unit gives the user a cooling stream of air to their head and face for up to eight hours
- Features a loud audible and visual alarm to alert user of low battery/low air
- The welding helmet has adjustable shade control from 9-13
- Fully automatic switching from light to dark on striking arc
- Additional shades 5-8 for gas welding/cutting
- Solar panel power supply

£599.95

Part No. PWH615

Face Protection Shield Top c/w Visor



Part No.	Description	Qty	Price
B185976	Face Protection Shield	1	£18.16
B185977	Replacement Visor	1	£9.20

Welding Helmet Auto Darkening Shade 9-13



£40.01

Part No. S01001

400A Earth Clamp



£7.15

Part No. 564266

Eye Wash & Wound Station with 10 x 20ml Pods & Bracket

- For cleansing wounds to reduce risk of infection
- Slimline neck twist off tops are ready to use in seconds and provide improved directional accuracy
- 20ml saline pods treat both eyes and wounds
- Fixes to the wall for easy access
- It also comes with its own shatterproof mirror and simple instructions for treating minor eye injuries



Part No.	Description	Qty	Price
EA158	Eye Wash Station	1	£19.78
EA160	Eye Wash Refills	1	£7.32

Eye Wash Station

- Highly visible eye and wound wash wall plate, for instant minor eye injuries
- Holds two 500ml eye and wound wash bottles
- It also comes with its own shatterproof mirror and simple instructions for treating minor eye injuries
- The twist off top makes it ready for use in seconds



Part No.	Description	Qty	Price
EA150	Eye Wash Station Deluxe	1	£18.21
EA149	Refill (2x 500ml Eye Solution & 2x Wound Dressings)	1	£7.73
EA152	500ml Eye Irrigation Solution	1	£3.43

300ml Crack Detection Cleaner

- Can be used to clean and prepare surfaces for welding
- Removes dirt, oils and greases
- Can also be used to remove remnants of other Weld Crack detection products such as Developer and Penetrant



£5.26

Part No. 789240

300ml Crack Detection Penetrant

- Used to indicate surface imperfections and cracks
- Use before using crack detection developer



£5.30

Part No. 789242

300ml Crack Detection Developer

- Used to indicate surface imperfections and cracks
- Use Weld Crack Detection Developer after using Weld Crack Detection Cleaner and Penetrant



£5.26

Part No. 789244

300ml Anti-Spatter Spray

- Anti spatter release agent which gives exceptional results with no harmful solvents, silicones or mineral oils
- Odourless, non-flammable & safe in use
- Allows post welding operations, painting, plating, galvanising etc to be undertaken without interference



£3.98

Part No. 564320

500g Tip Dip Anti-Spatter Paste

- Anti-spatter paste helps to protect MIG/TIG welding torches, jigs and fixtures against weld spatter



£8.83

Part No. 564325

White School Chalk - 144pc



£7.81

Part No. 564303

125 x 12 x 5mm French Chalk - 144pc



£15.06

Part No. 564300

2.4mm Flux Impregnated Brazing Rods 2.5kg



£175.97

Part No. 564218

MIG Welding Wire Reels



Part No.	Description	Qty	Price
564273	0.6mm 5kg Reel	1	£32.89
564278	0.8mm 5kg Reel	1	£24.83
564249	0.8mm 15kg Reel	1	£54.36
564251	1.0mm 15kg Reel	1	£48.64

A-NM Short Nozzles



Part No.	Description	Qty	Price
788900	1/32" (3-6mm plate)	1	£4.36
788906	5/64" (70-100mm plate)	1	£4.36
788908	3/32" (90-150mm plate)	1	£4.36
788910	1/8" (140-300mm plate)	1	£4.36

A-NM Long Nozzles



Part No.	Description	Qty	Price
788912	1/32" (3-6mm plate) L	1	£5.48
788914	3/64" (5-12mm plate) L	1	£5.48
788916	1/16" (10-75mm plate) L	1	£5.48
788918	3/32" (90-150mm plate) L	1	£5.48
788920	1/8" (140-300mm plate) L	1	£5.48

Lightweight Nozzles



Part No.	Description	Qty	Price
788922	No. 1 (up to 1.0mm)	1	£3.22
788924	No. 2 (1.0 - 1.5mm)	1	£3.22
788926	No. 3 (1.5 - 2.0mm)	1	£3.22
788928	No. 5 (2.0 - 2.5mm)	1	£3.22
788930	No. 7 (2.5 - 3.0mm)	1	£3.22
788932	No. 10 (3.0 - 4.0mm)	1	£3.22
788934	No. 13 (4.0 - 5.0mm)	1	£3.22
788936	No. 18 (5.0 - 6.0mm)	1	£3.22

Conical Nozzle TB15 Pack of 3



£24.95

Part No. MIG955

Contact Tip Singles

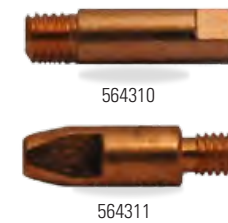

Part No.	Description	Qty	Price
564310	0.8mm TB15 /MB15	1	£0.72
564311	1.0mm MB25	1	£1.30

Flashback Arrestors



Part No.	Description	Qty	Price
788888	Oxygen	1	£25.52
788890	Acetylene/Propane	1	£25.52

2-Gauge Single Stage Regulators



Part No.	Description	Qty	Price
788882	Acetylene Regulator	1	£47.26
788880	Oxygen Regulator	1	£47.26

Spark Ignition Gun



£4.85

Part No. 564243

D/H Lightweight Welding & Cutting Set



Contents:

- D/H Shank
- D/H Cutting Attachment
- D/H Mixer
- No.1 Lightweight Swaged Nozzle
- No.2 Lightweight Swaged Nozzle
- No.3 Lightweight Swaged Nozzle
- No.5 Lightweight Swaged Nozzle
- No.7 Lightweight Swaged Nozzle
- No.10 Lightweight Swaged Nozzle
- No.13 Lightweight Swaged Nozzle
- Nozzle Cleaners (red lid)
- A-FN 1/32" Nozzle
- A-FN 3/64" Nozzle
- DF Combination Spanner

£137.50

Part No. 788801

18" 90° Oxygen/Acetylene Cutting Torch



- 18" 90deg - NM250 style oxygen/fuel gas cutting torch used with NM type nozzles
- The 18" (475mm) handle and 90deg cutting head is the most common size and configuration of oxygen/fuel gas cutting torches
- The oxygen and fuel gases mix in the nozzle to cut steels up to 12in - 300mm thick
- 3/8" BSP gas connections

£52.82

Part No. 789140

Portable Welding & Cutting Set (Boxed)



Contents:

- 1/32" & 3/64" A-FN Nozzles
- S/S Oxygen Regulator - 2g
- Cup Spark Lighter
- Nozzle Cleaners (red lid)
- Oxygen Flashback Arrestor
- Fuel Gas Flashback Arrestor
- D/H Cutting Attachment
- No. 2, 3, 5, 7 Lightweight Nozzle
- S/S Acetylene Regulator - 2g
- Panorama Coloured Goggles Indirect Shade 5
- 1/4" x 5m Oxygen Fitted Hose - 6mm & 1/4" x 5m Acetylene Fitted Hose - 6mm
- DF Combination Spanner
- D/H Mixer
- D/H Shank

£405.90

Part No. 788802

3/8 BSP H/D Welding Hoses 10mm x 10m



Part No.	Description	Qty	Price
788896	Acetylene Hose	1	£30.09
789002	Oxygen Hose	1	£30.09

Superpro Gas Burner / Solder Gun



- Suitable for heating, soldering and shrinking
- Several solder pins available for various applications
- Refillable with lighter fuel
- Features a piezoelectric ignition
- Adjustable flame temperature
- Comes with hot soldering blow SP9 but without gas
- Fitted with retractable stand

£52.88

Part No. B102462

Blue Fire Blow Torch & Gas

Part No.	Description	Qty	Price
111454	Blue Fire Blow Torch & Gas	1	£13.65
B413516	Blue Fire Blow Torch	1	£10.56
B414186	200ml Gas Refill	1	£4.09



Gaz Blow Torch With Gas



£49.05

Part No. 9-3562

350g Butane/Propane Mixed Gas Cartridge



£9.57

Part No. 789152

50g Templers Telux Soldering Flux



£8.88

Part No. 556228

1.5mm Silver Solder Rods Non-Fluxed



- Can be used to join all the common engineering materials (excluding aluminium)

£115.95

Part No. 565020

250g Tinmans Solder Stick



£16.86

Part No. 556214

Multicorded Solder Reels



Part No.	Description	Qty	Price
556212	1.6mm 16SWG	1	£18.84
556210	3.2mm 10SWG	1	£18.94

Lead Free Solder Reel SN99 250g



Part No.	Description	Qty	Price
B011072	0.75mm	1	£25.68
B011073	1mm	1	£20.15

1.5mm x 100g Solder Reel With Resin Core Din EN29454



£5.12

Part No. B936155

18pc AdBlue Straight & Angled Quick Connectors



- Set of 6 different sized straight and 90° AdBlue® fuel line quick connectors allowing for tight connections on fuel line inner diameters of 6mm
- 90° angled connectors sizes: 9.49mm x 6mm, 7.89mm x 6mm & 6.3mm x 6mm - the 90° (elbow) angle provides easier fixing in tight spaces
- Straight connectors sizes: 9.49 x 6mm, 7.89 x 6mm & 6.3 x 6mm
- The self locking connector enables it to be connected & disconnected with ease and speed, with the wide operating temperature range ensures it can cope with the extreme temperatures that could lead to cracking and leaks

£66.34

Part No. BT034226

15pc 90° AdBlue Angled Quick Connectors



- Set of 5 different sized angled AdBlue® fuel line quick connectors allowing for tight connections on fuel line inner diameters of 6mm & 8mm
- Sizes: 9.49 x 6mm, 7.89 x 6mm, 6.3 x 6mm, 9.49 x 8mm, 7.89 x 8mm
- The 90° (elbow) angle provides easier fixing in tight spaces
- The self locking connector enables it to be connected & disconnected with ease and speed, with the wide operating temperature range ensures it can cope with the extreme temperatures that could lead to cracking and leaks

£59.24

Part No. BT034228

Scarab Quick Connector Disconnect Tool

- Quick connector pliers allow one handed operation in tight spaces
- Designed for 2 button style quick connectors used on automotive fuel, oil and coolant systems
- Soft grip handle with finger operated levers
- Length: 120mm; Jaw width: 35mm

£23.33

Part No. BT007826

15pc AdBlue Straight Quick Connectors



- Set of 5 different sized straight AdBlue® fuel line quick connectors allowing for tight connections on fuel line inner diameters of 6mm & 8mm
- Sizes: 9.49 x 6mm, 7.89 x 6mm, 6.3 x 6mm, 9.49 x 8mm, 7.89 x 8mm
- The self locking connector enables it to be connected & disconnected with ease and speed, with the wide operating temperature range ensures it can cope with the extreme temperatures that could lead to cracking and leaks

£56.49

Part No. BT034227

16pc 45° Angled Fuel Line Quick Connectors



- Set of 6 different sized angled fuel line quick connectors allowing for tight connections on a range of fuel line inner diameters from 6mm to 14mm
- Sizes: 7.89 x 6mm, 7.89 x 8mm, 9.89 x 6mm, 9.89 x 8mm, 11.8 x 10mm, 15.82 x 14mm
- The 45° angle provides easier fixing in tight spaces
- The self locking connector enables it to be connected & disconnected with ease and speed, with the wide operating temperature range ensures it can cope with the extreme temperatures that could lead to cracking and leaks

£75.52

Part No. BT034229



AIR LINE FITTINGS

AIR LINE FITTINGS

PCL Airflow Couplings Male Airflow Couplings



Part No.	Description	Qty	Price
570010	1/4 BSP	1	£8.34
520221	3/8 BSP	1	£9.12
570014	1/2 BSP	1	£9.12

Female Airflow Couplings



Part No.	Description	Qty	Price
520219	1/4 BSP	1	£8.34
520233	3/8 BSP	1	£9.31
570012	1/2 BSP	1	£9.12

Airflow Coupling Hose Tailpieces



Part No.	Description	Qty	Price
570016	For 7mm (1/4") Hose	1	£9.12
570018	For 8mm (5/16") Hose	1	£9.12
570020	For 10mm (3/8") Hose	1	£9.12

Airflow Twin Coupling



Part No.	Description	Qty	Price
520238	Airflow Twin Coupling	1	£26.59

PCL Vertex Couplings Male Vertex Couplings



Part No.	Description	Qty	Price
520278	1/4 BSP	1	£15.14
570034	3/8 BSP	1	£15.11
570038	1/2 BSP	1	£15.11

Female Vertex Couplings



Part No.	Description	Qty	Price
570279	1/4 BSP	1	£11.63
570032	3/8 BSP	1	£10.77
570036	1/2 BSP	1	£10.77

Vertex Coupling Hose Tailpieces



Part No.	Description	Qty	Price
570040	For 7mm (1/4") Hose	1	£15.11
570042	For 8mm (5/16") Hose	1	£15.11
570044	For 10mm (3/8") Hose	1	£15.11

Vertex Twin Coupling



Part No.	Description	Qty	Price
570024	Vertex Twin Coupling	1	£26.59

PCL 60 Series Couplings Male 60 Series Couplings



Part No.	Description	Qty	Price
570285	1/4 BSP	1	£23.90
520246	3/8 BSP	1	£23.90
520260	1/2 BSP	1	£23.90

Female 60 Series Couplings



Part No.	Description	Qty	Price
570022	1/4 BSP	1	£23.90
520242	3/8 BSP	1	£23.90
520261	1/2 BSP	1	£23.90

60 Series Adaptor Hose Tailpieces



Part No.	Description	Qty	Price
520231	For 7.9mm (5/16")	1	£5.97
520258	For 9.5mm (3/8")	1	£6.11
520259	For 12.7mm (1/2")	1	£5.97

Male 60 Series Adaptors



Part No.	Description	Qty	Price
570287	1/4 BSP	1	£6.11
520250	3/8 BSP	1	£5.97

Female 60 Series Adaptors



Part No.	Description	Qty	Price
570048	1/4 BSP	1	£5.97
520254	3/8 BSP	1	£5.97

PCL 100 Series Couplings Male 100 Series Couplings



Part No.	Description	Qty	Price
520265	3/8 BSP	1	£29.05
520266	1/2 BSP	1	£29.66

Female 100 Series Couplings



Part No.	Description	Qty	Price
520263	3/8 BSP	1	£30.19
520262	1/2 BSP	1	£30.19

100 Series Adaptor Hose Tailpieces



Part No.	Description	Qty	Price
520274	12.7mm (1/2") Hose	1	£5.34
520276	9.5mm (3/8") Hose	1	£5.22

Male 100 Series Adaptors



Part No.	Description	Qty	Price
570321	3/8 BSP	3	£19.59
520270	1/2 BSP	1	£5.73

Female 100 Series Adaptor



Part No.	Description	Qty	Price
520271	3/8 BSP	1	£7.50

PF Range Male PF Couplings



Part No.	Description	Qty	Price
570150	1/4 BSP	1	£13.79
570152	3/8 BSP	1	£13.79
570329	1/2 BSP	1	£13.79

Female PF Couplings



Part No.	Description	Qty	Price
520286	1/4 BSP	1	£14.08
570146	3/8 BSP	1	£13.79
570336	1/2 BSP	1	£13.79

PF Adaptor/Tailpieces



Part No.	Description	Qty	Price
520290	For 6mm Hose	1	£4.17
570164	For 8mm Hose	1	£4.05
520292	For 10mm Hose	1	£4.05

Male PF Adaptors



Part No.	Description	Qty	Price
520294	1/4 BSP	1	£4.05
570160	3/8 BSP	1	£4.05

Female PF Adaptors



Part No.	Description	Qty	Price
570356	1/4 BSP	1	£4.05
570162	3/8 BSP	1	£4.05

InstantAir Range Male InstantAir Couplings



Part No.	Description	Qty	Price
620214	1/4 BSP	1	£12.12
570148	3/8 BSP	1	£11.88
570166	1/2 BSP	1	£12.38

Female InstantAir Couplings



Part No.	Description	Qty	Price
570168	1/4 BSP	1	£11.88
570170	3/8 BSP	1	£11.88
570172	1/2 BSP	1	£12.38

Adaptor Hose Tailpieces



Part No.	Description	Qty	Price
570184	For 6.35mm (1/4")	1	£8.06
570186	For 7.9mm (5/16")	1	£8.06
570188	For 9.5mm (3/8")	1	£8.23

Male InstantAir Adaptors



Part No.	Description	Qty	Price
620212	1/4 BSP	1	£8.23
570180	3/8 BSP	1	£8.06

Female InstantAir Adaptors



Part No.	Description	Qty	Price
570142	1/4 BSP	1	£8.06
570182	3/8 BSP	1	£8.06

AIR LINE FITTINGS

AIR LINE FITTINGS

Air Line Fittings

Double Union Nuts

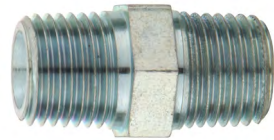

Part No.	Description	Qty	Price
570104	1/4 BSP	1	£3.78
570102	3/8 BSP	1	£4.75
570114	1/2 BSP	1	£6.52

Female Parallel Sockets



Part No.	Description	Qty	Price
570106	1/4 BSP	1	£2.51
570092	3/8 BSP	1	£7.77
570090	1/2 BSP	1	£10.83

Reducing Bushes



Part No.	Description	Qty	Price
570108	3/8-1/4 BSP	1	£1.73
570110	1/2-1/4 BSP	1	£2.82
570112	1/2-3/8 BSP	1	£2.82

Reducing Unions



Part No.	Description	Qty	Price
570116	3/8 BSP Male - 1/4 BSP Male	1	£2.18
570118	1/2 BSP Male - 1/4 BSP Male	1	£3.36
570120	1/2 BSP Male - 3/8 BSP Male	1	£3.36

Safeflow Couplings

Male Safeflow Couplings



Part No.	Description	Qty	Price
9-89110	1/4 BSP	1	£12.52
570136	3/8 BSP	1	£16.19
570140	1/2 BSP	1	£16.19

Female Safeflow Couplings

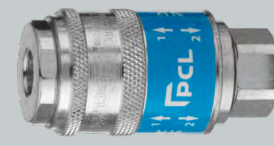

Part No.	Description	Qty	Price
9-89114	1/4 BSP	1	£12.50
570134	3/8 BSP	1	£16.19
570138	1/2 BSP	1	£16.19

XF Range

Male XF Couplings



Part No.	Description	Qty	Price
520235	1/4 BSP	1	£12.02
570028	3/8 BSP	1	£12.02
570200	1/2 BSP	1	£12.02

Female XF Couplings



Part No.	Description	Qty	Price
570026	1/4 BSP	1	£12.02
571100	3/8 BSP	1	£12.02
570030	1/2 BSP	1	£12.02

Male XF Adaptors



Part No.	Description	Qty	Price
9-86848	1/4 BSP	1	£2.54
570000	3/8 BSP	1	£3.14
571104	1/2 BSP	1	£5.41

Female XF Adaptors

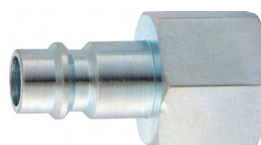

Part No.	Description	Qty	Price
571106	1/8 BSP	1	£2.54
570002	1/4 BSP	1	£2.54
570004	3/8 BSP	1	£3.14
571108	1/2 BSP	1	£5.41

XF Coupling Hose Tailpieces



Part No.	Description	Qty	Price
570006	For 6mm Hose	1	£12.02
570008	For 8mm Hose	1	£12.02
571102	For 9mm Hose	1	£12.02
520227	For 10mm Hose	1	£12.98
520228	For 13mm Hose	1	£12.02

XF Adaptor/Tailpieces



Part No.	Description	Qty	Price
573006	For 6mm Hose	1	£2.78
571110	For 8mm Hose	1	£2.78
571112	For 9mm Hose	1	£2.78
573008	For 10mm Hose	1	£2.78
570301	For 13mm Hose	5	£11.83

Male Standard Adaptors



Part No.	Description	Qty	Price
520226	1/4 BSP	5	£6.07
570056	3/8 BSP	1	£2.65
570054	1/2 BSP	1	£3.41

Female Standard Adaptors



Part No.	Description	Qty	Price
570289	1/4 BSP	1	£1.66
570050	3/8 BSP	1	£2.68
570052	1/2 BSP	1	£3.27

Standard Adaptor Hose Tailpieces



Part No.	Description	Qty	Price
570046	For 4.75mm (3/16")	1	£1.78
520230	For 6.35mm (1/4")	5	£6.29
520232	For 7.9mm (5/16")	5	£6.29
520234	For 9.5mm (3/8")	5	£6.29
570058	For 13mm (1/2")	1	£2.94

1/4 BSPT In-Line Water Trap



£22.84
Part No. 570284

- Designed to help remove moisture from the airline & protect airtools which helps increase the lifespan of the airtools

Hose Tailpiece Adaptors



Part No.	Description	Hose Internal Diameter	Qty	Price
570082	1/4 BSP	4.75mm (3/16")	1	£2.33
520300	1/4 BSP	6.35mm (1/4")	1	£2.33
520302	1/4 BSP	7.9mm (5/16")	1	£2.40
520304	1/4 BSP	9.5mm (3/8")	1	£2.33
520310	1/4 BSP	12.7mm (1/2")	1	£2.40
520306	3/8 BSP	9.5mm (3/8")	1	£2.72
570094	3/8 BSP	12.7mm (1/2")	1	£2.72
570122	3/8 BSP	6.35mm (1/4")	1	£2.72
570124	3/8 BSP	7.9mm (5/16")	1	£2.72
570128	1/2 BSP	9.5mm (3/8")	1	£3.93
520308	1/2 BSP	12.7mm (1/2")	1	£3.93

Air Tool Whip Hoses

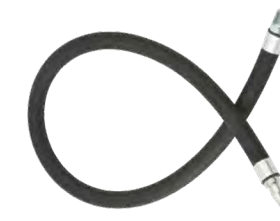

Part No.	Description	Qty	Price
520198	100 Series 1/2 BSP Male x 1/2" ID	1	£17.00
570070	Std Adaptor 1/4BSP Male x 1/4" ID	1	£8.22
570078	Std Adaptor 1/4 BSP Male x 3/8" ID	1	£10.42
570080	Std Adaptor 3/8 BSP Male x 5/16" ID	1	£10.42
570072	Std Adaptor 3/8 BSP Male x 3/8" ID	1	£10.42
570074	XF Adaptor 1/4 BSP Male x 1/4" ID	1	£8.22
570076	XF Adaptor 1/4 BSP Male x 3/8" ID	1	£13.01

1/4 BSP Mini In-Line Air Tool Oiler



£22.87
Part No. 570283

- Automatically lubricates air tools
- Stops tool burn out
- Stops rust and increases torque

Air Hoses

7.5m 10mm OD Polyurethane PU Coiled Air Hose



£28.64

Part No. 520214

Rubber Airline Hose 30m



Part No.	Description	Qty	Price
142018	3/8"	1	£61.94
142022	1/2"	1	£87.69

Airline Hoses with 1/4" BSP Fittings



Part No.	Length	Qty	Price
520201	5/16" - 10m	1	£32.34
520202	5/16" - 20m	1	£78.09
520204	3/8" - 10m	1	£39.45

1/4" BSP Rubber Airline Hose 15m (Female Fittings)



£48.41

Part No. 520209

3/8" Airline Hose 20m with 1/4" BSP Fittings



£66.90

Part No. 520206

1/4 BSP Parallel Probe

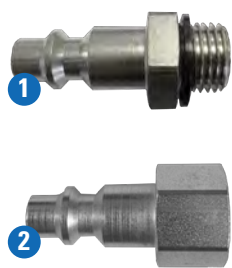

- Prevents risk of whiplash
- Quick-acting vent allowing disconnection to be carried out in total safety
- Rotating sleeve to avoid risk of accidental disconnection
- Low connection/disconnection force even under pressure

Part No.	Description	Qty	Price
1	580224 Male	1	£5.06
2	580227 Female	1	£5.13

1/4 BSP Female Airline Adaptors



- Includes:
- 1/4 BSP Female vertex coupling
 - 1/4 BSP Male screwed adaptor
 - 1/4 BSP x 6.35mm Tailpiece

£9.42

Part No. 520218

10mm OD Coupling And Hosetail



- Prevents risk of whiplash
- Low connection/disconnection force even under pressure
- Polymer sleeve protects equipment from scratching

£18.71

Part No. 580121

10mm ID Probe with Hosetail



- Quick-acting vent allowing disconnection to be carried out in total safety

£3.37

Part No. 580234

1/4 BSP Tapered Thread Male Probe Adaptor



- Quick Release Adapter

£2.08

Part No. 134221

10mm IDx15m Black & Yellow Airline+ C9000/ Probe



£88.46

Part No. 580332

1L Air Tool Oil

- Excellent corrosion and wear protection
- Extends the life of pneumatic tools
- Ideal viscosity
- Good flow and spraying properties
- Protects against corrosion
- Free from silicone



£7.21

Part No. B409814

PCL Retractable Air Hose Reels



- Easy to use adjustable hose stopper - Reduces non-value added time
- Auto retract - Easily and smoothly rewinds the hose
- Built-in cleaning brush as standard to keep the hose clean
- Copper tail outlet thread with dust cap
- Steel wall mounting 180° swivel bracket
- Supplied with fitted leader hose

Part No.	Description	Qty	Price
142102	Bench Top Air Hose Reel, 8m 8bar 8mm i/d Hose	1	£81.97
142100	Bench Top Air Hose Reel, 10m 8bar 6mm i/d Hose	1	£87.46
142108	Workshop Pro AirHose Reel, 15m 17bar 10mm i/d Hose	1	£141.00
142112	Workshop Pro Air Hose Reel, 15m 17bar 12mm i/d Hose	1	£162.90
142114	Workshop Pro Air Hose Reel, 18m 17bar 12mm i/d Hose	1	£198.99
142110	Workshop Pro Air Hose Reel, 20m 17bar 10mm i/d Hose	1	£221.92

PCL Air Connectors

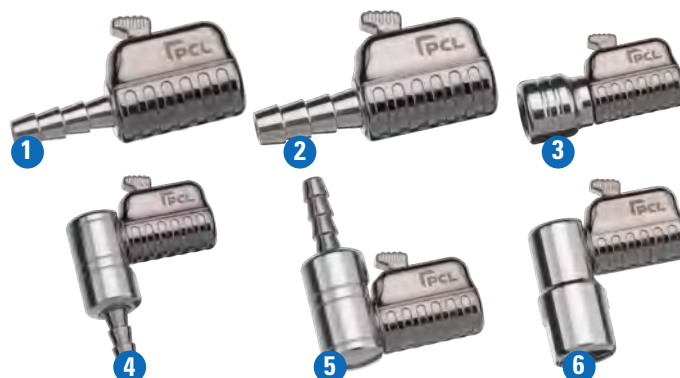

Part No.	Description	Thread Type	Qty	Price	
1	530532	Straight	For 6.35mm/ 1/4" bore hose	1	£15.06
2	530531	Straight	For 7.9mm / 5/16" bore hose	1	£15.06
3	530533	Straight	Rp 1/4 Inlet	1	£15.06
4	530534	Angled	For 7.9mm / 5/16" bore hose	1	£15.06
5	530535	Angled	For 6.35mm/ 1/4" bore hose	1	£15.06
6	530536	Angled	Rp 1/4 Inlet	1	£15.06

Impact Wrenches



Vibration level: > 10.1 m/s²

Vibration level: > 3.4 m/s²

Vibration level: > 3.4 m/s²

Vibration level: > 7.6 m/s²

Vibration level: > 2.5 m/s²

Vibration level: > 3.4 m/s²

Vibration level: > 3.6 m/s²

Vibration level: > 2.8 m/s²

Part No.	Description	Qty	Price
1	B217686 1" Dr Pneumatic Impact Wrench	1	£628.19
2	B183831 1/2 Dr Premium HD Impact Wrench	1	£126.50
3	B183830 1/2 Dr Pneumatic Premium HP Impact Wrench	1	£137.50
4	B217683 3/4 Dr Pneumatic Impact Wrench	1	£389.10

Part No.	Description	Qty	Price
5	B109416 1/2 Dr Standard Impact Wrench	1	£143.47
6	B183793 1/2 Dr Pneumatic Composite Impact Wrench	1	£132.25
7	B044730 3/8 Dr Premium Compact Impact Wrench	1	£250.32
8	BT007680 3/4 Dr Twin Hammer Impact Wrench	1	£275.00

1/2" Drive Ratchet Wrench



£125.09

Part No. B131526

1/4" Drive Ratchet Wrench



£97.90

Part No. B131527

3/8" Drive Ratchet Wrench



£103.77

Part No. B131528

1" Anvil Impact Wrenches



Vibration level: 10.1 m/s² >
Weight: 6.5kg

Part No.	Description	Qty	Price
1	B217685 1" Short Anvil Air Impact Wrench	1	£522.94
2	B217687 1" Long Anvil Air Impact Wrench	1	£617.57

Die Grinders



Part No.	Description	Qty	Price
1	B201146 90° Air Angle Die Grinder	1	£67.39
2	B201144 Air Short Die Grinder	1	£52.18
3	B201145 Air Long Die Grinder	1	£99.12

WHIP HOSES SEE PAGE 147

Reciprocating Saw

- Easy to use
- Adjustable speed
- Metal housing with insulated rubber grip
- Vibration Level: 27.2 m/s²



£78.17

Part No. B010664

115/125mm Angle Grinder

- Disc Ø 115 and 125mm discs
- Also suitable for 1mm discs
- Fatigue-free working due to handy, compact design
- Long tool life due to robust high-performance motor
- Vibration Level: 2.5 m/s²



£178.54

Part No. B010813

10mm Drill



- Compact and lightweight design: ideal for working in small spaces
- Keyless chuck
- Left/right turning
- Metal housing
- Vibration Level: 2.5 m/s²

£71.07

Part No. B010467

Adhesive Removal Tool



- For removing stickers, glue residues, foil etc. on bodywork, paint and glass
- Vibration Level: 2.5 m/s²

Part No.	Description	Qty	Price
B201147	Removal Tool	1	£77.96
B201148	Caramel Wheel	1	£7.88

Blow Gun



- For blowing-out and drying parts
- Lightweight
- Insulated ergonomic handle
- Adjustable air volume
- Venturi nozzle ensures more air volume & low air consumption

£9.20

Part No. B333604

Loop Ratchets



Part No.	Description	Qty	Price
B129073	Pneumatic Loop Ratchet	1	£114.84
B130708	Pneumatic Loop Ratchet Set	1	£233.99

10mm Air Belt Sander with 40 Abrasive Belts

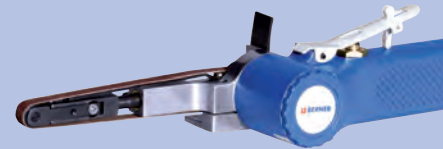

GREAT DEAL

Air Belt Sander

- Optimal for working on bodywork, for deburring or de-rusting of metal pieces
- Ideal for work in hard to reach places
- Small, handy & powerful belt sander
- Belts can be changed easily & quickly with one hand due to quick-release system
- Vibration: 2.5 m/s²

330mm Abrasive Belts

- 10 each of 40G, 60G, 80G & 120G

Part No.	Description	Qty	Price
B510341	Air Belt Sander & 40 Belts	1	£124.74
B099918	Air Belt Sander	1	£122.43

1/2 Dr Premium HP Impact Wrench & Impact Sockets



GREAT DEAL

Impact Wrench

- Twin hammer mechanism
- One hand control
- High power output
- Maximum loosening torque: 1600 N/m
- Maximum tightening torque: 800 N/m
- Vibration Level: 3.4 m/s²

Impact Sockets

- 1 x 13, 15, 17, 18, 19, 21, 22, 24, 27, 30 and 32mm

£225.72

Part No. B000183

Multi Function Pneumatic Brush Grinding Kit



£366.80

Part No. B214991

- For cleaning threads, welds, fittings, sheet metal etc
- Different brushes suitable for removing (underbody) coatings, paints, sealants, gaskets, seals, rust etc
- Caramel disc is suitable for use on stickers, adhesive residues, vinyl and foil etc on smooth surfaces e.g. bodywork, lacquer and glass

Part No.	Description	Qty	Price
1	B038662 23mm Caramel Wheel	1	£14.52
2	B038667 23mm Coarse Brush	1	£19.06
3	B038666 23mm Medium Brush	1	£13.70
4	B038828 23mm Fine Brush	1	£13.57

WOODline Jigsaw Blades



Part No.	Description	Qty	Price
B372364-5	1.3/50mm C	5	£16.27
B372354-5	2.5/75mm	5	£6.42
B372355-5	2.5/75mm R 5T	5	£17.33

94mm Air Hacksaw Blades

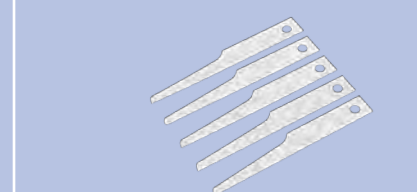

Part No.	Description	Qty	Price
538342	24TPI	5	£11.95
538340	14TPI	5	£11.95

Jigsaw Blades



Part No.	Description	Qty	Price
1	719206 92mm For PVC & Wood	5	£6.90
2	719208 100mm For Aluminium	5	£12.96

METALline Jigsaw Blades



Part No.	Description	Qty	Price
B372371-5	3.0/75mm	5	£4.46
B372674-5	2.0/50mm	5	£15.48
B372368-5	1.2/50mm	5	£6.80

Jigsaw Blades For Metal

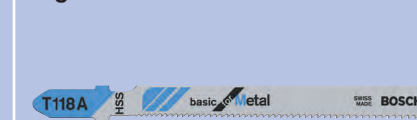

Part No.	Description	Qty	Price
903136	3" 36TPI	5	£11.81
904183	92mm 14TPI	5	£16.45

3" 10TPI Jigsaw Blades for PVC and Wood T101B



£11.58

Part No. 904184



18V Brushless Drill Driver



- More power with a heavy load
- 2-stage, brushless motor with torque of 135Nm
- Only 175mm long and only weighs 2.1kg
- All-metal keyless chuck
- B369783: supplied with 2x 5.0Ah Li-ion batteries and charger

Part No.	Description	Price
B369783	Set	£465.55
B369784	Bare Tool	£220.53

18V 1/2 Chuck Drill Driver



- Compact, only 185mm in length
- 4-pole motor delivers maximum power
- 13mm metal drill chuck
- 17-adjustable torque positions
- B241989: supplied with 2x 5.0Ah Li-ion batteries and charger

Part No.	Description	Price
B241989	Set	£446.94
B241991	Bare Tool	£161.65

18V 1/2 Dr Brushless Impact Gun



- Lightweight & compact
- Brushless motor
- The drive control allows the machine to be used in 4 different torque settings
- B245804: supplied with 2x 5.0Ah Li-ion batteries and charger

Part No.	Description	Price
B412905	Set	£523.09
B412906	Bare Tool	£225.52

18V 1/2 Dr Impact Wrench



- For heavy duty applications: steel manufacturing, industrial construction & car workshops
- Lightweight & ergonomic
- 4-pole motor delivers a torque of 610Nm
- B242004: supplied with 2x 5.0Ah Li-ion batteries and charger

Part No.	Description	Price
B242004	Set	£448.92
B175173	Bare Tool	£203.83

18V 125mm Brushless Angle Grinder

- Up to 10x longer motor life due to brushless motor
- Narrow handle with paddle switch
- Removable dust caps extend the life of the machine
- B250801: supplied with 2x 5.0Ah Li-ion batteries and charger



Part No.	Description	Price
B412909	Set	£466.99

Part No.	Description	Price
B412911	Bare Tool	£203.64

18V Jigsaw

- Quick & easy exchange of blades
- Heavy duty 4-pole frameless motor
- Overload protection for unsurpassed durability
- 4-position adjustable pendulum stroke
- B244758: supplied with 2x 5.0Ah Li-ion batteries



Part No.	Description	Price
B244758	Set	£545.97

Part No.	Description	Price
B244759	Bare Tool	£348.78

18V 190mm Circular Saw

- Brushless motor
- Built-in dust blower keeps the cutting line clean
- 190mm blade with 66mm cutting depth
- 50° mitre angle
- B340658: supplied with 2x 5.0Ah Li-ion batteries and charger



Part No.	Description	Price
B340658	Set	£610.57

Part No.	Description	Price
B340659	Bare Tool	£462.89

18V Reciprocating Saw

- 4-pole motor: optimal power/weight ratio
- Powerful & fast: 25mm stroke length / 3200 strokes per minute
- Quick-change system
- B241996: supplied with 2x 5.0Ah Li-ion batteries and charger



Part No.	Description	Price
B241996	Set	£573.75

Part No.	Description	Price
B241997	Bare Tool	£259.70

18V 4 Speed Brushless 1/2 Dr Impact Wrench



- Ideal for heavy duty applications: steel manufacturing, mechanical seals, industrial construction and workshops
- High torque that tightens bolts and nuts with a maximum of 950Nm and delivers a loosening torque of a maximum of 1491Nm
- Four speeds and various coupling settings for maximum versatility
- B366314: supplied with 2x 5.0Ah Li-ion batteries and charger

Part No.	Description	Price
B366314	Set	£689.13
B366313	Bare Tool	£347.81

18V Hammer Drill



- Compact and ergonomic design
- 4-position function: hammer drill, chiselling, drilling without impact and vario-lock
- Carbon brushless motor for up to 2x longer engine life and up to 25% more power
- Powerful hammer mechanism delivers 2.5J of impact force at one low 8.9 m/s vibration emission
- B366314: supplied with 2x 5.0Ah Li-ion batteries and charger

Part No.	Description	Price
B250799	Set	£614.36
B250798	Bare Tool	£397.99

18V 1/4 Dr Impact Screwdriver



- 4-pole motor: optimal power/weight ratio
- Blows per minute: 3200 bpm
- Special stroke mechanism
- B241993: supplied with 2x 5.0Ah Li-ion batteries and charger

Part No.	Description	Price
B241993	Set	£441.33
B241995	Bare Tool	£172.62

18V Straight Grinder Bare Tool



- Long slim design: ideal for hard to reach areas
- 2-speed for optimal use
- Lock-out ensures the machine does not start automatically if the switch remains pressed after power failure
- Full metal gear drive for longer life

£417.25

Part No. B335075

18V Grease Gun Bare Tool



- Adjustable: pump the required amount before use
- Very high pressure: 562 bar
- Can be used for heavy machinery and at very low temperatures
- 1220mm hose: the longest on the market
- LED system: can be used in dark spaces
- Piston with pressure gauge helps to check the remaining grease level

£295.47

Part No. B242000

18V 310ml Caulking Gun



- Maximum performance and protection from overload and overheating due to battery technology
- Remote speed dial and variable speed trigger (6 speed settings) for maximum bead control
- Can be converted to use with 600ml sausages
- B242001: supplied with 1x 2.0Ah Li-ion battery

Part No.	Description	Price
B242001	Set	£389.49
B242603	Bare Tool	£218.90

18V 400ml Caulking



- Maximum performance and protection from overload and overheating due to battery technology
- Remote speed dial and variable speed trigger (6 speed settings) for maximum bead control
- Can be converted to use with 600ml sausages
- Transparent barrel
- B242601: supplied with 1x 2.0Ah Li-ion battery

Part No.	Description	Price
B242601	Set	£504.67
B242602	Bare Tool	£358.23

18V 5.0 Ah Li-ion Battery & Charger



Part No.	Description	Price
B241915	Battery	£127.09
B250795	14.4-18V Charger	£97.85

Supplier of high quality market leading Power Tools



View online at unitedindustrial.co.uk to find the tool to meet your budget and job

STANDARDline (DIN338) Metric Drills



- High Speed Steel Roll Forged drills
- Suitable for drilling in a range of materials such as metal & plastic
- They can be used in hand and power drills

Part No.	Description	Qty	Price
8322-10	1.5mm	10	£3.73
8323-10	2mm	10	£5.40
8324-10	2.5mm	10	£5.53
8325-10	3mm	10	£5.96
8326-10	3.2mm	10	£5.78
560260-10	3.3mm	10	£5.85
8327-10	3.5mm	10	£6.26
8328-10	4mm	10	£6.78
8329-10	4.2mm	10	£6.86
8330-10	4.5mm	10	£7.39
158631-10	4.9mm	10	£7.43
8332-10	5mm	10	£7.15
158640-10	5.1mm	10	£7.85
158658-10	5.4mm	10	£7.85
8333-10	5.5mm	10	£9.63
8334-10	6mm	10	£10.81
8336-10	6.5mm	10	£17.02
158720-10	6.8mm	10	£16.06
8337-10	7mm	10	£16.94
8339-10	7.5mm	10	£18.33
8340-5	8mm	5	£10.47
8341-5	8.5mm	5	£10.23
158771-5	8.8mm	5	£16.50
8342-5	9mm	5	£17.03
8343-5	9.5mm	5	£17.23
8344-5	10mm	5	£17.95
8345	10.5mm	1	£5.01
8347	11mm	1	£5.52
8348	11.5mm	1	£6.12
8349	12mm	1	£6.45
8350	12.5mm	1	£7.73
158950	15mm	1	£19.35
159000	16.5mm	1	£19.48

STANDARDline (DIN338) Imperial Drills



- High Speed Steel Roll Forged drills
- Suitable for drilling in a range of materials such as metal & plastic
- They can be used in hand and power drills

Part No.	Description	Qty	Price
158879-10	1/32	10	£5.83
159115-10	3/64	10	£6.34
158798-10	1/16	10	£7.92
159158-10	5/64	10	£7.93
159107-10	3/32	10	£8.29
159174-10	7/64	10	£8.43
158828-10	1/8	10	£9.12
159190-10	9/64	10	£9.85
159140-10	5/32	10	£12.00
158917-10	11/64	10	£11.03
158836-10	3/16	10	£11.86
158941-10	13/64	10	£11.95
159166-10	7/32	10	£14.51
158976-10	15/64	10	£16.24
158810-10	1/4	10	£17.83
159018-10	17/64	10	£19.26
159182-10	9/32	10	£19.44
159026-10	19/64	10	£19.80
158844-5	5/16	5	£12.83
159042-5	21/64	5	£17.69
158909-5	11/32	5	£19.64
159050-5	23/64	5	£18.24
158615-5	3/8	5	£19.77
159069-5	25/64	5	£26.43
158925	13/32	1	£2.74
159077	27/64	1	£3.13
158852	7/16	1	£5.58
159085	29/64	1	£5.68
158968	15/32	1	£5.78
159131	31/64	1	£6.15
158801	1/2	1	£8.01
158860	9/16	1	£7.69
158712	5/8	1	£9.36

HYPACut (DIN338) Metric Drills



- General-purpose drill, to drill steels with tensile strength up to 1000 N/mm², cast steel, grey cast iron, malleable cast iron, nickel brass and graphite
- The additional split detail permits better positioning and reduced feed force and torque

Part No.	Description	Qty	Price
708122	1.5mm	5	£3.49
708128	2mm	5	£3.58
708134	2.5mm	5	£5.67
708140	3mm	5	£6.19
708146	3.5mm	5	£7.05
708152	4mm	5	£7.08
708158	4.5mm	5	£8.16
708164	5mm	5	£8.20
708170	5.5mm	5	£8.40
708176	6mm	5	£9.17
708182	6.5mm	3	£9.58
708188	7mm	3	£7.76
708194	7.5mm	3	£8.51
708200	8mm	3	£10.18
708206	8.5mm	3	£10.55
708212	9mm	3	£13.10
708218	9.5mm	3	£13.26
708224	10mm	3	£15.37
708230	10.5mm	2	£11.62
708236	11mm	2	£12.29
708242	11.5mm	2	£12.44
708248	12mm	2	£13.64
708254	12.5mm	2	£14.25
708260	13mm	2	£17.25

HYPACut (DIN338) Imperial Drills



- General-purpose drill, to drill steels with tensile strength up to 1000 N/mm², cast steel, grey cast iron, malleable cast iron, nickel brass and graphite
- The additional split detail permits better positioning and reduced feed force and torque

Part No.	Description	Qty	Price
707916	1/16	5	£6.50
707922	5/64	5	£7.28
707928	3/32	5	£10.74
707934	7/64	5	£6.51
707940	1/8	10	£9.14
707946	9/64	5	£8.51
707952	5/32	5	£6.05
707958	11/64	5	£5.47
707964	3/16	10	£13.16
707970	13/64	5	£8.64
707976	7/32	5	£7.00
707982	15/64	5	£9.11
707988	1/4	10	£24.81
707994	17/64	3	£10.73
708000	9/32	3	£9.96
708006	19/64	3	£9.96
708012	5/16	5	£16.57
708018	21/64	3	£13.05
708024	11/32	3	£13.55
708030	23/64	3	£15.43
708036	3/8	5	£24.56
708042	25/64	3	£19.54
708048	13/32	3	£21.87
708054	27/64	2	£16.75
708060	7/16	3	£28.27
708066	29/64	2	£18.14
708072	15/32	2	£19.82
708078	31/64	2	£23.28
708084	1/2	2	£22.47

TiNcoated (DIN338) Metric & Imperial Drills

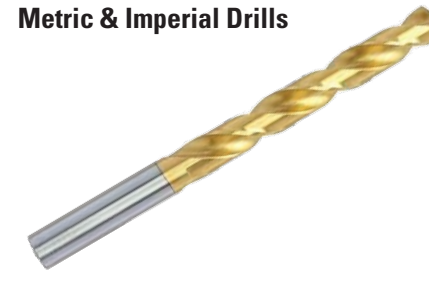

- General-purpose drill, to drill steels with tensile strength up to 1000 N/mm², cast steel, grey cast iron, malleable cast iron, nickel brass and graphite
- The additional split detail permits better positioning and reduced feed force and torque
- TiN coating provides longer tool life or increased cutting speeds

Metric Drills

Part No.	Description	Qty	Price
740000	1mm	10	£12.78
740003	1.5mm	10	£9.61
740005	2mm	10	£9.49
740007	2.5mm	10	£9.49
740009	3mm	10	£9.65
740010	3.1mm	10	£16.14
740011	3.2mm	10	£12.21
740013	3.3mm	10	£11.61
740015	3.5mm	10	£12.18
740018	4mm	10	£13.64
740021	4.2mm	10	£14.18
740026	4.5mm	10	£14.66
740030	4.9mm	10	£16.71
740032	5mm	10	£16.75
740040	5.5mm	10	£21.95
740042	5.7mm	10	£26.64
740044	6mm	10	£28.96
740045	6.1mm	10	£28.50
740048	6.5mm	10	£29.52
740050	6.6mm	10	£29.21
740052	6.8mm	10	£29.41
740054	7mm	10	£30.33
740058	7.5mm	10	£31.21
740064	8mm	10	£35.17
740067	8.5mm	10	£40.08
740073	9mm	10	£46.78
740076	9.5mm	10	£47.07
740080	10mm	10	£54.79
740082	10.2mm	5	£42.21
740086	10.5mm	5	£33.76
740094	11mm	5	£39.90
740098	11.5mm	5	£39.18
740102	12mm	5	£46.84
740110	12.5mm	5	£47.76
740114	13mm	5	£52.54
740122	14mm	1	£23.11

Part No.	Description	Qty	Price
740126	14.5mm	1	£34.96
740130	15mm	1	£25.43
740138	16mm	1	£28.17

Imperial Drills

Part No.	Description	Qty	Price
740403	1/16	10	£9.55
740406	5/64	10	£11.23
740409	3/32	10	£11.64
740412	7/64	10	£11.98
740415	1/8	10	£12.40
740418	9/64	10	£14.06
740421	5/32	10	£14.18
740424	11/64	10	£15.52
740427	3/16	10	£15.52
740430	13/64	10	£20.25
740433	7/32	10	£20.74
740434	15/64	10	£22.75
740436	1/4	10	£24.12
740439	17/64	10	£27.83
740442	9/32	10	£33.07
740445	19/64	10	£37.68
740448	5/16	10	£38.78
740451	21/64	10	£46.40
740454	11/32	10	£39.18
740457	23/64	10	£42.00
740460	3/8	10	£45.22
740463	25/64	5	£34.55
740466	13/32	5	£27.75
740469	27/64	5	£30.10
740472	7/16	5	£31.69
740475	29/64	5	£36.73
740478	15/32	5	£38.49
740481	31/64	5	£46.18
740484	1/2	5	£48.55

Bright Finish Silver (DIN338) HSS SP Drills



- General-purpose drill suitable to drill steels with tensile strength up to 1.000 N/mm², cast steel, grey cast iron, malleable cast iron, nickel brass and graphite
- 130° split detail permits better positioning and reduced feed force and torque

Part No.	Description	Qty	Price
B131233	0.5mm	10	£3.42
B131236	0.8mm	10	£3.67
700610	1mm	10	£4.13
B131239	1.1mm	10	£4.20
B131240	1.2mm	10	£4.20
B131241	1.3mm	10	£4.20
B131243	1.4mm	10	£4.22
700612	1.5mm	10	£4.53
B131245	1.6mm	10	£4.61
B131246	1.7mm	10	£4.61
B131247	1.8mm	10	£4.69
B131248	1.9mm	10	£4.69
700614	2mm	10	£4.93
B131250	2.1mm	10	£6.08
B131251	2.2mm	10	£4.70
B131253	2.4mm	10	£7.30
700616	2.5mm	10	£5.06
B131255	2.6mm	10	£6.48
B131256	2.7mm	10	£5.01
B131257	2.8mm	10	£5.01
B131258	2.9mm	10	£5.01
700618	3mm	10	£5.62
B131260	3.1mm	10	£5.07
700620	3.2mm	10	£6.34
700622	3.3mm	10	£5.83
B131263	3.4mm	10	£5.72
700624	3.5mm	10	£6.34
B131265	3.6mm	10	£5.89
B131266	3.7mm	10	£5.95
B131267	3.8mm	10	£5.95
B131268	3.9mm	10	£5.95
700628	4mm	10	£7.27
B131270	4.1mm	10	£7.54

Part No.	Description	Qty	Price
700630	4.2mm	10	£7.92
B131272	4.3mm	10	£7.54
B131273	4.4mm	10	£8.10
700632	4.5mm	10	£8.32
B131275	4.6mm	10	£7.80
B131276	4.7mm	10	£10.73
700634	4.8mm	10	£9.06
700636	4.9mm	10	£9.17
700638	5mm	10	£9.17
B131280	5.1mm	10	£9.31
B131281	5.2mm	10	£13.70
B131282	5.3mm	10	£11.95
B131283	5.4mm	10	£9.86
700640	5.5mm	10	£12.64
B131285	5.6mm	10	£17.02
B131286	5.7mm	10	£11.74
700642	5.8mm	10	£13.02
B131288	5.9mm	10	£12.12
700646	6mm	10	£14.03
B131290	6.1mm	10	£13.35
B131291	6.2mm	10	£17.33
B131292	6.3mm	10	£17.08
B131293	6.4mm	10	£15.04
700648	6.5mm	10	£16.73
B131295	6.6mm	10	£23.12
B131296	6.7mm	10	£14.93
700650	6.8mm	10	£18.36
700652	7mm	10	£19.20
B131300	7.1mm	10	£18.67
B131301	7.2mm	10	£26.24
B131302	7.3mm	10	£25.41
700654	7.5mm	10	£21.67
B131306	7.7mm	10	£28.97
B131307	7.8mm	10	£20.30
B131308	7.9mm	10	£21.25
700656	8mm	5	£14.23
B131313	8.4mm	5	£14.78
700658	8.5mm	5	£15.90
B131316	8.7mm	5	£17.02
700660	9mm	5	£17.69
B131330	9.4mm	5	£22.69
700662	9.5mm	5	£18.28
700664	10mm	5	£20.98
B131340	10.2mm	1	£5.42
700668	10.5mm	1	£5.72
700670	11mm	1	£5.74

Part No.	Description	Qty	Price
700672	11.5mm	1	£8.03
700674	12mm	1	£8.07
700676	12.5mm	1	£8.06
700680	13mm	1	£8.83

HSS Reduced Shank Twist Drills (DIN338)

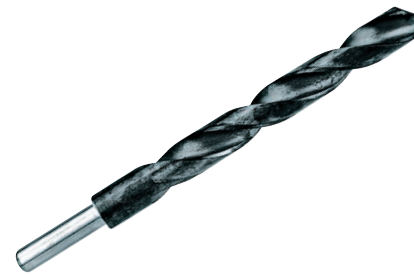

- Suitable for structural steel up to a tensile strength of 1000 N/mm², cast iron, non-ferrous metals, in hand and pillar drills
- Point angle: 118°

Part No.	Description	Qty	Price
B008353	13.5mm	1	£5.87
B8355	14mm	1	£6.13
B008356	14.5mm	1	£7.06
B008357	15mm	1	£9.11
B008358	15.5mm	1	£11.55
B8359	16mm	1	£11.68
B008360	16.5mm	1	£11.88
B8361	17mm	1	£11.96
B008362	17.5mm	1	£12.07
B008363	18mm	1	£12.07
B008364	18.5mm	1	£14.12
B008365	19mm	1	£25.42
B008366	20mm	1	£17.94

HSS Cobalt Drills



Part No.	Description	Qty	Price
726997	5mm	10	£24.76
726996	6.4mm	1	£9.43

PREMIUM^{line} (DIN338) Co5 Cobalt Drills



- Suitable for structural steel up to a tensile strength of 1000 N/mm², cast iron, non-ferrous metals, in hand and pillar drills
- Point angle: 118°

Part No.	Description	Qty	Price
B367242-5	1mm	5	£4.53
B367243-5	1.5mm	5	£4.11
B367244-5	2mm	5	£4.16
B367245-5	2.5mm	5	£4.16
B367246-5	3mm	5	£4.16
B367247-5	3.2mm	5	£4.82
B367248-5	3.3mm	5	£5.13
B367249-5	3.5mm	5	£5.24
B367250-5	4mm	5	£5.52
B367252-5	4.2mm	5	£6.23
B367253-5	4.5mm	5	£6.38
B367254-5	5mm	5	£6.66
B008518-3	5.1mm	3	£4.73
B367256-3	5.2mm	3	£4.87
B367257-3	5.5mm	3	£5.10
B367258-3	6mm	3	£5.60
B367259-3	6.5mm	3	£6.97
B008525-3	6.8mm	3	£7.70
B367261-3	7mm	3	£10.11
B367262-3	7.5mm	3	£10.53
B367263-3	8mm	3	£10.97
B367264-3	8.5mm	3	£11.83
B367265-3	9mm	3	£12.76
B367266-3	9.5mm	3	£14.20
B367267-3	10mm	3	£15.65
B367269	10.5mm	1	£7.02
B367270	11mm	1	£8.05
B367271	11.5mm	1	£9.21
B367272	12mm	1	£9.94
B367273	12.5mm	1	£12.19
B367274	13mm	1	£12.25
B367275	14mm	1	£15.82
B367276	15mm	1	£17.33

EXTREME^{cut} Multifunctional Drills



4-fold volume drill spiral for quick drill dust removal

Hard metal plate with razor-sharp cutting edges

- Extremely versatile and precise drilling - even with drilling in various materials
- Drills accurately without cracking tiles, natural stone, metal, wood and plastic
- Ideal for solid brick, hollow building stone, roof tile, marble, tiles, wood, metal and plastic
- Suitable for concrete, natural stone, ceramic tiles
- Carbide tip - Extra sharp cutting edges, also very suitable for metal

5pc Standard Set



Set Contents		Top Ups	
Description	Qty	Part No.	Qty Price
4 x 75mm	1	B406853	1 £7.51
5 x 85mm	1	B406854	1 £7.60
6 x 100mm	1	B406855	1 £7.80
8 x 120mm	1	B406857	1 £8.39
10 x 120mm	1	B406858	1 £9.10

£36.87

Part No. B406859



4pc Long Set



Set Contents		Top Ups	
Description	Qty	Part No.	Qty Price
6 x 400mm	1	B406867	1 £26.80
8 x 400mm	1	B406868	1 £27.93
10 x 400mm	1	B406878	1 £29.34
12 x 400mm	1	B406879	1 £30.65

£97.94

Part No. B406881

5pc SDS-PLUS Set



Set Contents		Top Ups	
Description	Qty	Part No.	Qty Price
5 x 110mm	1	B406860	1 £10.58
6 x 110mm	1	B406861	1 £11.23
6 x 160mm	1	B406862	1 £10.87
8 x 160mm	1	B406863	1 £13.30
10 x 160mm	1	B406865	1 £13.71

£51.96

Part No. B406866

Bi-Metal HSS Quick Change Holesaws & Adaptors



Part No.	Description	Qty	Price
B371702	14mm	1	£6.13
B371703	16mm	1	£6.13
B371704	19mm	1	£6.68
B371708	20mm	1	£6.44
B371709	21mm	1	£6.44
B371710	22mm	1	£6.73
B371711	25mm	1	£6.17
B371712	27mm	1	£6.84
B371713	29mm	1	£6.30
B371714	32mm	1	£7.92
B371715	35mm	1	£7.92
B371716	38mm	1	£8.55
B371717	40mm	1	£7.44
B371719	43mm	1	£8.94
B371720	44mm	1	£8.94
B271721	51mm	1	£9.53
B371722	54mm	1	£11.31
B371723	57mm	1	£11.94
B371724	60mm	1	£11.35
B371725	64mm	1	£12.34
B371726	65mm	1	£10.76
B371727	67mm	1	£11.69
B371728	68mm	1	£12.64
B371729	76mm	1	£12.64
B371730	83mm	1	£14.22
B371731	92mm	1	£14.97
B371732	102mm	1	£20.00
B371733	127mm	1	£43.69
B371734	8.7 x 70mm Fast Change Hexagonal Holesaw Adaptor	1	£12.00
B371737	11 x 75mm Fast Change Hexagonal Holesaw Adaptor	1	£12.03
B371736	11 x 304mm Fast Change Hexagonal Holesaw Adaptor	1	£19.60
B371735	105mm SDS+ Fast Change Holesaw Adaptor	1	£15.84
B371741	85mm HSS-G Fast Change Centre Drill	1	£5.67
B371742	85mm HSS-CO Fast Change Centre Drill	1	£5.67

Holesaws and Arbors



Holesaws

• Pack quantity: 1

Part No.	Size	Price	Part No.	Size	Price
B167673	14mm	£3.48	B412228	60mm	£8.69
B590029	16mm	£3.34	B345407	64mm	£8.75
B023550	17mm	£3.67	B023567	65mm	£8.86
B345318	19mm	£3.94	B345415	67mm	£8.92
B134647	20mm	£4.03	B374067	68mm	£9.32
B936449	21mm	£4.13	B545090	70mm	£9.63
B345326	22mm	£4.30	B040563	73mm	£9.88
B023554	24mm	£4.40	B345423	76mm	£10.48
B345334	25mm	£4.40	B879258	79mm	£9.42
B023556	27mm	£4.49	B219592	83mm	£11.14
B412678	29mm	£4.65	B416037	86mm	£10.65
B846972	30mm	£4.96	B879282	89mm	£12.00
B345342	32mm	£5.29	B411477	92mm	£12.54
B345350	35mm	£6.01	B545104	95mm	£18.37
B936450	37mm	£6.06	B879290	98mm	£15.03
B345369	38mm	£6.08	B139076	102mm	£15.38
B121975	40mm	£6.13	B351830	105mm	£15.46
B468498	41mm	£6.24	B775541	108mm	£14.68
B001133	43mm	£6.24	B545112	111mm	£15.91
B345377	44mm	£6.24	B670073	114mm	£15.10
B545040	46mm	£6.62	B353477	121mm	£18.80
B545058	48mm	£7.04	B353272	127mm	£20.65
B345385	51mm	£8.31	B119090	140mm	£23.16
B936452	54mm	£8.40	B936457	152mm	£22.31
B345393	57mm	£8.55			

Arbors

Part No.	Description	Qty	Price
B106574	A1 Arbor 14-30mm	1	£7.88
B345431	A2 Arbor 32-152mm	1	£13.83
B468538	A4 Arbor 32mm	1	£10.88
B345458	300mm A2 Arbor Extension	1	£7.54
B355836	Guide Drill for A4 Arbor	1	£5.48

Starrett Holesaws and Arbors



Part No.	Size mm(in)	Qty	Price
800001	16mm (5/8)	1	£8.07
800002	17mm (11/16)	1	£7.90
800003	19mm (3/4)	1	£7.99
800004	20mm (25/32)	1	£8.38
800005	21mm (13/16)	1	£8.06
800006	22mm (7/8)	1	£8.06
800007	24mm (15/16)	1	£8.31
800008	25mm (1)	1	£10.33
800009	29mm (1.1/8)	1	£10.71
800010	30mm (1.3/16)	1	£11.51
800011	32mm (1.1/4)	1	£11.85
800012	33mm (1.5/16)	1	£11.70
800013	35mm (1.3/8)	1	£13.01
800015	38mm (1.1/2)	1	£13.66
800017	41mm (1.5/8)	1	£15.98
800019	44mm (1.3/4)	1	£16.62
800020	46mm (1.13/16)	1	£17.23
800022	51mm (2)	1	£18.56
800023	52mm (2.1/16)	1	£17.76
800024	54mm (2.1/8)	1	£19.24
800025	56mm (2.3/16)	1	£19.24
800026	57mm (2.1/4)	1	£19.32
800028	60mm (2.3/8)	1	£21.90
800029	64mm (2.1/2)	1	£20.67
800030	65mm (2.9/16)	1	£20.67
800033	70mm (2.3/4)	1	£20.70
800035	76mm (3)	1	£22.96
800036	79mm (3.1/8)	1	£21.98
800037	83mm (3.1/4)	1	£22.44
800039	89mm (3.1/2)	1	£24.65
800040	92mm (3.5/8)	1	£28.53
800059	14-30mm A1 Arbor	1	£10.09
800060	32-210mm A2 Arbor	1	£23.10

HSS Long Series Drills



- General-purpose drill, to drill steels with tensile strength up to 1.000 N/mm², cast steel, grey cast iron, malleable cast iron, nickel brass and graphite
- The web thinning permits better positioning and reduced feed force and torque
- Capable of drilling deep holes or through drill bushings

Part No.	Description	Qty	Price
755418	5.5mm	10	£31.66
755421	6mm	5	£22.54
755429	8mm	5	£42.52
755098	10mm	5	£65.77
B367330	12mm	1	£18.12

Pop Rivet Double Ended Drill (DIN1897)



- For structural steel (to tensile strength of 1000N/mm²), cast iron, stainless steel and non-ferrous metals
- Can be used in drill presses, power tools and CNC machines
- Self-centering by split point cutting with 118° point angle

Part No.	Description	Qty	Price
B367332-10	3mm	10	£11.92
B367333-10	3.1mm	10	£12.16
B367334-10	3.2mm	10	£12.64
B367335-10	3.3mm	10	£12.86
B367336-10	3.5mm	10	£13.08
B367337-10	4mm	10	£13.72
B367338-10	4.1mm	10	£13.94
B367339-10	4.2mm	10	£14.16
B367340-10	4.5mm	10	£19.06
B367341-10	4.9mm	10	£18.80
B367342-10	5mm	10	£19.03
B367343-5	5.1mm	5	£8.58
B367344-5	5.2mm	5	£9.06
B367345-5	5.5mm	5	£14.42
B367346-5	6mm	5	£15.04
B367347-5	6.5mm	5	£20.26

HSS Step Drills



Part No.	Description	Qty	Price
B159628	4-30mm	1	£67.65

HSS Self-Centering Step Drills



Part No.	Description	Qty	Price
B122068	1M 4-12mm	1	£8.42
B919748	2M 4-12mm	1	£8.80
B155551	3M 6-18mm	1	£27.29
B631957	4M 4-22mm	1	£32.49
B724343	29M 5-29mm	1	£50.74
B113476	5M 5-35mm	1	£90.38

Spiral Flute Step Drills

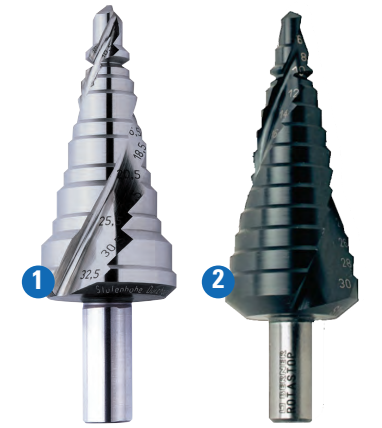

- For burr-free drilling cylindrical holes in panels, profiles and pipes up to 4mm thick
- Sided deburring of sheet metal up to 1.5mm thickness via special deburring zone

Part No.	Description	Qty	Price
B631930	4-12mm HSS	1	£12.06
B881163	4-20mm HSS	1	£20.97
B881180	6-30mm HSS	1	£30.60
B881198	6-36mm HSS	1	£49.90
B171318	4-12mm HSS TiAlN	1	£30.49

3pc HSS Spiral Flute Step Drill Set



- The split point means you don't have to pre-centre or pre-drill

Contents

- 4-12mm
- 4-20mm
- 6-30mm

£72.32

Part No. B219314

25pc 1-13mm TOPLine Silver Drills Assortment



- Suitable for construction steel up to a tensile strength of 1000N/mm², cast iron, non-ferrous metals
- Can be used with hand or column drills
- High stability and fracture resistance
- Diamond shaped split point means that you do not need to exert any force on the workpiece for centring
- 130° point angle ensures that the drill is stable and drills cleanly round holes
- The drill does not get stuck as the outside diameter gradually decreases from tip to shank
- High stability and less vibration
- The core diameter increases in the direction of the shaft
- The full working length of the drill can be reground

Contains 1mm - 13mm in increments of 0.5mm

£67.34

Part No. B130748

19pc 1-10mm TOPLine Silver 338 Twist Drill Set



- 1.0 - 10.0mm (0.5mm increments)
- DIN338

£40.69

Part No. B130747

Slugger Bits (Broach Cutters)

- These HSS annular hole cutters, offer fast and accurate hole drilling, are complete with a Weldon shank and are available in two lengths, 25mm and 50mm
- The unique cutting teeth design delivers peak performance, extending work-life



Short

Part No.	Size	Qty	Price	Part No.	Size	Qty	Price
400410	12mm	1	£13.76	400438	26mm	1	£24.45
400412	13mm	1	£14.00	400440	27mm	1	£25.34
400414	14mm	1	£14.26	400442	28mm	1	£28.12
400416	15mm	1	£14.55	400444	30mm	1	£29.90
400418	16mm	1	£15.05	400446	32mm	1	£31.44
400420	17mm	1	£15.74	400448	33mm	1	£34.35
400422	18mm	1	£16.19	400450	34mm	1	£35.15
400424	19mm	1	£16.73	400452	35mm	1	£36.23
400426	20mm	1	£18.61	400454	36mm	1	£37.13
400428	21mm	1	£19.21	400456	38mm	1	£40.35
400430	22mm	1	£20.00	400458	40mm	1	£45.14
400432	23mm	1	£20.59	400460	42mm	1	£49.46
400434	24mm	1	£22.02	400462	45mm	1	£53.71
400436	25mm	1	£23.76	400464	50mm	1	£63.86

Long

Part No.	Size	Qty	Price	Part No.	Size	Qty	Price
400466	12mm	1	£19.80	400494	26mm	1	£31.46
400468	13mm	1	£20.54	400496	27mm	1	£36.39
400470	14mm	1	£21.09	400498	28mm	1	£37.38
400472	15mm	1	£21.68	400500	30mm	1	£39.84
400474	16mm	1	£22.18	400503	32mm	1	£42.08
400476	17mm	1	£22.97	400504	34mm	1	£46.29
400478	18mm	1	£23.72	400506	35mm	1	£48.71
400480	19mm	1	£24.99	400508	36mm	1	£50.74
400482	20mm	1	£26.73	400510	38mm	1	£55.44
400484	21mm	1	£27.72	400512	40mm	1	£60.34
400486	22mm	1	£28.71				
400488	23mm	1	£29.95				
400490	24mm	1	£31.82				
400492	25mm	1	£33.42				

40mm Industrial Magnetic Drill

- Ideal portable drilling solution equally suited for use in building sites or the workshop environment and can be used to cut in horizontal, vertical and overhead positions
- The magnetic drill uses an annular hole cutter (sometimes called a slugger bit) to cut clean and accurate holes without pre-drilling or step drilling
- After cutting through the steel the cutter produces a "slug" (a cylindrical lump of steel) that falls from the centre of the cut

- Maximum cutting capacity: 40mm
- Maximum cutting depth: 30mm
- Magnetic Adhesion: 4000N/1428kg
- Motor: 1500W
- No Load Speed: 800rpm



Part No.	Description	Dimensions	Weight	Qty	Price
400400	110V	250 x 80 x 340mm	10.25kg	1	£513.81
400402	230V	250 x 80 x 340mm	10.25kg	1	£513.81

5pc Carbide Burr Set

- For increasing boreholes, milling sheet metal overlaps, removing rust, grinding edges and milling welds
- 6mm shank



Contents

- ZYAS Cylindrical
- KUD Ball-shaped
- KEL Tree-shaped with Round End
- WRC Cylindrical Round End
- SPG Pointed Tree-shaped Burr

£92.22

Part No. B175741

12mm WRC Cylindrical Round End ALU Burr (Shank 6mm)



£42.45

Part No. B175740

12mm ZYAS Cylindrical ALU Burr (Shank 6mm)



£35.64

Part No. B175739

Cylindrical Burrs

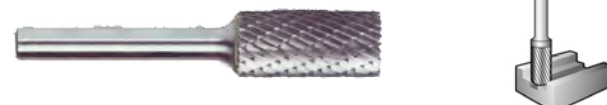

Part No.	Description	Qty	Price
B145672	8mm ZYAS Cylindrical Burr (Shank 6mm)	1	£13.17
B145666	12mm ZYAS Cylindrical Burr (Shank 6mm)	1	£22.29

Ball-shaped Burrs



Part No.	Description	Qty	Price
B145669	6mm KUD Ball-shaped Burr (Shank 6mm)	1	£11.70
B024472	12mm KUD Ball-shaped Burr (Shank 6mm)	1	£14.51

Cylindrical Round End Burrs



Part No.	Description	Qty	Price
B150515	6mm WRC Cylindrical Round End Burr (Shank 6mm)	1	£10.37
B145667	8mm WRC Cylindrical Round End Burr (Shank 6mm)	1	£12.89
B150516	10mm WRC Cylindrical Round End Burr (Shank 6mm)	1	£15.85
B145668	12mm WRC Cylindrical Round End Burr (Shank 6mm)	1	£21.1

Oval-shaped Burrs



Part No.	Description	Qty	Price
B739502	12mm TRE Oval-shaped Burr (Shank 6mm)	1	£21.76

12mm KEL Tree-shaped Burr with Round End (Shank 6mm)

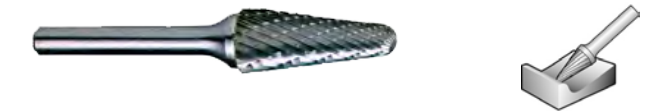

£18.32

Part No. B175742

12mm SPG Tree-shaped Burr with Pointed End (Shank 6mm)



£12.68

Part No. B145673

RBF Tree-shaped Burrs with Round Ends (Shank 6mm)

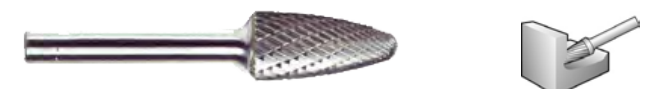

Part No.	Description	Qty	Price
B150522	8mm RBF Tree-shaped Burr with Round End (Shank 6mm)	1	£11.84
B145665	10mm RBF Tree-shaped Burr with Round End (Shank 6mm)	1	£13.68
B145674	12mm RBF Tree-shaped Burr with Round End (Shank 6mm)	1	£21.13

M5 to M12 Thread Repair Kit



- Includes: M5, M6, M8, M10, M12, 1 tap, 1 turning tool, 1 wire breaker and 10 threaded springs

£190.49

Part No. B146184

Threaded Insert



- For strengthening or repairing damaged threads

Part No.	Description	Qty	Price
B383539	M4 x 0.7mm x 6mm	10	£7.44
B383540	M5 x 0.8mm x 7.5mm	10	£7.44
B383550	M6 x 1.0mm x 6mm	10	£7.44
B399080	M6 x 1.0mm x 9mm	10	£7.44
B399081	M6 x 1.0mm x 12mm	10	£7.44
B399082	M8 x 1.25mm x 8mm	10	£7.44
B399083	M8 x 1.25mm x 12mm	10	£7.44
B399084	M8 x 1.25mm x 16mm	10	£7.44
B399085	M10 x 1.25mm x 10mm	10	£7.44
B399086	M10 x 1.25mm x 15mm	10	£7.44
B399087	M10 x 1.5mm x 10mm	10	£7.44
B399088	M10 x 1.5mm x 15mm	10	£7.44
B399089	M10 x 1.5mm x 20mm	10	£7.44
B399090	M10 x 1.5mm x 25mm	10	£7.44
B399091	M12 x 1.25mm x 18mm	10	£7.94
B399092	M12 x 1.5mm x 12mm	10	£7.44
B399093	M12 x 1.5mm x 18mm	10	£7.94
B399094	M12 x 1.75mm x 18mm	10	£4.94
B399095	M12 x 1.75mm x 24mm	10	£7.44
B399096	M14 x 1.25mm x 8.4mm	5	£5.45
B399097	M14 x 1.25mm x 12.4mm	5	£5.45
B399098	M14 x 1.25mm x 16.4mm	5	£5.45
B399099	M14 x 1.5mm x 21mm	5	£5.94
B399100	M16 x 1.5mm x 21mm	5	£7.63

HSS Cutting Nut



- For cutting new external threads, extending external threads, re-cutting damaged threads and cleaning dirty threads (rust, paint etc.)

Part No.	Description	Qty	Price
B032537	M5 x 0.8mm	1	£18.37
B027457	M6 x 1.0mm	1	£18.37
B032538	M8 x 1.0mm	1	£15.83
B027456	M8 x 1.25mm	1	£17.14
B032536	M10 x 1.25mm	1	£21.33
B027466	M10 x 1.5mm	1	£24.22
B032541	M12 x 1.25mm	1	£30.51
B032542	M12 x 1.5mm	1	£28.63
B027460	M12 x 1.75mm	1	£29.23
B032549	M14 x 1.5mm	1	£35.54
B032550	M14 x 2.0mm	1	£35.54
B032551	M16 x 1.5mm	1	£58.51
B032527	M16 x 2.0mm	1	£58.51

HSS Hex Die Nut



- For general use, non abrasive materials up to 900 N/mm², unalloyed and low alloyed steel for thread cutting by hand and machine

Part No.	Description	Qty	Price
728282	M8	1	£18.77
728286	M10	1	£22.30
728290	M12	1	£23.82

M3 to M10 HSS TiN Combination Tap Set



- Includes: Combination tap, M3, M4, M5, M6, M8 and M10 + adapter

£116.80

Part No. B187039

HSS TiN Combination 6 Sided Tap



- Drilling, tapping and deburring in one operation

Part No.	Description	Qty	Price
B187033	M3	1	£21.45
B187034	M4	1	£21.45
B187035	M5	1	£21.45
B187036	M6	1	£21.45
B187037	M8	1	£28.80
B187038	M10	1	£32.79

M3 to M10 HSS Short Machine Tap Bit Set



- Includes: M3, M4, M5, M6, M8 & M10 threaded tap bits as well as magnetic bit holder

£36.94

Part No. B059000

HSS Short Tap Bit



- For use with slowly rotating drills clockwise or anti-clockwise

Part No.	Description	Qty	Price
B059001	M3	1	£6.59
B059002	M4	1	£6.59
B059003	M5	1	£8.23
B059004	M6	1	£8.78
B059005	M8	1	£12.52
B059006	M10	1	£14.62

8pc M3 to M45 Screw Extractor Set



- For unscrewing broken bolts and screws
- Square mount for placement in ring spanner or tap wrench

£44.42

Part No. B067040

5pc M3 to M18 Screw Extractor Set



- For unscrewing broken bolts and screws
- Square mount for placement in ring spanner or tap wrench

£21.71

Part No. B067024

Stud Extractor Set 1-5



- For removal of broken studs and bolts
- No. 1-5 screw extractor
- Tapered drill sizes: 4, 5, 5.5, 7.5 & 10mm
- Adjustable "T" type tap wrench M3 - M6
- Adjustable "T" type tap wrench M6 - M12

£126.02

Part No. 727900

Threaded Bush & Screw In Tool



- Good anchoring of external threads
- Internal metric thread for common screws
- No requirement to pre tap so saves time as the bushes are self-tapping
- With external chamfering with 2 grooves with sharp edges so less effort required

- Can be used with the following materials:
- Light alloys
 - Cast iron, brass, bronze, NF metals
 - Plastics, laminates
 - Hardwoods



Threaded Bush



Part No.	Description	Drilling Ø	Qty	Price
B399102	M4 x 0.7mm	5.9mm	10	£7.18
B399103	M5 x 0.8mm	7.2mm	10	£7.59
B399104	M6 x 1mm	8.8mm	10	£8.58
B399105	M8 x 1.25mm	10.8mm	10	£10.48
B399106	M10 x 1.5mm	12.8mm	10	£15.21
B399107	M12 x 1.75mm	14.8mm	10	£21.01
B399108	M14 x 2mm	16.8mm	10	£23.33

Threaded Bush Screw In Tool



Part No.	Description	Qty	Price
B011164	M4	1	£62.73
B341622	M5	1	£71.57
B341630	M6	1	£77.91
B341639	M8	1	£96.77
B341657	M10	1	£112.99
B118269	M12	1	£107.33
B112270	M14	1	£119.70

Thread Repair Kits



- 1 drill bit
- 1 tap
- 1 insert tool
- 1 lug breaking tool
- 10 thread inserts

Part No.	Description	Qty	Price
B145896	M4 x 0.7mm	1	£31.13
B145897	M5 x 0.8mm	1	£33.77
B145898	M6 x 1mm	1	£34.28
B145899	M8 x 1.25mm	1	£35.07
B145900	M10 x 1.5mm	1	£39.50
B147106	M12 x 1.25 x 18mm	1	£40.88
B147105	M12 x 1.5 x 18mm	1	£40.37
B122846	M12 x 1.75 x 18mm	1	£37.52
B122847	M14 x 1.25 x 21mm	1	£34.16
B147107	M14 x 1.5 x 21mm	1	£37.04
B147108	M16 x 1.5 x 24mm	1	£42.46

HSS Metric Coarse Taps Taper Taps



- For non-abrasive material up to 900 N/mm², unalloyed and low alloyed steel, for through and blind holes, to be used by hand or cordless power tool

Part No.	Description	Qty	Price
727510	M4 x 0.7mm	1	£3.77
728502	M5 x 0.8mm	1	£4.32
727530	M6 x 1mm	1	£4.58
728508	M8 x 1.25mm	1	£5.04
728512	M10 x 1.5mm	1	£5.46
728516	M12 x 1.75mm	1	£13.05

Second Taps



- For non-abrasive material up to 900 N/mm², unalloyed and low alloyed steel, for through and blind holes, to be used by hand or cordless power tool

Part No.	Description	Qty	Price
728518	M4 x 0.7mm	1	£3.74
728520	M5 x 0.8mm	1	£3.82
728522	M6 x 1mm	1	£4.93
728526	M8 x 1.25mm	1	£5.62
728530	M10 x 1.5mm	1	£6.66
728534	M12 x 1.75mm	1	£8.84

Bottom Taps



- For non-abrasive material up to 900 N/mm², unalloyed and low alloyed steel, for through and blind holes, to be used by hand or cordless power tool

Part No.	Description	Qty	Price
727500	M4 x 0.7mm	1	£3.92
727520	M5 x 0.8mm	1	£4.17
728540	M6 x 1mm	1	£4.40
728544	M8 x 1.25mm	1	£4.90
727540	M10 x 1.5mm	1	£6.03
727550	M12 x 1.75mm	1	£8.17

3pc HSS Tap Sets



- For tapping inner thread in through and blind holes
- 3-part set: Taper, second and bottom
- For metric ISO thread DIN 13
- Metric standard thread, HSS material

Part No.	Description	Qty	Price
B045730	M3 x 0.5mm	1	£9.65
B045748	M4 x 0.7mm	1	£9.65
B045756	M5 x 0.8mm	1	£9.65
B045764	M6 x 1mm	1	£9.65
B045772	M7 x 1mm	1	£11.19
B045780	M8 x 1.25mm	1	£11.32
B045802	M10 x 1.5mm	1	£12.76
B045810	M12 x 1.75mm	1	£16.30
B045829	M14 x 2mm	1	£18.89
B045837	M16 x 2mm	1	£19.54
B223212	M18 x 2.5mm	1	£24.15
B223743	M20 x 2.5mm	1	£25.14
B223751	M22 x 2.5mm	1	£26.32

HSGT Tap Sets



- For non-abrasive material up to 900 N/mm², unalloyed and low alloyed steel, for through and blind holes, to be used by hand or cordless power tool

Part No.	Description	Qty	Price
728253	M5	1	£16.04
728258	M6	1	£17.69
728262	M8	1	£18.44
728266	M10	1	£19.54
728270	M12	1	£26.68

Ratchet Tap Handle (DIN377)



- For tapping in hard-to-reach places
- With double jaw chuck for holding square shanks
- DIN377

Part No.	Description	Qty	Price
B228117	M3 to M10 - 85mm	1	£11.73
B228249	M5 to M12 - 100mm	1	£14.42
B083330	M5 to M12 G1/8 - 300mm	1	£22.56

View our latest product videos on our YouTube channel or online at unitedindustrial.co.uk

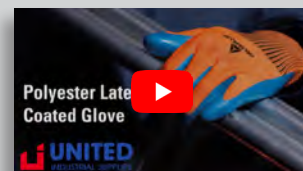

44pc M3 to M12 DIN352 Tap and Die Set



Contents

- Hand taps (pre-cutter, mid-cutter and after-cutter) in accordance with DIN 352: M3, M4, M5, M6, M8, M10, M12
- Dies in accordance with DIN 223 / EN 22568: M3, M4, M5, M6, M8, M10, M12
- Die Stocks: 20 x 5, 20 x 7, 25 x 9, 30 x 11, 38 x 14
- Tap Wrenches: no. 1 and no. 2
- Thread gauge
- 1 slotted screwdriver

£107.80

Part No. B041602

61pc M3 to M12 DIN371 Tap and Die Set



Contents

- Hand taps DIN 352 M3-M12, front cutter, centre cutter and after-cutter
- Machine taps DIN 371 form B M3-M10, DIN 376 form B M12
- Dies: M3-M12
- Guides: M3-M12
- Die Stocks: 20x5, 20x7, 25x9, 30x11, 38x14
- Adjustable wrenches DIN 1814 size 1 and size 2
- Manual deburrer 12.4 mm Twist drill bits
- DIN 338 Ø 2.5 - 3.3 - 4.2 - 5 - 6.8 - 8.5 - 10.2mm
- Tool holder size 2
- Cutting paste 20g
- Screwdriver
- Thread gauge

£317.09

Part No. B187040

52pc M3 to M20 DIN223 Tap and Die Set



Contents

- Hand tap set according to DIN 352: M3, M4, M5, M6, M8, M10, M12, M14, M16, M18, M20
- Dies according to DIN 223 / EN 22568: M3, M4, M5, M6, M8, M10, M12, M14, M16, M18, M20
- Die Stocks: 20 x 5, 20 x 7, 25 x 9, 30 x 11, 38 x 14, 45 x 18
- Tap Wrenches: no. 1 and no. 3
- Thread gauge
- 1 slotted screwdriver

£328.90

Part No. B559580

52pc M3 to M12 HSS Tap and Die Set



Contents

- Hand taps HSS: 3 each of M3, M4, M5, M6, M8, M10 and M12
- Dies HSS M3, M4, M5, M6, M8, M10, M12
- Die Stocks: 20x5, 20x7, 25x9, 30x11, 38x14
- Adjustable Tap Wrenches: Nr. 1 + Nr. 2
- Twist drill bits HSS-G 2.5, 3.3, 4.2, 5.0, 6.8, 8.5, 10.2
- Guides for dies M3, M4, M5, M6, M8, M10, M12
- Threading Manual
- Tap handle M4-M10

£132.00

Part No. B335573

45pc M3 - M12 Coarse Tap & Die Set

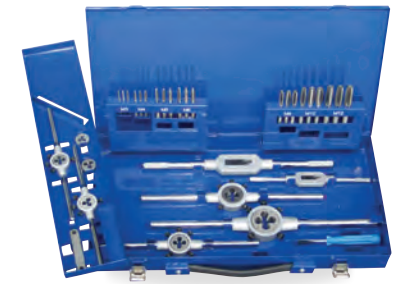

Contents

- 3 part hand taps in sizes M3, M4, M5, M6, M8, M10 & M12, all for through and blind holes
- Corresponding core hole drilling bits for each tap set
- Adjustable Tap wrenches
- Die Stocks
- Screwdriver

£147.99

Part No. 911966

15pc M3 - M12 Metric Thread Tap Set



Contents

- 1-Piece hand tap in M3, M4, M5, M6, M8, M10 & M12 taps for metric ISO thread DIN13
- 2.5, 3.3, 4.2, 5, 6.8, 8.5 & 10.2mm DIN338 twist drills that correspond to drilling size of each tap
- Tap wrench

£49.94

Part No. B932491

7pc M3 to M12 DIN371/376 Standard Machine Tap Set

- For cutting internal threads for blind holes
- DIN 371: M3 to M10 with reinforced shaft
- DIN 376: M12 with tapered shaft
- Machine taps: M3, M4, M5, M6, M8, M10, M12
- In a sturdy plastic box

£63.36

Part No. B186728

7pc M3 to M12 DIN371 Form C Vaporized Blue Ring Machine Tap Set

Blue Ring for Stainless Steel

- For cutting internal threads in stainless steel spiral flutes
- DIN 371: M3 to M10 with reinforced shank
- DIN 376: M12 with tapered shank
- Machine taps: M3, M4, M5, M6, M8, M10, M12
- In a sturdy plastic box

£133.71

Part No. B186875

7pc M3 to M12 DIN371B Vaporized Blue Ring Machine Tap Set

Blue Ring for Stainless Steel

- For cutting internal threads in stainless steel straight flutes
- DIN 371: M3 to M10 with reinforced shank
- DIN 376: M12 with tapered shank
- Machine taps: M3, M4, M5, M6, M8, M10, M12
- In a sturdy plastic box

£120.09

Part No. B186869

7pc M3 to M12 DIN371/376B Red Ring Machine Tap Set

 Red Ring for Alloys up to 1400N/mm²

- High performance taps for alloys up to max. 1400N/mm²
- DIN 371: M3 to M10 with tapered shaft
- DIN 376: M12 with tapered shaft
- Machine taps: M3, M4, M5, M6, M8, M10 and M12
- In a sturdy plastic box

£110.50

Part No. B186800

7pc M3 to M12 DIN371/376C Yellow Ring Machine Tap Set

 Yellow Ring for universal use up to 1000N/mm²

- For universal use up to 1000N/mm²
- DIN 371: M3 to M10 with tapered shaft
- DIN 376: M12 with tapered shaft
- Machine taps: M3, M4, M5, M6, M8, M10, M12
- In a sturdy plastic box

£105.36

Part No. B186765

7pc M3 to M12 DIN371/376C TiAlN Machine Tap Set

- For extremely hard materials
- DIN 371: M3 to M10 with tapered shank
- DIN 376: M12 with tapered shank
- Machine taps: M3, M4, M5, M6, M8, M10, M12
- In a sturdy plastic box

£98.12

Part No. B186920

Bench Grinder 150mm 450W/230V Heavy-Duty

- Fitted with copper wound induction motor drive
- Suitable for general workshop grinding and sharpening use
- Two aluminous oxide grinding stones, coarse and fine
- Fitted with stone guards and spark arrestors
- Eye shields included
- Supplied with 3-pin plug

£159.66

Part No. BG150XD/99

Bench Grinder Floor Stand

- Bench grinder stand with adjustable feet
- Suits a wide variety of bench grinders with central mounting holes
- Suitable for BG150XD/99
- Also suitable for other leading brands of bench grinder
- Due to variations in the base configuration on the bench grinders, some modification to the stand top plate/frame may be required
- Size (W x D x H) - 465 x 465 x 900mm, Bench Grinder Base (W x D); 270 x 220mm

£89.87

Part No. BGST

10 tonne SuperSnap® Hydraulic Body Repair Kit

- SuperSnap® kits feature snap-together pipework for speed, and threaded attachments for strength
- Connecting parts are zinc or cad plated for long, rust-free life
- Components are manufactured from high quality steel and finished with red supergloss paint
- All attachments interchange with other popular makes so you can use your existing equipment with the SuperSnap® range
- Supplied in composite storage case

£429.95

Part No. RE83/10

Infra-red Paint Drying Lamp

- Infra-Red paint drying lamp fitted 2 quick heating quartz halogen lamps, each providing 1000w of power
- Ideal for spot repairs, engine drying, adhesive strip removal, drying filler or primer, or pre-heating prior to spraying
- The low chassis & tall frame allows work to be undertaken on all parts of the vehicle
- Temperature range: 40° - 80°C; power: 2000w (1000w per lamp). Timer adjustment from 1 to 30mins
- Working distance: 500 - 700mm. Height adjustment: 200 - 1900mm
- Wide stable base, fitted with 4 swivel castors (2 with brakes) for manoeuvrability

£641.96

Part No. BT092442

 View our range of PPE on pg.244-253 as well as online at unitedindustrial.co.uk

MIRKA

Direct Electrical Random Orbital Sander

Mirka DEROS 5650CV 125/150mm 230V Random Orbital Sander



- 5mm oscillation and both a 125mm (5") and a 150mm (6") pad
- Brushless motor maintains constant speed under heavy loads
- Suitable for general sanding of all kinds of surfaces, particularly for smaller areas
- Includes plastic storage container

£513.66

Part No. 478810

Mirka DEROS 650CV & DEOS 663CV 230V Kit



- Includes: Mirka DEROS 650CV 150mm 230V Orbit 5.0, Mirka DEOS 353CV 81x133mm 230V Orbit 3.0 & Mirka Systainer Case
- DEROS 650CV & DEOS 663CV have integrated vibration sensors and are equipped with Bluetooth

£825.96

Part No. 478812

Mirka DEROS 650CV & DEOS 383CV Kit



- Includes: Mirka DEROS 650CV 150mm 230V Orbit 5.0, Mirka DEOS 383CV 70x198mm 230V Orbit 3.0 & Mirka Systainer Case
- DEROS 650CV & DEOS 383CV have integrated vibration sensors and are equipped with Bluetooth

£825.96

Part No. 478814

Mirka DEROS 650CV & DEOS 353CV Kit



- Includes: Mirka DEROS 650CV 150mm 230V Orbit 5.0, Mirka DEOS 353CV 81x133mm 230V Orbit 3.0 & Mirka Systainer Case
- DEROS 650CV & DEOS 353CV have integrated vibration sensors and are equipped with Bluetooth

£825.96

Part No. 478816

150mm Autonet Grip Discs



MIRKA Suits DEROS Range

- For the automotive refinishing industry
- This new-age surface finishing solution offers speed, excellent efficiency and an amazing dust extraction ability
- The jobs get done quicker and with a better surface quality
- Excellent initial aggressivity
- Reduces edge wear in finer grits
- Eliminates clogging and pilling
- Long life-span

Part No.	Description	Qty	Price
478630	80G	50	£29.41
478632	120G	50	£31.88
478633	150G	50	£30.39
478634	180G	50	£30.17
478636	240G	50	£33.19
478639	320G	50	£32.45
478640	400G	50	£34.90
478642	500G	50	£32.96
478644	600G	50	£33.97
478645	800G	50	£33.99

DISCS ARE ALSO AVAILABLE IN 125MM (80G TO 800G)

100 x 152 x 152 Abranet ACE HD Triangles

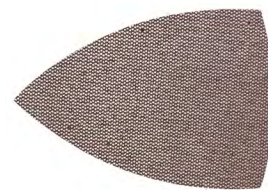

MIRKA Suits DEOS Triangle Range

Part No.	Description	Qty	Price
478991	40G	25	£53.82
478992	60G	25	£50.64
478993	80G	25	£48.51
478994	120G	25	£46.04

70 x 198mm Abranet Grip Strips



MIRKA Suits DEOS Strip Range

Part No.	Description	Qty	Price
478949	80G	50	£62.98
478950	100G	50	£57.90
478951	120G	50	£57.90
478952	150G	50	£57.90
478953	180G	50	£57.90
478954	240G	50	£57.90
478955	320G	50	£57.90
478956	400G	50	£57.90
478957	500G	50	£57.90
478958	600G	50	£57.90

STRIPS ARE ALSO AVAILABLE IN: 70 X 420MM (80G TO 500G) AND 81 X 133MM (80G TO 600G)

150mm 6 Hole Grip Discs



- Can be used for various sanding purposes
- Suited for sanding at high speeds

Part No.	Size	Qty	Price
478416S	40G	50	£23.06
478420S	80G	100	£33.56
478424S	120G	100	£31.98
478428S	180G	100	£30.31
478432S	240G	100	£30.31
478434S	320G	100	£30.31
478436S	400G	100	£30.31

150mm Abranet Grip Discs



- For sanding filler, primers, lacquers and composite materials
- Revolutionary sanding material for dust-free sanding
- Abranet® contains thousands of small holes, making it possible to effectively vacuum dust and other particles away without clogging the disc surface
- Since the amount of airborne dust has been minimised, the work environment is remarkably improved
- Durable long lasting product

Part No.	Description	Qty	Price
478628	40G	25	£41.98
478620	80G	50	£76.91
478621	100G	50	£67.27
478622	120G	50	£67.27
478623	150G	50	£67.27
478624	180G	50	£67.27
478625	240G	50	£67.27
478638	320G	50	£67.27
478626	360G	50	£67.27
478627	400G	50	£67.27
478610	500G	50	£67.27
478612	600G	50	£67.27
478613	800G	50	£67.27
478614	1000G	50	£67.27

Backing Pads



Part No.	Description	Qty	Price
1 478469	150mm 6 Hole (M8)	1	£56.12
2 478468	150mm 51 Hole (5/16)	1	£50.91

150mm UNILine 6 Hole Grip Discs

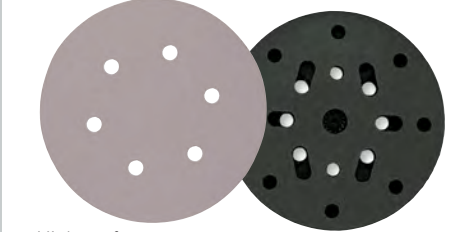

- High performance
- High quality corundum
- Flexible grinding fabric also suitable for profiled metal pieces with high edge stiffness and good edge stability

Part No.	Size	Qty	Price
B055290-50	40G	50	£13.19
B055291-50	60G	50	£13.19
B050692-50	80G	50	£13.19
B050693-50	100G	50	£13.19
B050694-50	120G	50	£13.19
B050697-50	180G	50	£13.19
B050698-50	220G	50	£13.19
B050699-50	240G	50	£13.19
B050701-50	320G	50	£13.19
B050702-50	400G	50	£13.19
B263575	150mm Backing Pad	1	£21.25

180mm Aloxide Sanding Discs



- For use on mild steel, iron, sheet steel & wood
- Unique resin bond holds the grit to the disc surface
- Heavy-duty fibre backing for increased strength, durability & tear resistance

Part No.	Description	Qty	Price
478262	24G	25	£34.02
478266	36G	25	£31.65

Fibre Discs 36G



- For stock removal on carbon and mild steel e.g. door skin removal to flange and MIG weld grinding

Part No.	Description	Qty	Price
478291	100 x 16mm	25	£14.98
478249	115 x 22mm	25	£48.17

Flat Metal Cutting Discs



Part No.	Description	Brand	Qty	Price
B38272-25	75 x 1.2 x 10mm	Berner	25	£31.42
B154814-25	75 x 2 x 10mm	Berner	25	£30.76
630231	76 x 1.6 x 10mm	Abracs	1	£1.25
630233	100 x 1 x 16mm	Abracs	1	£1.33
B38274-25	115 x 1.6 x 22.2mm	Berner	25	£32.91
630237	115 x 2.5 x 22mm	Abracs	25	£20.75
B038280-25	230 x 1.9 x 22.3mm	Berner	25	£63.24
B38283-10	300 x 3.5 x 20mm	Berner	10	£48.55

DPC Metal Cutting Discs



Part No.	Description	Brand	Qty	Price
630209	100 x 3 x 16mm	Abracs	1	£0.85
630210	100 x 3 x 16mm	Abracs	25	£21.20
630214	115 x 3 x 22mm	Abracs	10	£10.48
B38275-25	115 x 3 x 22.23mm	Berner	25	£24.44
B38279-25	125 x 3 x 22.23mm	Berner	25	£24.24
630218	178 x 3.2 x 22mm	Abracs	10	£14.81
702915	230 x 3.2 x 22mm	Abracs	10	£19.01

Inox Flat Cutting Discs



Part No.	Description	Brand	Qty	Price
630242	75 x 1 x 10mm	Abracs	1	£1.22
B38496-25	115 x 1 x 22mm	Berner	25	£27.85
B38500-25	125 x 1 x 22mm	Berner	25	£29.06

DPC Grinding Discs



Part No.	Description	Brand	Qty	Price
630226	100 x 6 x 16mm	Abracs	10	£11.21
B038303-10	115 x 6 x 22mm	Berner	10	£12.17
B038304-10	125 x 6 x 22mm	Berner	10	£13.54
B38305-10	230 x 6 x 22mm	Berner	10	£30.68

75 x 0.8 x 9.5mm Flexi-Cut Cutting Disc

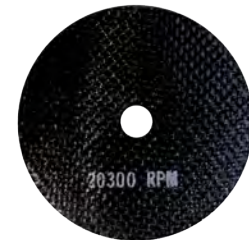

- Ideal for preparing, cut-off notching and slotting and grinding out defects on a wide range of materials

£7.59

Part No. 630228

10 x 330mm Abrasive Belts



- For grinding, deburring, removing rust, paint, etc.
- Suitable for steel, stainless steel, metal and non-ferrous metals

Part No.	Description	Qty	Price
B052749-10	40G	10	£17.95
B052750-10	60G	10	£11.51
B836672-10	80G	10	£18.79
B111622-10	120G	10	£12.82

20 x 520mm Abrasive Belts



- For grinding, deburring, removing rust, paint, etc.
- Suitable for steel, stainless steel, metal and non-ferrous metals

Part No.	Description	Qty	Price
478279	40G	10	£9.15
SA355/B60G	60G	5	£11.92
478281	60G	10	£19.06
SA355/B80G	80G	5	£11.92

Zirconium Flap Discs

- Flexible
- Suitable for distorted surfaces and hard to reach areas
- Can be used without a pad
- Grain: zirconium corundum

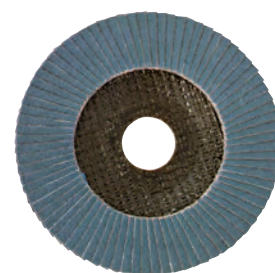

Part No.	Description	Qty	Price
660952	100 x 16mm 40G	10	£29.55
B050896-10	115 x 22mm 40G	10	£27.95
660961	100 x 16mm 60G	10	£27.23
B050897-10	115 x 22mm 60G	10	£27.39
B050907-10	125 x 22mm 60G	10	£27.73
B050898-10	115 x 22mm 80G	10	£26.91

Wire Brushes with 6mm Shanks



Part No.	Description	Qty	Price
B023015	5pc Set with 6mm Shank	1	£17.44
B023011	Dia. 17mm Length 65mm	1	£3.99
B023010	Dia. 25mm Length 75mm	1	£4.32
B023014	50mm Wire Cup Brush	1	£8.97
B137057	50mm Circular Brush	1	£4.07
B023013	75mm Circular Brush	1	£4.65

80 x 15mm Inox Mounted Wire Brush Wheel with 6mm Shank - Pack of 10



- Universally applicable for cleaning, derusting, smoothing, cleaning weld seams, light deburring and removing corrosion and paint
- Optimal adaptation to the contour of the workpieces thanks to high flexibility

£118.04

Part No. 630219

15mm Round Stainless Steel Wire Brush - 6mm Shank



- For processing of stainless steel surfaces
- Faster material removal
- Twisted stainless steel wire

£19.62

Part No. B099907

22mm Wire brush tip - 6mm Shank



- For processing of stainless steel surfaces
- Faster material removal
- Twisted stainless steel wire

£35.96

Part No. B099909

Encapsulated Steel Wire Round Brush with 6mm Shank

- Removes rust from body parts
- Suitable for electric and pneumatic drilling machines

£22.14

Part No. B150794

115mm Cleaning Disc with Integrated Backing Pad

- To remove rust, old coatings, sealant residue, etc

£14.82

Part No. B405722

Rust Removal Discs & Backing Pad



- Suitable for grinding right into corners, across contours and in hard to reach areas
- Ideally suitable for preparation and cleaning of welds, rust removal and removal of discolouration
- Backing Pad M14 Thread

Part No.	Description	Qty	Price
1 478002	75mm HD Disc	1	£3.39
2 478005	100mm Disc	1	£9.33
3 478004	M14 Backing Pad	1	£20.47

50mm Roloc Discs



Part No.	Description	Qty	Price
B017826-4	Green 50G	4	£27.61
B017827-4	Yellow 80G	4	£27.61
B017828-4	White 120G	4	£27.61
478269	Sanding Disc 80G	10	£22.46
B139508	Backing Pad (6mm Shank)	1	£9.75

Aluminium Alloy Grinding Wheel Dresser & Repair Kit



Part No.	Description	Qty	Price
1 775442	Dresser	1	£11.3
2 775446	Repair Kit	1	£3.84

Grinding Stones



- Suitable for all general purpose applications
- Aluminous oxide stone
- Fit 13mm axles

Part No.	Description	Qty	Price
680202	150 x 20 x 32mm Coarse	1	£11.95
680204	200 x 25 x 16mm Fine	1	£21.01

Wire Wheels



- Suitable for general workshop descaling/cleaning operations
- Brass coated steel wire wheel

Part No.	Description	Qty	Price
680222	150 x 19 x 13mm	1	£24.95
680224	200 x 13 x 16mm	1	£25.45

25 x 20mm Bibielle Flap Wheels 60g



- Aluminium oxide cloth
- 6mm shaft
- Pack of 4

£20.23

Part No. VANWAF226

Flap Wheels - 6mm Shank



- For use on steel, stainless steel and non-ferrous metal, wood, plastic, varnish and lacquer
- Blades are placed in a fan-shape around the pin

Part No.	Description	Qty	Price
B017331	20 x 20mm Dia. 80G	1	£3.27
B050937	25 x 10mm Dia. 80G	1	£3.48
B050939	25 x 15mm Dia. 80G	1	£3.55
B016098	30 x 10mm Dia. 60G	1	£3.55
B016100	30 x 10mm Dia. 80G	1	£3.55
B016099	30 x 10mm Dia. 120G	1	£3.72
B016097	40 x 15mm Dia. 80G	1	£3.82
B146868	40 x 15mm Dia. 120G	1	£4.07
HCRG0273	40 x 30mm Dia. 40G	1	£3.88
B146867	40 x 30mm Dia. 60G	1	£4.11
B146869	50 x 20mm Dia. 60G	1	£4.69
B146871	50 x 20mm Dia. 120G	1	£4.96
B016101	60 x 20mm Dia. 60G	1	£5.04
B016108	60 x 20mm Dia. 80G	1	£5.26
B146872	60 x 30mm Dia. 60G	1	£5.48
B807176	60 x 30mm Dia. 80G	1	£9.20
B146873	60 x 30mm Dia. 120G	1	£9.35
B146874	80 x 30mm Dia. 60G	1	£9.42
B807184	80 x 30mm Dia. 80G	1	£14.04
B146875	80 x 30mm Dia. 120G	1	£14.27

Fleece Grinders - 6mm Shank



- For use on steel, stainless steel and non-ferrous metal, wood, plastic, varnish and lacquer
- Highly flexible structure

Part No.	Description	Qty	Price
B146876	60 x 30mm Dia. 120G	1	£13.19
B146877	60 x 30mm Dia. 160G	1	£14.01
B146878	80 x 50mm Dia. 120G	1	£18.27
B146879	80 x 50mm Dia. 160G	1	£19.02

Steel Wool Medium Grade



- For cleaning & deburring pipes, preparing pipework before soldering and applying flux
- High grade steel
- Great for contours of ovnote surface
- 450g

£5.56

Part No. 700109

152 x 229mm Finishing Pads



Part No.	Description	Qty	Price
478501	Purple Scotchbrite Very Fine	20	£49.73
478504	Maroon Finish Very Fine	20	£16.65
478509	Grey Fine	20	£15.68

230 x 280mm Wet & Dry Paper Sheets



Part No.	Grit	Brand	Qty	Price
478206	80G	Mirka	50	£53.01
B050533-50	120G	Berner	50	£17.00
B050536-50	180G	Berner	50	£18.06
478223	240G	Abracs	50	£18.62
478216	280G	Abracs	50	£18.36
B050540-50	320G	Berner	50	£17.50
B050542-50	400G	Berner	50	£16.47
478186	600G	Abracs	50	£18.36
478190	800G	Abracs	50	£18.36
478194	1200G	Abracs	50	£18.36

230 x 280mm Emery Cloth Sheets



- For metal and wood
- Flexible sanding
- Special cotton fabric
- Ability to rip horizontally and vertically
- Normal corundum, semi-open spread

Part No.	Grit	Brand	Qty	Price
B50586-25	60G	Berner	25	£17.14
B050587-50	80G	Berner	50	£36.78
B050588-50	100G	Berner	50	£30.81

100mm x 10m Purple Roll Very Fine



- Used with lacquer, plastic, wood & metal
- Mirlon
- Disc/Grain: VF 360

£66.26

Part No. 478502

50mm x 50m Aloxide Brown Emery Rolls

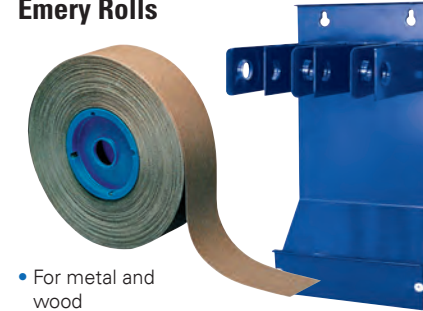

- For metal and wood

Part No.	Description	Qty	Price
B050596	60G	1	£31.25
B050597	80G	1	£31.74
B050598	100G	1	£28.18
B050599	120G	1	£27.17
B050602	240G	1	£27.96
B100099	Dispenser	1	£43.14

115mm x 50m Production Paper Roll



- For use on wood, metal fillers & painted surfaces
- Manufactured using premium quality grain & sturdy, durable E-weight paper backing
- Resin coated to resist heat and humidity
- Suitable for both hand & machine sanding

Part No.	Grit	Qty	Price
478822	40G	1	£36.42
478826	80G	1	£42.14

25mm x 50m Aloxide Emery Roll



Part No.	Description	Qty	Price
478242	40G Brown	1	£15.38
478240	60G Blue	1	£19.35
478238	80G Blue	1	£19.35
478234	100G Blue	1	£16.69
478261	120G Brown	1	£16.31

PERSONAL PROTECTION

Protect you and your employees from health & safety risks at work with our range of eye protection, safety footwear, hi-visibility clothing, face coverings and ear protection.



SEE PAGE 244-253 FOR OUR FULL RANGE

500ml Wheel Spray Paints

- High quality, fast drying acrylic paint with good spray characteristics
- For steel and aluminium wheels and hubcaps
- Weather resistant, light proof and UV resistant
- Good colour and gloss retention
- Excellent surface hardness and good elasticity
- Limited fuel-resistance



Part No.	Description	Qty	Price
547500	Steel Wheels	1	£5.44
547501	Silver Wheels	1	£5.44

500ml Stone Chip Sprays

- Excellent corrosion protection
- Long lasting elasticity
- Noise insulation
- Excellent adhesion
- Overcoatable
- Resistant to acids and alkalines
- Good weathering resistance



Part No.	Description	Qty	Price
547520	Black Stone Chip	1	£9.61
547521	Grey Stone Chip	1	£9.61
547522	White Stone Chip	1	£9.61

500ml Spray Paints

- Fast drying product with good spray characteristics
- Suitable for most surfaces
- Weather resistant, light proof and UV resistant
- Scratch and impact resistant
- Excellent surface hardness and good elasticity
- Can be mechanically polished



Part No.	Description	Qty	Price
547503	Satin Black	1	£5.44
547504	Gloss Black	1	£5.44
547505	Matt Black	1	£5.44
547508	Gloss White	1	£5.44

500ml Clear Lacquer

- Fast drying product with good spray characteristics
- Suitable for internal and external use
- Weather resistant, light proof and UV resistant
- Scratch and impact resistant
- Excellent surface hardness and good elasticity
- Can be mechanically polished



£5.44
Part No. 547507

500ml Primer Sprays

- Fast drying acrylic primer filler
- Good corrosion protection
- Optimizes the gloss finish of the topcoat
- Good spraying properties and good coverage
- Excellent adhesion of subsequent topcoat
- Excellent filling properties and easy to sand
- Will adhere to wood, metal, aluminium and many other substrates



Part No.	Description	Qty	Price
547502	Grey	1	£5.44
547506	White	1	£5.44

500ml Quick Drying Acid Etching Primer

- Excellent etching properties
- Adhesion direct onto substrates including; alloy, stainless steel, zinc and galvanise
- Quick Dry allows faster throughput
- Super smooth finish



£15.83
Part No. 610279

500ml White High Build Primer Filler

- High build primer filler
- Fast drying
- Excellent smooth finish
- Very easily sanded
- Supplied with 2 nozzles



£15.01
Part No. 547021

400ml Zinc Aluminium Spray

- Protects metal parts against weather, water and salt
- Added aluminum gives machined surface a silver effect
- Resistant to petrol, oil and seawater
- Fast drying
- Automotive, bodywork processing plants, central heating, air conditioning and duct construction, metalworking companies and industries



£7.25
Part No. B407708

400ml Red Primer Rust Stop

- Quick-drying rust stop primer (mix)
- Prevents corrosion, even in already affected areas
- Free of heavy metals and acids
- Primer for metal parts (galvanised) iron, steel and concrete
- Automotive, bodywork processing companies, engineering companies and industry
- Temperature resistance: 120°C



£5.29
Part No. B091586

500ml Ultimate Grip Primer Aerosol

- Advanced adhesion promoter for difficult substrates
- It provides a clear 'nano' coating that allows further coatings to be applied to these difficult substrates
- The product has been tested on substrates such as plastic, non ferrous metal including aluminium and stainless steel as well as glass, porcelain and E coat substrates
- Excellent adhesion to Alu, Galvanised and Stainless Steel and Hard Plastics
- Nano film - low film build
- Can be overcoated with all other primers



£13.81
Part No. 547706

400ml VHT Topcoat

- Very High Temperature topcoat gives ultimate protection up to 800°C, proves extremely successful for treated and untreated surfaces exposed to very high temperatures
- It is suitable for use on flues and pipework. It can be sprayed onto bare metal without the need to prime first
- Good coverage and filling properties
- Excellent adhesion to steel, mild steel and aluminium
- Resistant to petrol, chemicals and weather
- 100% free of heavy metals



Part No.	Description	Qty	Price
547700	Black	6	£67.30
547702	Clear	6	£67.30
547704	Silver	6	£67.30

400ml HB 360 Aerosol Primer

- HB Body Fill 360 High solids 2K Primer in 400ml Aerosol.
- No messy primer gun to clean each time
- Ideal for priming SMART repair areas
- This spray primer has very good build compared to other aerosol primer products
- Fast drying and easy to sand, the product can be overcoated with either solvent or water-based topcoats



Part No.	Description	Qty	Price
547044	White	1	£11.06
547046	Grey	1	£11.06
547048	Black	1	£11.06
547050	Green	1	£11.06
547052	Blue	1	£11.06
547054	Red	1	£11.06



5 min TOUCH DRY IN

PROXL SYSTEM Acrylic Top Coat

- High quality Acrylic finish
- Excellent durability and UV resistance
- Very fast drying
- Good opacity

500ml Acrylic Topcoats

- Outstanding industrial colours for durability
- Gives an excellent UV resistant finish that provides good gloss levels and opacity
- Drying times are fast allowing quicker handling of articles
- Can be applied directly to metal substrates and has anti-corrosive properties

- High-quality Acrylic finish
- Excellent durability and UV resistance
- Very fast drying
- Good opacity
- Available in over 40 RAL colours with the addition of Agricultural and Industrial colours, as well as Safety and Pipeline colours

Safety Colours

Part No.	RAL Colour	Use	Qty	Price
547534	1007 Daffodil Yellow	Take Care/Warning	6	£71.70
547540	1018 Zinc Yellow	Danger	6	£71.70
547554	3000 Flame Red	Stop/Forbidden	6	£71.70
547566	5005 Signal Blue	Safe Space/Escape Routes	6	£71.70
547570	5012 Light Blue	Fresh Water	6	£71.70

Pipeline Colours

Part No.	RAL Colour	Use	Qty	Price
547532	1004 Golden Yellow	Gas	6	£71.70
547560	4001 Red Lilac	Acid	6	£71.70
547570	5012 Light Blue	Air	6	£71.70
547576	6010 Grass Green	Water	6	£71.70
547596	8001 Ochre Brown	Liquid Spirits	6	£71.70
547602	9005 Pure Black	Other Liquids	6	£71.70
547604	9006 Aluminium Silver	Steam	6	£71.70

Industrial Colours

Part No.	RAL Colour	Qty	Price
547530	1003 Signal Yellow	6	£71.70
547532	1004 Golden Yellow	6	£71.70
547534	1007 Daffodil Yellow	6	£71.70
547536	1013 Oyster White	6	£71.70
547538	1015 Light Ivory	6	£71.70
547540	1018 Zinc Yellow	6	£71.70
547542	1021 Rape Yellow	6	£71.70
547544	1023 Traffic Yellow	6	£71.70
547546	1028 Melon Yellow	6	£71.70
547548	2000 Yellow Orange	6	£71.70
547550	2002 Vermilion	6	£71.70
547552	2003 Pastel Orange	6	£71.70
547554	3000 Flame Red	6	£71.70
547556	3001 Signal Red	6	£71.70

Part No.	RAL Colour	Qty	Price
547558	3020 Traffic Red	6	£71.70
547560	4001 Red Lilac	6	£71.70
547562	5002 Ultramarine Blue	6	£71.70
547564	5003 Sapphire Blue	6	£71.70
547566	5005 Signal Blue	6	£71.70
547568	5010 Gentian Blue	6	£71.70
547570	5012 Light Blue	6	£71.70
547572	6001 Emerald Green	6	£71.70
547574	6005 Moss Green	6	£71.70
547576	6010 Grass Green	6	£71.70
547578	6011 Reseda Green	6	£71.70
547579	6018 Yellow Green	6	£71.70
547580	6032 Signal Green	6	£71.70
547582	7001 Silver Grey	6	£71.70

Part No.	RAL Colour	Qty	Price
547584	7005 Mouse Grey	6	£71.70
547586	7015 Slate Grey	6	£71.70
547588	7016 Anthracite Grey	6	£71.70
547590	7021 Grey Black	6	£71.70
547592	7032 Pebble Grey	6	£71.70
547594	7035 Light Grey	6	£71.70
547596	8001 Ochre Brown	6	£71.70
547598	8002 Signal Brown	6	£71.70
547600	9001 Cream	6	£71.70
547602	9005 Pure Black	6	£71.70
547606	9006 Silver White	6	£71.70
547608	9010 Pure White	6	£71.70

Agricultural Colours

Part No.	Colour	Qty	Price
547610	Amazone Green	6	£71.70
547612	Amazone Orange	6	£71.70
547614	Bobcat Grey	6	£71.70
547616	Bobcat Orange	6	£71.70
547618	Bobcat White	6	£71.70
547620	Case Int Black	6	£71.70
547622	Case Int Harvester Red	6	£71.70
547624	Case Power Red	6	£71.70
547626	Case Power Tan	6	£71.70
547628	Case Int Red	6	£71.70
547630	Caterpillar Yellow	6	£71.70
547632	Claas Green	6	£71.70
547634	Claas Red	6	£71.70
547636	Deutz Green	6	£71.70
547638	Doosan Orange	6	£71.70

Part No.	Colour	Qty	Price
547640	Fendt Green	6	£71.70
547642	Fendt Grey	6	£71.70
547644	Ford Tractor Blue	6	£71.70
547646	Ford Empire Blue	6	£71.70
547648	Hitachi Orange	6	£71.70
547650	Hitachi ZX Dark Grey	6	£71.70
547652	Hitachi ZX Cab Grey	6	£71.70
547654	JCB New Yellow	6	£71.70
547656	JCB Yellow	6	£71.70
547658	John Deere Yellow	6	£71.70
547660	John Deere Green	6	£71.70
547662	Kobelco Aqua	6	£71.70
547664	Komatsu Grey	6	£71.70
547666	Komatsu Yellow	6	£71.70
547668	Kubota Charcoal Blue	6	£71.70

Part No.	Colour	Qty	Price
547670	Kubota Orange	6	£71.70
547672	Manitou Red	6	£71.70
547674	MF Light Grey	6	£71.70
547676	MF Silver Mist	6	£71.70
547678	MF Super Red	6	£71.70
547680	MF Industrial Yellow	6	£71.70
547682	McHale Green	6	£71.70
547684	MF Stoneleigh Grey	6	£71.70
547686	New Holland Yellow	6	£71.70
547688	Post Office Red	6	£71.70
547690	Terex Grey	6	£71.70
547692	Terex White	6	£71.70
547694	Toyota Orange	6	£71.70
547696	Volvo Grey	6	£71.70
547698	Volvo Yellow	6	£71.70

Line Marking Paints



- 750ml aerosol
- Can be used manual or with line marking applicator

Part No.	Description	Qty	Price
699960	Blue	1	£5.19
699963	Red	1	£5.19
700000	Yellow	1	£5.19
700002	White	1	£5.19

3mm Ambersil Acrylic Paint Markers



- Excellent opaque coverage, even on dark surfaces
- Fast drying & long-lasting
- Durable tip with valve action to prevent excess paint flow
- Easy, accurate application

Part No.	Description	Qty	Price
VANAMB130	White	1	£5.49
VANAMB131	Yellow	1	£5.49

5L Standard Cellulose Thinners

- A versatile solvent designed to work with a variety of cellulose based paints and products



£14.99

Part No. 610220

Quality Pure Bristle Paint Brushes



- All purpose brush for paint & varnish
- Made with pure black bristle & SRT for improved performance

Part No.	Description	Qty	Price
810336	½"	1	£0.95
810338	1"	1	£2.08
810339	1½"	1	£2.29
810340	2"	1	£2.71
810342	3"	1	£5.15
810343	4"	1	£8.02

250ml Brush Mate Solution



£20.79

Part No. 923553

1/2-3" General Purpose Paint Brush Assortment

- Pack of 10



£11.15

Part No. 540238

Economy Pure Bristle Paint Brushes



- Single usage brushes ideal for applying glue, resins & throwaway applications

Part No.	Description	Qty	Price
810354	½"	12	£5.15
810344	1"	12	£6.00
810327	1½"	12	£7.02
810341	2"	12	£9.68
810346	3"	12	£17.63
810349	4"	1	£1.84

White Spirit



- Thins solvent paints and varnish
- For brushes, rollers and pads
- Suitable for thinning oil-based paints, cleaning paintbrushes and cleaning up paint spills
- Not suitable for use with acrylic or water-based paints

Part No.	Description	Qty	Price
910236	2L	1	£7.95
912298	4L	1	£18.05

Windsor Pure Bristle Paint Brushes



- A traditional painter's 100% pure black natural bristle brush
- Treble boiled and double combed for straightness
- Bristle "breaks-in" and improves over time to achieve outstanding trade performance
- Stainless steel ferrule

Part No.	Description	Qty	Price
810570	1"	1	£7.65
810572	1½"	1	£9.38
810574	2"	1	£19.78
810576	3"	1	£29.24

Paint Roller Kits



- Emulsion roller & tray sets
- For use on smooth & semi-smooth surfaces
- 9" set includes: 1 emulsion roller head, tray and roller handle
- 4" set includes: 1 gloss & 1 emulsion roller head, tray & roller handle

Part No.	Description	Qty	Price
810500	9" Set	1	£5.42
810518	4" Set	1	£3.19

9" Plastic Paint Tray



£4.50

Part No. 810507

Sash Brushes



Part No.	Size	Qty	Price
990236	No8 - ½"	1	£3.39
990238	No12 - ¾"	1	£4.08
990242	No20 - 1¼"	1	£8.11

4" Plastic Paint Tray



£2.18

Part No. 9-54710

4" Paint Roller Head (Foam) - Pack of 10



£9.35

Part No. B057358

4" Paint Roller Handle



£1.98

Part No. 810511

Touch-Up Brushes



Part No.	Size	Qty	Price
914757	No 4	1	£0.96
934139	No 2	1	£0.98

9" 1½" Core Paint Roller Handle



£5.12

Part No. 810503

9" 1¾" Core Solvent Foam Paint Roller Head



£17.23

Part No. 810502

9" 1½" Core Emulsion Roller Head



£1.39

Part No. 818132

2.5L Paint Kettle



£1.97

Part No. 810457

2300ml Polypropylene Paint Mixing Cups



- Pack of 100

£90.20

Part No. 610184

400ml Paint Mixing Cups



- Pack of 200

£79.02

Part No. 610182

280 micron Mesh Paint Strainers

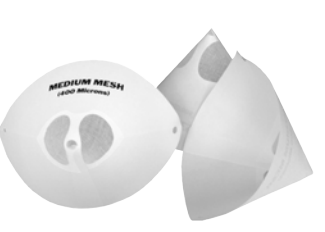

- Pack of 10

£4.31

Part No. 610181

4m x 150m Overspray Masking Film on Roll



- Protects from overspray
- High quality translucent film
- Easy application
- Holds closely to body contours

£36.76

Part No. 656150

50m 80° Masking Tape



- For protecting body trim & mouldings during painting & spraying
- Ideal for fixing masking paper
- Temperature resistance: -30 to +100°C
- Long term temperature resistance: 80°C

Part No.	Description	Qty	Price
B299966-9	25mm	9	£14.22
B299968-6	50mm	6	£17.94

180m Masking Paper



- For covering surfaces or panels before painting

Part No.	Size	Qty	Price
656313	18"	1	£14.66
656312	36"	1	£24.05
656314	48"	1	£42.25

U-Pol High Performance Tack Cloths



- High performance synthetic cloth
- Excellent pick-up power and trapping of particles
- Provides perfect surface with no marks or smears
- Pack of 10

£4.94

Part No. 610175

5L Pre-Wipe Degreaser

- Reduces the risk of silicone contamination and can be used for thorough cleaning prior to polishing



£28.74

Part No. 510299

U-Pol Onion Board Multi-Layered Mixing Palette



- For mixing filler pastes and materials
- Coated paper avoids soaking up resins and solvents
- Simply tear off and discard used sheet

Part No.	Description	Qty	Price
610361	Single	1	£12.01
610350	Multipack	10	£114.09

U-Pol Applicators for Body Filler



- Pack of 20

£7.61

Part No. 610270

2L Fibrofill No9 Glass Fibre Resin



- Ideal for bridging and filling holes in metal and glass fibres surfaces
- A tough body filler reinforced with glass fibre to give a solid and vibration resistant repair

£26.42

Part No. 610230

1L Polyester Resin



- A multipurpose resin with controllable setting time for mouldings, fabricating and repairs steel, alloy

£15.64

Part No. 610689

5L Laminating Resin

- A multipurpose resin with controllable setting time for mouldings, fabricating and repairs steel, alloy



£55.83

Part No. 610688

1kg Andronox Hardener (suits 610688)



£30.86

Part No. 610208

1m² Bodyline Glass Fibre Matting



- For the bridging of large holes in vehicle bodywork
- To be used in conjunction with Tetrosyl Polyester Resin

£8.04

Part No. 610680

500ml FASTGLAS Glass Fibre Kit



- This ISOPON FASTGLAS Repair Kit contains everything you need to make a permanent, glass fibre reinforced repair to all kinds of objects
- Repairs are tough, lightweight, weatherproof and permanent
- Can be used with metal, wood, brick, stone and ceramics
- Simply wet the glass fibre mat with activated resin to form a tough glass fibre reinforced plastic
- This bonds to most materials and dries in 20-30 minutes permanently retaining its shape
- Fast and easy to use with simple instruction guide in the kit for a quick and easy repair
- Repairs an area of 0.5m²

£19.24

Part No. 910268

U-Pol P40 Glass Fibre Repair Paste



- Two component chemical paste used for the bridging of holes in surfaces such as steel and GRP
- Forms a very hard durable surface and can be sanded and shaped if required
- It is easily covered with standard polyester filler or can be over-painted directly

Part No.	Size	Qty	Price
910266	600ml	1	£26.88
610262	1.85L	1	£37.47

U-Pol B Glass Fibre Bridging Compound



- Polyester glass fibre filler is a two component chemical paste used for the bridging of holes and rust in surfaces such as steel and GRP
- Forms a very hard durable surface and can be sanded and shaped if required. It is easily covered with standard polyester filler or can be over-painted directly

Part No.	Size	Qty	Price
610243	1L	1	£23.96
610900	1.85L	1	£32.68

750ml U-Pol TOP STOP Smooth Finishing Stopper



- Can be used on the following surfaces: Bare metal e.g. Steel Aluminium and Zinc coated substrates, original paint surfaces & GRP

£25.69

Part No. 610263

Fillers



Two component chemical paste used for the filling of holes and imperfections in surfaces such as steel and GRP



Easy to use ultra smooth finishing filler for skimming and fine finishing in thin layers prior to the paint process

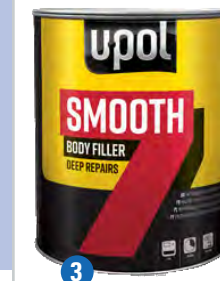

Ideal for repairing large, deep or uneven areas. The formula is specially developed to give excellent filling properties whilst maintaining smooth spreading capabilities and good adhesion



Specially formulated for the professional user and combines good filling and smooth spreading properties together with ease of sanding

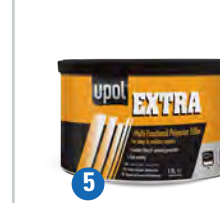

Two component multifunctional paste used for the filling of holes and imperfections in most substrates

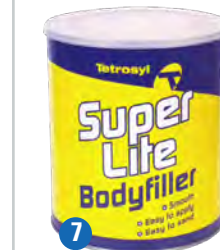

An all purpose lightweight body filler suitable for application to numerous substrates

For use with polyester body filler

Part No.	Description	Qty	Price
1	510276 3L EASY 1 Super Easy Sanding Lightweight Filler	1	£32.59
2	610265 1.1L EASY 3 Extra Smooth Finishing Filler	1	£38.36
3	510274 3L Smooth 7 Body Filler	1	£33.87
4	610253 2.25L P38 Body Repair Paste	1	£29.21
5	610229 1.1L EXTRA - Smooth Body Filler	1	£22.46
6	610228 2.1L EXTRA - Smooth Body Filler	1	£30.27
7	610226 7kg Super Lite Body Filler c/w Hardener	1	£26.36
8	610227 40g Tube Hardener	1	£3.14

Underbody Coating

- Permanent coating of vehicle under bodies & fenders
- Protects the underside of the bodywork against corrosion
- Resistant to moisture & road salt



Part No.	Description	Qty	Price
B689645	500ml Black	1	£5.72
B371683	1L Black	1	£7.76
B408524	1L Water Based Grey	1	£10.48
B408523	1L Water Based Black	1	£10.48

Black Stone Chip Protection

- Permanent coating of vehicle under bodies, fenders & sills
- Resistant to water & road salt
- Synthetic resin
- Good adhesion, no drips & no processing spray mist
- Recommended processing temperature approximately 20°C



Part No.	Description	Qty	Price
B689653	500ml Black	1	£6.46
B911699	1L Black	1	£8.69

Air Operated Underbody Coating Gun

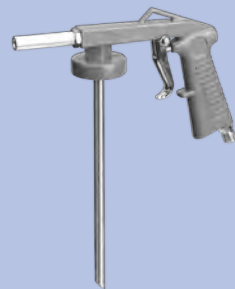

- Air Consumption: 10cfm
- Air Inlet Size: 1/4" BSP
- Recommended Air Pressure: 90psi

£19.95

Part No. SG139

Rust Removers



Part No.	Description	Qty	Price
1	B368217 400ml MoS ₂ Rust Remover	1	£5.09
2	B408450 400ml Rust Remover Graphite	1	£6.59
3	B408447 400ml Rust Remover Ice PREMIUM with Smart Straw	1	£7.46

PU Sealers and Seam Sealers – see page 37

5pc Trim Clip Removal Set



- For quick and easy disassembly of door lining, blind stops, protective caps, decorative frames, frameworks, etc

£23.14

Part No. B053623

3pc Trim Removal Wedge Set



£21.66

Part No. BT004381

255mm Trim and Panel Removal Tool



£10.18

Part No. B341499

22 x 270mm Trim and Panel Removal Tool



£5.09

Part No. B147312

750ml One Component PU Foam

- Uses include for creating acoustic seals, sealing and insulating cooling systems, installing door and window frames, filling cavities & sealing openings in roof structures
- Can be used at temperatures between +5 and +30°C
- Can be cut after: 30 minutes

£7.18

Part No. B372432



Part No.	Description	Qty	Price
1	BT031652 Fir Tree Fixing for General Use	50	£10.58
2	BT031570 Fir Tree Fixing for Ford/General Use	50	£11.60
3	BT031680 Fir Tree Fixing for VW/General Use	50	£19.38
4	BT031614 Fir Tree Fixing for Ford/General Use	50	£16.76
5	BT035054 Fir Tree Fixing for Renault	50	£12.73
6	BT031571 Fir Tree Fixing for General Use	50	£7.48
7	BT031586 Fir Tree Fixing for VW/General Use	50	£11.92
8	BT031694 Drive Rivet for VW/General Use	50	£18.12
9	BT036191 Drive Rivet for Volvo, Land Rover/General Use	50	£20.44
10	BT031649 Push Rivet Retainer for General Use	50	£20.08
11	BT031623 Push Rivet Retainer for BMW	50	£26.80
12	BT036058 Push Rivet Retainer for Toyota, Lexus, General Use	50	£11.08

Part No.	Description	Qty	Price
13	BT031621 Push Rivet Retainer for Mazda/General Use	50	£26.18
14	BT035037 Push Rivet Screw for BMW, Mini, General Use	50	£22.87
15	BT036116 Push Rivet Retainer for Mercedes/General Use	50	£10.48
16	BT031651 Screw Rivet Retainer for Mazda/ General Use	50	£21.80
17	BT036119 Screw Rivet for Mercedes, Land Rover/General Use	50	£17.33
18	BT031588 Screw Rivet for Mazda, Chrysler, General Use	50	£22.23
19	BT031620 Trim Rivet Plastic for BMW/General Use	50	£26.09
20	BT031592 Panel Clip for Mazda, Toyota, General Use	50	£8.47
21	BT031629 Panel Clip for Honda, Subaru, Toyota, General Use	50	£14.31
22	BT031660 Panel Clip for BMW, VW, General Use	50	£14.42
23	BT031582 Trim Locking Nut for Toyota/General Use	50	£23.83

340pc Fir Tree Fixings



- Manufactured in nylon
- Original manufacturer replacement trim clip suitable for Ford, GM, Mazda, Nissan, Audi, VW or general automotive use

£59.90

Part No. BT036037

350pc Popular Drive Push Pin Rivets

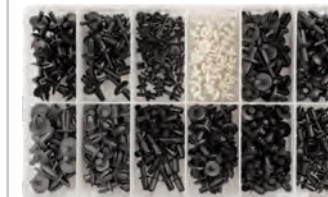

- Manufactured in nylon
- Original manufacturer replacement trim clip suitable for Ford, GM, Mazda, Nissan, Audi, VW or general automotive use
- For general application on many vehicles and popular motorbikes

£68.56

Part No. BT036041

240pc Screw Rivet Trim Fixings



- Manufactured in nylon
- Original manufacturer replacement trim clips suitable for general automotive use on many vehicles and popular motorbikes

£59.33

Part No. BT036044

235pc Plastic Rivets



- Manufactured in nylon
- Original manufacturer replacement trim clips suitable for Ford, GM, Mazda, Nissan, Audi, VW or general automotive use

£81.70

Part No. BT036038

2.5m x 100mm Curtain Repair Tape

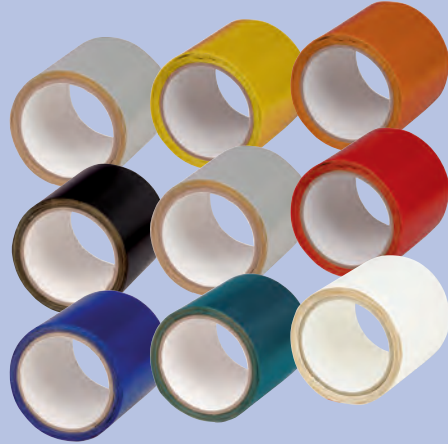

- For repairing damaged or cut tarpaulins
- Simple, fast and durable repair of tarpaulins
- Extremely practical for on the go repairs
- Self-adhesive: no tools required

Part No.	Description	Qty	Price
B214824	White Aluminium	1	£42.38
B214826	Yellow	1	£42.38
B214827	Orange	1	£42.38
B120470	Black	1	£42.38
B120471	Grey	1	£42.38
B120472	Red	1	£42.38
B120473	Blue	1	£42.38
B120474	Green	1	£42.38
B120475	White	1	£42.38

Conspicuity Tape

- Highlights contours of trucks exceeding 7.5 tonnes and trailer exceeding 3.5 tonnes
- Increased resistance to solvents and high pressure washing

Curtain Grade

Part No.	Description	Qty	Price
B156822	12.5m x 50mm Red	1	£38.06
B156821	50m x 50mm White	1	£126.90
B156820	50m x 50mm Yellow	1	£126.90

Rigid Grade

Part No.	Description	Qty	Price
B156815	12.5m x 50mm Red	1	£54.60
B156814	50m x 50mm White	1	£126.90
B156813	50m x 50mm Yellow	1	£126.90



100mm x 10m Flash Band Lead Finish



- Pack of 6
- This bitumen based self-adhesive aluminium tape has a lead appearance for gutter and roofing repairs
- Once applied to cleaned surfaces
- Very durable - can last years

£64.90

Part No. 656300

25 x 1.1mm x 33m UHB Foam Tape White

- Bonds well to a wide range of metals, plastics, ceramics and composites
- Grey impregnated foamed acrylic tape presented on a red PE filmic liner



£57.41

Part No. 656466

19 x 3mm x 25m Double Sided Foam Tape

- Designed for general purpose medium weight bonding and fixing
- PE foam coated with solvent acrylic adhesive

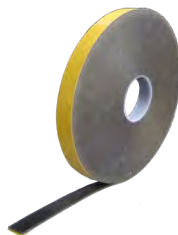

£17.72

Part No. 656277

Double Sided Tape



- Designed for applying to body side mouldings & emblems

Part No.	Description	Qty	Price
656269	12mm x 10m	1	£3.21
656283	19mm x 10m	1	£4.16
656271	25mm x 10m	1	£5.92
656273	50mm x 10m	1	£11.39

10/3 Black Compriband Expanding Foam Tape



- Soft and flexible open cell polyurethane foam, impregnated with an acrylic based, UV stabilised resin
- The resin is water repellent and contains a fire retardant
- Weather tight against the most severe combinations of wind and rain
- Full BBA approval, the product has been extensively tested and has a proven reputation (Cert. 96/3309)

£15.16

Part No. 656527

50m 80° Masking Tape

- For protecting body trim & mouldings during painting & spraying
- Ideal for fixing masking paper
- Temperature resistance: -30 to +100°C
- Long term temperature resistance: 80°C



Part No.	Description	Qty	Price
B299966-9	25mm	9	£14.22
B013741-6	38mm	6	£16.37
B299968-6	50mm	6	£17.94

Anti-Slip Adhesive Tape

- Used on low foot traffic areas with slippery ground surfaces such as corridor, workshops, warehouses, slopes, stairs, tread board and machines

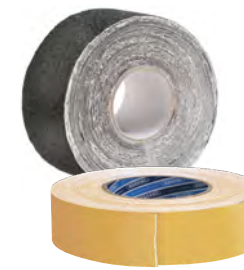

Part No.	Description	Qty	Price
656511	Yellow 50mm x 18.3m	1	£29.96
656529	Black 50mm x 18m	1	£32.10

50mm x 10m Denso Tape

- Seals against the effects of weathering and protects against water, chemicals, etc
- Use on pipes, valves, joints and cables above and below ground



£4.85

Part No. 656500

Gaffer Tank Tape

- Based on waterproof backing with a high grab adhesive
- They can be used in interior and exterior conditions



Part No.	Description	Qty	Price
656268	50mm x 50m Silver	2	£9.23
656297	50mm x 50m Red	1	£5.65

Permacell Upholstery Tape

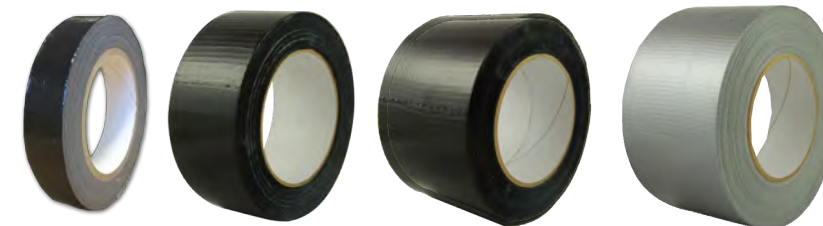

- Economy grade polyethylene laminated cloth coated with a pressure sensitive adhesive
- Designed as a general purpose cloth tape for a full range of industrial and construction applications such as sealing, protection, insulating, repairs and bundling

Part No.	Description	Qty	Price
656258	1" x 50m - Black	1	£5.04
656262	2" x 50m - Black	1	£5.27
656266	3" x 50m - Black	1	£5.50
656265	3" x 50m Heavy Duty - Silver	1	£12.90

80° Fine Line Masking Tape

- For applications where a sharp edge is needed
- Can be used to mask around locks, for example. The tape is ideal for this because it will easily follow the contours of the lock without creasing
- It is also used in custom painting where the very sharp edge allows two-tone paint finishes to be created

Part No.	Description	Qty	Price
656291	3mm x 55m	1	£5.90
656289	6mm x 55m	1	£4.65
B108068	12mm x 55m (Bernier)	1	£2.85
656292	12mm x 55m	1	£6.93
656292M	12mm x 55m (3M)	1	£17.59
656294	19mm x 55m	1	£10.56
656293	25mm x 55m	1	£13.90



Self-Amalgamating Black Butyl Tape



- For sealing of pipes, electrical conduits
- Self-curing
- Resistant to water and chemicals
- Weatherproof
- Butyl rubber

Part No.	Description	Qty	Price
B152962	19mm x 10m Self-Amalgamating Black Butyl Tape	1	£7.91
FORB14195	50mm x 5m Self-Amalgamating Tape Black	1	£15.47

38mm x 33m PVC Duct Tape Grey/Silver

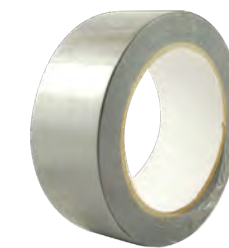

£3.88

Part No. 646290

19mm x 6mm Foam Draught Excluder 15m



£23.08

Part No. 732340

PVC Insulation Tape



*Assortment contents: 2 x white, blue, red, green and yellow

Part No.	Description	Qty	Price
B49600	15mm x 10m Black	10	£5.38
646214	19mm x 20m Black	10	£7.03
646216	50mm x 33m Black	3	£13.94
605594	19mm x 20m Grey	10	£7.03
646238	19mm x 20m White	10	£7.03
646222	19mm x 20m Red	10	£7.03
646234	19mm x 20m Blue	10	£7.03
646226	19mm x 20m Yellow	10	£7.03
646230	19mm x 20m Green	10	£7.03
646242	19mm x 20m Green/Yellow	10	£7.03
646218	19mm x 20m Brown	10	£7.03
646244	19mm x 20m Assortment*	10	£11.20

12mm x 12m PTFE Thread Sealing Tape



- Pack of 10
- Thread sealing tape certified to EN751-3 and WRAS approved

£3.63

Part No. 656254

50mm x 33m Adhesive Hazard Tape Black/Yellow

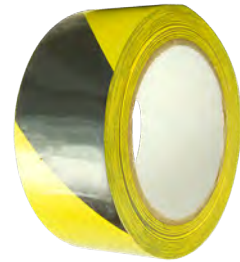

£4.51

Part No. 656475

50mm x 33m Adhesive Hazard Tape Red/White

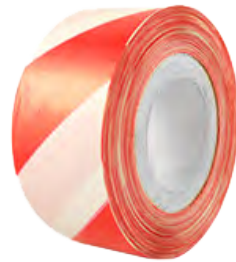

£4.51

Part No. 656476

19mm x 25m Black Cable Fabric Band Tape



£4.26

Part No. B149838

Professional Barrier Tape



Part No.	Description	Qty	Price
656482	75mm x 500m Black/Yellow	1	£6.05
656480	75mm x 500m Tape Red/White	1	£6.05



48mm x 66m Stationary Tape Clear



£1.19

Part No. 656326

50mm x 50m HD Acrylic Parcel Tape

- Pack of 3



£4.10

Part No. 646256

Parcel Tape Dispenser Gun Large Core

- Tape sold separately



£8.48

Part No. 656253

2500kg Standard Pallet Truck



- Capacity: 2500kg
- Minimum Fork Height: 85mm
- Maximum Fork Height: 200mm
- Size of Fork: 160mm X 60mm
- Overall Fork Width: 550mm
- Fork Length: 1150mm

- Provides the user with minimal stress to move pallets within the workplace from A to B in a quick safe manner
- The Tandem Load Rollers which help spread the load on the floor surface and thus reduces ground contact loading by 50% making it easier to move heavier loads on the pallet truck resulting in less effort / strain for the operator
- Suitable for EURO, CHEP and UK sized pallets
- The channel reinforced frame ensures fork alignment is not compromised, and with a top quality German hydraulic pump with a slow lowering hand control, 3 position lever
- Fitted with German hydraulic seals
- 2 nylon entry and exit rollers prevent physical exertion of the operator and protect load rollers and pallet
- Full 12 months parts and labour warranty
- Please note that colour can vary between red or yellow depending on current stock holding

£365

Part No. 900680

250kg Capacity Heavy-Duty Sack Truck with PU Tyres



- Heavy-duty tubular steel construction with welded joints with 250kg capacity
- Fitted with solid polyurethane (PU) tyres so you never have to worry about punctures or inflating
- Resistant to most oils, grease and many common chemicals
- Fitted with knuckle protecting D-shaped handle grips
- 3 Year guarantee

£109.95

Part No. CST986HD

150kg Capacity Sack Truck with Solid Tyres



- Strong tubular steel construction with welded joints
- Fitted with heavy-duty solid rubber wheels and cannot be punctured by sharp objects
- Resistant to most oils, grease and many common chemicals, perfect for work on building site
- Can be rested on handles for flat loading
- Fitted with rubber handgrips

£69.95

Part No. CST983

Platform Truck with Removable Sides Pneumatic Tyres 200kg Capacity



- Heavy-duty steel with hinged mesh construction
- Cushioned grip pull handle with smooth steering action for easy manoeuvrability
- Steel centred pneumatic wheels allow transport over the toughest terrain
- Drop-down sides, for easy loading, are also removable, allowing use as a flatbed for oversized items
- Suitable for a variety of warehouse, office, garden and domestic hauling applications

£199.95

Part No. CST997

M22 x 1.5 Right Hand Disc-Lock Wheel Nut



£11.81

Part No. 590514

1.25mm Locking Wire Heavy Galvanised Steel 0.5kg Coil



£12.19

Part No. 710229

12in" Perforated Strips



£15.17

Part No. 540241

CV Boot Clamps Large Diameter 50-110mm



- Stainless Steel
- Pack of 20

£17.98

Part No. VANHCV2

O Clips

- Zinc plated
- Used to crimp over the ends of hoses to secure hose tails



Part No.	Size	Qty	Price
546284	1/2 (11-13mm) O Clips	50	£8.01
546260	9/16 (13-15mm) O Clips	50	£8.50
546288	5/8 (15-18mm) O Clips	50	£11.13
546290	3/4 (17-20mm) O Clips	25	£7.79

O Clip Pliers (Front Closing)



£20.42

Part No. 546298

Lifting Belts

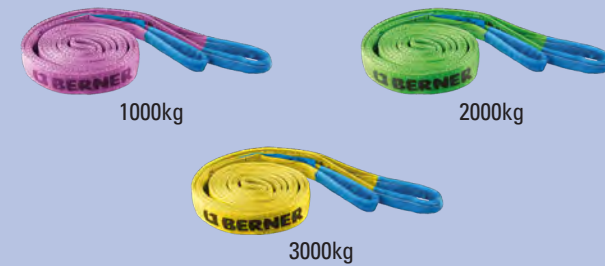

Part No.	Description	Qty	Price
B371280	2m 1000kg Lifting Belt Purple	1	£4.86
B371281	3m 1000kg Lifting Belt Purple	1	£6.86
B371282	4m 1000kg Lifting Belt Purple	1	£7.69
B371283	2m 2000kg Lifting Belt Green	1	£9.16
B371284	3m 2000kg Lifting Belt Green	1	£12.98
B371285	4m 2000kg Lifting Belt Green	1	£16.72
B371286	6m 2000kg Lifting Belt Green	1	£24.27
B371287	3m 3000kg Lifting Belt Yellow	1	£19.35
B371288	4m 3000kg Lifting Belt Yellow	1	£24.89
B371289	6m 3000kg Lifting Belt Yellow	1	£35.87

Round Lifting Slings



Part No.	Description	Qty	Price
B371263	2m 1000kg Round Sling Purple	1	£7.17
B371264	4m 1000kg Round Sling Purple	1	£9.91
B371265	6m 1000kg Round Sling Purple	1	£10.79
B371266	8m 1000kg Round Sling Purple	1	£11.89
B371267	2m 2000kg Round Sling Green	1	£11.10
B371268	3m 2000kg Round Sling Green	1	£16.53
B371269	4m 2000kg Round Sling Green	1	£18.65
B371270	6m 2000kg Round Sling Green	1	£20.41
B371271	8m 2000kg Round Sling Green	1	£22.91
B371272	4m 3000kg Round Sling Yellow	1	£16.97
B371273	6m 3000kg Round Sling Yellow	1	£23.99
B371274	8m 3000kg Round Sling Yellow	1	£28.60
B371275	12m 3000kg Round Sling Yellow	1	£47.21
B371276	8m 4000kg Round Sling Grey	1	£39.96
B371277	10m 4000kg Round Sling Grey	1	£50.13
B371278	8m 5000kg Round Sling Red	1	£48.71

1500kg 5m x 50mm Ratchet Lashing Belt for Anchor Rail 2pc



£14.95

Part No. B371261

Lashing Belt



Part No.	Description	Qty	Price
B371179	250kg 1m x 25mm	1	£1.93
B371196	250kg 2m x 25mm	1	£2.26
B371247	250kg 3m x 25mm	1	£2.54
B371745	250kg 4m x 25mm	1	£3.97

10000kg 4m x 75mm Heavy Duty Ratchet Lashing Belt with Double Pointed Hook 2pc

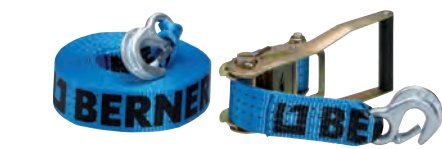

£64.59

Part No. B371262

1000kg 6m x 25mm Ratchet Lashing Belt with Snap Hook 2pc



£9.65

Part No. B371251

Claw Ratchet Straps



- For heavy industrial use
- Ideal for securing vehicle loads, marquees, shelter construction etc
- 50mm wide polyester webbing, with claw hook at each end
- Confirmed to EN12195-2

Part No.	Size	Qty	Price
307225	4T 10m	1	£13.72
307226	5T 10m	1	£16.35

Ratchet Lashing Belt



Part No.	Description	Qty	Price
B371249	500kg 4m x 25mm	1	£3.97
B371252	2000kg 6m x 35mm	1	£8.67
B371748	5000kg 8m x 50mm	1	£15.57

Ratchet Lashing Belt with Double Pointed Hook 2pc



Part No.	Description	Qty	Price
B371250	1000kg 6m x 25mm	1	£6.29
B371253	2000kg 6m x 35mm	1	£10.92
B371254	2000kg 8m x 35mm	1	£12.29
B371256	3200kg 12.5m x 50mm	1	£26.87
B371746	5000kg 8m x 50mm	1	£24.20

5000kg 8m x 50mm Long Lever Ratchet Lashing Belt with Double Pointed Hook 2pc



£30.51

Part No. B371750

Ratchet Lashing Belt with Snap Hook 2pc



Part No.	Description	Qty	Price
B184455	4000kg 8m x 50mm	1	£20.90
B184456	5000kg 8m x 50mm	1	£19.78

Ratchet Lashing Belt with Claw Hook 2pc



Part No.	Description	Qty	Price
B371255	2000kg 6m x 35mm	1	£12.52
B371751	4000kg 8m x 50mm	1	£21.10
B371258	4000kg 12m x 50mm	1	£26.74
B371257	5000kg 9m x 50mm	1	£22.00

Lashing Belt Loose End with Double Pointed Hook



Part No.	Description	Qty	Price
B184451	4000kg 7.5m x 50mm	1	£9.39
B184452	5000kg 7.5m x 50mm	1	£11.47

THE ORIGINAL LOOSE WHEEL NUT INDICATOR

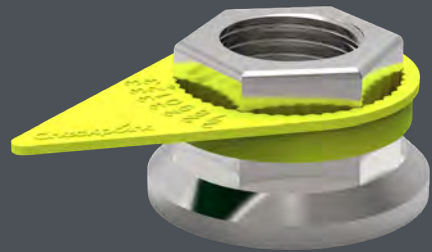

- Consistent melting temperature: 125°C to indicate overheating of the wheel
- UV additive to ensure stability and long life: tested to ISO 11507
- Available in a range of sizes: 13-50mm
- Available in a range of colours:



Wheel Nut Indicators

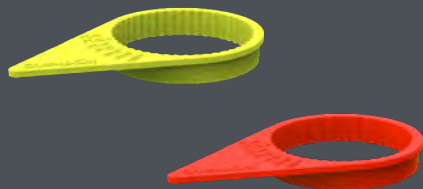

- To cover a wide scope of applications throughout industrial, agricultural, military, rail & commercial vehicle sectors amongst others
- Improved safety of fittings where nuts are a critical structural component
- Instant visual indicator of nut movement
- Reduction in maintenance costs resulting from accurate locating of nut loosening or wheel overheating
- Reduction in vehicle downtime
- Cost effective & easy solution to implement

Yellow

Part No.	Size	Colour	Qty	Price
430312	17mm	Yellow	100	£37.13
430309	19mm	Yellow	100	£37.13
430438	21mm	Yellow	100	£37.13
430313	24mm	Yellow	100	£37.13
430307	27mm	Yellow	100	£37.13
430311	30mm	Yellow	100	£37.13
430303	32mm	Yellow	100	£37.13
430305	33mm	Yellow	100	£37.13
430319	38mm	Yellow	100	£37.13
430321	40mm	Yellow	100	£37.13

Red

Part No.	Size	Colour	Qty	Price
430420	19mm	Red	100	£37.13
430324	21mm	Red	100	£37.13
430428	27mm	Red	100	£37.13
430432	30mm	Red	100	£37.13
430436	32mm	Red	100	£37.13
430440	33mm	Red	100	£37.13

Dustite Wheel Nut Indicators

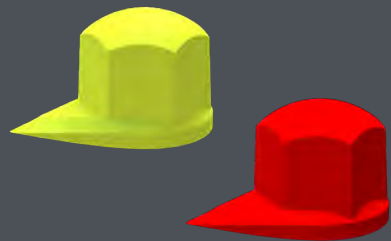

- An instant indicator of nut movement
- For commercial vehicles such as trucks, agricultural vehicles, dangerous goods transporters, etc
- Melts at a specific temperature to highlight problems with brakes overheating or any bearing defects
- Protection from weather, corrosion and general wear and tear
- Cost effective and easy to implement

Yellow

Part No.	Size	Colour	Qty	Price
430697	27mm	Yellow	50	£45.54
430699	30mm	Yellow	50	£45.54
430700	32mm	Yellow	50	£45.54
430702	33mm	Yellow	50	£45.54

Red

Part No.	Size	Colour	Qty	Price
430718	27mm	Red	50	£45.54
430719	30mm	Red	50	£45.54
430720	32mm	Red	50	£45.54
430722	33mm	Red	50	£45.54

Long Dustite Wheel Nut Indicators

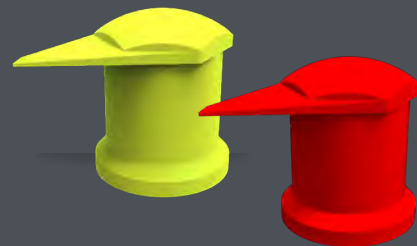

- Indicates nuts loosening on a wheel or when a wheel is overheating
- Specific for wheels with trims and step rings
- For light commercial vehicles
- Melts at a specific temperature to highlight problems with brakes overheating or any bearing defects
- Protection from weather, corrosion and general wear and tear
- Cost effective and easy to implement

Yellow

Part No.	Size	Colour	Qty	Price
430715	19mm	Yellow	50	£47.11
430714	21mm	Yellow	50	£47.11
430716	24mm	Yellow	50	£47.11
430693	27mm	Yellow	50	£47.11
430695	30mm	Yellow	50	£47.11
430696	32mm	Yellow	50	£47.11
430698	33mm	Yellow	50	£47.11

Red

Part No.	Size	Colour	Qty	Price
430730	19mm	Red	50	£47.11
430732	21mm	Red	50	£47.11
430734	24mm	Red	50	£47.11
430723	27mm	Red	50	£47.11
430724	30mm	Red	50	£47.11
430725	32mm	Red	50	£47.11
430726	33mm	Red	50	£47.11

BUS, TRUCK & TRAILER



Mueller Kueps Press & Pull Sleeve Kit (Car / LCV)

- A universal system for the removal and installation of Suspension Bushes, Bearings, Seals etc
- By selecting the appropriate diameter sleeves, the bush / bearing / seal is 'Pressed', or 'Pulled' by the action of turning the spindle nuts in opposing directions
- Fully universal applications for Cars, LCV's HGV's etc, with a range of kit options to suit individual requirements
- All components are available individually as spare parts

£438.90

Part No. 800800



Part No.	Description	Qty	Price
1	800802 Universal C-Clamp	1	£261.87
2	800804 Multi Thread Spindle - Short	1	£124.60



Steering Wheel Covers

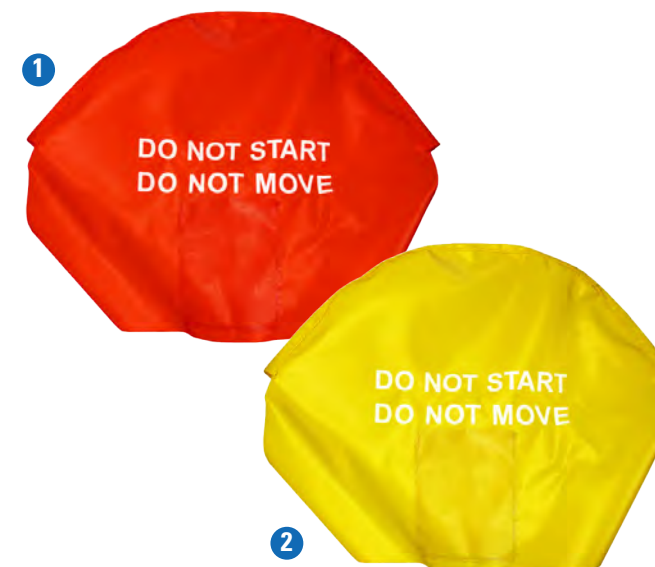

- Easy to slip on and secure to steering wheels to prohibit use
- For use with coaches, buses and vehicle fleets

Part No.	Colour	Qty	Price
1	960570 Red	1	£25.91
2	960572 Yellow	1	£25.91

Red Steering Wheel Disc VOR



- Dia. 30cm
- Adjustable hook and eye velcro strap
- Rigid foam board

£11.86

Part No. 960576



Anti-Slip Mat 5m x 250mm

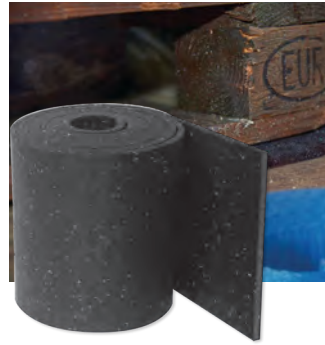

- Creates a non-slip surface
- Faster loading because fewer lashing straps are required
- Reusable premium product

£29.14

Part No. B399476

10mm x 220m Polypropylene Rope



£41.93

Part No. 610266

20" High Road Marking Cone



£6.44

Part No. 711532

VTG6A Lightweight MOT Holder



- For VTG6A Certificate size
- Dimensions: 178 x 178mm

£6.13

Part No. 422226

Cover Nets for Containers



- Approved - Complies with VDI 2700 sheet 3.3
- Durable quality
- Knotted design with edge warping
- Optimum security
- 200 daN mesh breaking load and 74kg knot strength

Part No.	Size	Qty	Price
B371290	2.5 x 3.5m	1	£26.00
B371291	2.5 x 4m	1	£29.61
B371292	5 x 3.5m	1	£46.27
B371293	7 x 3.5m	1	£73.19

Ball Joint Separator



- Strong, heavy duty body, with strengthened fork and lever, allows for greater force to be applied

£117.56

Part No. 816442

Small Emergency GHE Window Hammer



- Red polypropylene with a steel core
- Hardened steel tips
- Suitable for 5mm safety glass

£6.28

Part No. 296104

28" Collapsible Pro Cone with LED Light



- Pull up traffic cone that can be deployed and packed away in seconds
- Ideal for emergencies and breakdowns
- Includes integrated LED light

£30.80

Part No. 996812

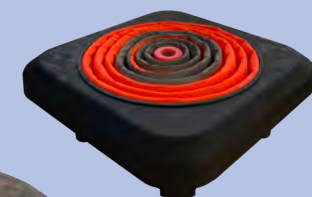

HGV Wheel Stud Service Kit



- HGV wheel stud service kit, designed for fast and effective removal and installation of wheel studs on most disc and drum applications
- For use on inboard hubs on HGV trucks and buses (disc or drum brakes)
- Kit includes interchangeable adapters for maximum access flexibility
- Removal of the hub is not required, which removes the risk of damage to hubs, seals, wheel bearings & wheel studs
- Recommended for use with an air-powered impact wrench/gun

£527.96

Part No. BT008125

Impact Drive Stud & Hub Cleaning Tool For HGV



- A complete hub & stud cleaning tool set for HGV wheel hubs
- Designed to fit on an air, corded or cordless impact wrench with 1/2" D connection
- Includes: Impact Drive locking sleeve, disc tightening and loosening adaptor and 6 abrasive discs
- To fit over most HGV wheel studs up to 28mm in diameter to a maximum of 80mm long

£116.72

Part No. BT007640

85 x 22mm Universal Budget lock



£2.92

Part No. 732318

125mm Budget Tee Key



£2.67

Part No. 732308

HGV Hub Puller Kit



- Universal wheel HUB extractor
- Variable for pitch circle diameter up to 445mm
- To suit wheel stud sizes commonly found on DAF, MAN, MERC, RENAULT, SCANIA & VOLVO models
- Contains 5 x thread adaptor pairs;
 - - M18 x P1.5 x 65mm/L
 - - M20 x P1.5 x 65mm/L
 - - M22 x P1.5 x 65mm/L
 - - 7/8" - 11 BSF
 - - 7/8" - 14 UNF

£580.93

Part No. 816450

10 x 6" Solid Rubber Wheel Chock



£54.75

Part No. 485020

235mm x 205mm Solid Rubber Wheel Chock - Single

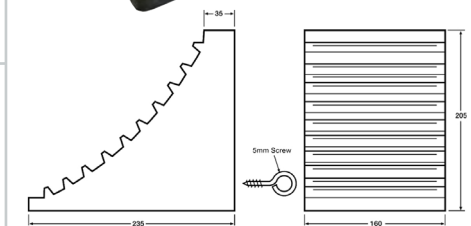

- Material: Natural / SBR rubber compound
- Weight: 5.2Kg
- Qty: 1
- Complies with recommended DVSA specification for authorised testing facilities

£60.46

Part No. 485026

Silicone Hose - 1m Lengths



Part No.	Description	Qty	Price
400106	6mm	1	£13.73
400107	8mm	1	£10.81
400108	10mm	1	£14.19
400110	13mm	1	£17.39
400114	16mm	1	£19.25
400118	19mm	1	£20.83
400122	22mm	1	£22.89
400126	25mm	1	£23.58
400130	28mm	1	£26.54
400134	32mm	1	£30.69
400136	35mm	1	£32.04
400138	38mm	1	£32.98
400140	42mm	1	£34.33
400142	45mm	1	£36.37
400144	48mm	1	£36.87
400146	50mm	1	£39.22
400147	54mm	1	£42.16
400148	57mm	1	£44.11
400250	60mm	1	£45.56
400254	63mm	1	£48.02
400266	89mm	1	£81.71

Silicone Elbows - 4" Legs



Part No.	Description	Qty	Price
400150	13mm (1/2")	1	£14.92
400151	16mm (5/8")	1	£14.92
400154	19mm (3/4")	1	£14.92
400290	25mm (1")	1	£15.74
400292	32mm (1 1/4")	1	£16.50
400160	38mm (1 1/2")	1	£17.92
400296	45mm (1 3/4")	1	£20.28
400298	50mm (2")	1	£22.74

Silicone Elbows - 6" Legs



Part No.	Description	Qty	Price
400145	10mm (3/8")	1	£16.54
400152	16mm (5/8")	1	£17.58
400155	19mm (3/4")	1	£17.58
400156	22mm (7/8")	1	£17.58
400158	25mm (1")	1	£18.45
400159	28mm (1 1/8")	1	£18.63
400161	32mm (1 1/4")	1	£19.23
400293	35mm (1 3/8")	1	£19.84
400321	45mm (1 3/4")	1	£23.58
400345	50mm (2")	1	£26.54
400143	61mm (2.13/32")	1	£27.68

Silicone Elbows - 8" Legs



Part No.	Description	Qty	Price
400336	25mm (1")	1	£20.31
400340	38mm (1 1/2")	1	£23.01

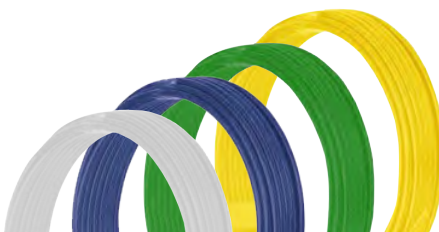

Tubing also available in Natural, Blue, Green & Yellow at unitedindustrial.co.uk

15m Black Nylon Tubing

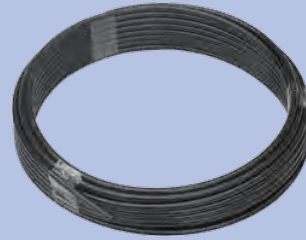

Part No.	Description	Qty	Price
TG1211	4mm OD x 2mm ID	1	£9.36
TG1221	6mm OD x 4mm ID	1	£13.09
TG1231	8mm OD x 6mm ID	1	£17.47
TG1241	10mm OD x 8mm ID	1	£23.72
TG1251	12mm OD x 9mm ID	1	£37.43

30m Black Nylon Tubing

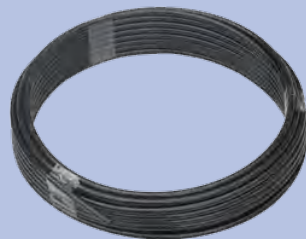

Part No.	Description	Qty	Price
TG1311	4mm OD x 2mm ID	1	£18.71
TG1321	6mm OD x 4mm ID	1	£26.19
TG1331	8mm OD x 6mm ID	1	£34.94
TG1341	10mm OD x 8mm ID	1	£35.99
TG1351	12mm OD x 9mm ID	1	£74.86

30m Red Nylon Tubing



Part No.	Description	Qty	Price
765002	4mm OD x 2.5mm ID	1	£17.49
765006	6mm OD x 4mm ID	1	£27.06
765010	8mm OD x 6mm ID	1	£46.70
765014	10mm OD x 8mm ID	1	£57.39
765018	12mm OD x 9mm ID	1	£79.86

Speedfit Nylon Straights



Part No.	Description	Qty	Price
730212	4mm	10	£13.31
730214	5mm	10	£12.94
730216	6mm	10	£13.18
730218	8mm	10	£13.55
730222	10mm	10	£17.78
730224	12mm	10	£19.27
730225	15mm	10	£21.54

Speedfit Nylon Reducing Straight Connectors



Part No.	Description	Qty	Price
730330	6-4mm	10	£16.90
730332	8-6mm	10	£18.60
730334	10-8mm	10	£17.99
730336	12-10mm	10	£27.30

50pc Speedfit Nylon Straight Coupling Assortment



• Contents: 10x 4mm, 10x 5mm, 10x 6mm, 10x 8mm, 5x 10mm & 5x 12mm straight couplings

£98.71

Part No. 750799

Speedfit Nylon Elbows



Part No.	Description	Qty	Price
730296	4mm	10	£14.41
730298	6mm	10	£16.15
730301	8mm	10	£17.13
730302	10mm	10	£20.98
730304	12mm	10	£31.27

Speedfit Nylon Push Fit Reducers



Part No.	Description	Qty	Price
730338	5-4mm	10	£10.65
730340	8-6mm	10	£12.35
730342	10-8mm	10	£14.26
730344	12-10mm	10	£25.66

24pc Speedfit Nylon Straight Couplings Assortment



• Contents: 4x 4mm, 6x 6mm, 6x 8mm, 4x 10mm & 4x 12mm straight couplings

£40.18

Part No. 542204

Speedfit Nylon T Pieces



Part No.	Description	Qty	Price
730265	4mm	10	£17.08
730267	5mm	10	£18.65
730268	6mm	10	£23.20
730270	8mm	10	£23.17
730272	10mm	10	£26.49
730274	12mm	10	£27.38
730276	15mm	5	£28.07

Speedfit Plugs



Part No.	Description	Qty	Price
730346	For Stem OD 4mm	10	£4.85
730348	For Stem OD 6mm	10	£5.07
730350	For Stem OD 8mm	10	£5.15
730352	For Stem OD 10mm	10	£12.31
730354	For Stem OD 12mm	10	£14.39

17pc 6-12mm Speedfit Couplings, Elbows & Tees Assortment



Contents:
• 4 x Tees: 6, 8, 10, 12mm
• 4 x Elbows: 6, 8, 10, 12mm

£39.28

Part No. 543104

Truck Repair Maxi Stor Kit



- Bulkhead Locknut
- Straight Studs
- Elbow Swivels
- Tee Swivel Centres
- Tee Swivel Sides
- Tee Swivel Onrun
- Straight Swivels
- Bulkhead O Rings
- F Fitting Swivel
- Plugs

£291.83

Part No. 366076

Tube Support



Part No.	Description	Qty	Price
TG3151	4mm	10	£2.40
TG5152	6mm	1	£0.85
TG3152	6mm	10	£2.65
TG5153	7mm	1	£0.40
TG3160	7.5mm	10	£3.22
TG5154	8mm	1	£0.18
TG3154	8mm	10	£2.33
TG5155	9mm	1	£0.14
TG5158	12mm	1	£0.30
TG5159	14mm	1	£0.36

4mm Push In Straight Equal Connector



- Pack of 10

£41.56

Part No. 366013

Bulkhead M22-M16 Female with Locknut



£6.12

Part No. TG4499

Straight Connectors



Part No.	Description	Qty	Price
B799289-5	6mm	5	£18.71
B032652-5	8mm	5	£19.50
B014953-5	9mm	5	£33.10
B032653-5	10mm	5	£23.23
B799106-5	12mm	5	£31.74
B033172-5	16mm	5	£76.11

Elbow Studs



Part No.	Description	Qty	Price
TG6602	M12 - 6mm OD	1	£11.65
TG6605	M16 - 8mm OD	1	£16.01
TG6613	M16 - 10mm OD	1	£14.97
TG6619	M16 - 12mm OD	1	£16.77

Stud Connectors



Part No.	Description	Qty	Price
TG4505	6 x 1 - M16 x 1.5mm	1	£4.14
TG4508	8 x 1 - M12 x 1.5mm	1	£4.14
TG4529	12 x 1.5 - M16 x 1.5mm	1	£9.58
TG4520	10 x 1.25 - M22 x 1.5mm	1	£8.01

M16 1.5mm - 12mm Straight Stud Connector



- Pack of 5

£50.72

Part No. B032659-5

1/4 BSP to 4mm Straight Stud



£3.75

Part No. TG2831

Push In Straight Equal Connectors



Part No.	Description	Qty	Price
653131	6mm	10	£23.97
653154	10mm	10	£27.62
TG4416	12mm	1	£3.63
TG4419	16mm	1	£11.24

Taper Swivel Elbows



Part No.	Description	Qty	Price
TG4462	1/8 BSP x 6mm OD	1	£3.38
TG4469	1/8 BSP x 8mm OD	1	£5.31

16mm Elbow



£9.93

Part No. TG4478

M18 x 1.5mm 4m Compact Coils



Part No.	Description	Qty	Price
TG2127	Yellow Tail	1	£25.81
TG2128	Red Tail	1	£25.81

Self Sealing Palm Couplings



Part No.	Description	Qty	Price
800500	M16 x 1.5 Yellow	1	£22.35
800502	M16 x 1.5 Red	1	£22.35

Operating Palm Couplings



Part No.	Description	Qty	Price
800504	M22 x 1.5 Yellow	1	£10.92
800506	M22 x 1.5 Red	1	£10.92

VOS 232 Male Nuts



Part No.	Description	Qty	Price
TG4759	M16 x 1.5 NG8	1	£3.99
TG4760	M22 x 1.5 NG12	1	£4.31

M22 x 1.5 Plug



£1.14

Part No. TG7623

M18 x 1.5 Coil End Adaptor



£1.20

Part No. TG2023

1/2 BSP Male C Coupling



£2.86

Part No. 134210

Blanking Plugs with O-Ring



Part No.	Description	Qty	Price
TG4717	M12 x 1.5mm	1	£1.49
TG4715	M16 x 1.5mm	1	£2.02
TG4716	M22 x 1.5mm	1	£2.98

Brass Equal Ended Couplings



Part No.	Description	Qty	Price
722254	6mm	20	£26.63
722256	8mm	10	£15.64
722258	10mm	10	£19.13
722260	12mm	10	£23.75
722264	16mm	5	£37.98

M12 - 10mm Straight Stud



£6.64

Part No. TG6577

M22 x 1.5 - 15 x 1.5mm Straight Stud





£12.60

Part No. TGRA720

Raufoss™ Quick coupling system for polyamide pipes in the compressed COUPLINGS

Components of the ABC™ System

Small	Regular	Heavy Duty
 <p>Tube dimensions: 6 x 1 mm 8 x 1 mm</p>	 <p>Tube dimensions: 6 x 1 – 12 x 1.5 mm</p>	 <p>Tube dimensions: 12 x 1.5mm 15 x 1.5mm 16 x 2mm</p>

Advantages compared to standard systems

- European system for trucks, trailers and buses
- Very simple push-in installation with quick couplings
- Two-step installation with built-in safety
- Acoustic assembly control (acoustic signal in case of leakage)
- Weight reduction of up to 83% by using plastic instead of brass parts
- Only 2 parts needed to make an assembly
- Flexible application options
- Reusable by simple disassembly

101pc ABC Brake Fittings Assortment



- ABC Quick Couplings
- Threadless adaptor
- Tube Release Tools
- Reducers
- Elbows
- Swivel Studs
- Male Studs
- ABC Rotolocks
- Blind Stops

£432.59
Part No. B136970

37pc Raufoss Comp Maxi Stor Kit



- Tee Coupling Body
- Threadless Test Point
- Integral Elbows
- Elbow Body
- Swivel Studs
- Threadless Couplings
- Tube Release Tools

£184.83
Part No. 810680

Male Stud Couplings

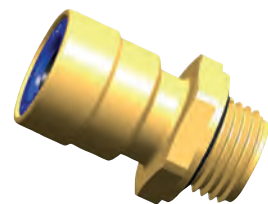

Part No.	Description	Tube	Qty	Price
B339227-5	10 x 1mm	6 x 1mm	5	£19.36
B136738-5	12 x 1.5mm	6 x 1mm	5	£23.06
B339226-5	10 x 1mm	8 x 1mm	5	£26.85
B136861-5	12 x 1.5mm	8 x 1mm	5	£17.79
B339225-5	14 x 1.5mm	8 x 1mm	5	£31.55
B136862-5	16 x 1.5mm	8 x 1mm	5	£18.92
B136864-5	12 x 1.5mm	10 x 1mm	5	£34.78
B339224-5	14 x 1.5mm	10 x 1mm	5	£49.51
B136865-5	16 x 1.5mm	10 x 1mm	5	£27.23

Part No.	Description	Tube	Qty	Price
B339223-5	12 x 1.5mm	10 x 1.25mm	5	£32.15
B339222-5	16 x 1.5mm	10 x 1.25mm	5	£28.09
B339221-5	12 x 1.5mm	10 x 1.5mm	5	£36.17
B339220-5	16 x 1.5mm	10 x 1.5mm	5	£25.07
B136868-5	12 x 1.5mm	12 x 1.5mm	5	£28.45
B136869-5	16 x 1.5mm	12 x 1.5mm	5	£20.93
B339219-5	16 x 1.5mm	15 x 1.5mm	5	£30.78
B136871-5	16 x 1.5mm	16 x 2mm	5	£31.00
B136872-5	22 x 1.5mm	16 x 2mm	5	£35.93

Male Stud Couplings



Part No.	Description	Tube	Qty	Price
B362816-5	14 x 1.5mm	6 x 1mm	5	£32.15
B136860-5	16 x 1.5mm	6 x 1mm	5	£21.09
B339218-5	22 x 1.5mm	6 x 1mm	5	£35.72
B136863-5	22 x 1.5mm	8 x 1mm	5	£25.54
B136866-5	22 x 1.5mm	10 x 1mm	5	£39.68
B339217-5	22 x 1.5mm	10 x 1.25mm	5	£37.43
B362817-5	22 x 1.5mm	10 x 1.5mm	5	£39.59
B136870-5	22 x 1.5mm	12 x 1.5mm	5	£29.01
B339216-5	22 x 1.5mm	15 x 1.5mm	5	£33.70

Male Swivel Stud Couplings

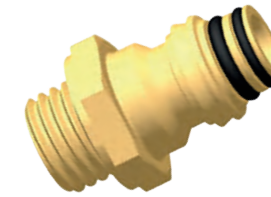

Part No.	Description	Type	Rotolock	Qty	Price
B362839-5	10 x 1mm	Small		5	£16.97
B362840-5	12 x 1.5mm	Small		5	£16.25
B362841-5	14 x 1.5mm	Small		5	£36.51
B362842-5	16 x 1.5mm	Small		5	£16.96
B362844-5	10 x 1mm	Regular	B136956-5	5	£16.53
B136873-5	12 x 1.5mm	Regular	B136956-5	5	£13.42
B136874-5	14 x 1.5mm	Regular	B362868-5	5	£17.69
B136876-5	16 x 1.5mm	Regular	B136957-5	5	£16.96
B136877-5	22 x 1.5mm	Regular	B136958-5	5	£19.47
B136878-5	16 x 1.5mm	Heavy Duty	B136959-5	5	£25.06
B136879-5	22 x 1.5mm	Heavy Duty	B136960-5	5	£27.06
B362850-5	26 x 1.5mm	Heavy Duty		5	£119.63

Male Swivel Bulkhead Couplings

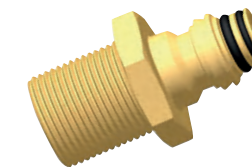

Part No.	Description	Rotolock	Qty	Price
B362851-5	18 x 1.5mm - 12 x 1.5mm	B136957-5	5	£95.11
B136880-5	22 x 1.5mm - 16 x 1.5mm	B136958-5	5	£35.28
B362855-2	28 x 1.5mm - 22 x 1.5mm		2	£34.47

Male Swivel Bulkhead Couplings with Push In

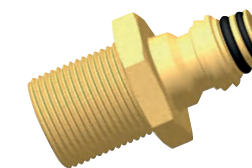

Part No.	Description	Tube	Rotolock	Qty	Price
B362857-5	20 x 1.5mm	8 x 1mm		5	£41.76
B362858-5	24 x 1.5mm	12 x 1.5mm	B136958-5	5	£48.41

Swivel Bulkhead Couplings with Cone

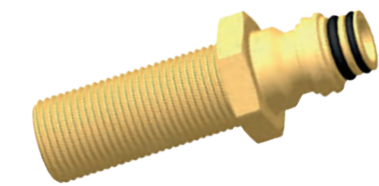

Part No.	Description	Angle	Type	Length	Rotolock	Qty	Price
B362853-5	16 x 1.5mm	24°-10	Regular	35mm	B136957-5	5	£83.80
B362854-5	18 x 1.5mm	24°-10	Regular	22mm	B136957-5	5	£107.32
B136881-5	18 x 1.5mm	24°-12	Regular	42mm		5	£40.36
B362856-2	18 x 1.5mm	24°-12	Heavy Duty	42mm		2	£36.07

Swivel Internal Threaded Couplings



Part No.	Description	Type	Rotolock	Qty	Price
B362845-5	10 x 1mm	Regular	B136956-5	5	£39.02
B332374-5	12 x 1.5mm	Regular	B136956-5	5	£32.46
B362846-5	14 x 1.5mm	Regular	B136956-5	5	£34.99
B332373-5	16 x 1.5mm	Regular	B136957-5	5	£39.09
B332371-5	22 x 1.5mm	Regular	B136958-5	5	£41.06

Swivel Couplings with Cone



Part No.	Description	Angle	Rotolock	Qty	Price
B362848-5	12 x 1.5mm	24°	B136956-5	5	£48.80

Male Swivel Stud Couplings



Part No.	Description	Type	Length	Qty	Price
B362843-5	16 x 1.5mm	Small	37mm	5	£79.02
B362847-5	14 x 1.5mm	Regular	42mm	5	£83.80
B362849-5	14 x 1.5mm	Regular	55mm	5	£102.22

Swivel Bulkhead Couplings

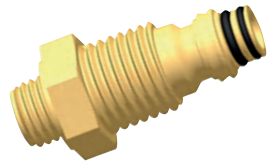

Part No.	Description	Qty	Price
B136882-5	16 x 1.5mm - 22 x 1.5mm	5	£53.48
B362852-5	22 x 1.5mm - 22 x 1.5mm	5	£51.65

Swivel Plug Couplings

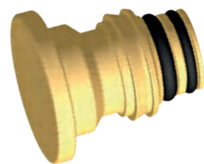

Part No.	Description	Qty	Price
B362865-5	Small	5	£22.42
B362866-5	Regular	5	£27.01
B362867-5	Heavy Duty	5	£34.34

Threadless Quick Couplings



Part No.	Description	Tube	Qty	Price
B362818-5	Small	6 x 1mm	5	£17.31
B362819-5	Small	8 x 1mm	5	£16.40
B136883-5	Regular	6 x 1mm	5	£18.28
B136884-5	Regular	8 x 1mm	5	£18.67
B136890-5	Regular	10 x 1mm	5	£26.44
B136891-5	Regular	10 x 1.25mm	5	£26.70
B362820-5	Regular	10 x 1.5mm	5	£26.44
B136897-5	Regular	12 x 1.5mm	5	£21.38
B136905-5	Heavy Duty	12 x 1.5mm	5	£21.87
B136913-5	Heavy Duty	15 x 1.5mm	5	£28.89
B136921-5	Heavy Duty	16 x 2mm	5	£30.56

Push-In Tube Couplings



Part No.	Description	Qty	Price
B332367-5	6 x 1mm	5	£28.14
B332366-5	8 x 1mm	5	£29.23
B332365-5	12 x 1.5mm	5	£41.92

Integral 90° Push-In Couplings



Part No.	Type	Tube	Qty	Price
B362821-5	Small	6 x 1mm	5	£26.13
B362822-5	Small	8 x 1mm	5	£36.66
B136930-5	Regular	6 x 1mm	5	£26.28
B136932-5	Regular	8 x 1mm	5	£31.71
B136939-5	Regular	10 x 1mm	5	£34.16
B136941-5	Regular	10 x 1.25mm	5	£34.28
B362823-5	Regular	10 x 1.5mm	5	£38.52
B136942-5	Regular	12 x 1.5mm	5	£40.22
B136944-5	Heavy Duty	15 x 1.5mm	5	£45.31
B136945-5	Heavy Duty	16 x 2mm	5	£47.73

Threadless Adaptors



Part No.	Description	Type	Qty	Price
B362859-5	39mm	Small	5	£20.77
B136955-5	45mm	Regular	5	£21.66

Connectors with Bracket



Part No.	Description	Type	Qty	Price
B362860-2	45mm	Regular	2	£13.55

T Type Couplings



Part No.	Description	Type	Qty	Price
B362824-5	53mm	Small	5	£17.46
B136950-5	62mm	Regular	5	£18.94
B136951-3	72mm	Heavy Duty	3	£13.63

T Type Couplings with Bracket



Part No.	Description	Type	Qty	Price
B362829-2	27mm	Regular	2	£12.35
B362834-2	28mm	Heavy Duty	2	£14.96

90° Elbows



Part No.	Description	Type	Qty	Price
B136947-5	29mm	Regular	5	£18.14
B136948-5	34mm	Heavy Duty	5	£17.96

45° Elbows



Part No.	Description	Type	Qty	Price
B362827-5	22mm	Small	5	£23.34
B136946-5	25mm	Regular	5	£25.37
B362835-2	30mm	Heavy Duty	2	£11.20

F Type Couplings



Part No.	Description	Type	Qty	Price
B362825-5	26.6mm	Small	5	£42.81
B136949-5	31mm	Regular	5	£36.66
B362833-2	36.3mm	Heavy Duty	2	£18.80

Y Type Couplings



Part No.	Description	Type	Qty	Price
B362826-5	46.9mm	Small	5	£29.07
B136952-5	54.8mm	Regular	5	£32.03

Male Union Connectors



3-Way Block Couplings



Part No.	Description	Type	Qty	Price
B362828-2	24mm	Small	2	£12.25
B362832-2	28mm	Regular	2	£12.06
B362836-2	33mm	Heavy Duty	2	£13.74

4-Way Block Connectors



Part No.	Description	Type	Qty	Price
B362831-2	29mm	Regular	2	£18.68
B362838-2	34mm	Heavy Duty	2	£21.02

4-Way Block Couplings



Part No.	Description	Type	Qty	Price
B362830-2	28mm	Regular	2	£13.93
B362837-2	33mm	Heavy Duty	2	£16.04

Reducer



Part No.	Description	Qty	Price
B136954-5	Heavy Duty > Regular	5	£19.57

Test Point



Part No.	Description	Qty	Price
B136953-5	Regular	5	£20.25

Rotolock



Part No.	Description	Type	Qty	Price
B136956-5	18mm	Regular	5	£4.66
B362868-5	20mm	Regular	5	£7.91
B136957-5	22mm	Regular	5	£4.92
B136958-5	28mm	Regular	5	£7.08
B136959-5	22mm	Heavy Duty	5	£10.97
B136960-5	28mm	Heavy Duty	5	£12.55

HGV Air Brake Test Gauge



Part No.	Description	Type	Qty	Price
B362869-5	Small	Small	5	£11.91
B362870-5	Small	Regular	5	£29.35
B362871-5	Regular	Regular	5	£35.09
B362872-5	Regular	Heavy Duty	5	£43.91
B362873-2	Heavy Duty	Heavy Duty	2	£18.91

£127.45

Part No. VS931

Push-In Plugs



Part No.	Description	Qty	Price
B362861-5	6 x 1mm	5	£3.50
B136967-5	8 x 1mm	5	£3.77
B362862-5	10 x 1/10 x 1.25/10 x 1.5mm	5	£3.87
B136968-5	12 x 1.5mm	5	£3.94
B362863-5	15 x 1.5mm	5	£10.36
B362864-5	16 x 2mm	5	£10.82

PA-Tubes



Part No.	Description	Length	Qty	Price
B028678	4 x 1mm	25m	1	£15.17
B111790	6 x 1mm	25m	1	£23.38
B111792	8 x 1mm	25m	1	£32.73
B111793	9 x 1.5mm	25m	1	£41.92
B111794	10 x 1mm	25m	1	£41.48
B111796	12 x 1.5mm	25m	1	£61.02
B111797	15 x 1.5mm	25m	1	£73.90
B142374	16 x 2mm	25m	1	£111.34

19-60mm Circlip Pliers External 90deg Curved Nose



- Straight jaws with non-slip precision tips
- PVC handle

£20.28

Part No. B001412

Tube Release Tools



Part No.	Description	Qty	Price
B136961-5	6 x 1mm	5	£14.10
B136962-5	8 x 1mm	5	£13.78
B136963-5	10 x 1/10 x 1.25/10 x 1.5mm	5	£17.47
B136964-5	12 x 1.5mm	5	£14.42
B136965-5	15 x 1.5mm	5	£17.96
B136966-5	16 x 2mm	5	£15.00

Professional Tube Release Tools



Part No.	Description	Qty	Price
B332370	6 x 1mm	1	£76.89
B332369	8 x 1mm	1	£77.32
B362735	10mm	1	£77.19
B332368	12 x 1.5mm	1	£76.18
B362814	15 x 1.5mm	1	£79.52
B362815	16 x 2mm	1	£89.46

255mm Hose Cutter



- For cutting Polyamide tubes
- Ø 4 t/m 28mm

Part No.	Description	Qty	Price
B113063	255mm Hose Cutter	1	£25.08
B145178	Replacement Blades	1	£10.30

Aluminium ABC Disassembly Tool



- For easy disconnection of PA lines from ABC coupling
- Short version for working in tight spaces
- Improved accessibility

Part No.	Description	Qty	Price
B411460	6 x 1mm	1	£78.85
B411461	8 x 1mm	1	£78.85
B411462	10 x 1mm	1	£78.85
B411463	12 x 1.5mm	1	£78.85
B411464	14 x 2mm	1	£78.85
B411465	15 x 1.5mm	1	£78.85
B411466	16 x 2mm	1	£78.85

Air Tubing Pipe Grips



- Designed to allow plastic air pipe to be gripped evenly and without damage to allow the pipes to be pushed into pipe fitting without kinking
- Sizes covered: 6, 8, 10, 12, 16mm
- Ideal for fitting pipes to pneumatic push fit style connectors found on HGV and LGV
- Adjustable self locking mechanism with release lever for use where access permits

£78.71

Part No. BT007030

12v 1.5BAR 1.25L Pressure Brake Bleeder with Multi Vehicle Cap Kit

Pressure brake bleeding is the only method approved by brake manufacturers

- The UK's top selling Brake bleeder
- Full fluid change in approx. 15 minutes by a single operator
- Portable: operates off 12V supply (vehicle battery)
- Fluid change capacity 1.25L
- Float switch to ensure pump stops when new fluid level is low
- No compressed air used, therefore no possibility of contamination of the fluid
- Supplied with ALB30564B multi vehicle cap adaptor kit
- Suitable for clutch bleed as well as brake bleed

£434.20

Part No. 200587

Available without cap kit for £412.20 - Part No. 200585



Combo Chassis Ear and Engine Ear



- Finds squeaks & rattles electronically – whilst vehicle is under load
- Improves workshop efficiency, revenues, customer satisfaction & saves time
- Listen to 6 under chassis locations at one time – all in one road test
- Hear noises that cannot be duplicated in the workshop
- Essential for saving needless warranty expense
- Supplied with headphones, control unit, noise wand & 6 pick-ups

£210.29

Part No. 910362

Heavy Duty Universal Flow Stop Kit

- A reusable system to keep fluids in and dirt & dust out of maintenance systems
- Ideal for use when flaring Brake Pipes
- Silicone free and highly resistant to many chemicals, acids and other aggressive fluids
- Dimensions: 1 - 42mm
- Temperature Range: -25°C to +90°C
- Ideal for brake system maintenance or injector replacement repair
- Includes: 4 x micro plugs (1-10mm), 4 x standard plugs (5-22mm), 2 x XL plugs (13-42mm)

£57.09

Part No. 910364



Brake Cleaner



- For cleaning and degreasing of brake and clutch systems
- Dries quickly and is residue free
- Does not damage varnishes, rubber or plastic
- Free from silicone, AOX, cadmium, acetone, hydrocarbons, chlorofluorocarbons, lead and aromatics
- Aerosol can be sprayed in different positions including upside down

Part No.	Description	Qty	Price	Part No.	Description	Qty	Price
371150	500ml	1	£1.98	B365882	5L	1	£14.72
371150-15	500ml	15	£28.99	B135128	1L Pump Sprayer	1	£22.11

200ml Ceramic Brake Service Paste

- For inspection and repair work of brake systems and screw connections exposed to high temperatures e.g. exhaust pipes, lambda sensors, turbines etc
- Excellent adhesive ceramic/aluminium lubricant with added pigments
- Suitable for ABS, ASR and ESP systems
- Protects against corrosion and oxidation
- Resistant to high pressure and high temperatures
- Free from heavy metals, silicones and acids



£14.97
Part No. B363619

DOT 4 Brake Fluid

- Suitable for all hydraulic brake & clutch systems with synthetic fluid
- Highly suitable for ABS brake systems
- Meets SAEJ 1703 (ISO 4925) FMVSS 116 DOT 4™
- Protects against corrosion (all metals)
- Can not be mixed with DOT 5.1



Part No.	Description	Qty	Price
B408528	1L	1	£5.50
B408526	5L	1	£23.20

5L Engine and Parts Cleaner

- Excellent degreasing and cleansing properties due to Alkaline solution and surface-active agents
- Protects against corrosion
- Economical as the product is highly concentrated
- Biodegradable
- Free of silicones, acids, AOX, NTA and EDTA



£19.00
Part No. B408487

12mm Steel Brake Caliper Wire Brush

- Plastic handle
- Hardened steel wire
- Length: 225mm



£9.20
Part No. 200581

Brake Springs

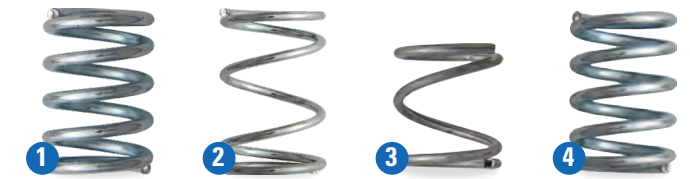

Part No.	Suits	Dimensions	Qty	Price	
1	VANBR71	Ford	14.5 x 16.5mm	100	£19.32
2	VANBR72	Vauxhall/GM	14 x 20mm	100	£16.08
3	VANBR73	Lockheed	18.5 x 20mm	100	£22.70
4	VANBR74	BL	14.5 x 22.5mm	100	£22.70

13pc Brake Service Kit



- Contents: 1/4" Dr impact bit Hex socket: 9 x 20mm, 3/8" Dr impact bit Hex sockets: 7, 8mm x 24mm; 9 x 50mm; 7 x 65mm; 7 x 92mm; 11 x 100mm, 3 double punches (3, 4.8, 5mm), caliper cleaning file and brush & Phillips PH3 impact screwdriver

£80.12
Part No. BT007919

3pc Twin Function Brake Pin Punch Set



- 3 double punches to assist in the removal of stuck brake pins
- Punch sizes: 3mm, 4.8mm, 5.5mm
- Concave ended short pin combined with full length extraction pin
- Chrome vanadium & plated for corrosion resistance

£26.40
Part No. BT007865

Male Brake Nuts

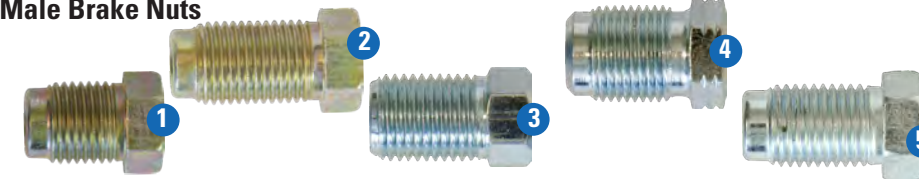

Part No.	Description	Qty	Price	Part No.	Description	Qty	Price		
1	VANBN11	M10 x 1mm Short	50	£8.02	4	VANBN17	M12 x 1mm Part Thread	50	£22.93
2	VANBN12	M10 x 1mm Long	50	£9.62	5	VANBN1	3/8 UNF x 24 TPI Long	50	£11.53
3	VANBN13	M10 x 1mm Full Thread	50	£8.14					

M10 x 1mm Short Female Brake Nuts

- Pack of 50
- For 3/16" pipe



£10.98
Part No. VANBN46

M10 x 1mm Female Brake Tubing Connectors

- Pack of 25
- Suits VANBN11



£20.60
Part No. VANBN66

Brake Shoe Hold Down Pins



Part No.	Description	Qty	Price	Part No.	Description	Qty	Price		
1	VANBR51	Ford L42mm	100	£20.75	3	VANBR53	GM L36mm	100	£20.75
2	VANBR52	Rover L42mm	100	£25.06					

Brake Shoe Hold Down Washers

Part No.	Description	Qty	Price	
1	VANBR61	8mm Lockheed	100	£14.33
2	VANBR62	6mm Girling	100	£17.11



3/16" OD x 25ft Copper Tubing BS2871



£13.90
Part No. 248620

2pc Hose Pinch Tool Set



- For clamping flexible pipes: plumbing, oil lines, compressed air lines & fuel lines
- Quick & simple, one handed use

£33.09
Part No. B208128

Brake Tubing 90/10 Cupro-Nickel 22 gauge

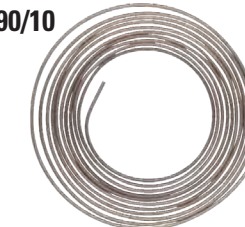

Part No.	Description	Qty	Price
448210	3/16" OD 25ft	1	£15.73
448212	1/4" OD 25ft	1	£40.58
448218	5/16" OD 25ft	1	£46.68
448222	3/8" OD 25ft	1	£57.54

Brake Pipe Flaring Kit - Turret Type



£239.95
Part No. PFT07

150pc Brake Nut Assortment

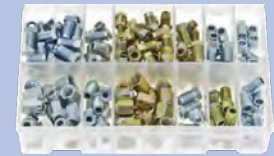

- For 3/16" pipe
Contents:
- 10 of each 3/8" UNF \varnothing x 24 TPI Male Brake Nuts (Short & Long)
 - 40 x M10 x 1mm Brake Nuts (Short)
 - 10 x M10 x 1mm Brake Nuts (Long)
 - 20 x M10 x 1mm Full Thread Brake Nut
 - 10 x M10 x 1mm Brake Tubing Connectors Female
 - 20 x M10 x 1mm Brake Nuts (Short)
 - 10 x 3/8" UNF x 24 TPI Female Brake Nuts (Long)
 - 20 x M12 x 1mm Part Threaded Brake Nut

£36.75
Part No. VANAB45N

40pc Accelerator & Clutch Springs



- Contents: 5 of each
53 x 12.4, 61.2 x 15.4, 63.4 x 13, 66 x 13.1, 77.4 x 23.15, 82.5 x 12.95, 84.2 x 10.9 & 86 x 13.3mm

£23.49
Part No. VANAB29

63pc Brake Pipe Fitting Assortment



- Contents
- 1 x Male Connector: 10 x 1.00mm
 - 2 x Female Connectors: 3/8" UNF x 24 TPI, 10 x 1.00mm
 - 2 x 3-way Connectors: 3/8" UNF x 24 TPI, 10 x 1.00mm
 - 5 x Brake Bleed Screws: 1/4" UNF x 28 TPI, 3/8" UNF x 24 TPI, M7 x 1.0mm, M8 x 1.25mm, M10 x 1.00mm

£66.92
Part No. 543087

PCL 21" Twin Hold-on Tyre Inflator

- Suitable for tyreshops, garages, car dealers and transport depots
- Built to withstand shock and meet the demands of high volume and intensive applications
- Robust and lightweight
- High performance dial gauge
- Features a user-friendly dial display for fast, trouble-free tyre inflation
- Meets industry standard EC86/217



£78.87

Part No. 520284

Digital Tyre Gauge

- 360° swivel head provides easier access to tyre valve
- Extra large digital display
- Measure in PSI, bar, KPA & kg/cm²



£16.87

Part No. VANAL71

930mm Tyre Lever



£83.17

Part No. 810580

PCL Airforce MK4 Tyre Inflator (0-138 psi / 0-9.6 bar)



- Gauge body weight: 923g, less work strain
- Reduced friction and no internal corrosion
- Calibration: 0-138psi/0-9.6bar
- Hose Length: 1.8m/6ft
- Accuracy Standards: meets EC 86/217 and compliant with EN12645:2014

£114.21

Part No. 520277

0.5-3.4 Bar Pocket Tyre Pressure Gauge



- Calibrated: 6 - 50 lbf/in² & 0.5 - 3.4 bar in 0.1 bar units

£9.89

Part No. VANAL45

VS0563 Digital Tyre Tread Depth Gauge



- DVSA approved
- Hardened and tempered stainless steel gauge
- Metric and imperial calibration with conversion between the two
- Zero reset control allows for comparative measurement

£54.62

Part No. 780867

PCL 0-174 psi Digital Tyre Pressure Gauge



- 4 measurement options - psi, bar, kPa & kg/cm²
- Clear large display
- Backlit screen for easy reading in dark or low light areas
- Calibration: 0-174 psi/0-12 bar/0-1200 kPa

£41.69

Part No. 520530

PCL Twin Open End Connectors



Part No.	Description	Qty	Price
520279	Hold-On 1/4" BSP	1	£10.85
520280	Clip-On 1/4" BSP	1	£37.49

PCL Twin Closed End Valve Connector



Part No.	Description	Qty	Price
570066	Hold-On	1	£13.65
570068	Clip-On	1	£43.99

PCL Heavy Duty Universal Service Gauge



£56.99

Part No. 520268

PCL Tyre Depth Gauge (MOT Approved)



- DVSA approved
- Provides accurate measurement of tread 1-26mm
- Features 1.6mm illegal tyre tread depth mark

£6.67

Part No. 520281

PCL Tyre Valve Tool

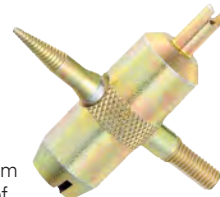

- Simple to use, versatile 4-in-1 tool:
1. Re-thread the external part of the tyre valve stem
 2. Re-thread the inside of the tyre valve stem
 3. Remove the tyre valve core
 4. Extract a damaged tyre valve core

£5.16

Part No. 520287

Vulcanising Fluid 175g Can



- For use with tube patches

£8.56

Part No. VANTY100

5kg Tyre Fitting Paste & Brush



- Used to lubricate the bead of the tyre during the mounting and dismounting process of vehicle tyres
- Creates a pressure resistant mounting film on the surface
- Reduces friction and wear caused by disassembly
- Added wax keeps rubber supple and prevents parts becoming brittle

Part No.	Description	Qty	Price
B337832	Black	1	£14.36
B337834	White	1	£14.36
B319236	Brush	1	£11.89

Tyre Repair Kit

- For all kinds of steel belted tyres
- Self-curing repair system
- Simple and quick
- Professional and permanent repair of tubeless tyres



£43.32

Part No. B160239

Combi Plug Patch



Part No.	Description	Qty	Price
173192	Up to 3.5mm	50	£40.38
173193	Up to 6mm	20	£35.56
173194	Up to 10mm	20	£84.89

Patch Stitch Roller



£6.95

Part No. 173191

Buffing Stone



£19.64

Part No. B173190

1L Liquid Buffer



£8.78

Part No. 231720

Valve Extension Holder



- For the attachment of a rubber valve extension on the outer rim

£3.82

Part No. B368824

OE Quality Zinc Wheel Weights

- For standard wheels

Part No.	Description	Qty	Price
426114	5g	100	£15.55
426115	10g	100	£18.49
426116	15g	100	£22.81
426117	20g	100	£38.85
426118	25g	100	£53.75



Part No.	Description	Qty	Price
426119	30g	100	£60.65
426120	35g	50	£34.16
426121	40g	50	£33.65
426122	45g	50	£28.78

OE Quality Wheel Weights for Alloy Wheels

Part No.	Description	Qty	Price
426131	10g	100	£14.10
426133	20g	100	£26.81



Adhesive Lead Free Wheel Weight Strips

Part No.	Description	Qty	Price
426000	60g Strip	25	£10.68
426010	60g Strip	100	£37.38



Wheel Weight Pliers

- For fixing, moving and loosening wheel balance weights



£18.59

Part No. B070009

Regrooving Blades

Part No.	Description	Qty	Price
426020	W Fix 2	20	£16.18
426030	W Fix 3	20	£16.18
426040	W Fix 4	20	£16.18
426050	W Fix 5	20	£16.18



Tyre Valve Extensions

- Commercial vehicle tyre valves
- To extend valves with dual tyre assembly

Part No.	Description	Qty	Price
B368825	100mm Flexible	10	£33.62
B368826-10	125mm Flexible	10	£34.05
B368827	134mm Flexible	10	£34.05
B368828	174mm Flexible	10	£36.85
B368829-10	210mm Flexible	10	£39.68
B368835	900mm Brass	10	£32.41
B368833-10	153mm Plastic	10	£28.36
B368834-10	170mm Plastic	10	£30.61
520288	Tyre Valve Caps	100	£5.42



Universal Yellow Marker Blocks - Pack of 12



- For use on metal, glass, rubber, etc
- Can be used on wet surfaces

£21.09

Part No. VANVC431

Yellow Tyre Marking Crayon Pack of 6



- Suitable for marking tyre damage or areas for repair
- Will work on practically any surface including rubber, metal and painted

£4.93

Part No. TST14

HB Marker Pencil Set



- For writing on wood, paper, cardboard, metal, glass, rubber, tyres, ceramic tiles & painted or synthetic surfaces
- Contents: 2x pencil holders & 15x spare pencils (5x graphite, 5x yellow & 5x red)
- Versatile - suitable for writing on a variety of dry & wet materials
- Practical - integrated sharpener in the cap

Part No.	Description	Qty	Price
B017343	HB Pencil Marker Set	1	£21.14
B023294	Replacement Lead Red	1	£3.38
B023295	Replacement Lead Yellow	1	£3.38
B023296	Replacement Lead Graphite	1	£3.38

500kg Capacity Adjustable Width Wheel Removal Trolley



- Suitable for changing wheels and tyres on large vehicles
- 8-Position adjustable roller width ranging from 440-780mm, giving greater flexibility
- Load arms incorporate smooth roller action sleeves allowing wheel to be rotated for lining up on studs
- Foot operated hydraulic mechanism with dead man's control release
- Mounted on two rear locking castors and two front castors for stability and easy manoeuvrability
- Supplied with safety chain
- This item is heavy, extra assistance must be provided at the delivery point to help its safe delivery

£949.95

Part No. W508T

1200kg Capacity Wheel Removal Trolley



- Eight adjustable rollers (four each side), allow for easy turning of large deep tread tyres
- Extra-large jacking handle and hydraulic foot pedal allow for one-person operation
- Safety bar with composite guard goes around wheel to ensure stability during transportation
- Locking mechanism allows rollers to be fixed at eight preset positions
- Mounted on two locking and two non-locking swivel castors for improved stability and easy manoeuvrability
- Ideal for use on agricultural and commercial wheels and tyres
- This item is heavy, extra assistance must be provided at the delivery point to help its safe delivery

£999.95

Part No. W1200T

Tyre & Wheel Handling Dolly 127kg Capacity



- Enables commercial sized wheels and tyres to be removed/installed on hub studs

£114.95

Part No. TH002

10tonne Capacity (per stand) Axle Stands



- Heavy-duty 10tonne axle stands to safely support vehicle for extended periods of time
- Heavy gauge steel frame and welded construction give superior strength and safety
- Large crutch for good load distribution
- Supplied with captive pin load support
- Suitable for commercial and public service vehicles
- Sold in pairs

£379.44

Part No. AS10

Wheel Dolly Set 454kg Capacity



- Two pressed steel wheel dollies
- Capacity: 454kg/dolly
- Ø90mm Metal castors
- Handles tyres up to 355mm profile
- Suitable for use in bodyshops, workshops and car parks

£124.57

Part No. WS454

10tonne Telescopic Low Entry Bottle Jack



- Fitted with overload valve
- Base and reservoir machine welded for increased strength and reduced chance of leakage
- Threaded pump assembly allows for easy disassembly and maintenance
- Supplied with 4-piece operating handle
- Service kits readily available

£127.45

Part No. BJ10LE

Heavy Duty Rubber Lined P-Clips



- Zinc Plated
- Ideal for fixing pipes & electrical cable to engine bays & chassis

Part No.	Description	Qty	Price
634600	12.70 x 10mm	10	£6.37
634601	14.25 x 10mm	10	£6.80
634602	15.75 x 10mm	10	£7.60
634603	16.75 x 10mm	10	£8.81
634604	17.75 x 10mm	10	£7.66
634605	19 x 10mm	10	£7.69
634606	21 x 10mm	10	£8.03
634607	23 x 10mm	10	£8.15
634608	24 x 10mm	10	£9.91
634609	27 x 10mm	10	£12.52
634610	30 x 10mm	10	£11.02
634612	33.30 x 12mm	10	£12.63
634613	34.80 x 12mm	10	£13.21
634614	38 x 12mm	10	£13.99
634615	39.40 x 12mm	10	£18.13
634616	40.65 x 12mm	10	£15.13
634617	42 x 12mm	10	£15.32
634618	44.50 x 12mm	10	£15.87
634620	50.80 x 12mm	10	£16.80
634621	53.90 x 12mm	10	£17.47
634622	57.20 x 12mm	10	£18.21
634623	63.50 x 12mm	10	£18.40
634624	70 x 12mm	10	£19.60
634628	90.50 x 12mm	10	£28.81

Rubber Lined P-Clips



- Zinc Plated
- Ideal for fixing pipes & electrical cable

Part No.	Description	Qty	Price
634274	6mm	50	£16.75
634276	8mm	50	£16.20
634278	10mm	50	£17.99
634280	13mm	50	£18.22
634404	14mm	25	£16.53
634282	16mm	50	£20.94
634283	19mm	50	£20.48
634284	21mm	25	£11.97
634406	22mm	25	£12.34
634408	25mm	25	£13.45
634285	25mm	50	£24.41
634410	28mm	25	£14.62
634286	29mm	25	£14.66
634414	32mm	25	£15.04
634288	35mm	25	£15.54
634290	38mm	10	£6.34
634291	40mm	10	£8.22
634292	42mm	10	£8.58
634294	48mm	10	£8.56
634416	50mm	25	£54.65
634295	52mm	10	£8.72
634296	54mm	10	£11.90
634298	60mm	10	£9.97
634301	64mm	10	£16.27

Hose Clips - Jubilee



- Zinc plated mild steel

Part No.	Description	Qty	Price
546400	Size 000 (No12) 9.5-12mm	25	£13.18
546402	Size M00 (No16) 11-16mm	25	£13.72
546404	Size 00 (No20) 13-20mm	25	£13.08
546406	Size 0 (No22) 16-22mm	25	£16.60
546408	Size 0X (No25) 18-25mm	25	£16.76
546410	Size 1A (No30) 22-30mm	25	£17.80
546412	Size 1 (No35) 25-35mm	25	£18.58
546414	Size 1X (No40) 30-40mm	25	£19.31
546460	Size 1m (No45) 32-45mm	25	£18.10
546456	Size 2A (No50) 35-50mm	10	£7.69
546454	Size 2 (No55) 40-55mm	10	£8.60
546450	Size 2X (No60) 45-60mm	25	£20.75
546452	Size 3 (No70) 55-70mm	25	£22.64
546458	Size 3X (No80) 60-80mm	10	£10.23
546426	Size 4 (No90) 70-90mm	10	£11.85
546428	Size 4X (No100) 80-100mm	10	£12.39
546433	Size 5 (No120) 90-120mm	10	£14.11
546442	Size 7 (No165) 135-165mm	10	£16.70

50pc 6-35mm BZP P Clips Rubber Lined Assortment



- 5 x Sizes: 6, 21, 29, 35 mm
- 10 x Sizes: 8, 10, 13, 16mm

£34.29

Part No. 540202

Hose Clips - Stainless Steel



- Ideal for salt water & other highly corrosive environments

Part No.	Description	Qty	Price
546152	Size 000 (No12) 9.5-12mm	10	£10.14
546154	Size M00 (No16) 11-16mm	10	£10.25
546156	Size 00 (No20) 13-20mm	10	£10.21
546158	Size 0 (No22) 14-22mm	10	£11.77
546160	Size 0X (No25) 17-25mm	10	£11.97
546162	Size 1A (No30) 22-30mm	10	£12.35
546164	Size 1 (No35) 25-35mm	10	£12.84
546166	Size 1X (No40) 30-40mm	10	£13.27
546168	Size 2A (No50) 35-50mm	10	£14.95
546170	Size 2 (No55) 40-55mm	10	£15.43
546172	Size 2X (No60) 45-60mm	10	£16.17
546174	Size 3 (No70) 50-70mm	10	£17.59
546176	Size 3X (No80) 60-80mm	10	£18.67
546178	Size 4 (No90) 70-90mm	10	£19.86
546180	Size 4X (No100) 80-100mm	10	£19.54
546182	Size 5 (No120) 90-120mm	10	£21.55
546184	Size 6 (No140) 110-140mm	10	£22.00

Mini Hose Clips - Zinc



Part No.	Description	Qty	Price
900890	Size 9 (7-9mm)	50	£16.08
900910	Size 10 (8-10mm)	50	£17.04
900920	Size 11 (9-11mm)	50	£17.23
900930	Size 12 (10-12mm)	50	£17.39
900940	Size 13 (11-13mm)	50	£20.46
900950	Size 14 (12-14mm)	50	£20.59
900960	Size 15 (13-15mm)	50	£21.48
900970	Size 16 (14-16mm)	50	£21.75
900980	Size 17 (15-17mm)	50	£21.93
900990	Size 18 (16-18mm)	50	£22.59

Hose Clips - Zinc



- Used for a wide variety of domestic, automotive & industrial applications

Part No.	Description	Qty	Price
546214	Size 000 (No12) 9.5-12mm	30	£9.57
546210	Size M00 (No16) 11-16mm	30	£9.57
546218	Size 00 (No20) 13-20mm	30	£9.67
546222	Size 0 (No22) 14-22mm	30	£10.71
546258	Size 0X (No25) 17-25mm	20	£8.01
546230	Size 1A (No30) 22-30mm	20	£8.21
546226	Size 1 (No35) 25-35mm	20	£8.14
546234	Size 1X (No40) 30-40mm	20	£8.44
546236	Size 1m (No45) 35-45mm	20	£8.70
546250	Size 2A (No50) 35-50mm	20	£9.92
546235	Size 2 (No55) 40-55mm	20	£9.23
546242	Size 2X (No60) 45-60mm	20	£9.78
546243	Size 3 (No70) 55-70mm	20	£10.81
546259	Size 3X (No80) 60-80mm	20	£13.39
546254	Size 4 (No90) 70-90mm	20	£12.73
546262	Size 4X (No100) 80-100mm	15	£10.88
546264	Size 5 (No120) 90-120mm	15	£12.93
546266	Size 6/6X (No140) 110-140mm	15	£14.55
546270	Size 7 (No160) 130-160mm	10	£11.28

100pc Handy Pack Popular Hose Clips



Contents

- 10 each of
- 000 (9.5-12mm)
 - M00 (11-16mm)
 - 00 (13-20mm)
 - 0 (16-22mm)
 - 0X (18-25mm)
 - 1A (22-30mm)
 - 1 (25-35mm)
 - 1X (30-40mm)
 - 1M (32-45mm)
 - 2A (35-50mm)

£66.21

Part No. 546299

Overbraided Fuel Hose

- For all fuels and biodiesel (limited to Ethanol share up to 20%)
- In accordance with DIN73379-1
- B340774: For BMW and Vauxhall



Part No.	Description	Qty	Price
B340774	20m ID 3.2mm OD 7mm	1	£34.73
B305847	20m ID 3.5mm OD 7.5mm	1	£38.83
B305855	20m ID 4.5mm OD 9.5mm	1	£42.98
B298131	15m ID 5.5mm OD 10.5mm	1	£44.85
B298140	15m ID 7.5mm OD 12.5mm	1	£46.68
B298158	10m ID 10mm OD 15mm	1	£50.92
B402370	10m ID 12mm OD 18mm	1	£57.98

Rubber Fuel Hose

- Suitable for all fuels and biodiesel
- In accordance with DIN73379-1
- B309974: For Daimler Chrysler
- B309990/B310042: For BMW



Part No.	Description	Qty	Price
B307238	15m ID 4.5mm OD 10.5mm	1	£37.09
B307297	15m ID 5.3mm OD 11.3mm	1	£40.48
B307246	15m ID 5.5mm OD 11.5mm	1	£47.98
B307556	15m ID 7mm OD 13mm	1	£50.92
B309966	10m ID 7.3mm OD 13.3mm	1	£26.24
B309893	10m ID 7.5mm OD 13.5mm	1	£33.94
B309974	10m ID 9mm OD 15mm	1	£28.44
B309990	10m ID 9.3mm OD 15.3mm	1	£36.05
B310042	10m ID 11.3mm OD 17.5mm	1	£46.88

Fuel Hose Dispenser c/w Special Hose Shears

- For easy storing and dispensing of fuel hoses
- Locking device: prevents automatic unrolling
- Includes attached shears



£94.58

Part No. B115010

In-Line Fuel Filters

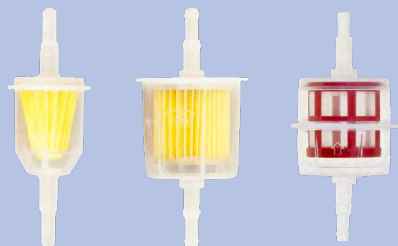

Part No.	Description	Qty	Price
VANDCL62	Small	10	£10.89
VANDCL63	Large	10	£13.94
VANDCL64	Diesel	10	£20.51

Pipe Connector Insertion Tool

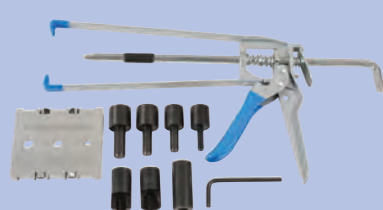

- For use with BT037011
- For fuel/air and vacuum pipes fitted with snap type connectors: can be used in situ so no need to disassemble on the vehicle

£136.14

Part No. BT006933

Fuel Pipe Connector Kit



£225.24

Part No. BT037011

FULL CONTENTS ONLINE

STEP LADDERS

STEP LADDERS

Pro Aluminium Double & Triple Extension Ladders



Reduce fatigue with deep comfortable 'o' rings

Easy to fit stabiliser bar: more secure, helps reduce sideways movements and complies with new legislation

- Available in: 2.5 - 5.5m (double) and 2.5 - 4m (triple)
- Commercial strength box-section construction
- EN131
- 3 year warranty
- 3-5 days delivery

Part No.	Description	Qty	Price
997160	2.5m Double	1	£149.96
997162	3.0m Double	1	£170.24
997164	3.5m Double	1	£191.20
997166	4.0m Double	1	£214.80
997168	4.5m Double	1	£249.61
997170	5.0m Double	1	£269.60
997172	5.5m Double	1	£298.94
997174	2.5m Triple	1	£212.39
997176	3.0m Triple	1	£241.33
997178	3.5m Triple	1	£287.38
997180	4.0m Triple	1	£350.68

Premier XL Platform Step Ladders

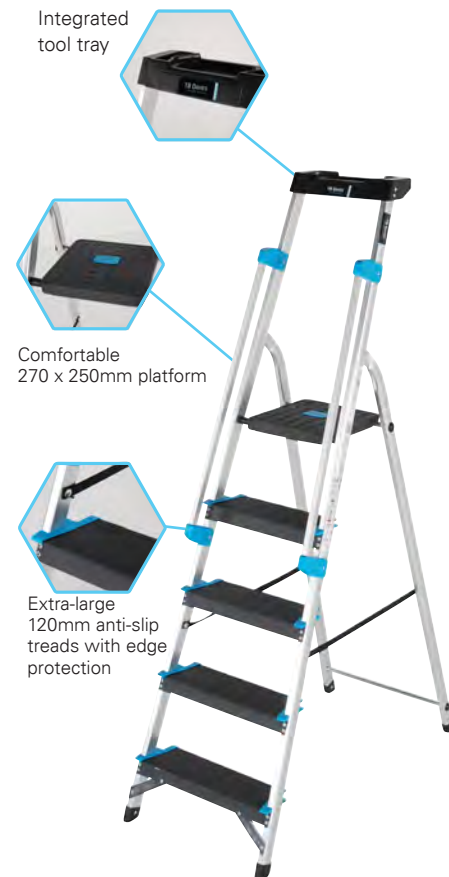

Integrated tool tray

Comfortable 270 x 250mm platform

Extra-large 120mm anti-slip treads with edge protection

- Available in: 3, 4, 5, 6 and 7 tread
- Lightweight and durable
- Twin safety handrails to assist with climbing
- High support rail
- EN131
- 3 year warranty
- 3-5 days delivery

Part No.	Description	Qty	Price
997014	3 Tread	1	£123.27
997015	4 Tread	1	£136.37
997016	5 Tread	1	£150.98
997017	6 Tread	1	£193.31
997018	7 Tread	1	£230.99

21pc Laddertag Kit

- For efficient inspections of ladders
- Contents: 10 x holders, 10 x inserts and 1 pen
- Insert back: displays an easy to use checklist
- Insert front: display area to record inspections

£55.41
Part No. 590320

Fibreglass Swingback Step Ladders



Integrated multi-function tool tray

Comfortable 80mm treads

- Available in: 4, 5, 6, 8 and 10 tread
- Non-conductive fibreglass stiles to 30,000 volts (EN61478), ideal for working around electricity
- EN131
- 3 year warranty
- 3-5 days delivery

Part No.	Description	Qty	Price
997044	4 Tread	1	£86.13
997045	5 Tread	1	£108.27
997046	6 Tread	1	£125.10
997047	8 Tread	1	£184.28
997048	10 Tread	1	£216.41



Little Giant Safety Step with Cage



Safety Cage allows operators to work hands-free in any direction: wrap-around guardrail wraps around the operator (complies to tie-off rules)

Bottom-rung alerts user to last step

- Available in: 4, 6, 8 and 10 tread
- Enclosed Safety Cage® eliminates tie-off requirement
- Compliant with industry rules for three points of contact
- Ground Cue® bottom rung alert lets you know when you've reached the bottom rung.
- Tip & Glide™ wheels increase portability during transportation
- Wheel lift castors allow you to roll the ladder while fully deployed, and lock in place for secure climbing
- Light enough to work on weight-limited stages and upper floors
- Non-conductive fibreglass rails are ideal when working around electricity
- Hi-Viz green fibreglass increases the Cage's visibility, preventing accidental bumping
- The Safety Cage meets or exceeds all safety standards
- Max Load 150kg
- EN131-7:2013
- 1 year warranty

Part No.	Description	Qty	Price
997190	4 Tread	1	£833.63
997191	6 Tread	1	£1003.51
997192	8 Tread	1	£1110.79
997193	10 Tread	1	£1243.22

Little Giant King Kombo 3-in-1 Extension Ladder



Tough corner, pole and stud gripping V-bar

- Ultra-heavy-duty feet with aggressive tread for elite traction
- Tough corner, pole and stud gripping V-bar for the extension ladder position
- Heavy-duty grip conforms to inside and outside corners and even offers protection for damageable leaning surfaces
- Ground Cue™ indicator alerts user to last step
- Wide-flared side offers superior side-tip stability
- 1 year warranty
- 3-5 days delivery

Part No.	Description	Qty	Price
997152	5 Tread	1	£261.03
997153	6 Tread	1	£278.08
997154	8 Tread	1	£366.57

Pro Industrial Platform Step Ladders



Reinforced 330 x 255mm checkerplate platform

Heavy-duty aluminium construction

Comfortable, deep serrated treads

- Available in: 3, 4, 5, 6, 7, 8, 10 and 12 tread
- Heavy-duty aluminium construction
- Box section back legs with heavy duty bracing
- Slip resistant feet produce a firm footing
- EN131 Professional
- 5 year warranty
- 3-5 days delivery

Part No.	Description	Qty	Price
997136	3 Tread Pro	1	£124.18
997137	4 Tread Pro	1	£135.76
997138	5 Tread Pro	1	£148.28
997139	6 Tread Pro	1	£156.01
997141	8 Tread Pro	1	£180.48
997143	10 Tread Pro	1	£211.94
997145	12 Tread Pro	1	£291.71

STEP LADDERS

ACCESS EQUIPMENT

Fiberglass Platform Step Ladders



- Non-conductive fibreglass stiles to 30,000 volts (EN61478), ideal for working around electricity
- Comfortable 80mm treads
- Hinged metal locking stays, provide optimal stability
- Large feet angled to maximise ground contact and reduce slip
- EN131
- 3-5 days delivery
- 3 year warranty

Part No.	Description	Qty	Price
997039	4 Tread	1	£121.54
997040	5 Tread	1	£137.92
997041	6 Tread	1	£166.59
997042	8 Tread	1	£236.79

Probat Step Ladders



- Available in: 4, 5, 6, 8, 10 and 12 tread
- Manufactured from 50mm Aluminium scaffold tube for maximum rigidity and stability
- Extra-strong 390 x 382mm bi-folding platform
- Mammoth 100mm deep steps for maximum climbing support
- Convex oversized feet ensure maximum ground contact and grip
- EN131 Professional
- 5 year warranty
- 3-5 days delivery

Part No.	Description	Qty	Price
997146	4 Tread	1	£327.65
997147	5 Tread	1	£355.72
997148	6 Tread	1	£385.16
997149	8 Tread	1	£454.93
997150	10 Tread	1	£556.66
997151	12 Tread	1	£622.23

Pro Industrial Swingback Step Ladders



- Available in: 3, 4, 5, 6, 8, 10 and 12 tread
- EN131 Professional
- 5 year warranty
- 3-5 days delivery
- Comfortable 80mm treads
- Heavy duty all aluminium construction
- Hinged metal locking stays provide optimal stability
- Box section back legs with heavy-duty bracing
- Slip resistant feet provide a firm footing

Part No.	Description	Qty	Price
997126	3 Tread	1	£78.34
997127	4 Tread	1	£79.98
997128	5 Tread	1	£87.35
997129	6 Tread	1	£99.80
997131	8 Tread	1	£122.53
997133	10 Tread	1	£143.27
997135	12 Tread	1	£173.24

Bridging Steps

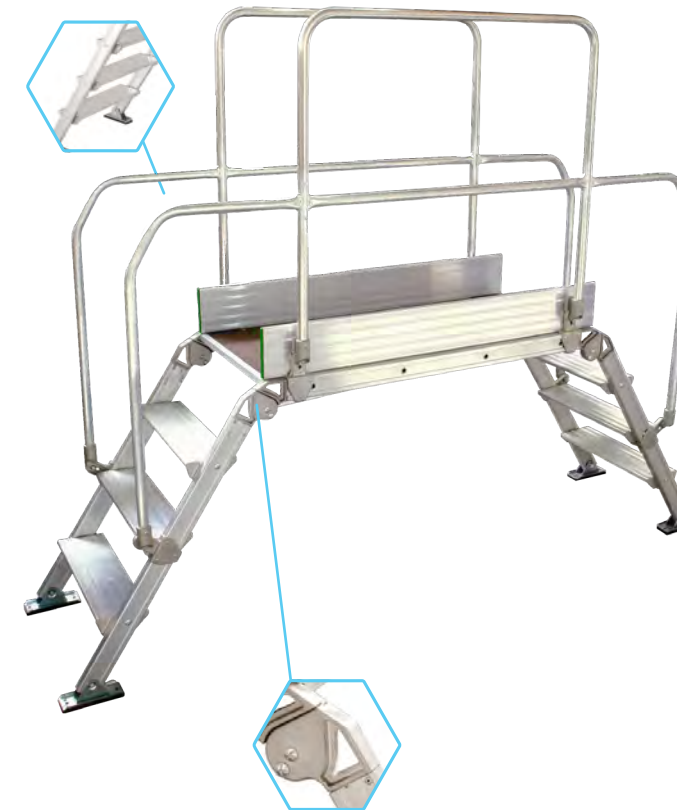

- Ideal for use in factories and distribution centres for safe access over machines and conveyor systems
- 150mm deep steps with handrails on both sides of the platform for maximum safety
- Comfortable climbing angle
- Durable slip and wear resistant platform
- Can be used free-standing or secured to the floor
- Robust aluminium die-cast hinges
- Delivery time may vary as product is made to order
- 5 Year Warranty

90 x 53cm

Part No.	Description	Qty	Price
997053	3 Tread	1	£706.49
997054	4 Tread	1	£747.53
997055	5 Tread	1	£799.40
997056	6 Tread	1	£855.57
997057	7 Tread	1	£918.28
997058	8 Tread	1	£983.09
997059	9 Tread	1	£1,052.22

120 x 53cm

Part No.	Description	Qty	Price
997060	3 Tread	1	£691.69
997061	4 Tread	1	£890.38
997062	5 Tread	1	£926.89
997063	6 Tread	1	£1,1035.58
997064	7 Tread	1	£1,124.41
997065	8 Tread	1	£1,568.31
997066	9 Tread	1	£1,181.55

2-Tread Trade Aluminium Folding Platform EN 14183



- EN 14183 Approved folding and portable aluminium platform with 150kg capacity
- Large, ribbed non-slip platform and treads for safe and easy manoeuvrability
- Durable aluminium alloy frame with ribbed feet provides extra stability
- Safety locking catches on legs
- Folds flat for easy storage and transportation
- Dimensions: (W x D x H) 495 x 1280 x 500mm
- Platform size: 300 x 950mm

£129.95
Part No. APS2

WAREHOUSE STEPS

WAREHOUSE STEPS

X Tower Platforms



- Available in 2m and 2.8m
- Can be erected in just three minutes by one person with the minimum of training from the ground for maximum safety due to telescopic design
- Compact design: can be stored and transported inside a small van
- 3 year warranty
- 10-15 days delivery
- EN1004

Part No.	Description	Qty	Price
997103	X-Tower 2.8m Platform	1	£3,130.51*

*Prices subject to change, please call for latest prices.

Easy-Rise Steps with Truck/Dock Platforms



- Large working top platform: ideal for loading and unloading items from vehicles in storage areas
- Designed to allow user to descend the steps facing forward
- Fitted with hand lock anchorage
- 10-15 days delivery
- 1 Year Warranty
- Large platform with removable chain on end and both sides for 3-sided access
- Comfortable 750mm wide treads
- 48-degree shallow slope for extra safety
- Easy one user manoeuvrability on 4 x rolling wheels
- Optional extras available for full customisation
- Platform size 750 x 1200mm

Part No.	Description	Qty	Price
997097	4 Tread	1	£1,1169.86
997098	5 Tread	1	£1,201.88
997099	6 Tread	1	£1,308.78
997100	7 Tread	1	£1,471.95
997101	8 Tread	1	£1,514.97

Heavy Duty Mobile Safety Steps with Anti Slip Treads



- Available in 4, 5, 6, 7, 8, 9, 10, 12, 14 and 15 Treads
- Extra wide 700 x 180mm deep treads for comfort and safety
- Large 700 x 560mm platform with intermediate guardrails and toe boards
- Fully welded steel construction
- 1 year warranty
- 10-15 days delivery
- EN131-7
- Easy one user manoeuvrability on 4 x rolling wheels

Part No.	Description	Qty	Price
997105	4 Tread	1	£507.08
997106	5 Tread	1	£572.60
997107	6 Tread	1	£684.39
997108	7 Tread	1	£793.26
997109	8 Tread	1	£847.17
997110	9 Tread	1	£1,237.93
997111	10 Tread	1	£1,128.66
997112	12 Tread	1	£1,221.44
997113	14 Tread	1	£1,425.58
997114	15 Tread	1	£1,543.53

Heavy Duty Mobile Safety Steps with Punched Treads

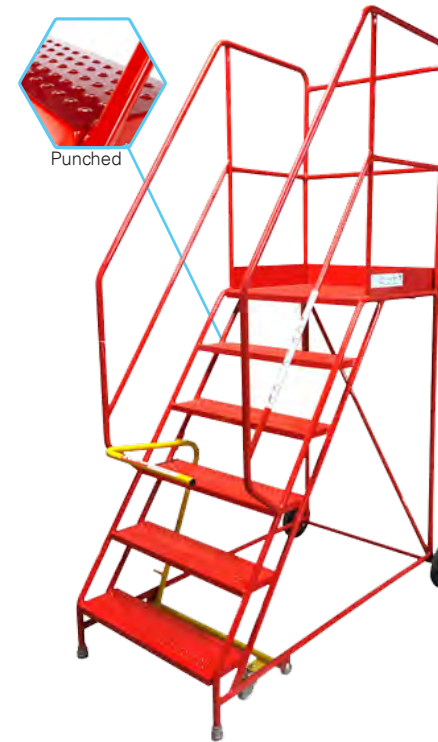

- Available in 4, 5, 6, 7, 8, 9, 10, 12, 14 and 15 Treads
- Extra wide 700 x 180mm deep treads for comfort and safety
- Large 700 x 560mm platform with intermediate guardrails and toe boards
- Locking device and anti-ascent bar
- 1 year warranty
- 10-15 days delivery
- EN131-7

Part No.	Description	Qty	Price
997070	4 Tread	1	£543.98
997071	5 Tread	1	£614.31
997072	6 Tread	1	£734.09
997073	7 Tread	1	£848.78
997074	8 Tread	1	£908.77
997075	9 Tread	1	£977.79
997076	10 Tread	1	£1,207.67
997078	12 Tread	1	£1,310.41
997080	14 Tread	1	£1,429.37
997081	15 Tread	1	£1,543.53

Mobile Safety Steps with Anti Slip Treads



- Available in 4, 5, 6, 7, 8, 9, 10, 12, 14 and 15 Treads
- Strong tubular steel construction for commercial applications with double handrail
- Toe-boarded platform and enclosed guardrail for assured working and stock picking
- Locking device and anti-ascent bar
- Comfortable 560 x 400mm platform
- Fully welded tubular steel construction
- EN131-7
- 1 year warranty
- 10-15 days delivery

Part No.	Description	Qty	Price
997116	4 Tread	1	£443.98
997117	5 Tread	1	£503.47
997118	6 Tread	1	£610.40
997119	7 Tread	1	£707.42
997120	8 Tread	1	£743.32
997121	9 Tread	1	£814.35
997122	10 Tread	1	£977.27
997123	12 Tread	1	£1,1173.27
997124	14 Tread	1	£1,299.82
997125	15 Tread	1	£1,437.53

Mobile Safety Steps with Punched Treads



- Available in 4, 5, 6, 7, 8, 9, 10, 14 and 15 Treads
- Strong tubular steel construction for commercial applications with double handrail, toe-boarded platform and enclosed guardrail for assured working and stock picking
- Locking device and anti-ascent bar
- Comfortable 560 x 400mm platform for assured stock picking
- Fully welded tubular steel construction
- EN131-7
- 1 year warranty
- 10-15 days delivery

Part No.	Description	Qty	Price
997084	4 Tread	1	£488.38
997085	5 Tread	1	£553.82
997086	6 Tread	1	£671.44
997087	7 Tread	1	£778.16
997088	8 Tread	1	£817.65
997089	9 Tread	1	£882.75
997090	10 Tread	1	£1,127.65
997092	12 Tread	1	£1,290.60
997094	14 Tread	1	£1,429.80
997095	15 Tread	1	£1,622.80



NEW FEATURES

- You can see in real time the temperature of the heated space, the amount of fuel and whether the heater is running right now from your phone
- Automatic restart after a power outage
- The burner is now quieter, more reliable and lower nitrogen oxide emissions
- With the revamped burner, the piping has also been redesigned for cleaner combustion
- The fuel cap was replaced with a fully sealed model that prevents fuel spillage when moving the heater
- The grid protecting the ceramic piping has been reinforced and improved
- Stylish darker graphite grey colour

EXAMPLE OF CONSUMPTION

Part No. 444012

Insulated industrial hall
Volume 500m³
Outside temperature: 0°C
Inside temperature: +15°C
Fuel consumption/day: approx. 2.5litres

WHY SHOULD YOU CHOOSE A FUEL-FIRED AIRREX HEATER?

- Airrex infrared heaters have been manufactured for 30 years
- 100% efficiency
- No need for a separate exhaust pipe / chimney, no wasteful heat loss outdoors
- Normal ventilation is sufficient
- Extremely low consumption
- Mobile, no need for fixed mounting
- Instead of air, the infrared radiation heats material providing even heat distribution without an energy-consuming fan
- Does not create dust or pick up dust from the floor
- Thermostat controlled (0 to 40°C)
- Low power consumption: 80W (230V, 50Hz)
- Quiet, only 48dB
- No burning hot surfaces
- Availability guarantee of spare parts: we guarantee that the spare part you need is always available directly off the shelf
- Warranty servicing is always carried out on-site with the customer - effortlessly and efficiently!
- 3-year warranty, activated at www.rexnordic.com

WiFi Feature

You can adjust the temperature and check the fuel level direct from your phone



For summer cottages, glass terraces or garages, etc

£POA

Part No. 444010



For halls, warehouses, event tents, terraces, etc

£POA

Part No. 444012



For large industrial halls and event tents

£POA

Part No. 444014

Finance Available

Please call for more information - 01383 729814

WHAT CUSTOMERS THINK

"It is great as you can move the heater around to different parts of the business when required."

"I am really impressed with how quickly the heater heats the workshop up in the morning!"

"The heater has paid for itself in 7 weeks! I am spending £5.60 per day vs £56.80 for a propane heater."

Perfect for bodyshops as does not create dust or pick up dust from the floor

Comparison Table		Part No. 444010	Part No. 444012	Part No. 444014
Heating capacity	kW/h	13	15	22
Suitable for spaces up to	m ³	900	1,500	2,000
Fuel consumption (continuous heating)	litres /h	0.95–1.14	1.05–1.24	17.1–1.9
Fuels		Biodiesel, Diesel, Red Diesel		
Fuel tank volume	Litres	25	45	70
Power supply		●	●	●
Power consumption		Ø 1 x 230 V x 50 Hz		
Power consumption	W	80W		
Thermostat adjustment range	°C	0–40		
Noise level	dB	48		
Dimensions (W x D x H)	mm	780 x 305 x 945	950 x 305 x 1010	1300 x 350 x 1340
Weight	kg	40	46	81
Spare parts warranty		●	●	●
Warranty	Years	3		
Compliant with EU's emissions regulations		●	●	●

Cartridge Dispensers



Part No.	Description	Qty	Price
1 BN002	2L Dispenser	1	POA
2 310508	4L Dispenser	1	POA

1L Deb Instant Foam Hand Sanitiser

- Kills 99% of many common germs
- Proven hypoallergenic formula



Part No.	Description	Qty	Price
310197	1L Deb Instant Foam	6	£84.46
310200	Dispenser	1	POA

Deb Pure Restore

- Proven to provide protection against aqueous solutions, oils and solvents



Part No.	Description	Qty	Price
310256	1L Deb Pure Restore	1	£18.67
310257	1L Deb Pure Restore	6	£112.21
310500	Dispenser	1	POA

1L Deb Universal Protect Cream

- A pre work skin cream which helps protect against water based and non-water based contaminants



Part No.	Description	Qty	Price
603610	1L Deb Universal Protect	1	£17.33
310506	Dispenser	1	POA

Deb Pure Wash

- Perfume-free and dye-free light duty lotion hand cleanser for regular use to remove general dirt and grime



Part No.	Description	Qty	Price
310185	1L Deb Pure Wash	6	£54.16
310316	2L Deb Pure Wash	1	£10.64
310187	4L Deb Pure Wash	4	£76.76

Deb Lotion Wash

- A highly effective lotion hand cleaner for general hand cleaning



Part No.	Description	Qty	Price
603613	2L Deb Lotion Wash	4	£41.01
603615	4L Deb Lotion Wash	4	£88.94

1L Deb Azure Foam Hand Wash

- A mild, biodegradable foam hand wash with added moisturisers to help prevent drying and leave the skin feeling smooth after use



Part No.	Description	Qty	Price
310650	1L Deb Azure Foam	1	£12.51
310504	Dispenser	1	POA

Deb Lime Wash

- Oil, grease, dirt and grime
- Medium to heavy duty hand wash



Part No.	Description	Qty	Price
310320	2L Deb Lime Wash	1	£15.85
310318	4L Deb Lime Wash	1	£25.10

4L Swarfega Orange Hand Cleaner

- Solvent-free heavy duty hand cleanser containing non-abrasive scrubbers for a deep-down cleaning action and moisturiser to help care for the skin



£36.87

Part No. 310254

Deb Citrus Powerwash

- Removes a wide range of ingrained and difficult to remove industrial soilings from oil and grease to many paints and adhesives



Part No.	Description	Qty	Price
310321	2L	1	£20.87
310192	4L	1	£35.38
310194	4L	4	£144.31

Pink Pearl Hand Soap



Part No.	Description	Qty	Price
BK101-50	500ml Bottles	6	£20.16
BK101-5	5L	1	£11.19

5L Rozalex Dri-Guard Barrier Cream



£51.25

Part No. 310216

Floor Stand for Cleaning Roll

- Paper roll sold separately (AF201)



£38.35

Part No. B162401

Paper Roll Wall Holder



- Paper roll sold separately (AF201)

£33.07

Part No. B162400

150m Blue Centrefeed Rolls 2-Ply



- Pack of 6

£15.86

Part No. AF113

360m x 280mm Blue Industrial Roll 2-Ply



- Pack of 2

£23.65

Part No. AF201

360m x 390mm Blue Industrial Roll 3-Ply



- Pack of 1

£27.94

Part No. AF215

380m x 220mm Blue Industrial Roll 3-Ply



- Pack of 2

£35.96

Part No. 700001

380m x 380mm Blue Industrial Roll 3-Ply



- Pack of 1

£37.92

Part No. 700146

170m x 260mm 3-ply Blue Embossed Wiper Roll

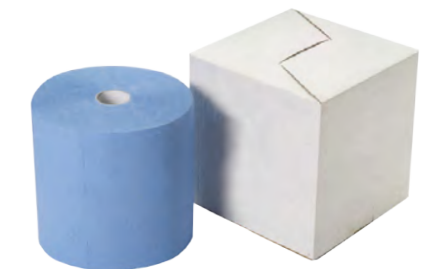

- Pack of 1

£14.44

Part No. AF301

360m x 280mm White Industrial Roll 2-Ply



- Pack of 2

£23.65

Part No. AF200

190mm x 160m Katrin Classic M2 System Towel 2-ply



- Pack of 6

£54.67

Part No. B460102

150m x 190mm White Centrefeed 2-Ply



- Pack of 6

£19.54

Part No. AF114

White Z-Fold Hand Towel 2-Ply (3000 Sheets)



£36.42

Part No. AE204

White Luxury Hand Towel 2-Ply (3045 Sheets)



£43.64

Part No. AE208

76m x 200mm Green Roll Towel 1-Ply



• Pack of 16

£26.93

Part No. 700035

C-Fold Hand Towels



Part No.	Description	Qty	Price
AE115	Blue 1-Ply (2880 sheets)	1	£22.53
AE116	Green 1-Ply (2880 sheets)	1	£22.53
780222	White 2-Ply (2400 sheets)	1	£25.27
700200	360 x 276 x 215mm Dispenser	1	£28.48

20m x 95mm x45 mm Toilet Roll (200 Sheet/2-Ply)



• Pack of 36

£11.20

Part No. AC002

32m x 90mm x 50mm Toilet Roll 4 Pack (320 Sheet 2-Ply)



• Pack of 36

£15.17

Part No. AC003

32m x 95mm x 45mm Toilet Roll 36 Bulk Pack (320 Sheet 2-Ply)



• Pack of 36

£16.30

Part No. AC110

200mm x 100mm Toilet Tissue (250 Sheet 2-Ply)



• Pack of 36

£24.21

Part No. AB101

Premium Triple Soft Toilet Roll 3-Ply



• Pack of 40

£23.73

Part No. 500366

400m x 90mm Jumbo Toilet Roll (6 Case 2-Ply)



• Pack of 6

£23.13

Part No. AD205

300m x 90mm x 60mm Jumbo Toilet Roll 2-Ply



Part No.	Description	Qty	Price
AD402	Toilet Roll	6	£15.59
700195	White Dispenser	1	£26.52

5L Floor Gel



Part No.	Description	Qty	Price
991120	GP Lemon	1	£9.30
991122	Pine	1	£8.52

5L Rubicon Heavy Duty Cleaner



£16.82

Part No. BA060-5

Bleach



Part No.	Description	Qty	Price
BC015-75	750ml Thick	1	£1.76
BC015-5	5L Thick	1	£3.71
BC014-5	5L Thin	1	£3.28

5L Low Foam Heavy Multi Surface Cleaner



£9.47

Part No. BD061-5

Glass & Mirror Cleaner



Part No.	Description	Qty	Price
BA030-75	750ml	6	£15.44
BA030-5	5L	1	£9.75

Everfresh Perfumed Toilet & Washroom Cleaner



Part No.	Description	Qty	Price
BC040-6	1L	6	£14.72
BC040-5	5L	1	£7.68

5L Versatile Hard Surface Cleaner



£6.80

Part No. BA001-5

750ml Surface Polish



£3.32

Part No. BA020-75

Thick Toilet Cleaner/Descaler



Part No.	Description	Qty	Price
BC050-1	1L	1	£4.11
BC050-5	5L	1	£7.43

Mystrol Multi-Purpose Cleaner



Part No.	Description	Qty	Price
BA010-75	750ml	1	£2.88
BA010-5	5L	1	£13.52

Q'Sol Washing Up Liquid



Part No.	Description	Qty	Price
BB028-1	1L	1	£2.53
BB028-5	5L	1	£9.36

Disinfectant



Part No.	Description	Qty	Price
BA050-75	750ml	1	£2.88
BC018-5	5L Pine	1	£4.42
BC017-5	5L Floral	1	£6.17

Enclosed Toilet Brush & Holder



£9.81

Part No. HN200

Open Toilet Brush & Holder



£2.41

Part No. HN204

14 x 9 x 3.5cm Caterers Sponge Scourers

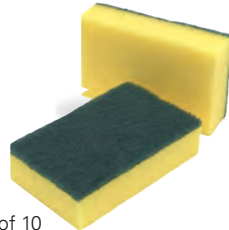

• Pack of 10

£3.61

Part No. 700149

230 x 150mm Contract Scouring Pad



• Pack of 10

£3.18

Part No. HL008

30cm Brass Channel and Rubber C/W Handle



£11.63

Part No. CD030/CD034

24L Window Cleaners Bucket



£18.33

Part No. CD001

1.1kg Biological Urinal Blocks

• Contains a powerful biological cleaning agent, proven to maintain and deodorise traps and pipe work



£19.28

Part No. BC077

3kg Non PDCB Urinal Blocks



• Suitable for use in all types of urinals, especially where safer cleaning materials are required, e.g institutions, schools and public buildings

£22.21

Part No. BC078

SM1705 Servomatic Trolley



- 120L lidded waste capacity, twin 10L or 4 x 5L industry colour-coded buckets and easy-access and open shelf storage, maximising on-board storage options
- Engineered from the highest quality recycled material using environmentally sustainable ReFlo Technology making it tough, chemical-resistant, easy to clean and built to last

£253.29

Part No. 810590

Karcher Dry Tub Vacuum T 7/1 Classic

- Suction hose: 2m
- Suction pipe: 3 piece(s), 0.35m
- Filter bag: Fleece
- Floor tool



£109.30

Part No. 744548

KÄRCHER

Karcher Professional Range – see pages 232-233

500ml Graffiti Remover

- Removes paint, varnish and graffiti from surfaces such as glass, steel, surfaces painted with 2-component enamel or stove enamel, PP, PVC and GRP etc
- Fast acting
- Does not erode the material
- Silicone and AOX free



£6.45

Part No. B408113

Paint and Graffiti Remover Wipes (150 wipes)

- Effective wipe for the safe removal of paint overspray, permanent marker, ink & general graffiti from non porous surfaces including polycarbonates



£15.84

Part No. 310744

Mechanics Wipes (150 Wipes)

- Effective removal of inground oil, grease, tar, silicone, and paint from hands
- Dermatologically tested and approved
- Anti-bacterial - effective against a whole host of bacteria and pathogen including E-Coli, Listeria, Salmonella, MRSA and H1N1
- Contain Aloe Vera to leave hands and skin clean and soft after use
- These hand wipes are also ideal for cleaning tools and equipment



£11.74

Part No. 310742

750ml Giant Air Fresheners



- High pressure powerful aerosols
- Clears unwanted odours quickly
- Long lasting 750ml aerosol

Part No.	Description	Qty	Price
BG030-CR	Cranberry	1	£6.92
BG030-CG	Citrus Grove	1	£6.92

750ml Odour Neutraliser

- Highly effective, quick acting, ready to use formulation
- Eliminates malodours from carpet, fabric and hard surfaces
- Contains soil and stain resistant agents
- Suitable for use against urine, tobacco smoke, rancid food and pet odours
- Low environmental impact rated



£3.26

Part No. BA037-75

750ml Fresh Air Freshener

- Neutralises tobacco and cooking aromas
- Recommended for wiping hard surfaces or adding to a carpet shampoo solution
- Contains a long lasting, wild berry fragrance



£4.06

Part No. BA032-75

5L Tar & Glue Remover

- Removes tar and glue from all hard, solvent-resistant surfaces
- Safe to use on metals
- Ideal for the removal of most sealants, adhesives and stubborn areas of new car delivery wax
- Silicone free and suitable for use in bodyshops



£19.62

Part No. 990081

500ml Adhesive Remover NSF K3

- Quickly dissolve and remove adhesive residues from tape, label adhesive, price tags, information labels, adhesive foil on boxes, machines, barrels, cans, shelves, cars and trucks



£7.02

Part No. B408518

Exel Revolution Mop Heads



Part No.	Description	Qty	Price
HA009-B	Blue 200g	1	£3.89
HA009-R	Red 200g	1	£3.89
HA011-B	Blue 300g	1	£4.40

Exel PY Socket Mop Heads



Part No.	Description	Qty	Price
HA014-B	Blue 200g	1	£1.64
HA015-B	Blue 250g	1	£1.93
HA015-R	Red 250g	1	£1.93
HA016-B	Blue 300g	1	£2.59
HA016-R	Red 300g	1	£2.59

Exel Twine Socket Mop Heads



Part No.	Description	Qty	Price
HA022-B	Blue 300g	1	£2.26
HA022-R	Red 300g	1	£2.26
HA022-G	Green 300g	1	£2.26

No.14 PY Yarn Socket Mop Head



Part No.	Description	Qty	Price
HA050-14	220g - Metal	1	£2.19
HA051-14-B	240g - Plastic	1	£1.82

3 Gal Black Plastic Contractors Bucket



£3.49
Part No. 700056

14L Mop Buckets with Wringer



Part No.	Colour	Qty	Price
CL056-B	Blue	1	£6.58
992674	Red	1	£6.58

13L H/D Galvanised Mop Bucket



£21.77
Part No. 700054

54" Exel Mop Handles

- Lightweight aluminium handle with colour coded grip & easy push fit fitting for Exel® sockets



Part No.	Colour	Qty	Price
HA025-B	Blue	1	£8.05
HA025-R	Red	1	£8.05
HA025-G	Green	1	£8.05
HA025-Y	Yellow	1	£8.05

Kentucky Mop



Part No.	Description	Qty	Price
HA006-B	Aluminium Handle Blue	1	£7.12
HA004-34	340g Twine Mop Head	1	£2.84

3 1/4" Nail Brushes



Part No.	Description	Qty	Price
700048	Hard Wooden Nail Brush	1	£1.07
HN076-W	White Nylon Nail Brush	1	£0.76

600mm Wide Floor Squeegee and Shaft



£15.93
Part No. 700047

45cm Plastic Floor Squeegee Blue



£14.10
Part No. HQ015-B

Brooms with Handles



1213 x 24mm Wooden Broom Handle



£1.72
Part No. HN020

12" Natural Coco Soft Broom Head



£4.79
Part No. 800050

Dust Pan & Soft Brush Sets



Part No.	Colour	Qty	Price
HN070-R	Red	1	£3.23
HN070-Y	Yellow	1	£3.23

Magnetic Sweepers with Extending Handle

Helps to cut down on punctures!



- Efficient method for clearing large quantities of hazardous ferrous metal objects, such as nails, tacks, nuts etc
- Keeps work areas clear of dangerous ferrous metal
- Ideal for busy workshops, garages and construction sites
- User-friendly design: no external power required to operate
- Strong aluminium exterior
- Corrosion resistant
- Quick load-release handle clears the collected metal
- Mobile on two rubber wheels

Part No.	Description	Qty	Price
816492	760-1100mm with 13kg capacity	1	£111.84
816494	950-1290mm with 90kg capacity	1	£194.56

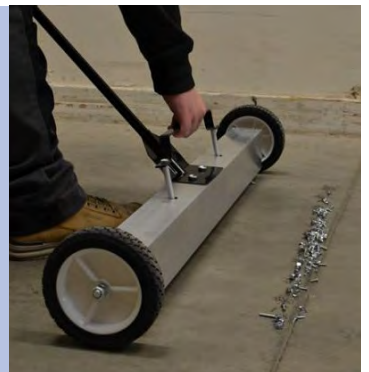

85L Refuse Bins



Part No.	Description	Qty	Price
CL008-B	Black Plastic	1	£16.35
990007	Heavy Duty Galvanised	1	£28.23

18 x 29" Refuse Sacks



Part No.	Colour	Qty	Price
CM140-34	34" Black	200	£13.66
CM140-39	36" Black	200	£14.76
CM180	39" Black	200	£23.02
CM160-C	39" Clear	200	£32.57

32" Easy Grip Mechanical Gripper



- Litter picker enables the extra reach required to retrieve litter from trees, gullies and ditches
- Crafted in high quality aluminium, extra long litter picker

£22.23
Part No. CA024

Shovels



Part No.	Description	Qty	Price
700140	Metal Hand Shovel	1	£5.36
990178	Square Mouth Builders Shovel	1	£20.65

250mm Vehicle Washing Brush with Water Channel



£23.30

Part No. B011268

270mm Quatro Washing Brush



£18.48

Part No. B119202

270mm Triple Washing Brush



£10.02

Part No. B119201

2.4m Telescopic Handle For Washing Brush with Water Feed



£34.36

Part No. B366763

160 x 110 x 60mm Car Sponge



£1.66

Part No. B103866

480mm Wheel Rim Brush



£6.13

Part No. B011274

200mm Hand-Held Washing Brush



£14.19

Part No. B011272

280mm Washing Brush with Integrated Water Tank



£8.32

Part No. B011282

10kg Rags



Part No.	Description	Qty	Price
1	B200116 White Sheeting	1	£28.06
2	B200117 Coloured Towelling	1	£24.06
3	B200118 Coloured Sweatshirt	1	£14.77

400mm x 400mm Microfibre Cloths



Part No.	Description	Qty	Price
B243752	Soft Cloths	5	£10.66
CG106-B	Soft Cloths	10	£9.91
CG106-P	Soft Cloths	10	£9.91

X-IN-1 MULTI FOAM CLEANER
One product for all surfaces

Save Time, Save Cost with one product instead of 10

- Suitable for the entire interior cleaning including glass, mirror and displays
- No product change needed between different surfaces
- 500ml can

£5.82

Part No. B408468



CLEAN WITH HIGHEST CARE & QUALITY



Exterior Cleaning



< Dissolves and removes tar, bitumen and pollution stains on painted surfaces, glass and plastics



< Cleans and maintains vehicle tyres

> For cleaning bodywork, wheels and undercarriages



A neutral car wax shampoo with an exceptionally high degree of cleaning power



> Removes stubborn brake dust, dirt, oil, grease and other pollution



Part No.	Description	Qty	Price
1	B147992 400ml Tar Remover	1	£4.62
2	B408495 500ml Tyre Foam	1	£6.59
3	B408476 25L ACTIVE Vehicle Shampoo	1	£43.60
4	610295 5L Wash and Shine Car Shampoo	1	£8.23
5	B409471 500ml Wheel Rim Cleaner	1	£5.34

Interior Cleaning



< Protection, cleaning and maintenance of plastic, rubber parts, dashboards and door interiors



< Cleaning of car seats, inside door panels, roof lining and car mats



> Streak-free environmentally friendly cleaning of glass, windscreens, mirrors etc

Part No.	Description	Qty	Price
1	B690112 400ml Cockpit Spray	1	£5.27
2	B148017 400ml Upholstery Cleaning Foam	1	£5.28
3	B216401 400ml ACTIVE Glass Cleaner	1	£5.09

5g Black Nitrile Powder Free Gloves

- Excellent puncture and tear resistance
- Chemical resistance
- Maximum dexterity enables better performance in intricate tasks
- Powder-free
- Comfortable to ensure hand fatigue is reduced
- Good grip helping to ensure movement is completely unrestricted



Part No.	Size	Qty	Price
307005	S	100	£12.50
307006	M	100	£12.50
307007	L	100	£12.50
307008	XL	100	£12.50

5pc Disposable Vehicle Interior Protection Set (Pk 100)



£46.24

Part No. B132311

Magnetic Wing Cover



- To protect the mudguard during repair and maintenance work
- Universal - fits all cars
- Optimal grip on the vehicle due to strong magnets
- No damage to the paintwork thanks to foam coating on the inside
- Resistant to oil and acid
- Size: 1100 x 650mm

£29.10

Part No. B715123

Grille Cover with Hooks



- Protects the front of the vehicle during repair and maintenance work
- Universal for all cars
- Optimal grip on the vehicle
- No damage to the paintwork thanks to foam coating on the inside
- Resistant to oil and acid
- Size: 1200 x 650mm

£32.63

Part No. B043752

Nylon Bumper & Wing Cover



- Protects the front and fenders in the workshop
- Fits perfectly on all car types
- Attachment to car with straps and hooks
- Protector is light and air permeable at the height of the grille and lights
- User friendly

£69.72

Part No. B209184

5L Aluminium Cleaner



- For the cleaning and brightening of aluminium and its alloys
- Also suitable for the descaling of industrial and kitchen equipment
- Dilute 1 part to 5 parts water

£13.89

Part No. BG240-5

White Magic Eraser Sponge



• Qty: 10

£14.99

Part No. 900658

Disposable Seat Covers (Pk 500)



- Length - 1350mm
- Type - Seat Covers
- Width - 820mm

£62.00

Part No. B677299

1300 x 790mm Disposable Seat Covers Roll - 10 Micron

- White polythene seat cover in dispenser box
- Suitable for vehicles with head rests
- Pack of 100



£18.14

Part No. 610210

500 Paper Floor Mats on Roll



£49.72

Part No. 610216

380 x 500mm Brown Paper Footmats



- Pack of 250

£17.39

Part No. 610211

Sealtex Jacket Yellow

- Waterproof with welded seams to prevent water penetration
- Vented back yoke and eyelets for added breathability and comfort
- Stud adjustable cuffs for a secure fit
- Concealed stud and zip fastening
- Generous fit for wearer comfort
- Durable and stretchy with wipe clean finish
- Double storm flap to protect against the elements
- 2 pockets for secure storage
- Extremely water resistant fabric finish, water beads away from fabric surface
- Pack away hood for added functionality
- Two-way zip for quick and easy access



Part No.	Size	Qty	Price
DB101-Y-S	Small	1	£40.51
DB101-Y-M	Medium	1	£40.51
DB101-Y-L	Large	1	£40.51
DB101-Y-XL	XL	1	£40.51

Sealtex Trousers Yellow

- Waterproof with welded seams to prevent water penetration
- Durable and stretchy with wipe clean finish
- Fully elasticated waistband for ultimate wearer comfort
- Stud adjustable hems for a secure fit
- Generous fit for wearer comfort
- Extremely water resistant fabric finish, water beads



Part No.	Size	Qty	Price
DB102-Y-S	Small	1	£25.50
DB102-Y-M	Medium	1	£25.50
DB102-Y-L	Large	1	£25.50
DB102-Y-XL	XL	1	£25.50

1300 x 840mm HDPE Disposable Seat Covers

- HDPE Polythene
- Manufactured to a full seat size allowing them to comfortably fit all seats including head rests in vehicles up to HGV size



Part No.	Description	Qty	Price
610205	10 Micron	100	£21.02
610202	18 Micron	100	£25.51

Universal Nylon Seat Cover



- Extremely durable and tear resistant
- Made of long-lasting nylon

£14.49

Part No. B200915

Universal Nylon Steering Wheel Cover



- For use when vehicles are being serviced
- Reusable cover

£3.15

Part No. B043993

PROFESSIONAL RANGE

PROFESSIONAL RANGE

Karcher Cold Water Pressure Washer HD



- Equipment:
- Trigger gun, EASY!Force
 - High-pressure hose: 10m
 - Spray lance: 840 mm
 - Triple nozzle (0°/25°/40°): Manual
 - Dirt Blaster spray lance
 - Pressure switch control

- 5/12 C Plus**
- Flow rate (l/h) : 500
 - Max pressure: 175/17.5 (bar/MPa)
- 6/13 C Plus**
- Flow rate (l/h) : 590
 - Max pressure: 190/19 (bar/MPa)

POA Part No. 744502

POA Part No. 744504

Karcher Cold Water Pressure Washer HD 6/13 CX Plus



- Equipment:
- Trigger gun, EASY!Force
 - High-pressure hose: 15m
 - Spray lance: 840 mm
 - Triple nozzle (0°/25°/40°): Manual
 - Dirt Blaster spray lance
 - Hose reel
 - Pressure switch control
 - Flow rate (l/h): 590
 - Max pressure: 190/19 (bar/MPa)

POA Part No. 744506

Karcher Cold Water Pressure Washer HD 7/12-4 M Plus



- Equipment:
- Trigger gun, EASY!Force
 - High-pressure hose: 10m
 - Spray lance: 840 mm
 - Power nozzle
 - Dirt Blaster spray lance
 - Pressure switch control
 - Quick coupling
 - Flow rate (l/h): 700
 - Max pressure: 180/18 (bar/MPa)

POA Part No. 744508

Karcher Dry Tub Vacuum T 7/1 Classic



- Suction hose: 2m
- Suction pipe: 3 piece(s), 0.35m
- Filter bag: Fleece
- Floor tool

£109.30 Part No. 744548

Karcher Dry Vac Back Pack BV 5/1 Battery



- Suction hose: 1.5m
- Telescopic suction tube: Standard
- Filter bag: Fleece
- Washable nylon filter (main filter)
- Switchable floor nozzle, 290mm
- Clip system for extension hose

£774.58 Part No. 744550

Karcher Wet & Dry Vacuum NT 27/1



- Suction hose: 2.5m
- Suction pipe: 2 piece(s): 0.5m
- Filter bag: Paper
- Wet and dry floor tool: 300mm
- Cartridge filter
- Sturdy bumper

£232.85 Part No. 744552

Karcher Hot Water Steam Pressure Washer HDS 7/10 4M



- Flow rate (l/h): 350 - 700
- Operating pressure (bar/MPa): 30/100/3/10
- Max. temperature (°C): 80 - 155
- Consumption fuel oil (kg/h): 4.6

POA Part No. 744516

Karcher Hot Water Steam Pressure Washer HDS 6/12 C



- Flow rate (l/h): 240 - 560
- Operating pressure (bar/MPa): 30/120/3/12
- Max. temperature (°C): 80 - 155
- Consumption fuel oil (kg/h): 3.5

POA Part No. 744512

Karcher Hot Water Steam Pressure Washer HDS 6/10 C



- Flow rate (l/h): 240 - 560
- Operating pressure (bar/MPa): 30/100/3/10
- Max. temperature (°C): max. 80
- Consumption fuel oil (kg/h): 3.5

POA Part No. 744514

Karcher Wet & Dry Vacuum NT 22/1 AP Te



- Suction hose: 1.9m
- Suction pipe: 2 piece(s), 0.5m
- Filter bag: Fleece
- Wet and dry floor tool: 300mm
- Connector for electric tools
- Automatic on/off control for electric power tools
- Caster with brake

Part No.	Description	Qty	Price
744554	NT 22/1 AP Te 240v	1	£234.04
744556	NT 22/1 AP Te 110v	1	£234.04

Karcher Carpet/Upholstery Cleaner Puzzi 8/1



- Spray hose with integral water feed: 2.5 m
- Integral accessory holder for hand tool
- Power cable: 7.5 m
- Upholstery nozzle
- Cable hook
- Hand tool

£540.54 Part No. 744540

Karcher Handheld Battery Vacuum HV 1/1 FS



- Ideal for the maintenance of smaller car pools for which the purchase of large vacuum cleaners is not necessarily economical
- Strong suction power
- Long battery runtime
- Light weight (1.8kg without accessories)

£248.29 Part No. 744546

Karcher Petrol Cold Water Pressure Washer HD 6/15 G



- Equipment:
- Trigger gun, EASY!Force
 - High-pressure hose: 10m
 - Spray lance: 840 mm
 - Power nozzle
 - Flow rate (l/h): 600
 - Max. pressure (bar): 200
 - Engine type: G200FA/ Petrol

£1218.89 Part No. 744510

Karcher Window Vac WV6 Plus



- Includes accessory pack
- 280mm and 170mm vacuum nozzles
- Dirty water container capacity: 150ml
- Battery charging time: 170 minutes
- Battery running time: 100 minutes

£136.62 Part No. 744542

Karcher Manual Push Sweeper KM 70/15 C



- Drive: Manual
- Max. area performance (m²/h): 2800
- Working width (mm): 480
- Working width with 1 side brush (mm): 700
- Container capacity gross/net (l): 42 / 20

£441.94 Part No. 744544

Karcher Floor Scrubber Dryer BR 30/4 C



- Working width, brush: 300mm
- Working width, vacuum: 300mm
- Motor rating: 820W
- Fresh / waste water tank: 4L / 4L
- Brush contact pressure: 100 g/cm²
- Brush rotation speed: 1450RPM
- Max. area performance: 200m²/h
- Practical area performance: 150 m²/h

£1195.13 Part No. 744558

Karcher Floor Scrubber Dryer BD 43/25 BP



- Working width, brush: 430mm
- Working width, vacuum: 850mm
- Motor rating: 1100W
- Battery: 24V
- Fresh / waste water tank : 25L / 25L

POA Part No. 744560

Karcher Cleaning Chemicals



Part No.	Description	Qty	Price
744562	2.5L PressurePro Active Cleaner	1	£25.20
744564	2.5L FloorPro Deep Cleaner	1	£17.35

Pump Sprayers



Part No.	Description	Qty	Price
1 B081869	1.25L (Dissolving)	1	£22.11
2 B081870	1.25L (Cleaning)	1	£22.11
3 B135128	1L (Brake Cleaner)	1	£22.11

1.5L Chemical Resistant Pump Up Plastic Sprayer



£15.46
Part No. CE061

Plastic Funnels with Flexible Spouts

- Detachable flexible spout
- Includes filter
- Resistant to vehicle specific fluids



Part No.	Size	Qty	Price
1 B024245	6"	1	£5.81
2 510212	9"	1	£6.72

10L Plastic Watering Cans



- Detachable sprinkle rose

Part No.	Colour	Qty	Price
700060	Green	1	£9.24
700230	Yellow	1	£9.24
700232	Blue	1	£9.24
700234	Red	1	£9.24
700236	Pink	1	£9.24

600ml Trigger Sprayer Bottles



Part No.	Description	Qty	Price
CE018-B	Trigger Head	1	£0.73
CE008-N	Natural Bottle	1	£0.69
CE008-B	Blue Bottle	1	£0.69
CE008-G	Green Bottle	1	£0.69
CE000	Natural with Trigger	1	£1.44

5L Container Pump (30ml Dosage)



£3.48
Part No. CE130

10L Pressure Sprayer



£46.70
Part No. CE101

Oil S squirt Cans



- Steel pump
- Comes with flexi and rigid spouts

Part No.	Size	Qty	Price
510236	220ml	1	£3.59
510228	500ml	1	£4.73

Plastic Oil Measure



Part No.	Description	Qty	Price
510215	3L	1	£9.67
510220	5L	1	£16.32

AdBlue Gravity Feed Kits



Part No.	Description	Qty	Price
1 734906	PVC 3m for Bottom Outlet IBC Units	1	£77.52
2 734908	EPDM Rubber Hose 3m for Bottom Outlet IBC Units	1	£146.51

Compact Electric Multi Fluid Pump



- Electrically operated pump for the dispensing of multiple fluids from 205 litre drums
- The pump comes complete with 2" to Trisure adaptor for easy fitting to AdBlue barrels
- Can be used with: Diesel, DEF/AdBlue, water, kerosene, anti-freeze, windshield washer fluid, mild detergents, agricultural chemicals & light oils

£206.25
Part No. 734920

AdBlue Lever Pump for 205L Drum complete with Adaptor & Dispensing Hose

- Lever action pump with a unique toggle mechanism: provides a very smooth pumping action
- Manufactured in polypropylene and includes a 2" bung adaptor with a lockable nut that allows placing the pump in its optimal position for an easier lever action
- Pump delivery per stroke: 500cc



£60.11
Part No. 734904

Barrel Pump - Rotary



- Robust tool pumps oil and diesel using 3/4 and 1" Dr fittings
- Pumps oil and diesel
- Extending tubes for reaching the bottom of the barrel
- Wind up pump action
- Robust metal construction

£59.51
Part No. BT003215

Pump Action Syphon Barrel Pump



- Syphon any non-corrosive fluid including petrol & diesel
- Deep fixed tube for accurate filling (900mm)
- Flexi hose for extracting
- Pump action

£16.94
Part No. BT002709

95L Samoa Anti-freeze Recovery Unit



- Low level waste oil drainer - 95 litres
- Equipped with a DF50 diaphragm pump
- Allows draining the antifreeze when a pit or lift is not available
- Thanks to the diaphragm pump and the delivery gun it is possible to reuse the antifreeze

£1275.32
Part No. 734922

Mobile Waste Oil Collection Units



- Discharge is done through a 1:1 pressure ratio pneumatic piston pump attached to the back of the unit reservoir and 1.5m hose with a hydraulic type coupler

Part No.	Description	Qty	Price
1 734268	70L	1	£927.70
2 734910	100L	1	£808.19

Diesel Transfer Pump Kits



- Portable transfer kit with 24 or 12 VDC Polux Series pump, delivery hose, nozzle, meter, fittings and suction kit depending on the model

Part No.	Description	Qty	Price
1 734912	12V	1	£340.76
2 734914	24V	1	£342.95

2pc Non-Spark Plastic Shovel

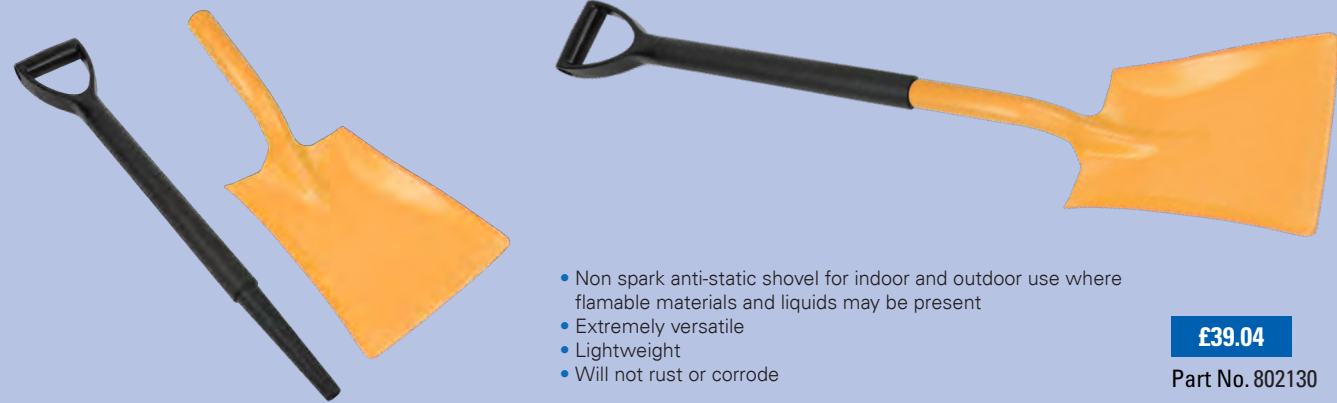

- Non spark anti-static shovel for indoor and outdoor use where flammable materials and liquids may be present
- Extremely versatile
- Lightweight
- Will not rust or corrode

£39.04

Part No. 802130

Drum Top Mats



380mm x 40m Multi-Format Absorbent Roll



- Designed to absorb and retain all oils and fuels

£59.88

Part No. 800891

48 x 39cm Grey Maintenance Oil and Water Pads



- Pack of 100
- Designed to absorb and retain all oils, fuels and water

£88.90

Part No. 800965

50 x 40cm White Oil Only Pads



- Pack of 100
- Designed to absorb and retain oils & fuel

£45.87

Part No. 800835

1L Degreaser for Spillpod Duo Stations

- Pack of 2
- A versatile cleaner containing alkalis, surfactants and special water conditioning additives to provide superior cleaning results



£16.50

Part No. 802046

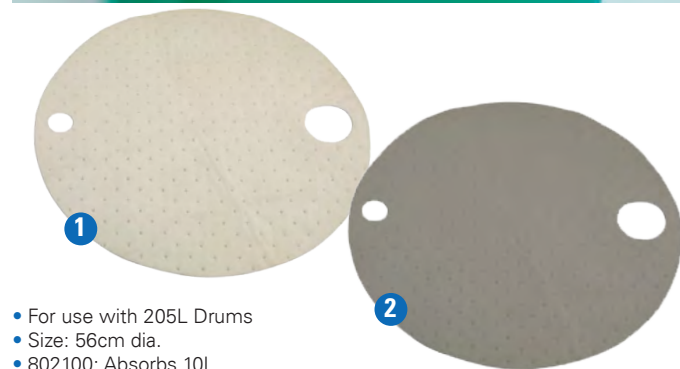

- For use with 205L Drums
- Size: 56cm dia.
- 802100: Absorbs 10L
- 802102: Absorbs 8L

Part No.	Description	Qty	Price
1	802100 Oil Absorbent Drum Top Mats	10	£25.86
2	802102 General Purpose Drum Top Mats	5	£12.94

Heavyweight Drain Covers

- Protect drains from hazardous spills & leaks
- Heavyweight material stops liquids seeping underneath
- Resistant to water, oil and most chemicals
- Durable, flexible and contour-hugging



Part No.	Description	Qty	Price
802104	610mm x 610mm	1	£104.26
802106	910mm x 910mm	1	£208.75

4 x 200L Drum Waste Oil Spill Tray

- Low profile spillpallet ideal for use under waste collection drums and containers
- Reduces risk of floor contamination
- Improves safety
- Removable drum grid
- Holds up to 4 x 200L drums
- Ideal 'quarantine' point for damaged drums
- Absorbency/capacity: 120 litres
- Dimensions: 120 x 120 x 12cm



£112.78

Part No. 802119

Yellow IBC Pallets



- Bundled storage for IBC's
- 100% recyclable weatherproof PE construction
- Compatible with most forklifts and pallet trucks
- Sumps are compliant with oil storage regulations
- Tough grid-deck for safe and easy location of IBC

Part No.	Description	Qty	Price
1	802108 Single Pallet 1100L	1	£997.43
2	802110 Raincover for Single Pallet	1	£241.54
3	802112 Yellow Double Pallet 1130L	1	£1,156.95
4	802114 Raincover for Double Pallet	1	£283.80

250L Yellow Drum Pallets

- Safe bundled storage for 200L drums and smaller containers
- Removable grid-decks for easy cleaning
- Weatherproof PE construction (100% recyclable)
- Compliant with oil storage regulations
- Compatible with most forklifts and pallet truck



Part No.	Description	Qty	Price
802116	2 Drum Pallet	1	£234.97
802118	4 Drum Pallet	1	£267.73

Spill Kit Selection Guide

General Purpose

Ideal for:

- Coolant
- Antifreeze
- Oil
- Water
- Weak chemicals
- Solvents

Oil & Fuel

Ideal for:

- Hydraulic oil
- Engine oil
- Lubricating oil
- Solvents

Will not absorb water

Chemicals

Ideal for:

- Acids
- Alkalis
- Strong chemicals
- Solvents

Not for use on oxidisers

50L General Purpose Spill Kit Shoulder Bag



Part No.	Description	Qty	Price
802080	General Purpose Spill Kit	1	£74.82
802082	General Purpose Refill Pack	1	£44.19

50L Oil & Fuel Spill Kit Shoulder Bag



Part No.	Description	Qty	Price
802084	Oil & Fuel Spill Kit	1	£74.82
802086	Oil & Fuel Refill Pack	1	£44.19

50L Chemical Spill Kit Shoulder Bag



Part No.	Description	Qty	Price
802088	Chemical Spill Kit	1	£86.60
802090	Chemical Refill Pack	1	£55.97

General Purpose Spillpod Duo



Part No.	Description	Qty	Price
802028	Filled General Spillpod Duo	1	£202.27
802030	General Purpose Refill Pack*	1	£60.30

Oil & Fuel Spillpod Duo



Part No.	Description	Qty	Price
802034	Filled Oil & Fuel Spillpod Duo	1	£202.27
802036	Oil & Fuel Refill Pack*	1	£59.22

Chemical Spillpod Duo



Part No.	Description	Qty	Price
802040	Filled Chemical Spillpod Duo	1	£202.27
802042	Chemical Refill Pack*	1	£64.33

*A refill pack includes 75 pads, 1 roll, 1 degreaser & 1 box of gloves

General Purpose Spill Kits in Clip-top Bags



Part No.	Description	Qty	Price
802050	15L Bag	1	£16.34
800924	20L Bag	1	£21.21
802062	30L Bag	1	£29.46
802074	40L Bag	1	£36.52

Oil & Fuel Spill Kits in Clip-top Bags



Part No.	Description	Qty	Price
802052	15L Bag	1	£16.34
800926	20L Bag	1	£21.21
802064	30L Bag	1	£29.46
802076	40L Bag	1	£36.52

Chemical Spill Kits in Clip-top Bags



Part No.	Description	Qty	Price
802054	15L Bag	1	£19.83
800928	20L Bag	1	£29.46
802066	30L Bag	1	£35.34
802078	40L Bag	1	£45.87

General Purpose Spill Kits in Break Packs



Part No.	Description	Qty	Price
802056	30L Break Pack	1	£17.50
802068	40L Break Pack	1	£23.33

Oil & Fuel Spill Kits in Break Packs



Part No.	Description	Qty	Price
802058	30L Break Pack	1	£17.50
802070	40L Break Pack	1	£23.33

Chemical Spill Kits in Break Packs



Part No.	Description	Qty	Price
802060	30L Break Pack	1	£19.83
802072	40L Break Pack	1	£28.00

Single Application Hygienic Biohazard Kit

- For the safe disinfecting of body fluid spills in the workplace, such as blood or vomit
- Our single application hygienic biohazard kit provides everything you need to confidently ensure a clean environment

£15.38

Part No. 700701



Fire Extinguisher Signs

- Environmentally friendly material
- Manufactured to comply with the latest legislation in BS EN ISO 7010
- Rigid
- Dimensions: 300 x 100mm



Part No.	Description	Qty	Price
1	590190 CO2 Extinguisher	1	£6.69
2	590200 Water Extinguisher	1	£6.69

Part No.	Description	Qty	Price
3	590210 Dry Powder Extinguisher	1	£6.69
4	590220 Foam Extinguisher	1	£6.69

Fire Alarm Sign

- Rigid
- Dimensions: 100 x 200mm

£6.69

Part No. 590170



Fire Action Notice Sign



- Rigid
- Dimensions: 210 x 148mm

£7.74

Part No. 590290

Dry Powder Fire Extinguishers

- Multi-purpose unit capable of extinguishing fires fuelled by: 1. Class A, combustible materials: paper, wood and textiles 2. Class B, flammable liquids: petrol 3. Class C, flammable gases: methane, acetylene and propane
- The low minimum operating temperature makes them suitable for all-year-round external situations and has CE-marked brass valve assemblies.
- It has a fire rating of 13A 70B C
- Supplied with wall bracket



Part No.	Size	Qty	Price
EB021	1kg	1	£22.40
EB022	2kg	1	£27.42

Fire Blankets



- Ideal for use in caravans, schools, hospitals, laboratories, factories and offices
- BS EN 1869:1997
- Supplied in a red moulded plastic rigid case

Part No.	Size	Qty	Price
EB050	1.1 x 1.1m	1	£30.14
EB051	1.2 x 1.2m	1	£36.55

Fire Safety A4 Document Holder



- Features a durable nylon strap with eyelet, so you can hang it on any wall, cabinet or hard surface easily. The law requires that your documents are clearly displayed and accessible

£30.88

Part No. 810650

SLEEPSAFE CO Alarm



- Complete with 9v battery
- Reliable, compact & robust
- Powerful 85 dB speaker
- Certified to EN 50291:2001
- 6 year guarantee

£41.14

Part No. VANDET5

SLEEPSAFE Smoke Alarm



- Complete with 9v battery
- Reliable, compact & robust
- Powerful 85 dB speaker
- Certified to EN 14604:2005

£10.55

Part No. VANDET6

Fog Horn



- Environmentally friendly (GWP - of 1, the lowest on the market today)
- Maximum Noise Level:120dB

£15.47

Part No. 117500

Fire Safety Log Book A5



- Ensures your company's fire procedures are easily accessible

£19.00

Part No. 810660

Eye Wash & Wound Station with 10 x 20ml Pods & Bracket

- For cleansing wounds to reduce risk of infection
- Slimline neck twist off tops are ready to use in seconds and provide improved directional accuracy
- 20ml saline pods treat both eyes and wounds
- Fixes to the wall for easy access
- It also comes with its own shatterproof mirror and simple instructions for treating minor eye injuries



Part No.	Description	Qty	Price
EA158	Eye Wash Station	1	£19.78
EA160	Eye Wash Refills	1	£7.32

PGB First Aid Kits with Bracket

- For use in the workplace and home
- Kit provides British Standard components and contents which can assist in providing adequate first aid provision based upon each company's risk assessment
- BS 8599-1:2019 compliant



Contents	Small	Medium	Large
12 x 12cm Medium Dressing	2	4	6
18 x 18cm Large Dressing	2	3	4
Triangular Bandage	2	3	4
Eye Pad & Bandage	2	3	4
Wash-proof Plasters	40	60	100
Cleansing Wipes (Sterile)	20	30	40
2.5cm x 5m Microporous Tape	1	2	3
Nitrile Gloves (Pair)	6	9	12
3.5 x 3.5cm Finger Dressing	2	3	4
Revive Aid (Resuscitation Device)	1	1	2
Thermal Blanket	1	2	3
10 x 10cm Burn Dressing	1	2	2
Tuff Cut Scissors	1	1	1
7.5 x 4.5cm Conforming Bandage	1	2	2
Part Number	350010	350012	350014
Price	£24.16	£30.53	£44.43

Refills

Part No.	Description	Qty	Price
350016	Small First Aid Kit Refill for 350010	1	£15.26
350018	Medium Refill First Aid Kit Refill for 350012	1	£24.67
350020	Large Refill First Aid Kit Refill for 350014	1	£31.38

Eye Wash Station

- Highly visible eye and wound wash wall plate, for instant minor eye injuries
- Holds two 500ml eye and wound wash bottles
- It also comes with its own shatterproof mirror and simple instructions for treating minor eye injuries
- The twist off top makes it ready for use in seconds



Part No.	Description	Qty	Price
EA150	Eye Wash Station Deluxe	1	£18.21
EA149	Refill (2x 500ml Eye Solution & 2x Wound Dressings)	1	£7.73
EA152	500ml Eye Irrigation Solution	1	£3.43

Plaster Dispenser & Plasters



Part No.	Description	Qty	Price
B180694	Plaster Dispenser with 90 Plasters	1	£19.81
B180695	45pc Waterproof Plasters	1	£4.96
B180696	45pc Fabric Plasters (72 x 25mm)	1	£5.73
B180697	30pc Fabric Plasters - Extra Long (120 x 20mm)	1	£5.39

PCV First Aid Kit with Bracket

- For public service or commercial vehicles
- Also suitable for general use and domestic vehicles
- Perfect for keeping handy in vehicles in case of emergency (Required by law - Road Traffic Act 1986: all minibuses and coaches should carry a first aid kit suitable for treating minor first aid injuries)



Contents	Qty
Guidance Leaflet Provides Brief First Aid Guidelines	1
Assorted Plasters	24
Eye Pad Dressings	2
Triangular Bandages	2
Conforming Bandage	1
Safety Pins (Pack of 6)	2
Ambulance Dressing No2	3
Saline Cleansing Wipes (Individually wrapped)	10
Gloves (Pair)	1
Scissors	1

£19.13

Part No. 350002

Disinfectant Wipes



Part No.	Description	Qty	Price
310752	Surface Wipes Tub	1000	£23.46
310782	Hand & Surface - Pack of 40	16	£29.68

COVID-19 Kit incl. Sanitiser Masks Vinyl Gloves and Wipes



£20.14
Part No. 310780

500ml Alcohol Gel Hand Sanitiser and Wall Bracket



Part No.	Description	Qty	Price
310753	Sanitiser	1	£5.95
310768	Self adhesive Bracket	1	£5.89

Anti-Bacterial Aerosols



Part No.	Description	Qty	Price
1	310762 100ml Vehicle Sanitizer Fogger	1	£5.39
2	310760 200ml Room Sanitizer Fogger	1	£8.48
3	310758 200ml Air & Surface Sanitizer	1	£7.94
4	310756 200ml Hand Sanitizer Spray	1	£7.12
5	310766 500ml 70percent Alcohol Surface Spray	1	£8.63

400w Auto Expel Misting Machine



- Biocidal formula proven to kill Enveloped-Viruses such as Coronavirus and MRSA
- Suitable for use on all surfaces including leather and cloth
- Dry mist system - the mist machine heats up the sanitising liquid and produces a fine dry mist. No wet residue left on the surfaces
- Easy to use - vehicle will be free from bacteria and viruses within 30 minutes. Run the mist machine for just five minutes and allow the dry mist to settle for 25 minutes
- Can sanitise the vehicles air-conditioning system - simply switch on the recycle air to pass the mist through the air-conditioning system for a complete sanitised vehicle
- Eliminates all foul odours
- Leaves a fresh scent in the vehicle
- ROHS approved mist machine

£136.62
Part No. 310776

Sanitising Liquid for Auto Expel Misting Machine



- Liquid is specially formulated to kill germs, viruses and bacteria from your cabin with the use of an Auto Expel Mist Machine
- All scents available in 1L & 5L

Part No.	Description	Qty	Price
310771	1L Sanitiser Liquid - Lemon Fresh	1	£17.77
310777	5L Sanitiser Liquid - Lemon Fresh	1	£59.39
310772	1L Sanitiser Liquid - Showroom Fresh	1	£17.77
310778	5L Sanitiser Liquid - Showroom Fresh	1	£59.39
310773	1L Sanitiser Liquid - Forest Cherry	1	£17.77
310779	5L Sanitiser Liquid - Forest Cherry	1	£59.39

Skin Care Station
A robust, lightweight board offering a convenient solution to your skin care needs.

- 3 simple skin care steps
- Quality product
- Dermatologically tested
- Easy to install and maintain
- Great value
- Dimensions: 800 x 570mm

Contents

- 1L Hand Protection Cream
- 2L Standard Hand Cleaner
- 2L Premium Hand Cleaner
- 1L Hand Care Cream
- 4 Soft Bottle Dispensers
- Skin Care Station Wall Board

£200.77

Part No. B551581



Profi Clean 72 Wipes

- Cleans and nourishes hands
- Suitable for cleaning tools etc
- No water required
- Dermatologically tested
- Silicone free

£16.31

Part No. B142454



10L Hand Cleaner Paste

- Removes oil, grease, lubricant, dirt etc
- Does not clog drains
- Dermatologically tested
- Silicone free

£39.61

Part No. B132238



250ml Standard Hand Cleaner

- Removes oil, greases, lubricants, dirt etc
- Silicone and solvent free
- Dermatologically tested

£3.43

Part No. B362809



250ml Hand Protection Cream

- Prevents hazardous chemicals from penetrating the skin
- Reduces risk of allergies and rashes
- pH-neutral

£4.97

Part No. B240032



250ml Hand Care Cream

- Vitamin A increases the protection of the skin against UV
- pH-neutral
- Dermatologically tested
- Silicone-free

£6.28

Part No. B240034



Accessories for Hand Cleaner



Part No.	Description	Qty	Price
B55159	3L Wall Bracket	1	£10.52
B242700	3L Dispensing Pump	1	£11.84
B240314	1L/2L Soft Bottle Dispenser	1	£38.29

3L Hand Cleaner



Part No.	Description	Qty	Price
B362813	Standard	1	£16.16
B362811	Premium	1	£24.89

Step 1: Protection

1L Hand Protection Cream

- Protects skin from harmful substances: lubricants, diluted acids, alkalis, oils etc
- Non-greasy and easy to apply
- pH-neutral
- Dermatologically tested
- Silicone free

£15.81

Part No. B219324



Step 2: Cleaning

Standard

- Removes oil, grease, lubricant, dirt etc
- Economical
- Silicone and solvent free
- 100% natural raw material (corn cob powder): does not contain plastic micro beads

Premium

- Removes adhesives, varnishes, paints, resins, sealants, polyurethane etc
- Economical
- Silicone and solvent free
- 100% natural raw material (walnut shell powder): does not contain plastic micro beads



Part No.	Description	Qty	Price
1	B362807 2L Standard Hand Cleaner	1	£13.27
2	B410759 2L Hand Cleaner Lotion	1	£15.81
3	B362806 2L Premium Hand Cleaner	1	£19.90

Step 3: Care

1L Hand Care Cream

- Helps tired skin recover after work
- Lightly-greasy
- Contains natural a-bisabolol (chamomile) and Vitamin E
- Vitamin A protects against UV rays
- Dermatologically tested
- Silicone free

£19.36

Part No. B219323



Dispenser sold separately - Part No. B240314

5g Blue Nitrile Powder Free Gloves

- Ambidextrous
- Comfortable beaded cuff
- Latex free
- Excellent puncture resistance and strength
- Superior barrier protection over latex and vinyl
- Fully micro-textured for excellent wet and dry grip



Part No.	Size	Qty	Price
307000	S	100	£10.50
307001	M	100	£10.50
307002	L	100	£10.50
307003	XL	100	£10.50

7.5g Orange Nitrile Diamond Grip Powder Free Gloves

- Premium, textured, disposable glove packed in boxes of 100
- Offers excellent elasticity, puncture resistance and chemical resistance
- A great fit for automotive, industrial and food handling operations
- The additional diamond grip texture enables improved dexterity



Part No.	Size	Qty	Price
307010	S	100	£16.50
307011	M	100	£16.50
307012	L	100	£16.50
307013	XL	100	£16.50

Green Nitrile Powder Free Gloves

- Delivers strong grip in wet or dry conditions
- Highly versatile and suitable for many different uses
- Complaint to EN374



Part No.	Size	Qty	Price
304230	M	100	£20.83
304232	L	100	£20.83
304234	XL	100	£20.83

5g Black Nitrile Powder Free Gloves

- Excellent puncture and tear resistance
- Chemical resistance
- Maximum dexterity enables better performance in intricate tasks
- Powder-free
- Comfortable to ensure hand fatigue is reduced
- Good grip helping to ensure movement is completely unrestricted



Part No.	Size	Qty	Price
307005	S	100	£12.50
307006	M	100	£12.50
307007	L	100	£12.50
307008	XL	100	£12.50

Latex Gloves - Powder Free

- Liquid and dirt proof
- Disposable
- Very good fit



Part No.	Size	Qty	Price
304330	M	100	£10.68
304332	L	100	£10.68
304334	XL	100	£10.68

Latex Gloves - Pre Powdered

- Liquid and dirt proof
- Disposable
- Very good fit



Part No.	Size	Qty	Price
DG038-S	S	100	£5.76
DG038-M	M	100	£5.76
DG038-L	L	100	£5.76

Flexus Dry Gloves

- For activities involving oil, water, paint or similar substances, such as: oil change, car washing, engine overhaul, metalworking and construction
- Protects against liquids, oils and solvents
- Safe grip especially in greasy and wet conditions
- Abrasion and tear resistance

Part No.	Size	Qty	Price
B199715	S9	1	£5.02
B199716	S10	1	£5.02

Flexus Gloves

- Elastic lining with a micro-foam nitrile/PU coating
- Double coated palm for excellent wear resistance and superior grip
- Seamless ergonomic fit for comfort
- Good oil resistance
- Maximum breathability and water repellent coating

Part No.	Size	Qty	Price
B152824	S8	1	£3.38
B152825	S9	1	£3.38
B152826	S10	1	£3.38

Polyurethane Work Glove B-Grip

- High wearing comfort
- Seamless nylon gloves with polyurethane coating
- Excellent touch sensitivity
- Suitable for precision work
- Thin finely knitted fabric and breathable PU coating

Part No.	Size	Qty	Price
B170342	S8	1	£0.98
B170343	S9	1	£0.98
B170344	S10	1	£0.98

Buy 50+ £0.64

B-Grip Gloves

- For repair, maintenance, assembly and manufacturing work
- High quality natural latex coating
- Breathable fine knit nylon
- Good (wet or dry) grip due to textured palm
- Protects from moisture and colder temperatures
- CE approved

Part No.	Size	Qty	Price
B040875	S8	1	£1.51
B040876	S9	1	£1.51
B040877	S10	1	£1.51

HyFlex Ultralite Knitwrist Gloves

- Suit a wide range of lightweight applications in dry or slightly oily environments, it is ideal for workers who need a high level of fit, touch and precision

Part No.	Size	Qty	Price
662722	S8	1	£4.06
662723	S9	1	£4.06
662724	S10	1	£4.06
662725	S11	1	£4.06

Perfect Fit Gloves (Anti-Slash)

- Ideal for use in automotive, construction & utility, engineering and manufacturing, warehousing, transport and logistics
- Good protection against abrasion & tear hazards
- EN388 (3131)
- Seamless knitted liner for extra comfort

Part No.	Size	Qty	Price
9-82367	S9	1	£1.33
9-82368	S10	1	£1.33

Size 10 Cowhide Rigger Leather Gloves

- Thumb and index finger completely made of leather
- Leather wrist guard and fingertips
- Soft inner lining
- Highly breathable
- EN420 and EN388
- Protection Category: 2

£2.92

Part No. B243415

S9 Hy-Flex Poly. Palm Coated Glove (pr)

- Used in automotive, machinery, & metal fabrication
- Designed for light and delicate applications in dry environments that require maximal levels of dexterity
- They offer comfortable & exact handling of small objects
- Palm-dipped style for added protection

£2.97

Part No. 510590



Polyester Latex Palm Coated Gloves

- Embossed latex coating for great grip in wet and dry conditions
- EN407 heat resistant for contact heat to 250°C, threshold time: greater than or equal to 15 seconds

Part No.	Size	Qty	Price
510900	S7	1	£3.84
510902	S8	1	£3.84
510904	S9	1	£3.84
510906	S10	1	£3.84
510908	S11	1	£3.84

Buy 6+
£3.29
Buy 10+
£1.78



Yellow Hi-Vis Knitwrist Gloves

- Specially designed for use in cold conditions
- The crinkled latex finish offers excellent grip
- Warm acrylic 7 gauge liner offers protection against cold hazards in extreme conditions
- CE certified
- Palm dipped to increase dexterity

Part No.	Size	Qty	Price
662712	S9	1	£4.15
662713	S10	1	£4.15



Grey/Black Dermiflex Ultra Gloves

- Protects against oil in warm, humid conditions
- 3/4 dipped for increased protection
- Nitrile foam coating for excellent grip in wet and dry conditions
- CE certified
- Maximum EN level 4 abrasion

Part No.	Size	Qty	Price
107030	S9	1	£2.28
107032	S10	1	£2.28



Reflex-T Palm Coated Orange Gloves

- Seamless knitted polycotton glove with a crinkle latex palm coating
- Protects from mechanical hazards
- Excellent grip and is highly elastic
- Breathable and comfortable reducing hand fatigue

Part No.	Size	Qty	Price
510539	S8	1	£2.28
510540	S9	1	£2.28
510541	S10	1	£2.28



Red PVC Gauntlets Size 10

- Ideal for agriculture/green, heavy industry & biological chemical markets
- PVC on cotton jersey lining
- EN420:2003 General requirements
- EN388:2003

Part No.	Size	Qty	Price
DF056	11" cuff	1	£1.82
DF057	14" cuff	1	£2.41



S9 Red PVC Knitted Wrist

- Red PVC full coating on a cotton liner with a knitted wrist
- Multi-purpose glove for general handling in oily or wet conditions
- Ribbed cuff
- PVC very resistant to chemicals
- Very good abrasion resistance and very long life service

£1.52
Part No. DF055

Size 10 (XL) Good Quality Driver Lined Gloves



- Soft grain leather
- Gun pattern design
- Half elastication to back of cuff
- Fleece lined
- EN388: 2016
Level 3 - Abrasion
Level X - Cut Resistance
Level 4 - Tear Resistance
Level 4 - Puncture
Level B - ISO 13997 Cut Resistance

£6.83
Part No. 510702

MOLDEX 2405 EN149 Dust/Mist/Fume Mask FFP2

- Pack of 20
- Proven shape and durable FFP2 Mask
- DuraMesh®: strong and durable structure, keeps the mask in shape
- ActivForm®: no nose clip needed
- Loop strap for quick, simple and safe on and off
- Tested and certified to EN149:2001+A1:2009



£56.66
Part No. 510615

FFP1 Dust Mask



- Pack of 20
- Protects against (dust) particles from paper fibre, plaster, limestone, marble and silicone
- CE approved and complies with EN 149: 2001

£27.83
Part No. B519394

FFP2 Disposable Half Face Masks with Valve



- Pack of 10
- Non woven synthetic fibre disposable masks
- Nose clip for adjustment
- Foam edge under nose clip
- High performance exhalation valve
- DOLOMIA optional test for longer continuous wear time

£13.88
Part No. 816476

3M 06941/4251 Maintenance Free Half Mask



- Maintenance free, low profile, comfortable design integrated filters and high efficiency exhalation valve
- Conforms to: EN405 2001. CE Marked. FFA1P2RD

£39.33
Part No. 510311

Medium Half Mask Body



- Easy maintenance and cleaning without tools
- With EasyLock® filter system: easy handling

Part No.	Description	Qty	Price
510634	Mask	1	£17.86
510619	Filters (pair)	1	£9.87

Moldex 2400 Dust/Mist/Fume Mask FFP2



- Pack of 20
- DuraMesh®: strong and durable structure, keeps the masks shape
- ActivForm®: no nose clip needed
- Loop strap for quick, simple and safe on and off
- EN 149:2001+A1:2009

£47.77
Part No. 510610

3-Ply Face Mask (Medical) Box of 50



- Nonwoven 3-Ply Disposable Medical Mask with ear loops
- For medical use, tested to EN14683:2019 performance standard

£22.95
Part No. 810600

Face Coverings



Part No.	Description	Qty	Price
BT035369	Splash Shield	1	£5.49
816485	Navy Neck Tube	1	£4.74

Are you choosing the correct mask protection level for your environment or application?

The table below explains the levels of protection offered by different levels of FFP (Filtering Face Pieces).

	FFP1	FFP2	FFP3
Protection Level	APF4	APF10	APF20
Typical Uses	Low level fine dust/oil or water based mists (hand sanding, drilling and cutting)	Moderate level fine dust/oil or water based mists (plastering, cement, sanding and wood dust)	Higher level fine dust/oil or water based mists (hazardous powders, biological agents and fibres)

COVERALLS

PERSONAL PROTECTION

Eka55 Coveralls



- 55gsm micro porous fabric
- Cat III type 5/6
- High protection to liquid chemical splashes
- Elasticated back, hood, cuffs, ankles and adhesive zip flap

Part No.	Description	Qty	Price
900702	M	1	£4.94
900704	L	1	£4.94
900706	XL	1	£4.94

White PU Non-Slip Overshoes



- Pack of 20
- 70gsm anti-slip sole
- Strong and resistant to chemical splash and dust

£15.64

Part No. 900814

Cool67 Coveralls



- 67gsm micro porous laminated fabric
- 50gsm SMS breathable back panel
- Cat III type 5/6
- Protects against high chemical splash and is a hazardous particle barrier
- 3 piece hood, knitted cuffs, elasticated ankles, two way zip and adhesive zip flap

Part No.	Description	Qty	Price
900714	M	1	£6.08
900716	L	1	£6.08
900718	XL	1	£6.08

Disposable Shoe Covers Blue



- Pack of 100
- Suitable for food industry
- 16"

£7.38

Part No. 990122

Heavy Duty Double Gel Knee Pads - Pair



- Double gel: maximum cushioning for added comfort and manoeuvrability
- Twin hook-and-loop straps stop knee pads from slipping

£23.13

Part No. SSP63

Knee Pads for Work Trousers



£7.47

Part No. 910630

Large Shield Polythene Diesel Gloves



- Flexible material for improved feel
- PPE CAT I EN420 Food Contact EC1935/2004
- Pack of 1000

£8.27

Part No. 510424

Hard Hats



- For use in the construction and civil engineering industries
- UV-resistant high density polyethylene (HDPE)
- Low density (LDPE) polyethylene cradle with 8 fixing points
- Manual adjustment: head sizes 53/63cm
- Electrical Insulation up to 1000 V.AC or 1500 V.DC
- Standard holes for accessories
- Anchorage for chin straps with 2 or 4 points
- Sweat band

Part No.	Colour	Qty	Price	Part No.	Colour	Qty	Price	Part No.	Colour	Qty	Price
765480	Blue	1	£6.33	765486	Grey	1	£6.33	765490	Red	1	£6.33
765482	White	1	£6.33	765488	Orange	1	£6.33	765492	Green	1	£6.33
765484	Yellow	1	£6.33								

Ear Defenders SNR 30dB

- CE tested and complies with EN 352-1



£14.86

Part No. B199821

Ear Plugs SNR 32dB

- Pack of 250
- CE tested and complies with EN 352-2



£40.26

Part No. B121210

Bump Caps



Part No.	Colour	Qty	Price
765496	Hi-Vis	1	£10.44
765475	Navy	1	£16.01

Reduced Peak Bump Caps



Part No.	Colour	Qty	Price
765494	Navy	1	£10.44
765476	Red	1	£18.13

500ml Bolle Anti Fog Spray

- Specially developed to combat the appearance of fogging, the B-Clean anti-fog line guarantees your eye protection will be used to its best



£41.57

Part No. 810620

Eye Protection



Part No.	Description	Qty	Price
1	B160179 Clear Protective Spectacles	1	£2.38
2	SA108-C Brava Safety Spectacle Clear	1	£3.76
3	B087568 Clear Safety Glasses	1	£3.77
4	910631 Bolle Slam Clear Safety Glasses	1	£7.38
5	910632 FUJI 2 Gradient Glasses	1	£11.59
6	910634 Delta Plus FUJI Clear Glasses	1	£12.52
7	816428 Standard Clear Goggles	1	£3.51
8	B61704 Safety Goggles EN166	1	£12.33
9	B370449 Combi-Fit Glasses with Cord	1	£8.26

Honey Goodyear Welted Safety Boots



£62.99

Part No. LT37 (04-13)

Tan Waterproof Pull on Rigger Boots



Part No.	Material	Qty	Price
1 LT18 (03-15)	Leather	1	£62.08
2 LT41 (04-12)	PVC	1	£50.18

CAT Parker Dark Beige Safety Boots



£138.77

Part No. LT58 (06-12)

Waterproof Pull on Ribbed Safety Wellingtons



Part No.	Colour	Qty	Price
LT11 (04-13)	Black	1	£29.52
LT43 (04-13)	Green	1	£29.52

Black Dual Density Pull on Safety Dealer Boot



£46.35

Part No. LT16 (03-15)

Black Waterproof Lace Up Hiker Safety Boots



£85.72

Part No. LT31 (03-15)

Black Metatarsal Protection Waterproof Lace up Safety Boots



£114.47

Part No. LT42 (06-13)

Black Waterproof Lace Up Safety Boots



£59.55

Part No. LT27 (03-13)

Black Moorfoot Internal Metatarsal Safety Boots



£68.51

Part No. LT32 (06-12)

Black Metal Free Waterproof Lace Up Safety Trainers



£78.52

Part No. LT29 (06-12)

Black Lightweight Metal Free Lace up Safety Trainer



£50.48

Part No. LT33 (02-13)

Black Ladies Heat Resistant Lace up Safety Trainers



£60.63

Part No. LT35 (03-09)

Footwear Key

Metal Free	Waterproof	Composite Cap	Anti-Static
Water Resistant	Midsole	Composite Midsole	Heat Resistant

Please Note:
Part numbers are first 4 digits followed by size
e.g. LT32(06-12), Size 7 would be LT3207, Size 10 would be LT3210

2-Tone Executive Vests

- CE certified
- Reflective tape for increased visibility
- Contrast panels for protection against dirt
- 7 pockets for ample storage



Part No.	Size	Qty	Price
107019	M	1	£8.49
106979	L	1	£8.49
107020	XL	1	£8.49

Reversible Bodywarmers

- CE certified
- 4 pockets
- Mobile phone compartment on quilted side
- Conforms to EN ISO 20471



Part No.	Size	Qty	Price
809049	S	1	£22.72
809050	M	1	£22.72
809052	L	1	£22.72
809054	XL	1	£22.72
809055	2XL	1	£22.72
809057	3XL	1	£22.72

Hooded Sweatshirts

- CE certified
- Durable fabric
- Generous pockets
- Adjustable hood



Part No.	Size	Qty	Price
769000	S	1	£26.28
769001	M	1	£26.28
769003	L	1	£26.28
769004	XL	1	£26.28
769005	2XL	1	£26.28
769006	3XL	1	£26.28

Hi-Vis Yellow/ Navy T-Shirts



- Moisture wicking fabric helping to keep the body warm, cool and dry
- 35+ UPF rated fabric to block 97% of UV rays
- 1 pocket for secure storage
- Crew neck
- Side vents for added comfort
- Designed with a comfort fit
- Complies with EN ISO 20471 standard

Part No.	Size	Qty	Price
765644	S	1	£15.43
765646	M	1	£15.43
765648	L	1	£15.43
765650	XL	1	£15.43
765652	2XL	1	£15.43
765654	3XL	1	£15.43

Hi-Vis Jackets



- Quilted lining
- Conforms to EN ISO 20471 and EN343

Part No.	Size	Qty	Price
765343	M	1	£24.29
765347	L	1	£24.29
765349	XL	1	£24.29

Vests

- Velcro fastening
- CE certified
- Reflective tape for increased visibility
- Lightweight
- EN ISO 20471



Yellow

Part No.	Size	Qty	Price
DB505-M/100	M	1	£2.91
DB505-L/100	L	1	£2.91
DB505-XL/100	XL	1	£2.91
DB505-XXL/100	2XL	1	£2.91
DB505-XXXL/100	3XL	1	£2.91

Orange

Part No.	Size	Qty	Price
DB506-S	S	1	£2.91
DB506-M	M	1	£2.91
DB506-L	L	1	£2.91
DB506-XL/100	XL	1	£2.91
DB506-XXL/100	2XL	1	£2.91
DB506-XXXL/100	3XL	1	£2.91

2 Tone Hi-Vis Jackets



- Quilted lining
- Conforms to EN ISO 20471 and EN343

Part No.	Size	Qty	Price
765420	S	1	£35.09
765424	M	1	£35.09
765425	L	1	£35.09
765426	XL	1	£35.09

Sweatshirts



- Stylish unisex design for multi functional use
- 40+ UPF rated fabric to block 98% of UV rays
- Raglan sleeves for a comfort fit

- Crew neck
- Ideal for corporate wear and custom finishes
- Twin-stitched seams for extra durability

Black

Part No.	Size	Qty	Price
765548	XS	1	£11.96
765550	S	1	£11.96
765552	M	1	£11.96
765554	L	1	£11.96
765556	XL	1	£11.96
765558	2XL	1	£11.96
765560	3XL	1	£11.96
765562	4XL	1	£11.96

Navy

Part No.	Size	Qty	Price
765564	XS	1	£11.96
765566	S	1	£11.96
765568	M	1	£11.96
765570	L	1	£11.96
765572	XL	1	£11.96
765574	2XL	1	£11.96
765576	3XL	1	£11.96
765578	4XL	1	£11.96
765580	5XL	1	£11.96

Hooded Sweatshirts



- Kangaroo pocket for ample storage
- Ribbed cuffs and hem for warmth and comfort
- Hood for added protection against the elements

- Knitted fabric with brushed backing
- Generous fit for wearer comfort
- 40+ UPF rated fabric to block 98% of UV rays

Black

Part No.	Size	Qty	Price
765582	S	1	£19.00
765584	M	1	£19.00
765586	L	1	£19.00
765588	XL	1	£19.00
765590	2XL	1	£19.00
765592	3XL	1	£19.00

Navy

Part No.	Size	Qty	Price
765594	S	1	£19.00
765596	M	1	£19.00
765598	L	1	£19.00
765600	XL	1	£19.00
765602	2XL	1	£19.00
765604	3XL	1	£19.00

Mens Corporate Shell Jackets



- Waterproof and breathable with taped seams to prevent water penetration
- 3 zipped pockets for ample storage
- Internal chest pocket

- Storm flap front to protect against the elements
- Front zip opening for easy access
- Pack away hood
- Hook and loop cuffs for a secure fit

Black

Part No.	Size	Qty	Price
765524	XS	1	£34.44
765526	S	1	£34.44
765528	M	1	£34.44
765530	L	1	£34.44
765532	XL	1	£34.44
765534	2XL	1	£34.44

Navy

Part No.	Size	Qty	Price
765536	XS	1	£34.44
765538	S	1	£34.44
765540	M	1	£34.44
765542	L	1	£34.44
765544	XL	1	£34.44
765546	2XL	1	£34.44

Ladies Corporate Shell Jackets



- Waterproof and breathable with taped seams to prevent water penetration
- 3 zipped pockets for ample storage
- Internal chest pocket

- Storm flap front to protect against the elements
- Front zip opening for easy access
- Pack away hood
- Hook and loop cuffs for a secure fit

Black

Part No.	Size	Qty	Price
765500	XS	1	£34.44
765502	S	1	£34.44
765504	M	1	£34.44
765506	L	1	£34.44
765508	XL	1	£34.44
765510	2XL	1	£34.44

Navy

Part No.	Size	Qty	Price
765512	XS	1	£34.44
765514	S	1	£34.44
765516	M	1	£34.44
765518	L	1	£34.44
765520	XL	1	£34.44
765522	2XL	1	£34.44

Warsaw Black and Red Bib and Brace



- This style has a host of winning features such as multiple pockets and back elastic for ease of movement. The contemporary fit and stylish design creates a modern garment suitable for a variety of jobs
- Phone pocket
- Sleeve pocket
- Hook and loop cuffs for a secure fit
- Concealed zip opening for added security
- Spacious pockets
- 7 pockets for ample storage
- 50+ UPF rated fabric to block 98% of UV rays

Part No.	Size	Qty	Price
765700	S	1	£26.21
765702	M	1	£26.21
765704	L	1	£26.21
765706	XL	1	£26.21
765708	2XL	1	£26.21
765710	3XL	1	£26.21

Navy Super Click Boilersuit



- 65% polyester, 35% cotton
- Concealed two-way zip
- 2 zip breast pockets
- Reinforced elasticated waist
- Double pen pocket on sleeve
- 2 swing hip pockets with side access
- 2 rear pockets, one with hook and loop fastening
- Knee pad pockets
- 1 rule pocket
- 1 hammer loop

Part No.	Size	Qty	Price
765656	36"	1	£22.15
765658	38"	1	£22.15
765660	40"	1	£22.15
765662	42"	1	£22.15
765664	44"	1	£22.15
765666	46"	1	£22.15
765668	48"	1	£22.15
765670	50"	1	£22.15
765672	52"	1	£22.15
765674	54"	1	£22.15

Black Thinsulate Beanie Hat



£3.76
Part No. 765477

Navy Beanie Hat with Rechargeable LED Head Light



£10.68
Part No. 765460

Navy Thermal Trousers



- Creates a layer of warmth around the lower body
- The soft poly-cotton fibres and fabric knitting mean that heat is trapped in
- Cuffed hem and elasticated waist provide a comfortable fit

Part No.	Size	Qty	Price
109006	S	1	£8.58
109007	M	1	£8.58
109008	L	1	£8.58
109009	XL	1	£8.58
109010	2XL	1	£8.58
109011	3XL	1	£8.58
109012	4XL	1	£8.58
109013	5XL	1	£8.58

Long Sleeve Navy Thermal T-shirt



- A long sleeve t-shirt cut that offers optimum warmth at all times
- The material construction allows the skin to breathe if conditions become too warm
- The round neck makes it ideal for wearing as an under-garment

Part No.	Size	Qty	Price
109000	S	1	£9.30
109014	M	1	£9.30
109015	L	1	£9.30
109001	XL	1	£9.30
109002	2XL	1	£9.30
109003	3XL	1	£9.30
109004	4XL	1	£9.30
109005	5XL	1	£9.30

Cleanstar Concentrated Screen Wash

- Powerful and concentrated screen wash
- Temperature resistant down to -52°C
- Contains no methanol and is environmentally friendly
- Will not cause damage to polycarbonate glass, car paint, windscreen wipers, window seals & windscreen washer pump
- Tested in accordance with ASTM 1177-07



Part No.	Description	Qty	Price
B416283	250ml	24	£20.42
B416284	500ml	24	£40.95

Premium Ice Scraper



£2.31
Part No. 700705

72 x 70ml Sachets All Seasons Screen Wash Bucket



- High power concentrate
- Removes dirt, grime and insect deposits
- Helps prevent freezing

£27.21
Part No. 610242

All Seasons Screen Wash



Part No.	Description	Qty	Price
610255	1L	1	£2.19
610248	5L	1	£5.04

De-Icer



- Powerful and fast acting
- Operates down to -15°C

Part No.	Description	Qty	Price
610500	500ml Trigger	12	£21.29
610285	600ml Aerosol	1	£1.71

Snow Shovels



£7.15
Part No. 990151

Aluminium Handled Shovel with Metal Edge



£16.20
Part No. 990152

400ml Motor Starter Spray



- Facilitates engine starting in cold, damp weather
- Ideal for jump starting when the battery is low
- Suitable for diesel and petrol engines with and without a catalyser

£6.94
Part No. B304504

200ml Rain-X Repellent



- Improves visibility by repelling rain, sleet & snow, as well as helping to prevent frost, bugs & road spray from sticking to the windscreen
- Helps improve visibility in wet conditions both day & night

£14.22
Part No. 610232

M.E.G 5ltr Antifreeze to BS6580



- Mono-ethylene glycol based antifreeze and coolant concentrate providing exceptional all year round protection and performance in all driving conditions

£15.82
Part No. 387794

Digital Thermometer Thermo Control III



- For fast and accurate non-contact measurement of surface temperature due to built-in laser pointer
- With data-hold function and auto power-off
- Equipped with backlit LCD display
- Compliant with IEC/EN 61010-1
- Measurement range: -50 to 550°C

£118.49
Part No. B215517

Multi Liquid Refractometer



- Accurately measures the strength of coolant, screen wash, battery fluid and AdBlue
- Supplied with pipette: result can be measured with one test drop
- Adjustable eyepiece
- Easy to read display
- Measurement range: -50 to 550°C

£59.40
Part No. B204773

Coolant Tester



- For accurate measurement of how diluted the coolant mixture is
- Suitable for ethanediol, ethylene glycol & water mixtures
- Features a temperature compensation rotor

£15.90
Part No. B140089

Screen Wash Antifreeze Tester



- For checking the antifreeze content in the windscreen washer fluid
- Instant reading of freezing point
- Suitable for isopropanol / ethanol water mixtures
- Measuring range of 0 to -30°C

£11.92
Part No. B140091

600v Digital-Multimeter



- Large measuring range
- Extra large back-light digital display
- With data 'hold' button
- Diode tester with optical and sound indicator
- Equipped with capacitors and capacitance measurement

£75.74
Part No. B185139

Battery Fluid Hydrometer



- For checking the density of battery fluid
- Clearly readable scale with colour indication

£11.78
Part No. B140092

Brake Fluid Tester



- Identifies percentage of water in brake fluid
- Suitable for DOT 3, 4 and 5.1

£45.95
Part No. B215220

Cooling System Pressure Tester



- High quality cooling system pressure tester with a comprehensive set of adaptor caps for HGV's
- Suitable for Volvo, MAN, Renault, DAF, Iveco, ERF & Scania
- Locates system leaks from header, expansion tanks and fittings, head gasket, radiator core, heater matrix, water pump, hoses, pipes, etc
- Adaptors have quick-release couplings and pump is fitted with large, easy to read dial clearly marked in both psi & bar
- Presented in an EVA foam tray & plastic case, convenient for user storage and limiting packaging waste

£393.56
Part No. BT005615

Oil Pressure Test Kit



- Gauge scale: 0-10 bar, 0-150psi
- Helps to diagnose worn oil pumps and engines, faulty oil pressure switches and pressure warning indicators
- Shock protected dual scale gauge, for quick and accurate oil pressure checks
- Permanently oil primed, long flexible hose, enables access to difficult to reach oil switch ports
- Small profile, quick coupling adaptors with built-in shut-off valve for fast secure connection
- Includes oil pressure test gauge c/w 1m oil primed hose and 10 x oil switch port adaptors
- Supplied in plastic case with foam insert

£241.12
Part No. 910360



6/12/24v Smart Workshop Battery Charger

- The charge is automatic/without supervision
- 50% shorter charge time compared to a traditional charger. Batiium ensures an ultra-quick and safe charge, by providing a constant average current during "boost" phase
- Batiium ensures a 100% charge of all lead-acid batteries (IwUoU curve). A standard "automatic" charger, W2 or WU curve, charges up to 90% only
- Batiium is a microprocessor controlled smart charger, that constantly analyses the state of the battery and regulates the charge according to the battery's needs
- Deeply discharged batteries that are still in a good state of health (eg lights on when the vehicle is stopped) could have a voltage as low as 1V. Batiium can charge from 1 volt, whereas most chargers cannot
- Protection of the on-board electronics. No need to disconnect the battery from the vehicle. No risk of sparks or short-circuits, and no current is supplied to the clamps unless they are connected to the battery terminals

£205.90

Part No. 260260

12/24v Smart CV Starter Charger

- Provides a constant voltage to ensure a complete and safe charge for every lead based battery - A standard old generation automatic charger charges batteries, in general, to 80% which is not enough to regenerate the battery
- Automatically activates when required and only provides current if the user activates vehicle's ignition
- Will automatically start a battery above 1V
- The timer function enables to manually set a charging time adjustable from 10 to 120 minutes. The charge stops automatically after the set-up time
- More than a charger-starter, these devices can determine the condition and performance of the vehicle charge system and can measure the alternator output voltage
- The product can stay connected safely with no supervision with automatic restart, in case of power failure
- Permanently analyses the health of the battery and regulate the charge according to the battery's needs
- Compatible with Start / Stop vehicle batteries



£941.09

Part No. 260262

24v Professional CV Lithium Booster Pack

- Anti-spark technology
- Short circuit protection
- Reverse polarity protection
- Protection against excessive starting currents
- Protection against booster temperature increases
- Lithium battery (LiFePO4) gives it an exceptional power-to-size ratio (starting current : 1400 A)
- It starts vehicles equipped with a discharged 24V battery (liquid, gel, AGM, Start&Stop) in a few seconds
- Equipped with: 2 USB 5V - 2.1A ports (for charging smartphone, tablet, GPS, etc) & 1 output port 12V - 3.5A (ideal for powering a 12 V electrical appliance)
- Has auxiliary light (28 LEDs) with 3 lighting modes: normal, strobe, SOS
- LCD display that gives information on the % of charge of the internal battery and the different input and output ports used

£693.15

Part No. 260266



12/24 Volt STARTpack Truck Starter and Power Supply

- Self Contained Starter - Instantaneously starts trucks, cars, camper vans, vans, petrol or diesel (Starting current 750A/3200A in 12V and 650A/1600A in 24V for peak current)
- Power Supply - The two integrated 22Ah batteries turn the STARTpack TRUCK into a powerful portable 12V DC power supply very useful for many electrical devices: TVs, lights, laptops, etc
- Integrated Light - Suitable for use at night or in low-light environments, the STARTpack TRUCK incorporates a light comprised of 7 powerful LEDs (7x 3.6W)
- Automatic charger 230V /12V Floating: to charge the internal battery unsupervised
 - Charge the battery up to 100%, maximising its life and efficiency
 - Can be left permanently to the main (Gyspack has to be charged after each operation)
- Integrated tester to check the level of charge of the internal battery
- ON/OFF switch button, to avoid misuse
- Alarm beep in case of reversed polarity
- Copper cables 2 x 1.80m, ø 25mm² with isolated 600 A clamps
- Equipped with an easily replaceable external fuse (replacement fuse included)
- Inside: 2 x 22Ah
- IV/C: 12V - 750A, 24V 650A
- Cranking CC: 12V - 1450A, 24V 1300A
- Peak Battery: 12V - 3200A, 24V 1600A

£475.90

Part No. 260270



12/24v CV Professional Booster Pack

- A professional autonomous starter for 12V and 24V lead batteries (liquid, AGM, EFB, gel) that starts vehicles in a few seconds: 1300A in 12V, 1200A in 24V
- Thanks to its 2 high-performance internal lead batteries, it develops a high starting current (up to 6200A peak)
- The booster integrates an intelligent charger that perfectly preserves the health of its 2 batteries
- Compact, robust and supplied with a trolley, it is ideal for breakdown services on site and in agricultural workshops, trucks, buses or for construction machinery
- Safe to use - protects on-board electronics, charger, battery and the user
- Avoids short circuits
- Protects against polarity inversion (with audible alarm + indicator light)
- Avoids sparks when connecting the clamps

£1,428.35

Part No. 260264



50mm² x 5.1m Heavy Duty Professional Jump Leads



£252.25

Part No. 260268

35mm² x 5m Jump Leads



£70.06

Part No. 512229

Red and Black Heavy Duty Jump Lead Clips



£18.31

Part No. 512222

20-40" Wiper Blades

- Stainless Steel construction - corrosion resistant
- Heavy duty riveted joints for extra strength & reduced noise
- Selection of adaptors for each part number
- Quick and easy installation
- 100% natural rubber injection moulded to correct length
- All blades boxed individually

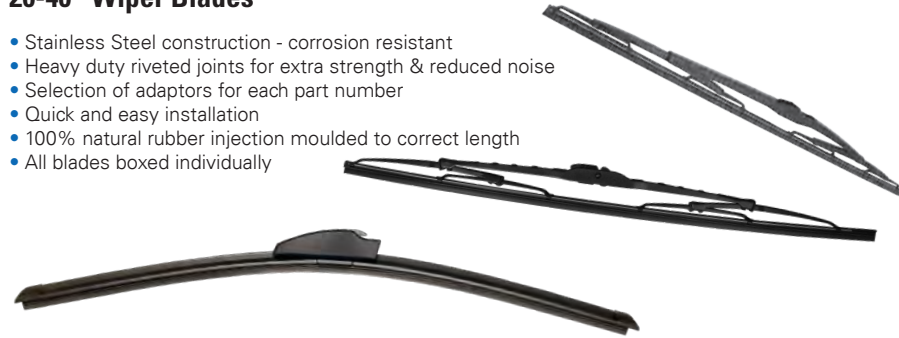

Part No.	Description	Adaptor Fitting	Qty	Price
B047433	20" 510mm 8x3, 9x3, 9x4 Hook Wiper Blade	8x3, 9x3, 9x4 Hook	1	£7.99
B047435	22" 550mm Bolt Type 2 Holes 13,6-16 Wiper Blade	Bolt Type 2 Holes 13, 6-16 with Spacer	1	£7.63
B047439	24" 600mm Hook Type (12x4, 9x4) Wiper Blade	12x4, 9x4, 9x4 Short Hook	1	£7.37
B047438	24" 600mm with Washer Nozzle Wiper Blade	Spray Nozzle + Multi-fit Adaptor	1	£8.14
B047447	26" 650mm Bolt Type 2 Holes 13,6-16 Wiper Blade	Bolt Type 2 Holes 13, 6-16 with Spacer	1	£8.62
B047440	26" 650mm Hook Type (12x4, 9x4) Wiper Blade	12x4, 9x4, 9x4 Short Hook	1	£7.37
B047448	26" 650mm with Washer Nozzle Wiper Blade	Spray Nozzle + Multi-fit Adaptor	1	£9.45
B047442	28" 700mm 12x4, 9x4 Hook Wiper Blade	12x4, 9x4, 9x4 Short Hook	1	£9.24
B047441	28" 700mm Bolt Type 2 Holes 13,6-16 Wiper Blade	Bolt Type 2 Holes 13, 6-16 with Spacer	1	£9.45
B047449	28" 700mm with Washer Nozzle Wiper Blade	Spray Nozzle + 12x4, 9x4, 9x4 Short Hook	1	£10.34
B047443	32" 800mm 25/27mm Bolt Type Wiper Blade	Bolt Type 25/27mm with Spacer	1	£11.59
B047444	36" 900mm 25/27mm Bolt Type Wiper Blade	Bolt type 25/27mm with Spacer	1	£15.39
B047450	36" 900mm 16x6 Hook Type Wiper Blade	16x6mm Hook Adaptor pre-mounted	1	£14.94
B047446	40" 1000mm 22/25/27mm Bolt Type Wiper Blade	Bolt Type 22/25/27mm	1	£16.58
B047445	40" 1000mm 16x6 Hook Type Wiper Blade	16x6mm Hook Adaptor pre-mounted	1	£16.48

8 Hook Wiper Blade Holder

- Clear presentation of the windscreen wipers
- Easy and organised storage
- 100mm long



£25.44

Part No. B551368

PVC Universal Clear Windscreen Washer Tubing



- Operating temperature: -20 to 70°C

Part No.	Description	Qty	Price
B365483	4mm ID x 15m	1	£14.98
B365491	5mm ID x 15m	1	£15.50
B365513	6mm ID x 15m	1	£16.37
B365521	8mm ID x 15m	1	£18.26

Straight Tube Connectors



Part No.	Description	Qty	Price
B003580-25	3mm	25	£14.89
B869797-25	4mm	25	£16.38
B869803-25	5mm	25	£18.19
B814210-25	6mm	25	£20.39

390 x 190mm Convex Mirror Head



£23.14

Part No. 626630

384 x 184mm Twin Lens Mirror Head



£42.87

Part No. 626655

245 x 162mm Wide Angle Shatter Proof Mirror Head



£28.51

Part No. 626568

383 x 193mm Convex External Mirror Head



£19.79

Part No. 626624

Mirror Arms



Part No.	Description	Qty	Price
487549	828 x 716mm N/S	1	£103.53
487553	610 X 410mm N/S	1	£98.63
487552	550 X 213mm O/S	1	£90.79

Compact Classic Windscreen Repair Kit



- 12 volt only system
- Suitable for stone chips and short cracks in laminated windcreens

£438.90

Part No. 777620

Extra Long Flat Serrated Blade Wk1Sc



- For cutting below deep dashboards & long reach applications

£56.63

Part No. 777642

SikaTack® MOVE Transportation Black



- Cold-applied 1-component polyurethane system
- Black primerless
- Excellent weather and cleaning agent resistance
- Provides good UV-resistance
- Excellent application and non-sag properties
- Optimal open time for large or heavy windcreens
- Prevents contact corrosion in aluminium-bodied vehicles
- Solvent-free
- Shortest Safe Drive-Away Times
- 600cc Black

£19.13

Part No. 482555

BUILDING TRUST



Elite Windscreen Repair Kit with UV Lamp



- Provides professional quality repairs consistently with maximum ease of use
- Want to carry out repairs outdoors? No need for an inverter; it's a 12v volt kit
- Need to do repairs in a workshop? Then no need to look for a 12v source, the included power supply unit makes it a mains powered kit - easy
- The new LED lamp cures in 75 seconds making repairing even quicker

£757.90

Part No. 777622

B0601 Bohle Glass Sucker

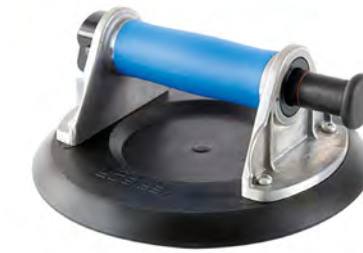

- Load Capacity - 120kg
- Suction Pad - Ø213mm
- Pump-activated suction lifter made of sturdy aluminium with high load capacity for handling large objects
- Handle with non-slip coating
- Rounded pump tappet enables quick and easy operation and the red ring on the pump tappet enables permanent visual monitoring of the vacuum
- The suction lifter lends itself to all materials with flat, airtight surfaces. The high quality of the suction lifter has been confirmed by TÜV (German Technical Inspection Agency) by granting it the GS sign

£182.27

Part No. 810670

Heavy-Duty Wiper Arm Puller



Saves the price of a new windscreen

- Heavy-duty construction with locking feature allowing the tool to be fastened securely to the wiper arm before commencing pull
- Also suitable for battery terminal and alternator bearing removal

£20.95

Part No. VS807

Heatshrink Tubing Kit - Black

- Shrink Ratio: 2:1
- Shrink Temperature: 115°C
- Temperature range from: -55 to 135°C
- Resistant to chemicals & solvents

Contents

- 2.4mm x 10m
- 3.2mm x 10m
- 4.8mm x 10m
- 9.5mm x 5m
- 12.7mm x 5m
- Dispenser for 5 rolls

£64.20

Part No. B510324



50mm x 50m Aloxide Brown Emery Rolls

- For metal and wood

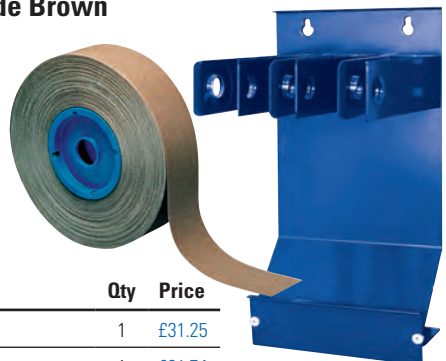

Part No.	Description	Qty	Price
B050596	60G	1	£31.25
B050597	80G	1	£31.74
B050598	100G	1	£28.18
B050599	120G	1	£27.17
B050602	240G	1	£27.96
B100099	Dispenser	1	£43.14

Fuel Hose Dispenser c/w Special Hose Shears

- For easy storing and dispensing of fuel hoses
- Locking device: prevents automatic unrolling
- Includes attached shears

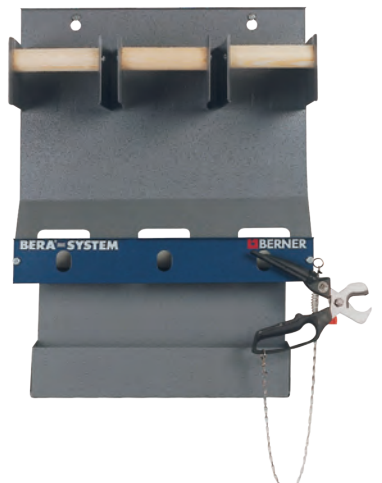

£94.58

Part No. B115010

BUY 3 OR 5 ASSORTMENTS AND RECEIVE A 3 OR 5 DRAWER CABINET FREE

- Lockable
- Stackable
- Can be wall mounted

3 Drawer Part No. 159331 Worth **£106.05**
5 Drawer Part No. 159332 Worth **£125.64**



Chemical Starter Pack

- For all your degreasing, lubricating, protecting and sealing needs
- Includes a variety of our chemicals allowing you to sample the high quality products they are at a price that is great value for money

Contents

- 4x 400ml Universal White Grease Spray
- 4x 400ml Super 6+ Multi Spray
- 4x 400ml Silicone Grease Spray
- 4x 500ml Brake Cleaner
- 4x 400ml Copper Lubricant Spray
- 2x 200ml Black Liquid Gasket

Part No. 750805

Only £108.90

FREE TORCH WORTH £39.61



Conversion Factors

From	To	Metric Units	Multiply by
Inches	Millimetres	mm	25.4
Feet	Metres	m	0.305
Yards	Metres	m	0.914
Miles	Kilometres	km	1.609
Square inches	Square centimetres	cm ²	6.452
Square feet	Square metres	m ²	0.093
Square yards	Square metres	m ²	0.836
Square miles	Square kilometres	km ²	2.590
Cubic inches	Cubic centimetres	cm ³	16.387
Cubic feet	Cubic metres	m ³	0.028
Cubic yards	Cubic metres	m ³	0.765
Pints	Litres	ltr	0.568
Imperial Gallons	Litres	ltr	4.546
Ounces	Grams	g	28.35
Pounds	Kilograms	kg	0.454
Tons	Tonnes (1000kg)	t	1.016
Lb/sq.in.	Kg/sq.m	kg/m ²	703.07
Cubic feet/min	Litres/min	ltr/min	28.32
Lb.ft	Nm	Nm	1.36
psi	Bar	bar	0.0689

Socket Size Conversions

Imperial	Metric
5/32"	4mm
7/32"	5.5mm
5/16"	8mm
7/16"	11mm
15/32"	12mm
19/32"	15mm
5/8"	16mm
3/4"	19mm
25/32"	20mm
13/16"	21mm
7/8"	22mm
15/16"	24mm
1-1/16"	27mm
1-3/16"	30mm
1-1/4"	32mm
1-5/16"	33mm
1-3/8"	35mm
1-1/2"	38mm
1-9/16"	40mm
1-5/8"	41mm
1-11/16"	43mm
1-13/16"	46mm
1-7/8"	48mm
2-1/16"	52mm
2-1/8"	54mm
2-3/16"	55mm
2-1/4"	57mm
2-3/8"	60mm
2-1/2"	63mm
2-9/16"	65mm
2-5/8"	67mm
2-3/4"	70mm
2-13/16"	71mm
2-15/16"	75mm
3-1/8"	80mm
3-3/4"	95mm

Metric Thread Pitch Sizes

Hex Key/Socket Size Guide

Size	Pitch
M3	0.50mm
M4	0.70mm
M5	0.80mm
M6	1.00mm
M7	1.00mm
M8	1.25mm
M10	1.50mm
M12	1.75mm
M14	2.00mm
M16	2.00mm
M18	2.50mm
M20	2.50mm
M22	2.50mm
M24	3.00mm

Thread Size	Hex Size
M3	2.5mm
M4	3mm
M5	4mm
M6	5mm
M8	6mm
M10	8mm
M12	10mm
M16	14mm
M20	17mm
M24	19mm

Tap Drills & Scew Thread Chart - preferred thread series

Nominal Ø of threads in mm.	Pitch in mm.	Tapping Drill Ø in mm.
M2.0	0.25	1.75
M2.0	0.40	1.60
M2.2	0.25	1.95
M2.2	0.45	1.75
M2.5	0.35	2.15
M2.5	0.45	2.05
M3.0	0.35	2.65
M3.0	0.50	2.50
M3.5	0.35	3.15
M3.5	0.60	2.90
M4.0	0.50	3.50
M4.0	0.70	3.30
M4.5	0.50	4.00
M4.5	0.75	3.70
M5.0	0.50	4.50
M5.0	0.80	4.20
M6.0	0.75	5.20
M6.0	1.00	5.00
M7.0	0.75	6.20
M7.0	1.00	6.00
M8.0	0.75	7.20
M8.0	1.00	7.00
M8.0	1.25	6.80
M9.0	0.75	8.20
M9.0	1.00	8.00
M9.0	1.25	7.80
M10.0	1.00	9.00
M10.0	1.25	8.80
M10.0	1.50	8.50
M11.0	1.00	10.00
M11.0	1.50	9.50
M12.0	1.00	11.00
M12.0	1.25	10.80
M12.0	1.50	10.50
M12.0	1.75	10.20
M14.0	1.00	13.00
M14.0	1.25	12.80
M14.0	1.50	12.50
M14.0	2.00	12.00
M16.0	1.00	15.00
M16.0	1.50	14.50
M16.0	2.00	14.00
M18.0	1.00	17.00

Nominal Ø of threads in mm.	Pitch in mm.	Tapping Drill Ø in mm.
M18.0	1.50	16.50
M18.0	2.00	16.00
M18.0	2.50	15.50
M20.0	1.00	19.00
M20.0	1.50	18.50
M20.0	2.00	18.00
M20.0	2.50	17.50
M22.0	1.00	21.00
M22.0	1.50	20.50
M22.0	2.00	20.00
M22.0	2.50	19.50
M24.0	1.00	23.00
M24.0	1.50	22.50
M24.0	2.00	22.00
M24.0	3.00	21.00
M25.0	1.50	23.50
M25.0	2.00	23.00
M27.0	1.50	25.50
M27.0	3.00	24.00
M28.0	1.50	26.50
M30.0	1.50	28.50
M30.0	3.50	26.50
M32.0	1.50	30.50
M33.0	2.00	31.00
M33.0	3.50	29.50
M36.0	3.00	33.00
M36.0	4.00	32.00
M39.0	3.00	36.00
M39.0	4.00	35.00
M40.0	1.50	37.50
M40.0	3.00	37.00
M42.0	4.00	38.00
M42.0	4.50	37.50
M45.0	4.00	41.00
M45.0	4.50	40.50
M48.0	4.00	44.00
M48.0	5.00	43.00
M52.0	4.00	48.00
M52.0	5.00	47.00
M56.0	4.00	52.00
M56.0	5.50	50.50
M60.0	4.00	56.00
M60.0	5.50	54.50

Screw Gauge Conversion

Gauge	Metric Ø (mm)	Imperial Ø (inch)
0g	1.5mm	1/16"
1g	1.9mm	5/64"
2g	2.25mm	3/32"
3g	2.5mm	13/128"
4g	2.58mm	7/64"
5g	3.3mm	1/8"
6g	3.5mm	9/64"
7g	3.9mm	5/32"
8g	4.2mm	11/64"
9g	4.5mm	23/128"
10g	4.8mm	3/16"
12g	5.5mm	7/32"
13g	6.1mm	15/64"
14g	6.3mm	1/4"
15g	6.5mm	1/4"
16g	6.8mm	17/64"
18g	7.5mm	19/64"
20g	8.1mm	21/64"
24g	9.4mm	3/8"

Size Conversion

Imperial (inch)	Metric (mm)	Imperial (inch)	Metric (mm)	Imperial (inch)	Metric (mm)
1/64"	0.40	45/64"	17.86	7"	177.80 (180)
1/32"	0.79	23/32"	18.26	7-1/2"	190.50 (190)
3/64"	1.19	47/64"	18.65	8"	203.20 (200)
1/16"	1.59	3/4"	19.05 (19.0)	8-1/2"	215.90 (215)
5/64"	1.98	49/64"	19.45	9"	228.60 (230)
3/32"	2.38	25/32"	19.84	9-1/2"	241.30 (240)
7/64"	2.78	51/64"	20.24	10"	254.00 (250/255)
1/8"	3.17 (3.0)	13/16"	20.64	11"	279.40 (280)
9/64"	3.57	53/64"	21.03	12"	304.80 (305)
5/32"	3.97 (4.0)	27/32"	21.43	13"	330.20 (330)
11/64"	4.37	55/64"	21.83	14"	355.60 (350/355)
3/16"	4.76 (5.0)	7/8"	22.23 (22.0)	15"	381.00 (380)
13/64"	5.16	57/64"	22.62	16"	406.40 (400/405)
7/32"	5.56	29/32"	23.02	18"	457.20 (455/460)
15/64"	5.95	59/64"	23.42		
1/4"	6.35 (6/6.5)	15/16"	23.81		
17/64"	6.75	61/64"	24.21		
9/32"	7.14	31/32"	24.61		
19/64"	7.54	63/64"	25.00		
5/16"	7.94 (8.0)	1"	24.50 (25.0)		
21/64"	8.33	1-1/16"	26.99		
11/32"	8.73	1-3/32"	27.78		
23/64"	9.13	1-1/8"	28.58 (28.0)		
3/8"	9.52 (10.0)	1-5/32"	29.37		
25/64"	9.92	1-3/16"	30.16 (30.0)		
13/32"	10.32	1-7/32"	30.96		
27/64"	10.72	1-1/4"	31.75 (32.0)		
7/16"	11.11	1-1/2"	38.10 (38.0)		
29/64"	11.51	1-3/4"	45.45 (45.0)		
15/32"	11.91	2"	50.80 (50.0)		
31/64"	12.30	2-1/4"	57.15 (57.0)		
1/2"	12.70 (13.0)	2-1/2"	63.50 (65.0)		
17/32"	13.49	2-3/4"	69.85 (70.0)		
35/64"	13.89	3"	76.20 (75.0)		
9/16"	14.29 (14.0)	3-1/4"	82.55 (82.0)		
37/64"	14.68	3-1/2"	88.90 (90.0)		
19/32"	15.08	3-3/4"	95.25 (95.0)		
39/64"	15.48	4"	101.60 (100)		
5/8"	15.88 (16.0)	4-1/2"	114.30 (115)		
41/64"	16.27	5"	127.00 (125)		
21/32"	16.67	5-1/2"	139.70 (140)		
43/64"	17.06	6"	152.40 (150)		
11/16"	17.46	6-1/2"	165.10 (165)		

Bulb	Part No.	Description	Qty	Price
149	B180025-10	24v 5w Bulb	10	£2.17
149HD	B154130-10	24v 5w BA15s Heavy Duty Bulb	10	£4.93
207	B154120-10	12v 5w Bulb	10	£2.41
207LL	B148327-10	12v 5w BA15s Long Life Bulb	10	£3.91
209	110232	12v 5w Bulb	10	£2.83
227	110234	24v 6w MCC Bulb	10	£2.38
233	B179973-10	12v 4w Bulb	10	£2.45
239	B179949-10	12v 5w Festoon Bulb	10	£2.15
241	B181650-10	24v 21w Bulb BA15s	10	£2.79
241HD	B251534-10	24v 21w BA15s Heavy Duty Bulb	10	£5.23
242	B179965-10	24v 5w Festoon Bulb	10	£2.63
245	110245	12v 10w Bulb	10	£2.48
246	B180017-10	24v 10w Bulb	10	£2.07
247	110249	24v 5w Bulb	10	£4.60
249	B179990-10	24v 4w Bulb	10	£2.30
256	B368067-10	12v 3w 7.5 x 36mm Festoon Bulb	10	£1.38
260	110262	24v 5w 11 x 43mm Festoon Bulb	10	£3.67
265	110263	12v 10w Festoon 11 x 43mm Bulb	10	£3.31
270	B179850	12v 18w Festoon Bulbs 15 x 44mm	10	£5.95
272	110717	12v 10w Festoon Bulb	10	£2.95
273	110264	12v 21w Festoon 15x43mm Bulb	10	£4.54
274	110267	24v 10w Festoon 11 x 38mm Bulb	10	£1.86
276	110269	24v 15w Festoon 15/43mm Bulb	10	£4.32
281	110274	Bulb 12v 2w BA7 Bulb	10	£2.17
286	B190012-10	12v 1.2w w2 x 4,6D Wedge T5 Bulb	10	£1.97
289	110282	24v 2w Bulb	10	£1.95
291	110284	24v 21w Bulb	10	£4.42
296	B251569-10	24v 4w BA9s Heavy Duty Bulb	10	£3.91
330	110286	24v 44w DC BPF Bulb	10	£10.27
333	110290	24v 24w Bulb	10	£4.37
334	110294	24v 21/5w Bulb	10	£3.31
335	110298	12v 21w SBC Bulb	10	£2.92
339	110300	24v 24w Bulb	10	£2.66
346	110314	24v 21w Bulb	10	£2.89
380	110318	12v 21/5w Bulb	10	£2.72
380W	B144357-10	12v 21/5w w3 Wedge Base Bulb	10	£8.25
381	110320	12v 21/5w Bulb	10	£4.30
382	B154148-10	12v 21w Bulb	10	£2.02
382A	B171082-10	12V 21W BA15S Orange Bulb	10	£2.53
382W	B144358-10	12v 21w w3 Wedge Base Bulb	10	£7.58
382WA	B000581-10	12v 21w w3 Orange Wedge Base Bulb	10	£11.55
433C	B112938-10	12v 5w Miniature Halogen Bulb BA9s	10	£22.72
433D	B165189-10	12v 21w Miniature Halogen Bulb BAY9s	10	£17.44
433E	110301	24v 21w BAY9S Halogen Bulb	10	£17.18

Bulb	Part No.	Description	Qty	Price
434F	110333	24v 10w G4 Halogen Bulb	10	£16.01
437	110334	24v 54/44w DC BPF Bulb	10	£11.32
448	B179868-10	12v 55w H1 Bulb	10	£13.18
448HD	B098180-10	12v 55w H1 P14.5s PREMIUM Bulb	10	£25.80
453	B179884-10	12v 55w H3 Bulb	10	£14.60
453	B098182-10	12v 55w H3 PREMIUM Bulb	10	£11.52
460	B179892-10	24v 70w H3 Bulb	10	£14.05
460HD	B011908-10	24v 70w H3 Heavy Duty Bulb	10	£23.65
466	B179876-10	24v 70w H1 Bulb	10	£20.25
466HD	B011902-10	24v 70w H1 Heavy Duty Bulb	10	£32.40
472	B080891-10	12v 55w H4 Bulb	10	£18.10
472	B098185-10	12v 55w H4 PREMIUM Bulb	10	£17.13
472CP	110737	12v 60/55w Cobalt Blue H4 Bulb	1	£5.20
475	B011909-10	24v 75/70w H4 Heavy Duty Bulb	10	£26.53
491	110378	24v 100w H1 Bulb	10	£28.11
493	110373	24v 100w H3 Bulb	10	£32.43
499	B180838-10	12v 55w Halogen Xenon H7 Bulb	10	£22.09
499	110748	12v 55w Superblue H7 GE Bulb	1	£3.52
499	B098188-10	12v 55w Halogen Xenon PREMIUM H7 Bulb	10	£19.60
499A	B121420-10	24v 70w Xenon H7 Bulb	10	£38.13
499A	110369	24v 70w Xenon H7 Bulb	1	£3.94
499ALL	B172043-10	24v 70w H7 HD Long-life Headlamp Bulb	10	£32.89
499AC	9-84343	24v 70w H7 Superblue Bulb	1	£2.20
501	110374	12v 5w Capless Bulb	10	£2.17
504	B154164-10	12v 3w w2 Wedge Base Bulb	10	£0.78
505	B154180-10	24v 3w Wedge W2,1 x 9,5D Bulb	10	£2.05
507	B154199-10	24v 5w Wedge Bulb W2,1 x 9,5D E1	10	£2.00
508T	110390	24v 1.2w Tacho c/w Grey Holder GE Bulb	10	£4.90
508TVB	110426	24v 1.2w Tacho Brown Base Bulb	10	£7.08
508TVV	110394	24v 1.2w Tacho c/w Yellow Base Bulb	10	£7.89
566	110720	12v 21/4w SBC BAZ15D Bulb	10	£4.03
566A	110385	24v 21/4w BAZ15D Bulb	10	£7.24
571	110486	24v 20w 2-pin Bulb	10	£12.43
581A	B150655-10	24v 21w Amber Bulb	10	£7.95
687	110397	24v 1.5w LES E5 Bulb	10	£4.47
651	110392	24V 2.8W MCC 15mm Bulb	10	£2.64
695	110400	24v 2.8w E10/13 MES Bulb	10	£1.10
865	110416	24v 2.8w Bulb	10	£1.00
921	110422	12v 20w Capless Bulb	10	£4.90
993	110425	24v 2.8w E10/13 MES Bulb	10	£2.87
1056	B154156-10	12v 21w Amber Bulb	10	£7.80
H8	B174487	12v 35w Halogen Xenon H8 Bulb PGJ19-1	1	£3.59
H9	B174488	12v 65w Halogen Xenon H9 Bulb PGJ19-5	1	£3.59
H11	B174489	12v 55w Halogen Xenon H11 Bulb PGJ19-2	1	£3.59
H15	B098739	12v 15/55w Halogen Xenon H15 Bulb PGJ23t-1	1	£9.74
H16	B216487	12v 19w Halogen Xenon H16 Bulb PGJ19-3	1	£4.92
HB4	B144003	12v 19w Halogen Xenon H16 Bulb PGJ19-3	1	£2.56

